

hama®

THE SMART SOLUTION

XX
050453

Keyboard

ROSSANO

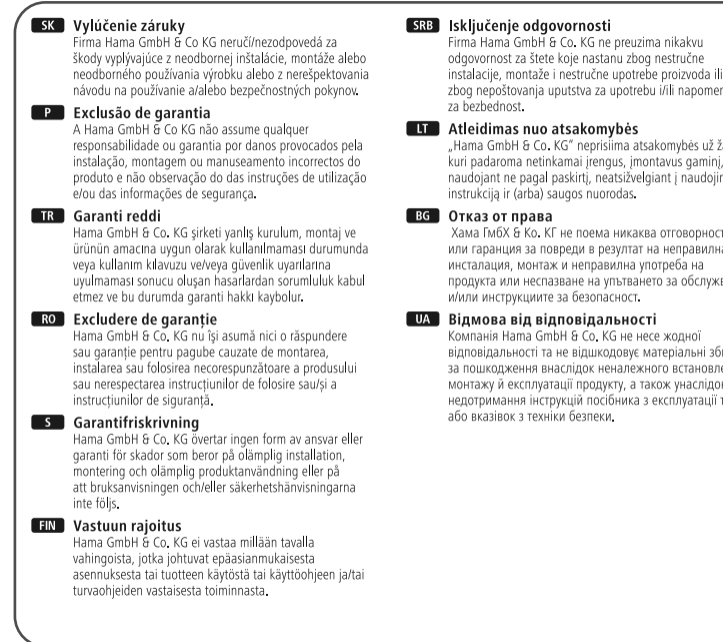
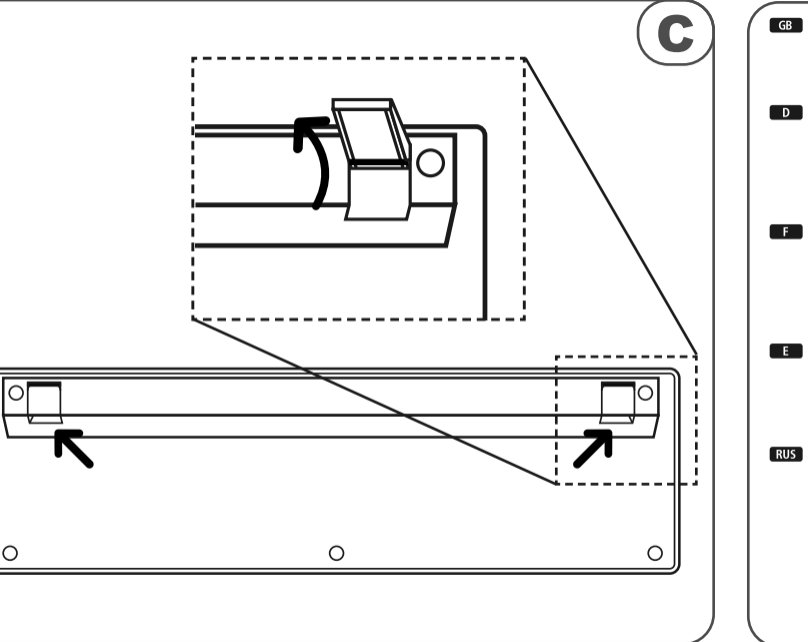
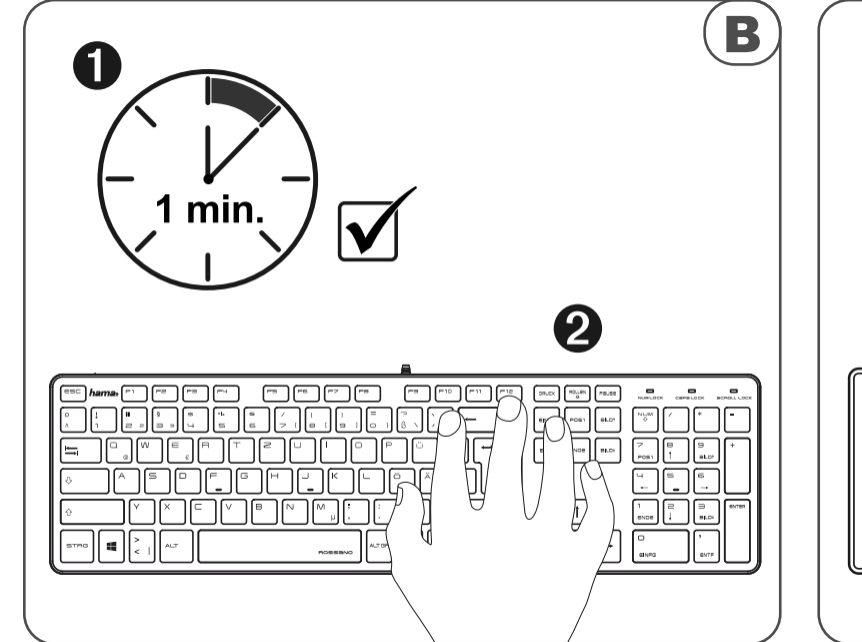
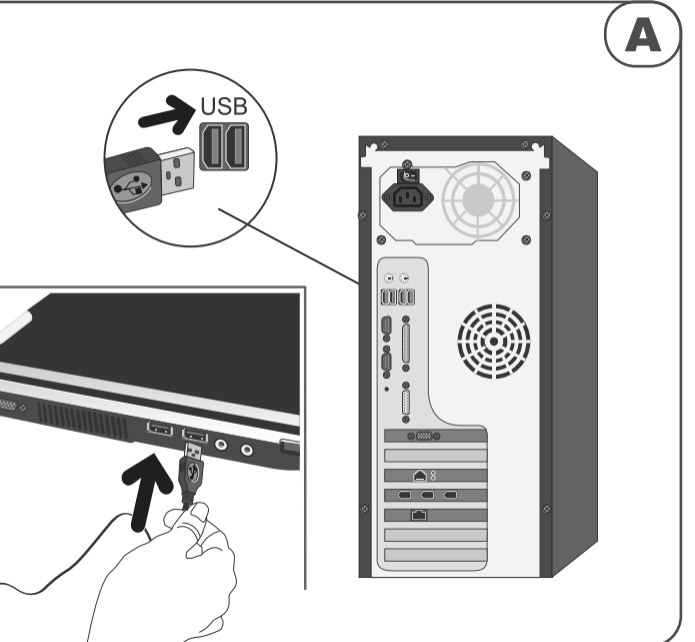
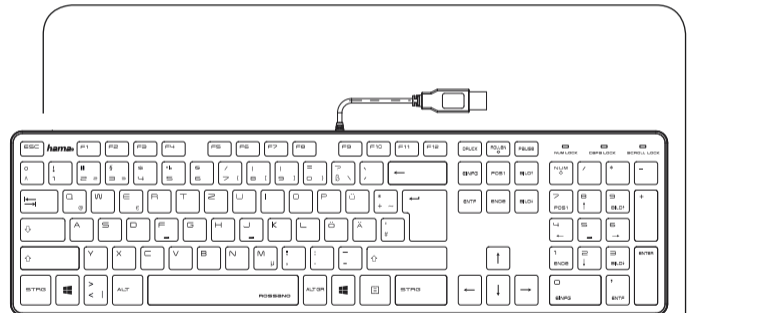

A

B

C

1

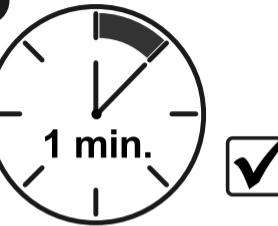

2

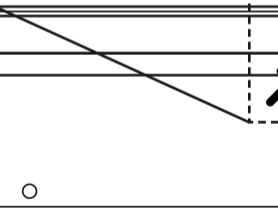
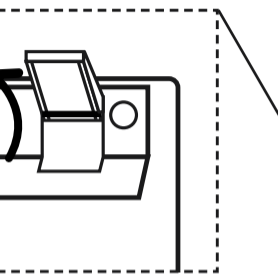
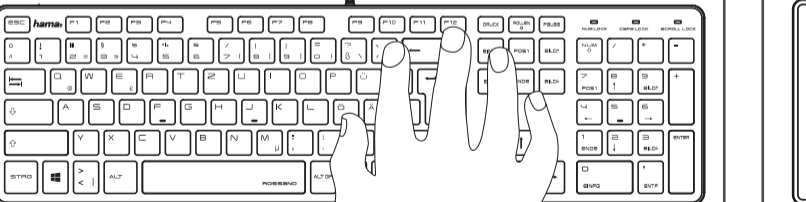

1

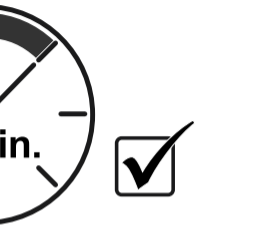

2

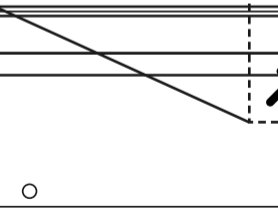
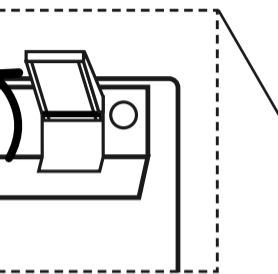
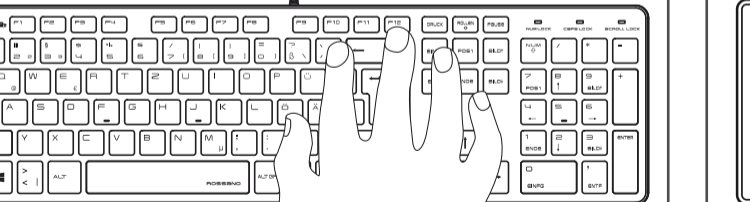

1

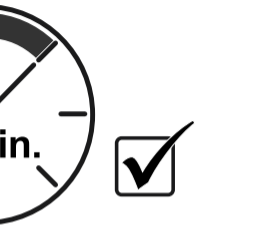

2

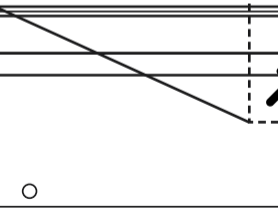
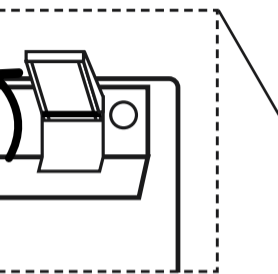
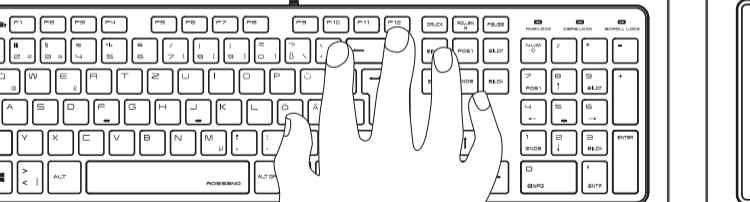

1

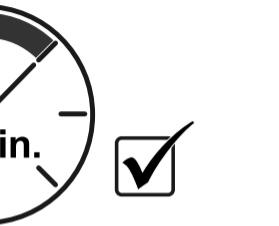

2

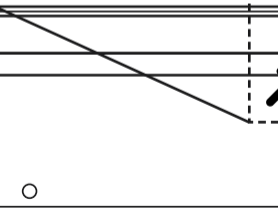
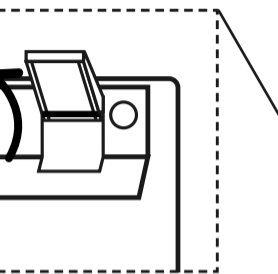
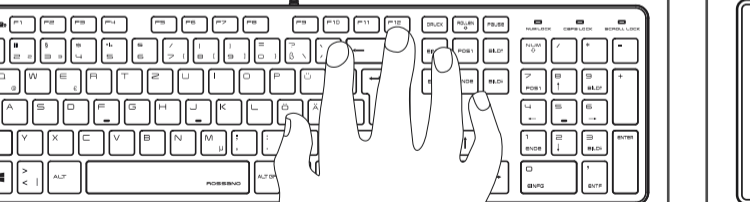

1

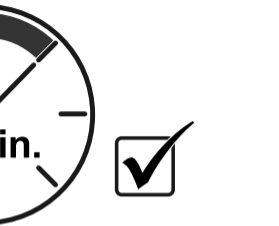

2

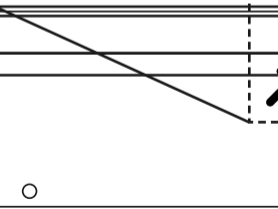
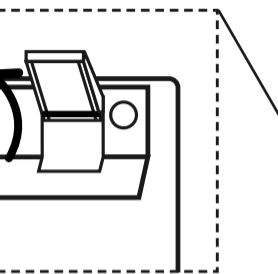
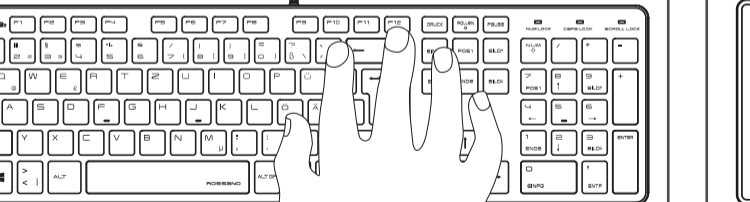

1

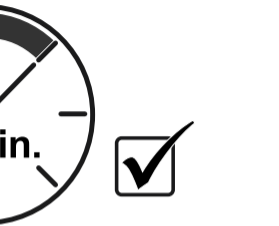

2

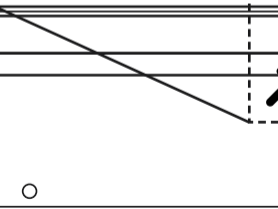
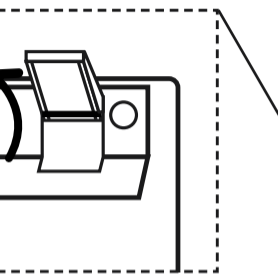
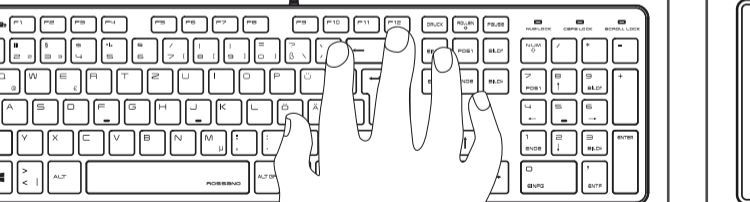

1

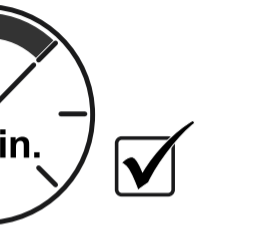

2

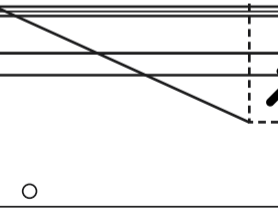
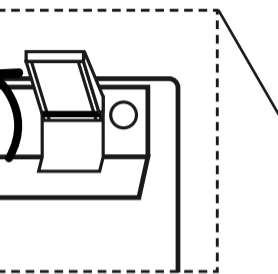
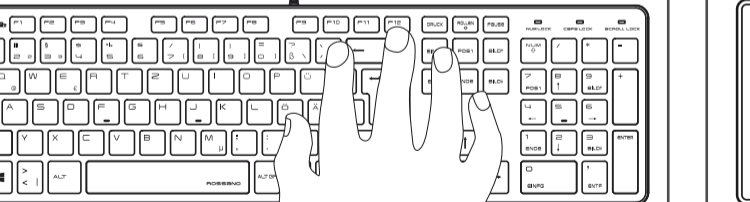

1

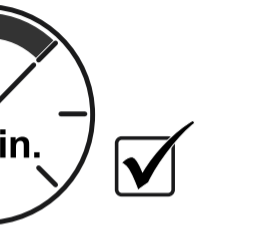

2

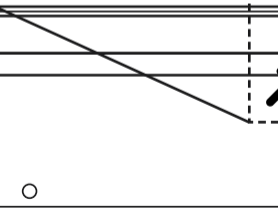
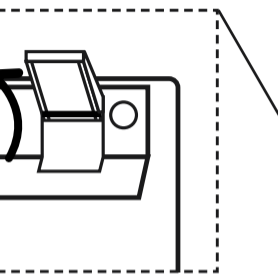
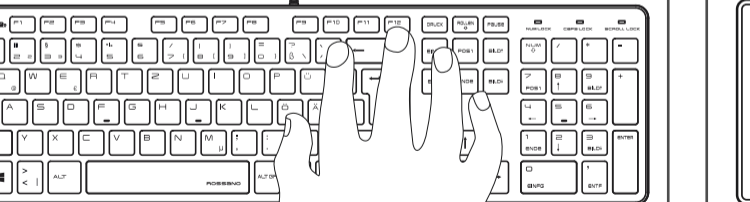

1

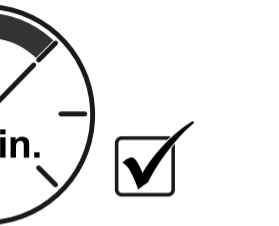

2

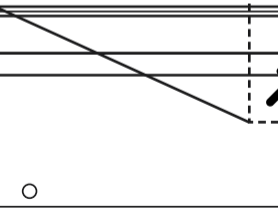
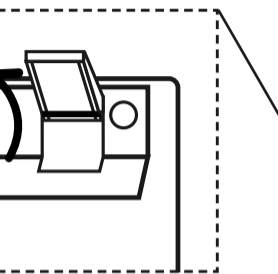
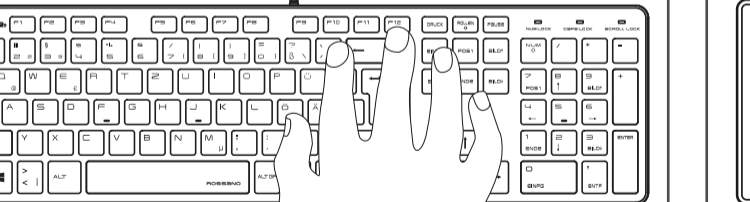

1

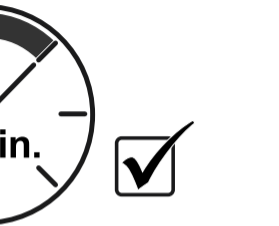

2

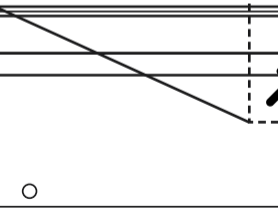
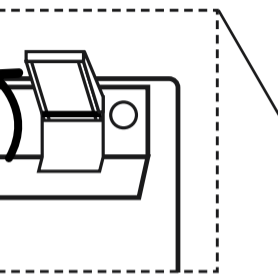
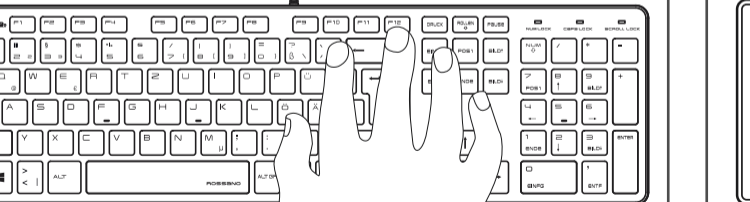

1

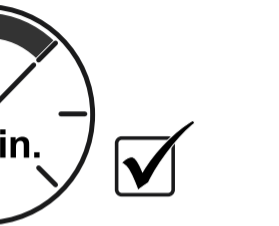

2

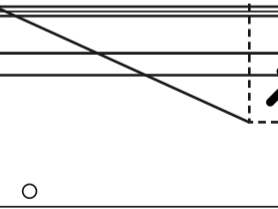
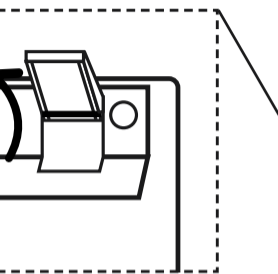
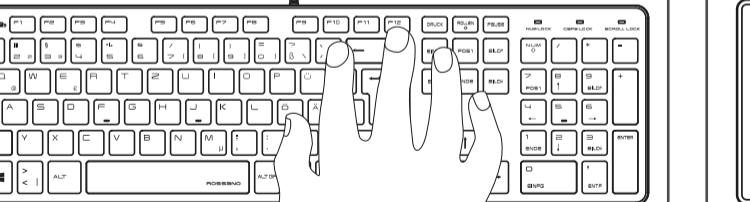

1

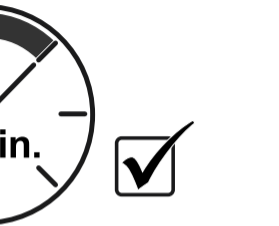

2

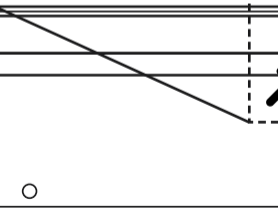
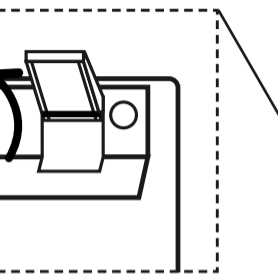
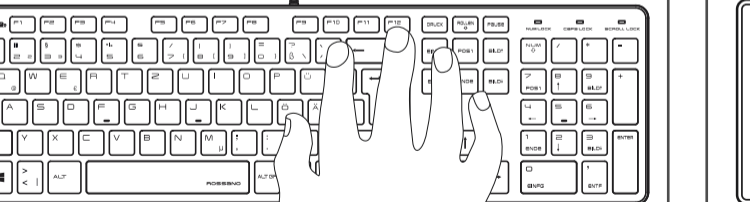

1

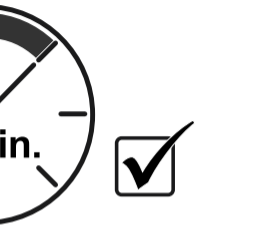

2

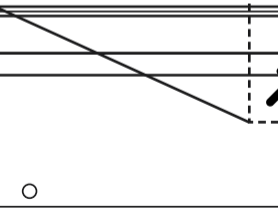
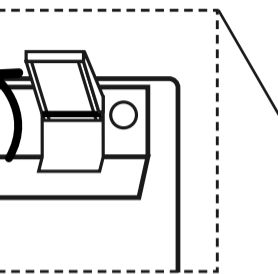
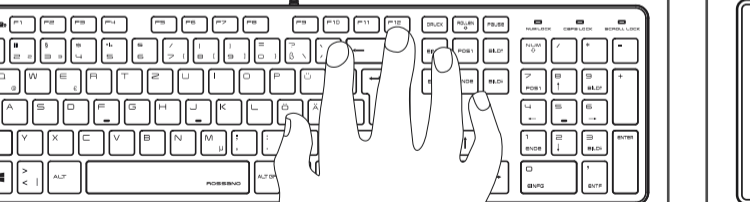

1

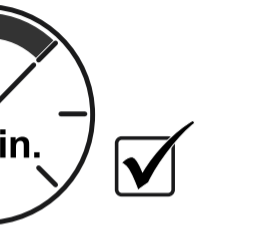

2

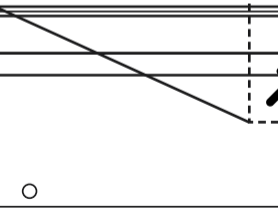
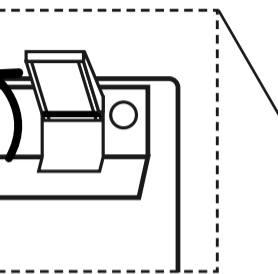
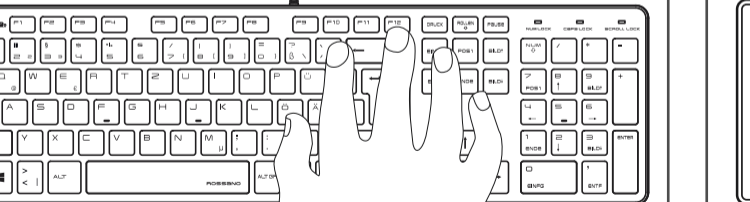

1

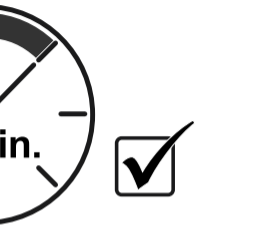

2

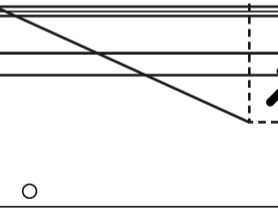
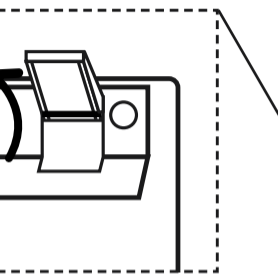
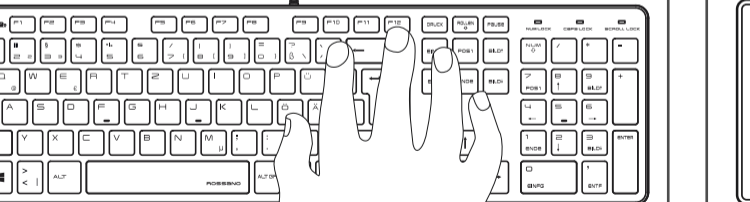

1

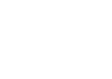
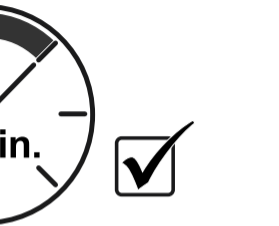

2

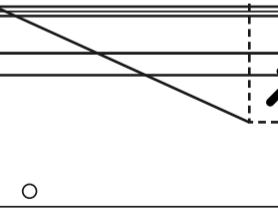
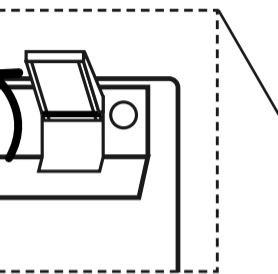
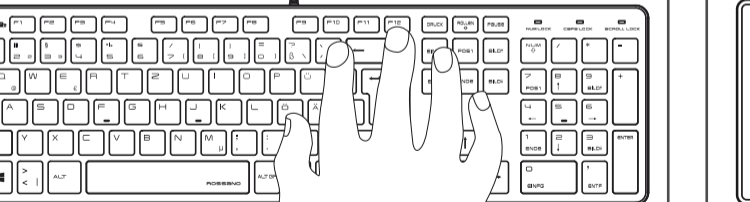

1

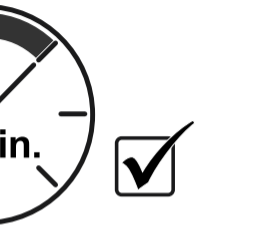

2

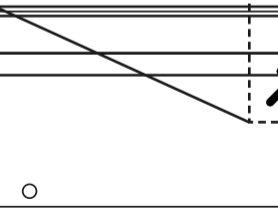
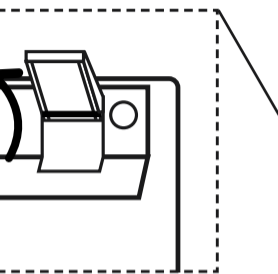
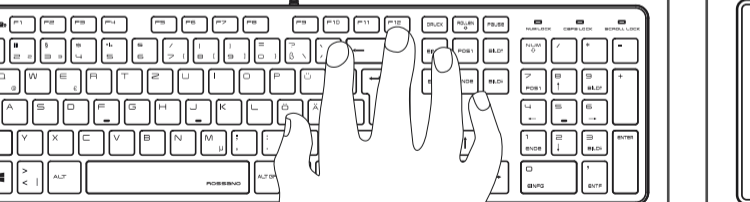

1

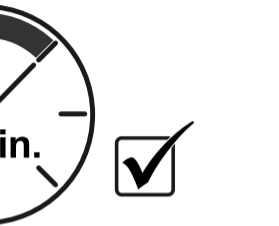

2

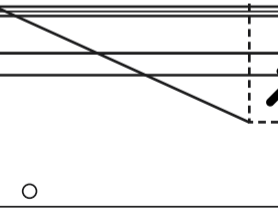
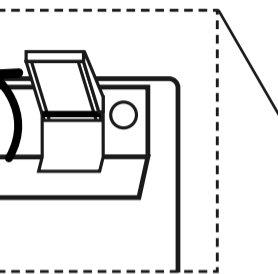
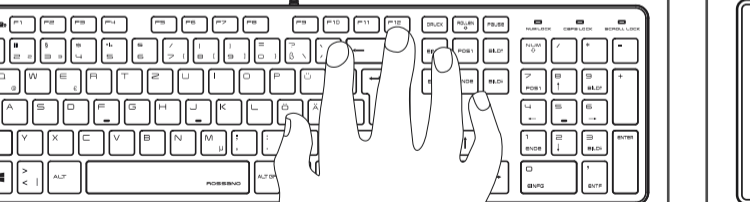

1

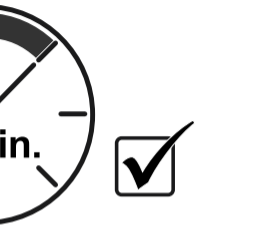

2

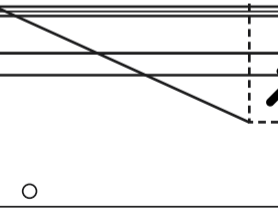
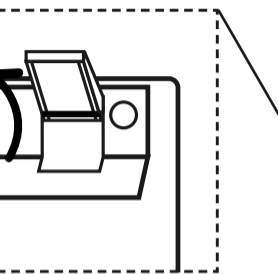
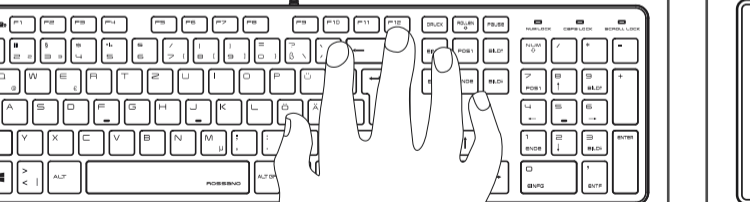

1

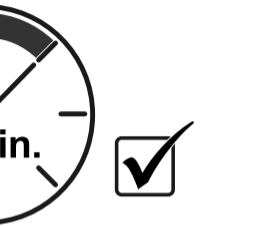

2

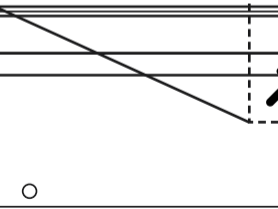
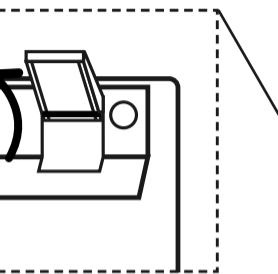
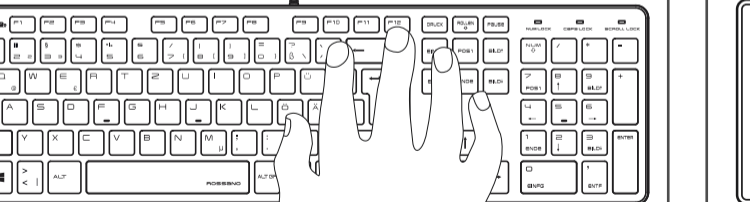

1

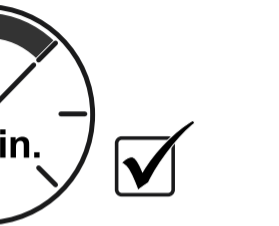

2

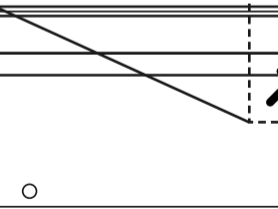
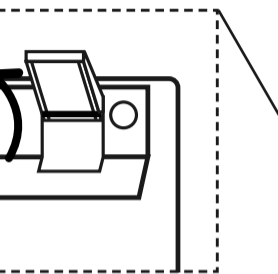
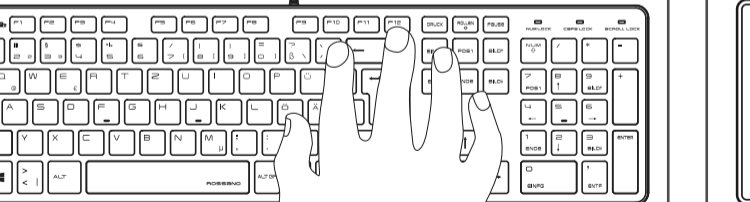

1

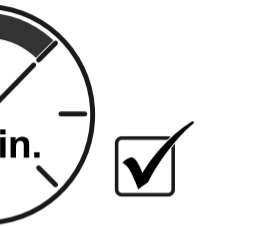

2

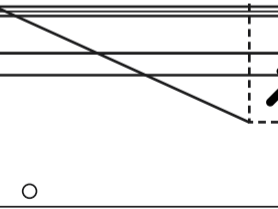
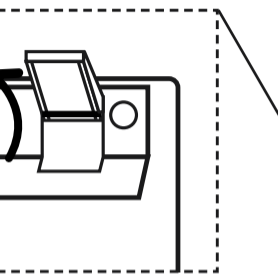
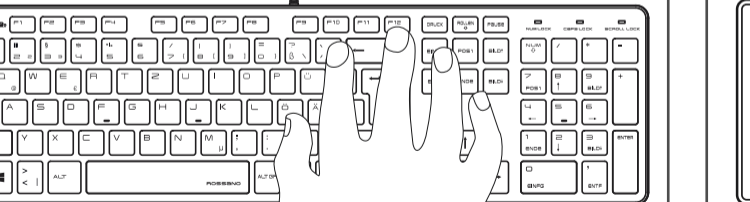

1

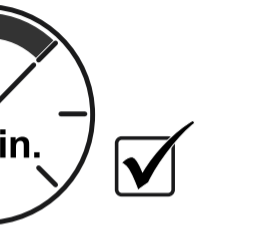

2

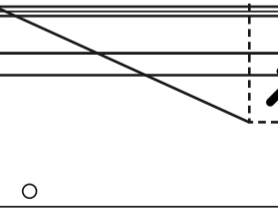
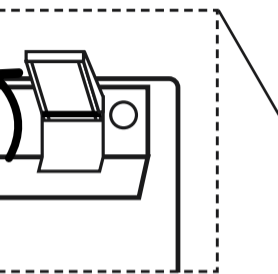
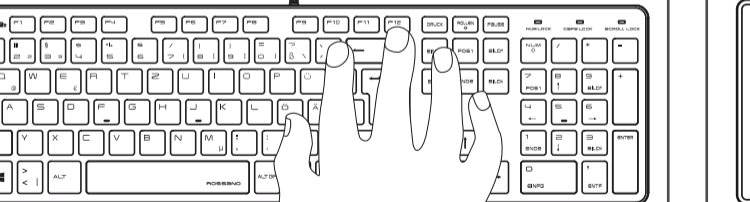

1

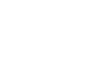
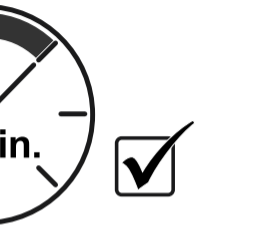

2

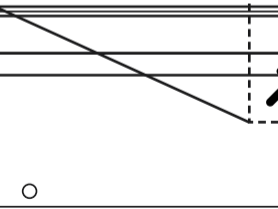
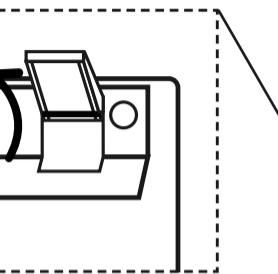
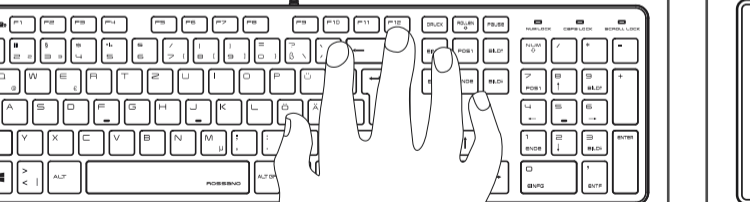

1

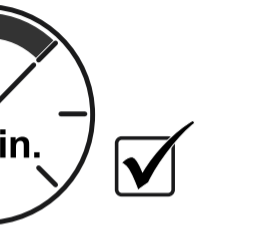

2

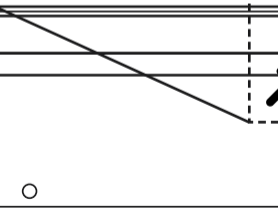
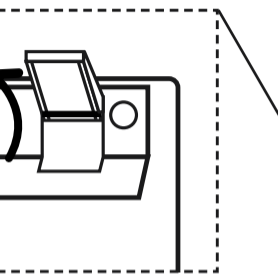
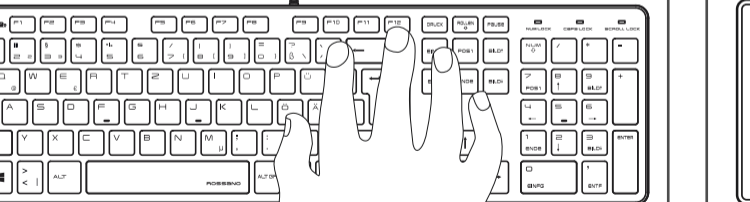

1

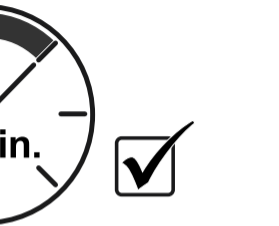

2

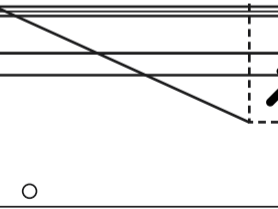
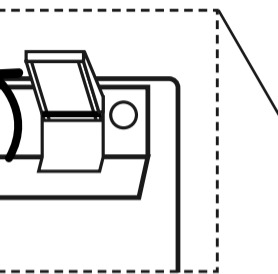
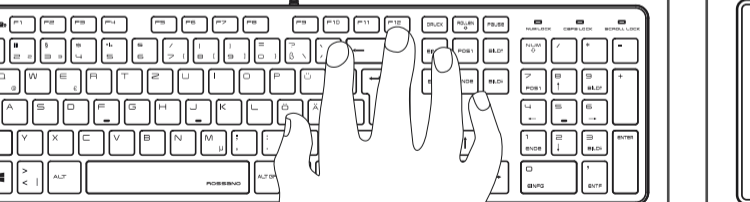

1

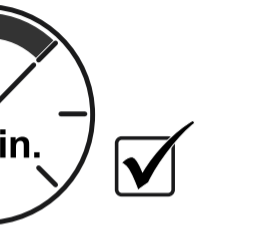

2

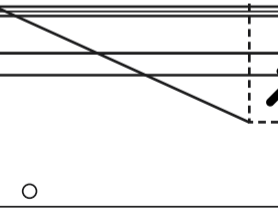
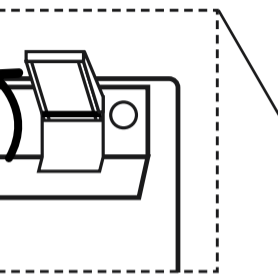
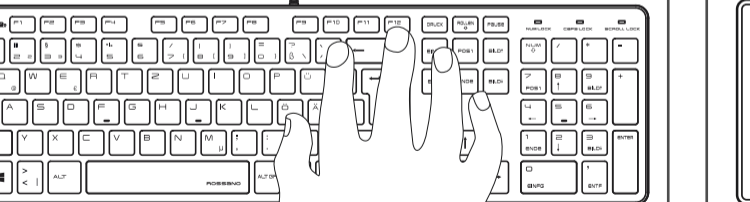

1

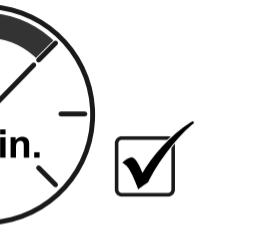

2

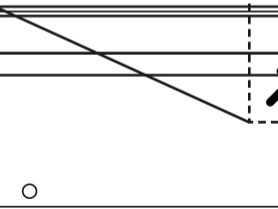
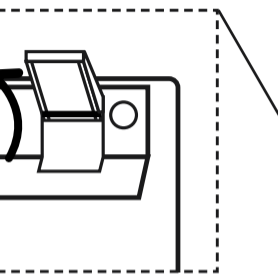
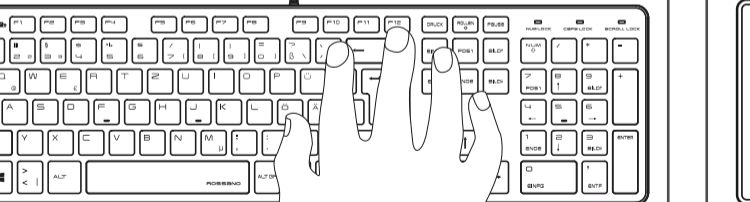

1

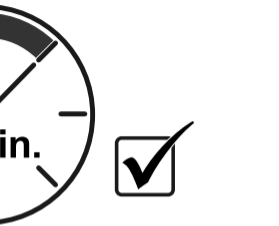

2

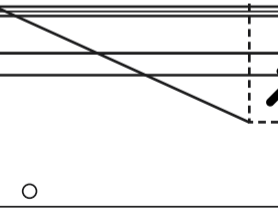
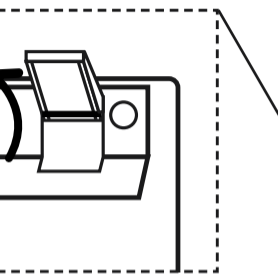
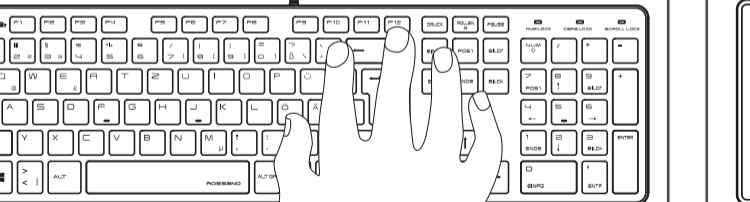

1

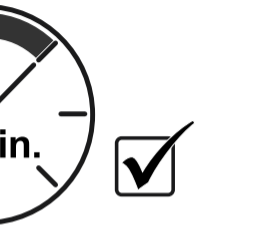

2

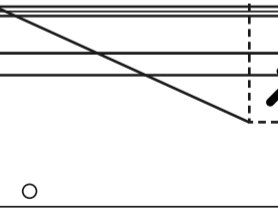
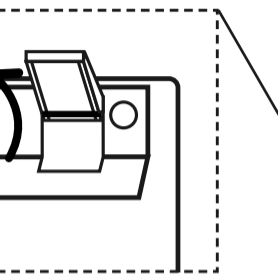
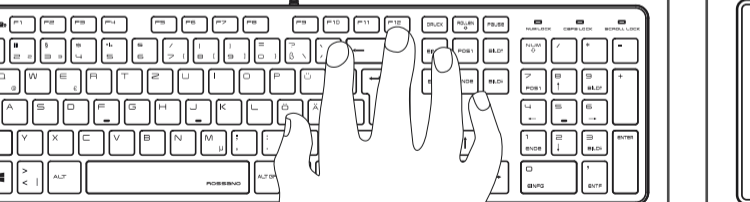

1

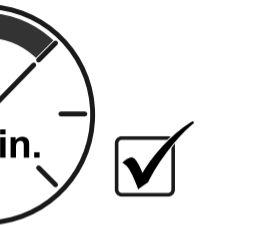

2

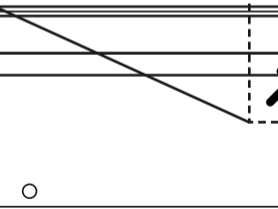
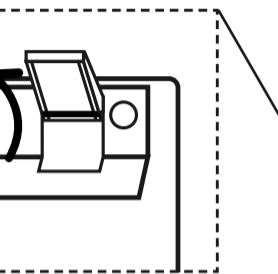
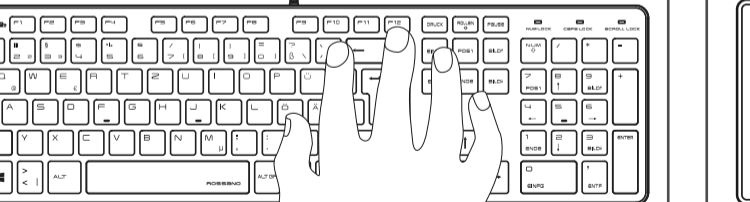

1

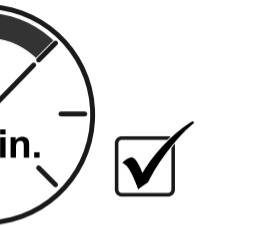

2

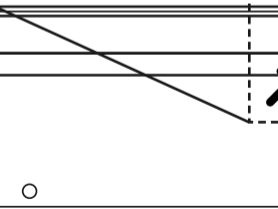
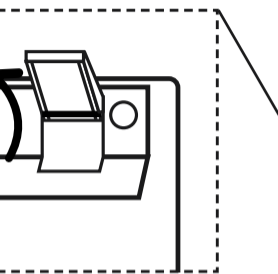
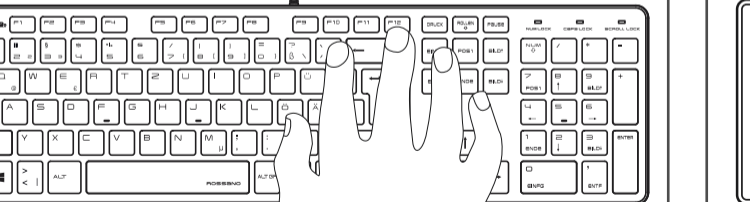

1

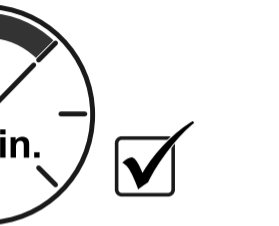

2

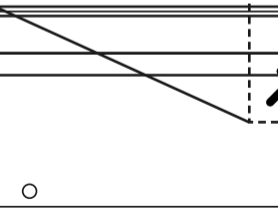
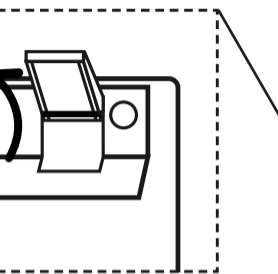
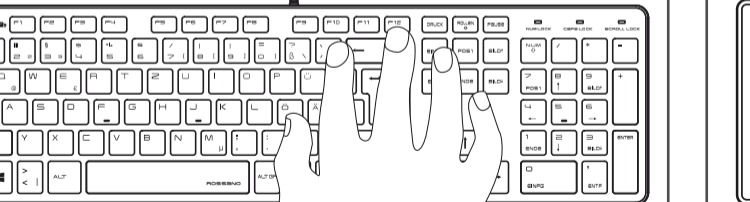

1

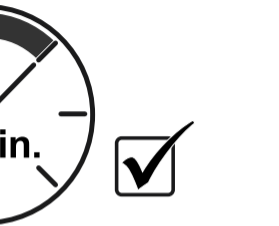

2

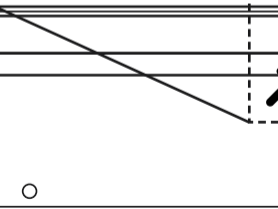
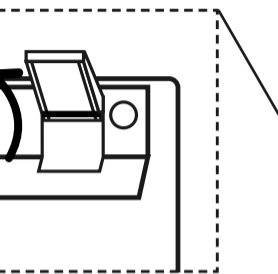
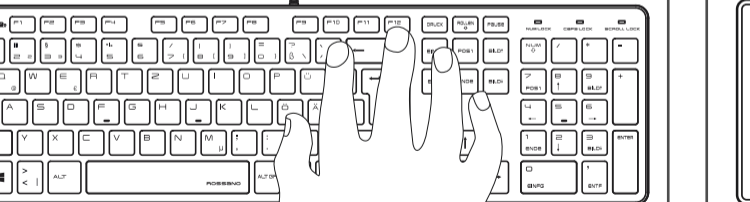

1

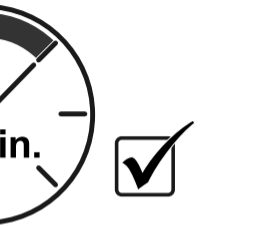

2

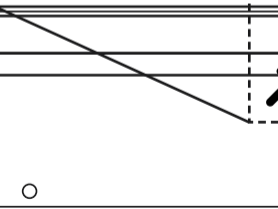
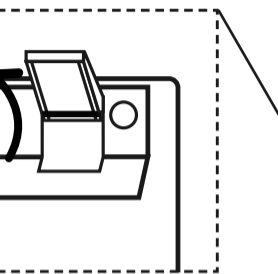
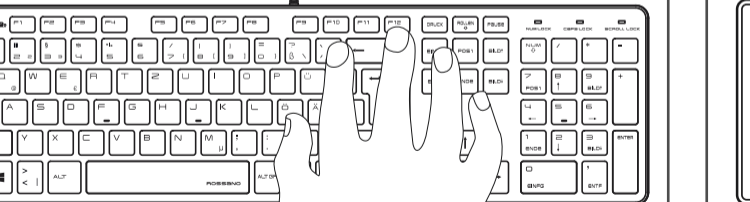

1

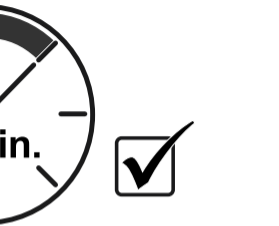

2

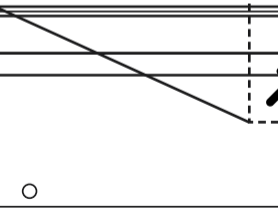
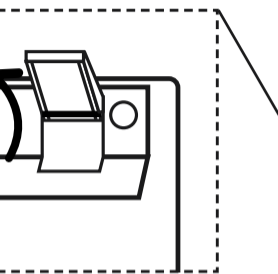
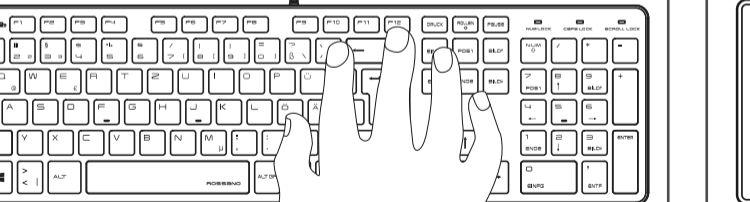

1

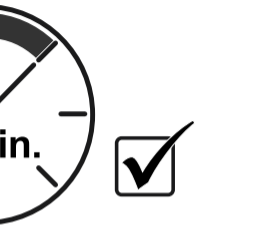

2

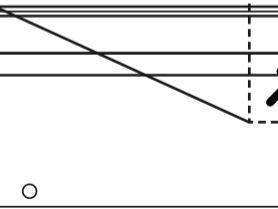
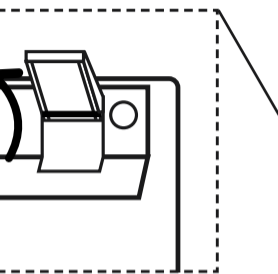
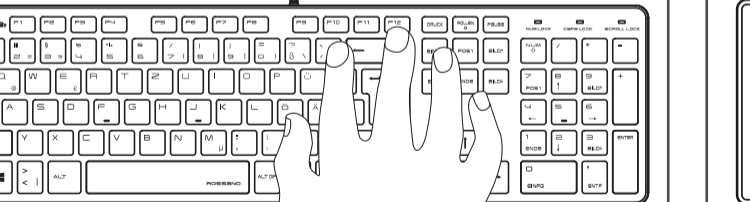

1

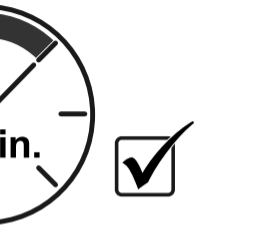

2

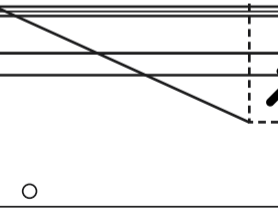
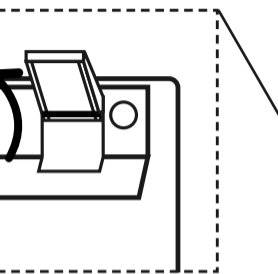
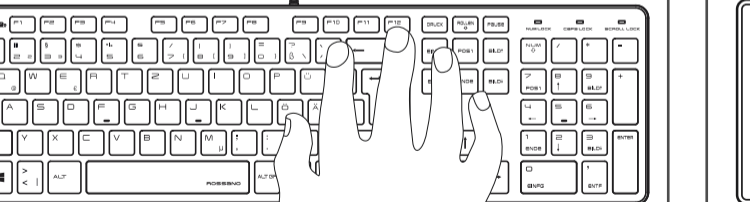

1

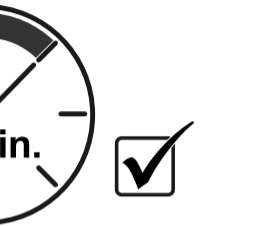

2

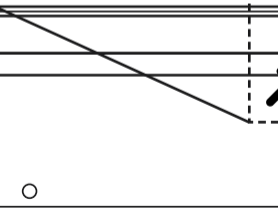
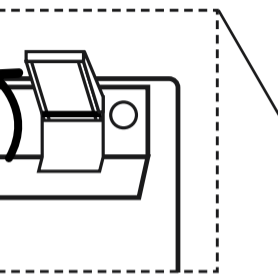
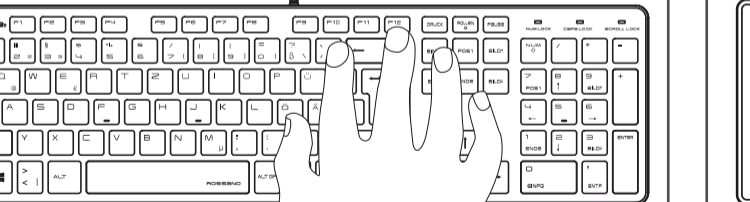

1

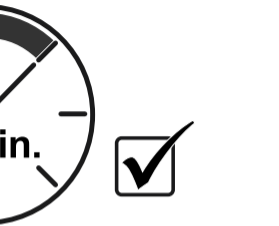

2

GB Note on environmental protection:

After the implementation of the European Directive 2002/96/EU and 2006/66/EU in the national legal system, the following applies:

Electric and electronic devices as well as batteries must not be disposed of with household waste. Consumers are obliged by law to return electrical and electronic devices as well as batteries at the end of their service lives to the public collecting points set up for this purpose or point of sale. Details to this are defined by the national law of the respective country. This symbol on the product, the instruction manual or the package indicates that a product is subject to these regulations. By recycling, reusing the materials or other forms of utilising old devices/Batteries, you are making an important contribution to protecting our environment.

D Hinweis zum Umweltschutz:

Ab dem Zeitpunkt der Umsetzung der europäischen Richtlinien 2002/96/EG und 2006/66/EG in nationales Recht gilt folgendes:

Elektrische und elektronische Geräte sowie Batterien dürfen nicht mit dem Hausmüll entsorgt werden. Der Verbraucher ist gesetzlich verpflichtet, elektrische und elektronische Geräte sowie Batterien am Ende ihrer Lebensdauer an den dafür eingerichteten, öffentlichen Sammelstellen oder an die Verkaufsstelle zurückzugeben. Einzelheiten dazu regelt das jeweilige Landesrecht. Das Symbol auf dem Produkt, der Gebrauchsanleitung oder der Verpackung weist auf diese Bestimmungen hin. Mit der Wiederverwertung, der stofflichen Verwertung oder anderen Formen der Verwertung von Altgeräten/Batterien leisten Sie einen wichtigen Beitrag zum Schutz unserer Umwelt.

F Remarques concernant la protection de l'environnement:

Conformément à la directive européenne 2002/96/CE et 2006/66/CE, et afin d'atteindre un certain nombre d'objectifs en matière de protection de l'environnement, les règles suivantes doivent être appliquées:

Les appareils électriques et électroniques ainsi que les batteries ne doivent pas être éliminés avec les déchets ménagers. Le pictogramme "picto" présent sur le produit, son manuel d'utilisation ou son emballage indique que le produit est soumis à cette réglementation. Le consommateur doit retourner le produit/la batterie usager aux points de collecte prévus à cet effet. Il peut aussi le remettre à un revendeur. En permettant enfin le recyclage des produits ainsi que les batteries, le consommateur contribuera à la protection de notre environnement. C'est un acte écologique.

E Nota sobre la protección medioambiental:

Después de la puesta en marcha de la directiva Europea 2002/96/EU y 2006/66/EU en el sistema legislativo nacional, se aplicara lo siguiente:

Los aparatos eléctricos y electrónicos, así como las baterías, no se deben evacuar en la basura doméstica. El usuario está legalmente obligado a llevar los aparatos eléctricos y electrónicos, así como pilas y pilas recargables, al final de su vida útil a los puntos de recogida comunales o a devolverlos al lugar donde los adquirió. Los detalles quedaran definidos por la ley de cada país. El símbolo en el producto, en las instrucciones de uso o en el embalaje hace referencia a ello. Gracias al reciclaje, al reciclaje del material o a otras formas de reciclaje de aparatos/pilas usados, contribuye Usted de forma importante a la protección de nuestro medio ambiente.

NL Notitie aangaande de bescherming van het milieu:

Ten gevolge van de invoering van de Europese Richtlijn 2002/96/EU en 2006/66/EU in het nationaal juridisch systeem, is het volgende van toepassing: Elektrische en elektronische apparatuur, zoals batterijen mag niet met het huisvuil weggegooid worden. Consumenten zijn wettelijk verplicht om elektrische en elektronische apparaten zoals batterijen op het einde van gebruik in te dienen bij openbare verzamelplaatsen speciaal opgezet voor dit doeleinde of bij een verkooppunt. Verdere specificaties aangaande dit onderwerp zijn omschreven door de nationale wet van het betreffende land. Dit symbool op het product, de gebruiksaanwijzing of de verpakking duidt erop dat het product onderworpen is aan deze richtlijnen. Door te recyclen, hergebruiken van materialen of andere vormen van hergebruiken van oude toestellen/batterijen, levert u een grote bijdrage aan de bescherming van het milieu.

I Informazioni per protezione ambientale:

Dopo l'implementazione della Direttiva Europea 2002/96/EU e 2006/66/EU nel sistema legale nazionale, ci sono le seguenti applicazioni:

Le apparecchiature elettriche ed elettroniche e le batterie non devono essere smaltite con i rifiuti domestici. I consumatori sono obbligati dalla legge a restituire i dispositivi elettrici ed elettronici e le batterie alla fine della loro vita utile ai punti di raccolta pubblici preposti per questo scopo o nei punti vendita. Dettagli di quanto riportato sono definiti dalle leggi nazionali di ogni stato. Questo simbolo sul prodotto, sul manuale d'istruzione o sull'imballo indicano che questo prodotto è soggetto a queste regole. Riciclando, ri-utilizzando i materiali o utilizzando sotto altra forma i vecchi prodotti/le batterie, darete un importante contributo alla protezione dell'ambiente.

GR Υπόδειξη σχετικά με την προστασία περιβάλλοντος:

Από τη στιγμή που η Ευρωπαϊκή Οδηγία 2002/96/ΕΕ και 2006/66/ΕΕ ενσωματώνεται στο εθνικό δίκαιο ισχύουν τα εξής: Οι ηλεκτρικές και οι ηλεκτρονικές συσκευές καθώς και οι μπαταρίες δεν επιτρέπεται να πετιούνται στα οικιακά απορρίμματα.

Οι καταναλωτές υποχρεούνται από τον νόμο να επιστρέφουν τις ηλεκτρικές και ηλεκτρονικές συσκευές καθώς και τις μπαταρίες στο τέλος της ζωής τους στα δημόσια σημεία περισυλλογής που έχουν δημιουργηθεί γι' αυτό το σκοπό ή στα σημεία πώλησης. Οι λεπτομέρειες ρυθμίζονται στη σχετική νομοθεσία. Το σύμβολο πάνω στο προϊόν, στο εγχειρίδιο χρήσης ή στη συσκευασία παραπέμπει σε αυτές τις διατάξεις. Με την ανακύκλωση, επαναχρησιμοποίηση των υλικών ή με άλλες μορφές χρησιμοποίησης παλιών συσκευών / Μπαταριών συνεισφέρετε σημαντικά στην προστασία του περιβάλλοντος. Στη Γερμανία ισχύουν αντίστοιχα οι παραπάνω κανόνες απόρριψης σύμφωνα με τον κανονισμό για μπαταρίες και συσσωρευτές.

S Not om miljöskydd:

Efter implementeringen av EU direktiv 2002/96/EU och 2006/66/EU i den nationella lagstiftningen, gäller följande: Elektriska och elektroniska apparater samt batterier får inte kastas i hushållssoporna. Konsumenter är skyldiga att återlämna elektriska och elektroniska apparater samt batterier vid slutet av dess livslängd till, för detta ändamål, offentliga uppsamlingsplatser. Detaljer för detta definieras via den nationella lagstiftningen i respektive land. Denna symbol på produkten, instruktionsmanualen eller på förpackningen indikerar att produkten innefattas av denna bestämmelse. Genom återvinning och återanvändning av material/batterier bidrar du till att skydda miljön och din omgivning.

FIN Ympäristönsuojelua koskeva ohje:

Siitä lähtien, kun Euroopan unionin direktiivi 2002/96/EU ja 2006/66/EU otetaan käyttöön kansallisessa lainsäädännössä, pätevät seuraavat määräykset:

Sähkö- ja elektroniikkalaitteita ja paristoja ei saa hävittää talousjätteen mukana. Kuluttajalla on lain mukaan velvollisuus toimittaa sähkö- ja elektroniikkalaitteet niiden käyttöäin päätyttyä niille varattuihin julkisiin keräyspisteisiin tai palauttaa ne myyntipaikkaan. Tähän liittyvistä yksityiskohdista säädetään kulloisenkin osavaltion laissa. Näistä määräyksistä mainitaan myös tuotteen symbolissa, käyttöohjeessa tai pakkauksessa. Uudelleenkäyttöllä, materiaalien/paristojen uudelleenkäyttöllä tai muilla vanhojen laitteiden uudelleenkäyttövoilla on tärkeä vaikutus yhteisen ympäristömme suojelussa.

PL Wskazówki dotyczące ochrony środowiska:

Od czasu wprowadzenia europejskiej dyrektywy 2002/96/EU i 2006/66/EU do prawa narodowego obowiązują następujące ustalenia:

Urządzeń elektrycznych, elektronicznych oraz baterii jednorazowych nie należy wyrzucać razem z codziennymi odpadami domowymi! Użytkownik zobowiązany prawnie do odniesienia zepsutych, zniszczonych lub niepotrzebnych urządzeń elektrycznych i elektronicznych do punktu zbiórki lub do sprzedawcy. Szczegółowe kwestie regulują przepisy prawne danego kraju. Informuje o tym symbol przekreślonego kosza umieszczony na opakowaniu. Segregując odpady pomagasz chronić środowisko!

H Környezetvédelmi tudnivalók:

Az európai irányelvek 2002/96/EU és 2006/66/EU ajánlása szerint, a megjelölt időponttól kezdve, minden EU-s tagállamban érvényesek a következők:

Az elektromos és elektronikai készülékeket és az elemeket nem szabad a háztartási szemétkébe dobni! A leselejtezett elektromos és elektronikus készülékeket és elemeket, akkumulátorokat nem szabad a háztartási szemétkébe dobni. Az elhasznált és működésképtelen elektromos és elektronikus készülékek gyűjtésére törvényi előírás kötelez mindenkit, ezért azokat el kell szállítani egy kijelölt gyűjtő helyre vagy visszavinni a vásárlás helyére. A termék csomagolásán feltüntetett szimbólum egyértelmű jelést ad erre vonatkozóan a felhasználónak. A régi készülékek begyűjtése, visszaváltása vagy bármilyen formában történő újra hasznosítása közös hozzájárulás környezetünk védelméhez.

CZ Ochrana životního prostředí:

Evropská směrnice 2002/96/EG a 2006/66/EU ustanovuje následující: Elektrická a elektronická zařízení stejně jako baterie nepatří do domovního odpadu. Spotřebitel se zavazuje odevzdat všechna zařízení a baterie po uplynutí jejich životnosti do příslušných sběrů. Podrobnosti stanoví zákon příslušné země. Symbol na produktu, návod k obsluze nebo balení na toto poukazuje. Recyklaci a jinými způsoby využití přispíváte k ochraně životního prostředí.

SK Ochrana životného prostredia:

Európska smernica 2002/96/EU a 2006/66/EU stanovuje: Elektrické a elektronické zariadenia, rovnako ako batérie sa nesmú vyhazovať do domáceho odpadu. Spotrebiteľ je zo zákona povinný zlikvidovať elektrické a elektronické zariadenia, rovnako ako batérie na miesta k tomu určené. Symbolizuje to obrázok v návode na použitie, alebo na balení výrobku. Opätovným využitíkovanim alebo inou formou recyklácie starých zariadení/batérií prispievate k ochrane životného prostredia.

P Nota em Protecção Ambiental:

Após a implementação da directiva comunitária 2002/96/EU e 2006/66/EU no sistema legal nacional, o seguinte aplica-se:

Os aparelhos eléctricos e electrónicos, bem como baterias, não podem ser eliminados juntamente com o lixo doméstico. Consumidores estão obrigados por lei a colocar os aparelhos eléctricos e electrónicos, bem como baterias, sem uso em locais públicos específicos para este efeito ou no ponto de venda. Os detalhes para este processo são definidos por lei pelos respectivos países. Este símbolo no produto, o manual de instruções ou a embalagem indicam que o produto está sujeito a estes regulamentos. Reciclando, reutilizando os materiais dos seus velhos aparelhos/ baterias, esta a fazer uma enorme contribuição para a protecção do ambiente.

RUS Охрана окружающей среды:

С момента перехода национального законодательства на европейские нормы 2002/96/EU и 2006/66/EU действительно следующее:

Электрические и электронные приборы, а также батареи запрещается утилизировать с обычным мусором. Потребитель, согласно закону, обязан утилизировать электрические и электронные приборы, а также батареи и аккумуляторы после их использования в специально предназначенных для этого пунктах сбора, либо в пунктах продажи. Детальная регламентация этих требований осуществляется соответствующим местным законодательством. Необходимость соблюдения данных предписаний обозначается особым значком на изделии, инструкции по эксплуатации или упаковке. При переработке, повторном использовании материалов или при другой форме утилизации бывших в употреблении приборов Вы помогаете охране окружающей среды. В соответствии с предписаниями по обращению с батареями, в Германии вышеназванные нормы действуют для утилизации батарей и аккумуляторов.

TR Çevre koruma uyarısı:

Avrupa Birliği Direktifi 2002/96/EU ve 2006/66/EU ulusal yasal uygulamalar için de geçerli olduğu tarihten itibaren: Elektrikli ve elektronik cihazlarla piller normal evsel çöpe atılmamalıdır. Tüketiciler için, artık çalışmayan elektrikli ve elektronik cihazları piller, kamuya ait toplama yerlerine götürme veya satın alindikları yerlere geri verme yasal bir zorunluluktur. Bu konu ile ilgili ayrıntılar ulusal yasalarla düzenlenmektedir. Ürün üzerinde, kullanma kılavuzunda veya ambalajda bulunan bu sembol tüketicileri bu konuda uyarır. Eski cihazların geri kazanımı, yapıldıkları malzemelerin değerlendirilmesi veya diğer değerlendirme şekilleri ile, çevre korumasına önemli bir katkıda bulunursunuz. Yurtarada adı geçen atık toplama kurulları Almanya'da piller ve aküler için de geçerlidir.

RO Instrucțiuni pentru protecția mediului inconjurător:

Din momentul aplicării directivelor europene 2002/96/UE în dreptul național sunt valabile următoarele: Aparatele electrice și electronice nu pot fi salubizate cu gunoii menajer. Consumatorul este obligat conform legii să predea aparatele electrice și electronice la sfârșitul duratei de utilizare la locurile de colectare publice sau înapoi de unde au fost cumpărate.

Detaliile sunt reglementate de către legislația țării respective. Simbolul de pe produs, în instrucțiunile de utilizare sau pe ambalaj indică aceste reglementări. Prin reciclarea, revalorificarea materialelor sau alte forme de valorificare a aparatelor scoase din uz aduceți o contribuție importantă la protecția mediului nostru inconjurător.

DK Anvisninger til beskyttelse af miljøet:

Fra og med indførelsen af EU-direktiverne 2002/96/EF og 2006/66/EF i national ret gælder følgende: Elektrisk og elektronisk udstyr samt batterier må ikke bortskaffes sammen med almindeligt husholdningsaffald.

Forbrugeren er lovmæssigt forpligtet til at aflevere udtjent elektrisk og elektronisk udstyr samt batterier til dertil indrettede, offentlige indsamlingssteder eller til forhandleren. De nærmere bestemmelser vedr. dette fastlægges af lovgivningen i det pågældende land. Symbolet på produktet, brugsvejledningen eller emballagen henviser til disse bestemmelser. Ved genbrug, genvinding eller andre former for nyttiggørelse af udtjent udstyr/batterier giver du et vigtigt bidrag til beskyttelse af miljøet.

N Informasjon om beskyttelse av miljøet:

Fra tidspunktet for omsetning av de europeiske direktivene 2002/96/EF og 2006/66/EF i nasjonal rett gjelder følgende: Elektriske og elektroniske apparater og batterier må ikke deponeres sammen med husholdningssoppelet. Forbrukeren er lovmessig forpliktet til å levere elektriske og elektroniske apparater og batterier til de offentlige samlestedene eller tilbake til stedet hvor produktene ble kjøpt. Detaljer angående dette reguleres av hvert land. Symbolet på produktet, bruksanvisningen eller emballasjen henviser om disse bestemmelsene. Med resirkulering, gjenbruk av stoffer eller andre former av gjenbruk av gamle apparater/batterier bidrar du betydelig til å beskytte miljøet vårt.

SRB Napomene o ekološkoj zaštiti:

Od trenutka primene evropskih Direktiva 2002/96/EZ i 2006/66/EZ u nacionalnom pravu: Električni i elektronski uređaji, kao ni baterije ne smeju da se odlažu u kućni otpad. Potrošač je zakonski obavezan da električne i elektronske uređaje i baterije na kraju njihovog životnog veka preda javnim preduzećima za sabiranje otpada ili prodajnom mestu. Pojednosto reguliše dotično nacionalno pravo. Simbol na proizvodu, uputstvu za upotrebu ili ambalaži ukazuje na te odredbe. Reciklažom, ponovnim iskorišćenjem materijala ili drugim oblicima iskorišćenja starih uređaja/baterija u velikoj meri doprinosite očuvanju naše životne okoline.

LT Nuoroda dėl aplinkos apsaugos:

Nuo to laiko, kai Europos direktyvos 2002/96/EB ir 2006/66/EB buvo perkeltos į nacionalinę teisę, galioja toliau nurodytos taisyklės:

elektrinių, elektroninių prietaisų ir akumuliatorių baterijų negalima išmesti kartu su buitiniems atliekomis. Naudotojas pagal įstatymų įsipareigoja elektrinius, elektroninius prietaisus ir akumuliatorių baterijas, kurių naudojimo trukmė pasibaigė, nugabinti ir specialiai tam įrengtą viešąją surinkimo arba pardavimo vietą. Šias taisykles išsamiai reglamentuoja atitinkamos šalies teisė. Ant gaminio, pakuočių arba naudojimo instrukcijų pateiktas simbolis nurodo, jog būtina laikytis šios nuostatos. Senus prietaisus / akumuliatorių baterijas atiduodami perdirbti, pakartotinai naudoti arba utilizuodami kitu būdu prisidedate prie mūsų aplinkos apsaugos.

BG Указание относно защитата на околната среда:

От момента на прилагането на европейските директиви 2002/96/EO и 2006/66/EO в националното право на съответните страни важи следното:

Електрическите и електронните уреди и батериите не бива да се изхвърлят с битовите отпадъци. Потребителят е длъжен по закон да върне електрическите и електронните уреди и батериите в края на тяхната дълготрайност на изградения за целта обществени сборни пунктове или на търговския обект. Подробностите по въпроса са регламентирани в законодателството на съответната страна. Символът върху продукта, упътването за употреба или опаковката насочва към тези разпоредби. Чрез рециклирането, преработката на материалите или други форми на оползотворяване на старите уреди/батерии вие допринасяте за защитата на нашата околна среда.

UA Указівки щодо охорони навколишнього середовища:

З моменту впровадження європейських Директив 2002/96/ЄС і 2006/66/ЄС у національну законодавчу систему діють наступні правила:

Електричні й електронні пристрої, наприклад акумулятори, заборонено утилізувати разом із побутовими відходами. Після закінчення терміну служби електричних й електронних пристроїв, наприклад акумуляторів, користувач на законодавчому рівні зобов'язаний здати їх у спеціально передбачений пункт збору або в точку продажу. Детальні умови здавання цих пристроїв визначаються відповідно до національного законодавства. На ці умови вказує символ, розміщений на виробі, у посібнику з експлуатації або на упаковці. Завдяки вторинному використанню, належній утилізації або іншим способам використання старих пристроїв або акумуляторів ви робите суттєвий внесок в охорону навколишнього середовища.