

Mod. G7520 - Fittings Series 7000 - Automation

Product code: G7520 12-1/4

Datasheet creation date: 12/12/2025 08:33

Check the most updated document online [click here](#)



TECHNICAL DATA

Mod.	G7520 12-1/4
------	--------------

Mod. G7520 - Fittings Series 7000 - Automation

Product code: G7520 12-1/4

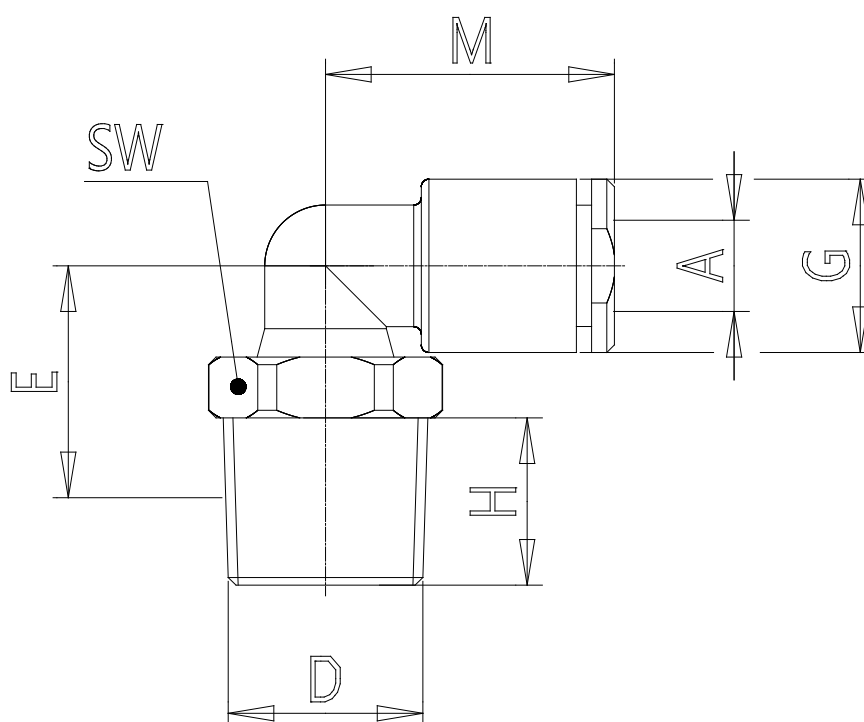

DIMENSIONS

A (mm)	12
D	R1/4
E (mm)	18.5
G (mm)	20.0
H (mm)	11.0
M (mm)	31.0
SW (mm)	16
Weight (g)	23.0