

Plug PowerTOP® - Part no. 3926

- screw terminals
- highly heat resistant contact carrier
- nickel plated contacts
- cable gland and external cable grip

Protection type	IP 44
Ampere	16 A
Poles	4 p
Voltage	400 V
Hertz	50-60 Hz
Earth position	6 h
Contact	nickel plated contacts, highly heat resistant contact carrier
Connection technology	Screw terminals

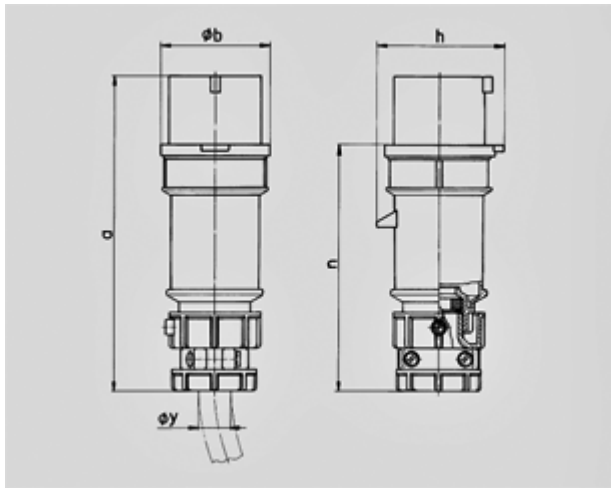

Drawing	Amp.	16			32		
		3	4	5	3	4	5
2 MB 174	Poles						
Dim. in mm	a	162	172	186	199	199	213
	b	54	60	69	72	72	79
	h	60	67	77	83	83	91
	n	126	136	149	154	154	169
	y	19	19	22	24,5	24,5	28,5
Terminal for cond. cross		1	1	1	2,5	2,5	2,5
section (mm ²) min.-max.		-2,5	-2,5	-2,5	-6	-6	-6