

DESCRIPTION

The EVAL-ADXL327Z is a simple evaluation board that allows quick evaluation of the performance of the ADXL327 three-axis accelerometer. The EVAL-ADXL327Z has a 6-pin, 0.1 inch spaced header for access to all power and signal lines that the user can attach to a prototyping board (breadboard) or wire using a standard plug. Four holes are provided for mechanical attachment of the EVAL-ADXL327Z to the ADXL327.

The dimensions of the EVAL-ADXL327Z are 20 mm × 20 mm with mounting holes set 15 mm × 15 mm at the corners of the printed circuit board (PCB).

CIRCUIT DESCRIPTION

The schematic of the EVAL-ADXL327Z is shown in Figure 1. Analog bandwidth can be set by changing the C2, C3, and C4 capacitors. See the ADXL327 data sheet for a complete description of the operation of the accelerometer.

The part layout of the EVAL-ADXL327Z is shown in Figure 2. The EVAL-ADXL327Z has four factory installed 100 nF capacitors. C1 at V_S is a bypass capacitor to reduce supply noise. C2, C3, and C4 at X_{OUT}, Y_{OUT}, and Z_{OUT} are filter capacitors to set the bandwidth to 50 Hz (see Figure 1). Many applications require a different bandwidth, in which case the user can change C2, C3, and C4 as appropriate.

SPECIAL NOTES ON HANDLING

The EVAL-ADXL327Z is not reverse polarity protected. Reversing the +V supply and ground pins can cause damage to the ADXL327.

Dropping the EVAL-ADXL327Z on a hard surface can generate acceleration greater than 1000 g, which may exceed the data sheet absolute maximum limits. See the [ADXL327](#) data sheet for more information.

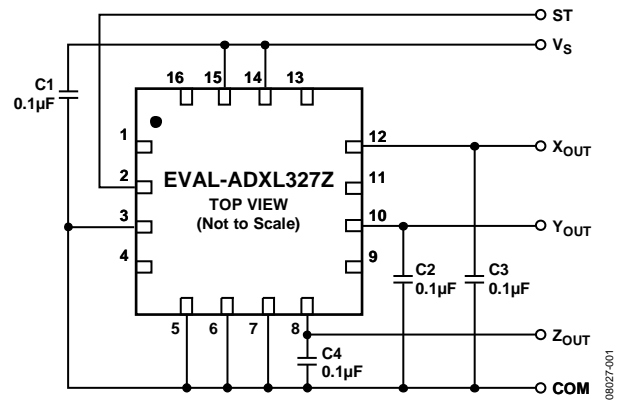

Figure 1. Schematic

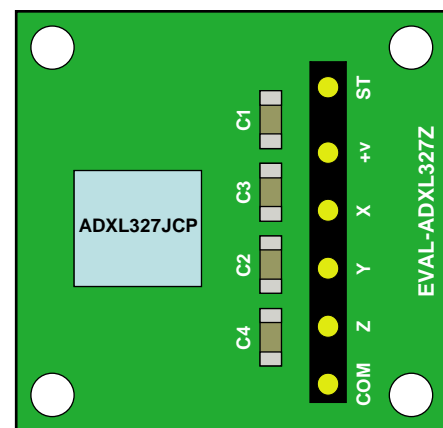

Figure 2. Physical Layout

Rev. PrA

Evaluation boards are only intended for device evaluation and not for production purposes. Evaluation boards are supplied "as is" and without warranties of any kind, express, implied, or statutory including, but not limited to, any implied warranty of merchantability or fitness for a particular purpose. No license is granted by implication or otherwise under any patents or other intellectual property by application or use of evaluation boards. Information furnished by Analog Devices is believed to be accurate and reliable. However, no responsibility is assumed by Analog Devices for its use, nor for any infringements of patents or other rights of third parties that may result from its use. Analog Devices reserves the right to change devices or specifications at any time without notice. Trademarks and registered trademarks are the property of their respective owners. Evaluation boards are not authorized to be used in life support devices or systems.

NOTES