Ultrasonic sensors

XX range

Catalogue



Simply easy!™

Optimise detection with XX range

Detect objects in challenging applications with our XX ultrasonic sensors range. These ultrasonic sensors offer an efficient solution for reliable and high performance detection at distances of up to 8 m, on window mode*.

* The window mode enables suppression of the foreground and the background using the same sensor.

> A technology suited to your needs

Detect objects regardless lighting conditions or material reflectivity degree.

> 3 operating modes for efficient detection

Ideal for detecting irregular-shaped objects.

> Short or long distance detection

From 50 mm up to 8 m.

Contents

Selection guide based on applications	pages 4 and 5
Product selection guide	pages 6 to 9
Application examples	pages 10 to 15
General	pages 16 to 21
Cylindrical sensors	pages 22 to 41
Cylindrical sensors, configurable by software	pages 42 to 61
Obstacle detection system for mobile equipment	pages 62 to 67
Flat format sensors	pages 68 to 71
XX configuration software	pages 74 to 77
Accessories	pages 78 and 79
Product reference index	page 80

> A technology suited to your needs

Ultrasonic sensors enable non-contact detection of objects in many kinds of industrial environment, irrespective of :

- material (metal, plastic, wood, cardboard, etc.),
- nature (solid, liquid, powder, paste, etc.),
- colour,
- degree of transparency.

The ultrasonic sensors are simple to install; they feature integrated connectors, or cable versions in select models, and offer a wide range of cabling and mounting accessories for a seamless integration.

> 3 operating modes for efficient detection

Diffuse mode

An object reflects the ultrasonic wave back to the sensor which, in turn, changes the output state.

This operating mode is well suited for detecting objects with flat surfaces that are positioned perpendicularly to the direction of the ultrasonic beam.

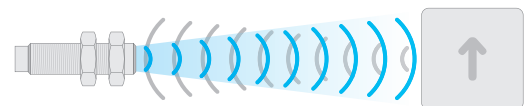

Reflex mode

The sensor is permanently detecting a fixed background (previously taught) on a machine or application. When another object breaks the ultrasonic beam, the output changes its state.

Well suited for detecting objects that absorb the ultrasonic waves (sponges, etc.) or that do not reflect the wave back to the sensor (non-flat surfaces, pointy or irregular-shaped objects).

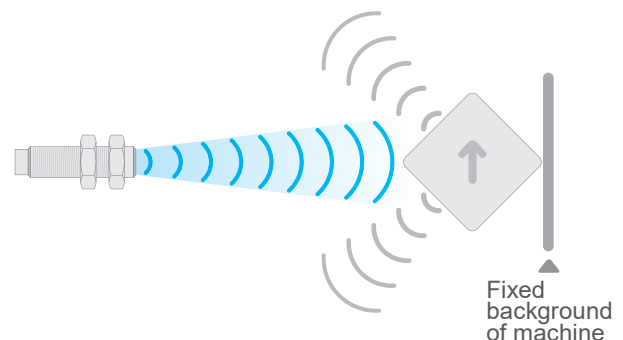

Thru-beam mode

The transmitter is constantly sending an ultrasonic wave to the receiver. When an object breaks the ultrasonic beam, the output changes its state.

Well suited for small object detection and applications where higher accuracy and faster response time are required.

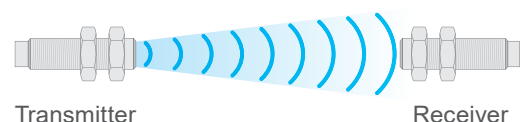

> Long distance proximity detection

Ultrasonic technology allows now for long distance proximity detection. The XXV Ø18 ultrasonic sensors enable detection from 0 to 50 mm (i.e. 2.5 times farther than standard inductive proximity sensors) with minimal environment constraints or object material and colour restrictions.

Sensors mounted too close to moving-metal parts are exposed to hits or impacts which can cause machine downtime. Being able to install sensors farther away from moving targets reduces the exposure to potential incidents. You increase installation profitability!

x 2.5
detection distance
than standard
inductive proximity
sensors

XXV Ø 18 sensor

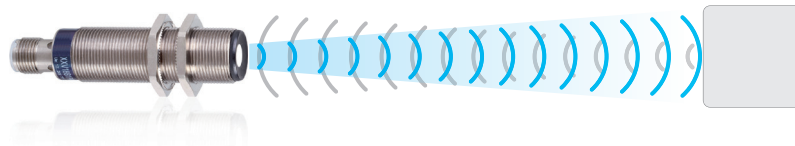

Standard inductive proximity sensor

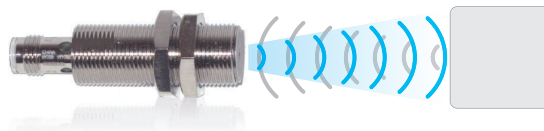

The XXV ultrasonic sensor is a “Plug and Play” solution with no adjustment or teaching required. Its solid-state output changes state when an object is less than 50 mm away from the sensor face.

Its accurate and well-defined transmission angle enables precise detection. Crosstalk with other sensors and object edge effects are mastered.

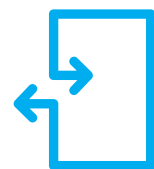

Plug & Play solution



100 %
Worldwide availability

Sensor type	Detection "Digital"							Regulation "Analogue output"					Level monitoring		Mobile equipment
-------------	---------------------	--	--	--	--	--	--	------------------------------	--	--	--	--	------------------	--	------------------

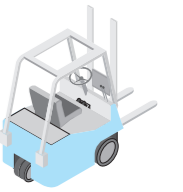
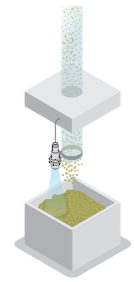
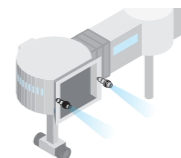
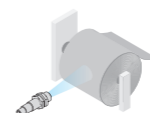
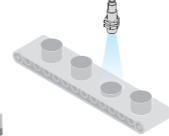
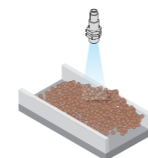
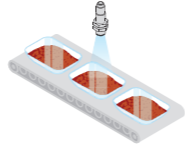
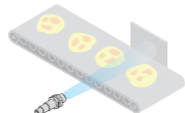
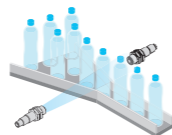
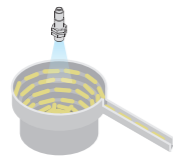

Assembly		Conveying			Packaging	
Machine part	Vibrating bowl	Presence Absence	Transparent bottles	Jam	Flow	Transparent film

Conveying		Packaging	Handling		Process		Handling
Material level	Height of part	Radius of strip roll	Height of elevating table	Aircraft boarding bridge	Monitoring 2 thresholds	Filling Emptying	Forklift

Ø 18 (M18x1)	Reflex mode		Thru-beam mode				
Ø 12 (M12x1)	Reflex mode		Thru-beam mode				
Ø 18 (M18x1)	Reflex mode		Thru-beam mode		Reflex mode		
Ø 30 (M30x1.5)	Reflex mode		Thru-beam mode		Reflex mode		
79x32.5+Ø 54	Reflex mode		Thru-beam mode		Reflex mode		
7.6x19x33	Reflex mode		Thru-beam mode		Reflex mode		
16x30x74	Reflex mode		Thru-beam mode		Reflex mode		
18x33x60 Ø 18 (M18x1)	Reflex mode		Thru-beam mode		Reflex mode		
80x80x34	Reflex mode		Thru-beam mode		Reflex mode		

Diffuse mode		Diffuse mode		Diffuse mode		Diffuse mode		Diffuse mode
Diffuse mode		Diffuse mode		Diffuse mode		Diffuse mode		Diffuse mode
Diffuse mode		Diffuse mode		Diffuse mode		Diffuse mode		Diffuse mode
Diffuse mode		Diffuse mode		Diffuse mode		Diffuse mode		Diffuse mode
Diffuse mode		Diffuse mode		Diffuse mode		Diffuse mode		Diffuse mode
Diffuse mode		Diffuse mode		Diffuse mode		Diffuse mode		Diffuse mode
Diffuse mode		Diffuse mode		Diffuse mode		Diffuse mode		Diffuse mode
Diffuse mode		Diffuse mode		Diffuse mode		Diffuse mode		Diffuse mode
Diffuse mode		Diffuse mode		Diffuse mode		Diffuse mode		Diffuse mode

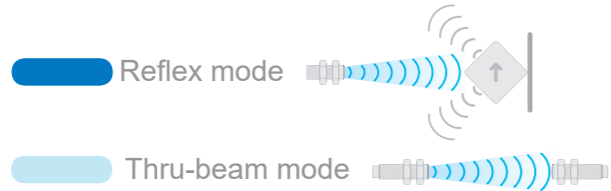

Ultrasonic sensors

XX range

Cylindrical type

Applications
Non-contact detection of sound reflecting objects regardless their shape, material, colour, orientation, etc.

Dimensions (mm)

Sensors with solid-state digital output

Cylindrical type

Ø 12 (M12 x 1)



Ø 18 (M18 x 1)



Ø 18 (M18 x 1) (continued)



Ø 30 (M30 x 1.5)

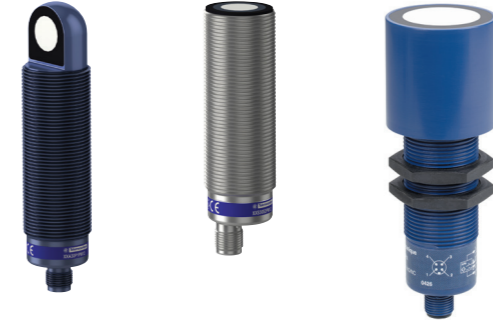

Cylindrical type

Application, monitoring 2 levels

Ø 18 (M18 x 1)

Ø 30 (M30 x 1.5)



Sensing distance Sn	Diffuse					
	Reflex					
	Thru-beam			20 cm		
Assured operating distance (mm)	6.4...51 fixed	6.4...102 fixed	–	2...50 fixed	25...152 fixed	Adjustable using teach mode
Power supply	12...24 V $\overline{\text{---}}$ with protection against reverse polarity					
Type of output	PNP/NPN	NPN or PNP	PNP/NPN	PNP or NPN	PNP/NPN	NPN or PNP
Function	NO	NO	NO/NC	NO/NC	NO	NO
Degree of protection	IP 67	IP 67	IP 67	IP 67	IP 67	IP 67
Connection	M8 connector	M8 connector	M8 connector	M12 connector or pre-cabled	M12 connector	M12 connector or pre-cabled
Sensor type	XX512A1●	XX512A2●	XX●12A8●	XXV18B1●	XX518A1●	XX518A3●
Page	22			22	26	

5 cm	10 cm	–	5 cm	15 cm	50 cm
–	–	–	–	–	50 cm
–	–	20 cm	–	–	–
6.4...51 fixed	6.4...102 fixed	–	2...50 fixed	25...152 fixed	Adjustable using teach mode
12...24 V $\overline{\text{---}}$ with protection against reverse polarity					
PNP/NPN	NPN or PNP	PNP/NPN	PNP or NPN	PNP/NPN	NPN or PNP
NO	NO	NO/NC	NO/NC	NO	NO
IP 67	IP 67	IP 67	IP 67	IP 67	IP 67
M8 connector	M8 connector	M8 connector	M12 connector or pre-cabled	M12 connector	M12 connector or pre-cabled
XX512A1●	XX512A2●	XX●12A8●	XXV18B1●	XX518A1●	XX518A3●
22			22	26	

–	1 m	1 m	2 m/4 m depending on model	8 m	50 cm	1 m/2 m depending on model	8 m
–	1 m	1 m	2 m/4 m depending on model	8 m depending on model	–	–	–
61 cm/1 m	–	–	–	–	–	–	–
–	Adjustable using teach mode	Adjustable using teach mode			Adjustable using teach mode		
12...24 V $\overline{\text{---}}$ with protection against reverse polarity						12...24 V $\overline{\text{---}}$ with protection against reverse polarity	
PNP/NPN	PNP	PNP or NPN or PNP/NPN		PNP or NPN	PNP or NPN	PNP/NPN	PNP
NO/NC	NO or NC (selectable)	NO or NC or NO+NC or NO+NO		NO + NC NO or NC (selectable)	NO	NO + NO	NO + NO
IP 67	IP 67	IP 67	IP 67	IP 67	IP 67	IP 67	IP 67
M12 connector	M12 connector	M12 connector	M12 connector	M12 connector	M12 connector	M12 connector	M12 connector
XX●18A3● XX●18A4●	XX●18●1PM12	XX●30●●1PM12 XX6V3A1● XX630A1●	XX●30●●2PM12 XXS30●●4PM12 XX630A2●	XX630A3● XXS30P8PPM12 XXS30P8NNM12	XX218A3●	XX230A1● XX230A2●	XX230A3●
26	30	36 and 42			40		(1)

Sensors with analogue output

Cylindrical type

Ø 18 (M12 x 1)



Ø 18 (M12 x 1) (continued)



Ø 30 (M30 x 1.5)

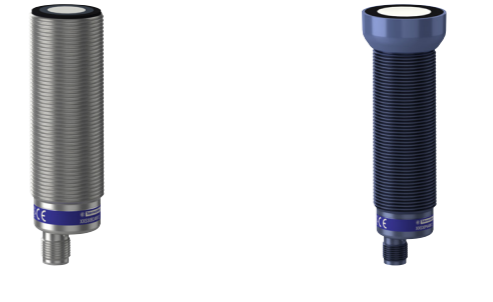

Sensing distance Sn	50 cm	1 m
Assured operating distance (mm)	Adjustable using teach mode	Adjustable using teach mode
Power supply	12...24 V $\overline{\text{---}}$ with protection against reverse polarity	
Type of output	4-20 mA or 0-10 V	4-20 mA or 0-10 V
Degree of protection	IP 67	IP 67
Connection	M12 connector	M12 connector
Sensor type	XX918A3●	XX●18●1AM12 XX●18●1VM12
Page	26	30

50 cm	1 m
Adjustable using teach mode	Adjustable using teach mode
12...24 V $\overline{\text{---}}$ with protection against reverse polarity	
4-20 mA or 0-10 V	4-20 mA or 0-10 V
IP 67	IP 67
M12 connector	M12 connector
XX918A3●	XX●18●1AM12 XX●18●1VM12
26	30

1 m	2 m	4 m	8 m
Adjustable using teach mode			
12...24 V $\overline{\text{---}}$ or 24 V $\overline{\text{---}}$, depending on model, with protection against reverse polarity			
4-20 mA or 0-10 V			
4-20 mA or 0-10 V		4-20 mA or 0-10 V PNP, NO or NC (selectable)	
IP 67	IP 67	IP 67	IP 67
M12 connector	M12 connector	M12 connector	M12 connector
XX●30●1●M12 XX9V3A1● XX930A1●	XX●30●2●M12 XX930A2●	XXS30●4●M12	XX930A3● XXS30P8APM12 XXS30P8VPM12
36	42	42	36 and 42

(1) Please visit our website: www.telesensors.com

Ultrasonic sensors

XX range
Flat format

Applications
Non-contact detection of sound reflecting objects regardless their shape, material, colour, orientation, etc.

Dimensions (mm)

Sensors with solid-state digital output

Flat format

7.6 x 19 x 33

16 x 30 x 74



18 x 33 x 60 + Ø 18 (M18 x 1)

80 x 80 x 34



Sensing distance Sn	Diffuse
	Reflex
	Thru-beam
Assured operating distance (mm)	6.4...100 fixed
Power supply	12...24 V $\overline{\text{DC}}$ with protection against reverse polarity
Type of output	NPN or PNP
Function	NO
Degree of protection	IP 67
Connection	M12 connector on flying lead
Sensor type	XX7F1A2
Page	68

10 cm	25 cm
-	-
-	-
6.4...100 fixed	51...250 fixed
12...24 V $\overline{\text{DC}}$ with protection against reverse polarity	
NPN or PNP	PNP
NO	NO
IP 67	IP 67
M12 connector on flying lead	M12 connector
XX7F1A2	XX7K1A2PAM12
68	68

50 cm (adjustable)	1 m (adjustable)
50 cm (adjustable)	1 m (adjustable)
-	-
Adjustable using teach mode	
12...24 V $\overline{\text{DC}}$ with protection against reverse polarity	
NPN or PNP	NPN or PNP
NO	NO
IP 67	IP 67
M12 connector	M12 connector
XX7V1A1	XX8D1A1
68	68

Dimensions (mm)

Sensors with solid-state digital output and analogue output

Format for mobile equipments

79 x 32.5 + Ø 54



Sensing distance Sn	3 m
Assured operating distance (mm)	0.425...3
Power supply	$\overline{\text{DC}}$ 12...24 V with protection against reverse polarity
Type of output	0.5 - 4.5 V + PNP or 4-20 mA + PNP (depending on model)
Degree of protection	IP 65, IP 67, IP 69K
Connection	Deutsch DTM04 connector on flying lead (0.15 m) Pre-cabled (0.5 m)
Sensor type	XXW54P3
Page	63

Sensors with analogue output

Flat format

18 x 33 x 65 + Ø 18 (M18 x 1)

80 x 80 x 34



50 cm (adjustable)	1 m (adjustable)
Adjustable using teach mode	
12...24 V $\overline{\text{DC}}$ with protection against reverse polarity	24 V $\overline{\text{DC}}$ with protection against reverse polarity
4-20 mA	0-10 V
IP 67	IP 67
M12 connector	M12 connector
XX9V1A1C2M12	XX9V1A1F1M12
69	69

Feeder bowl supply control

XXS18, XXA18, XX7V1A1

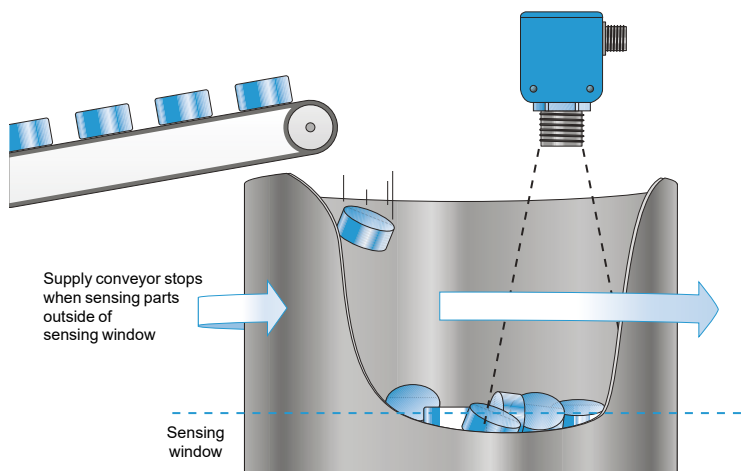

Conveyor jam and backup detection

XXS18, XXA18, XXB18A3

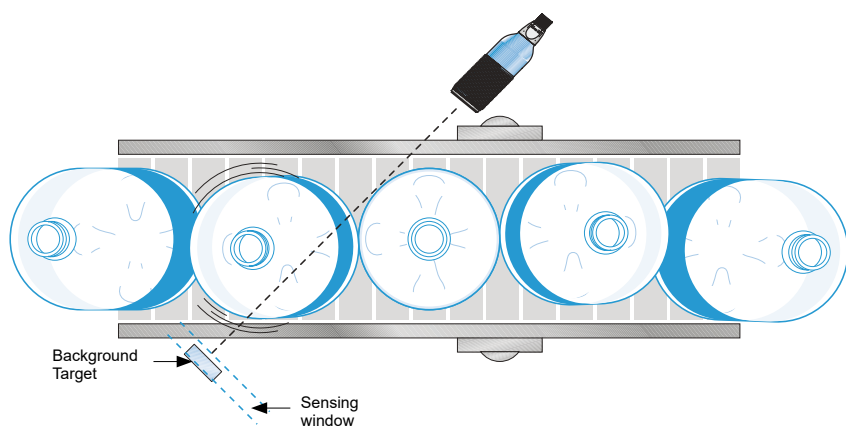

Web process control sensing functions

XXS18, XXS30

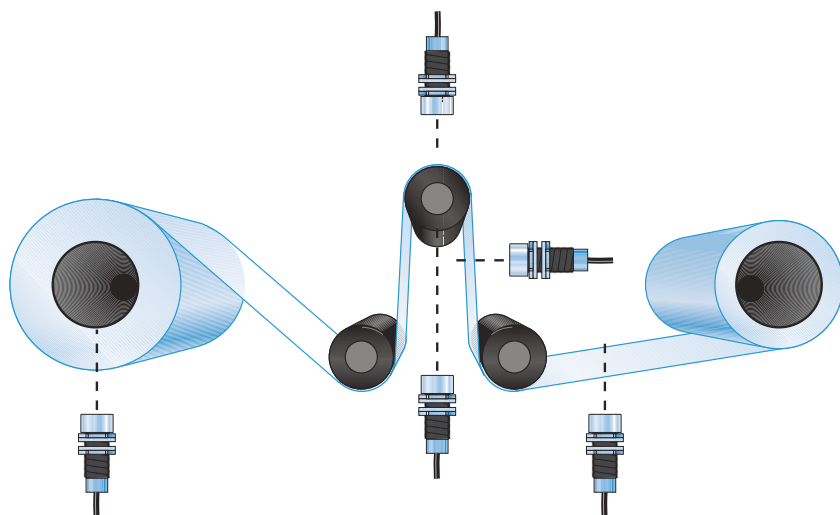

Dual level high-low latch control detection of liquids

XXS30P8, XX230A3

High level detection

XXS30P8, XX630A3

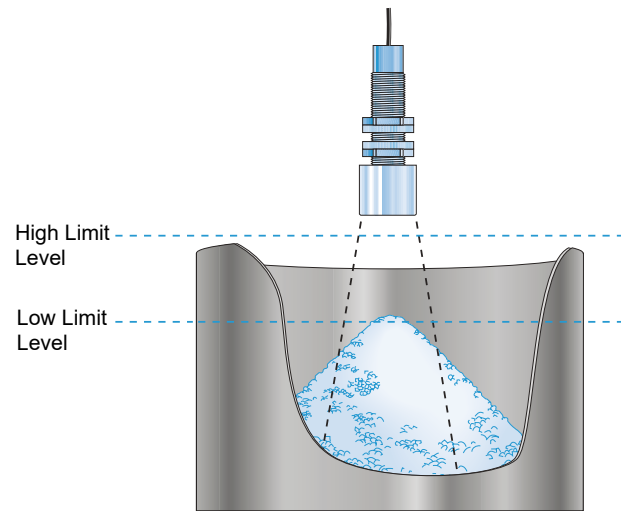
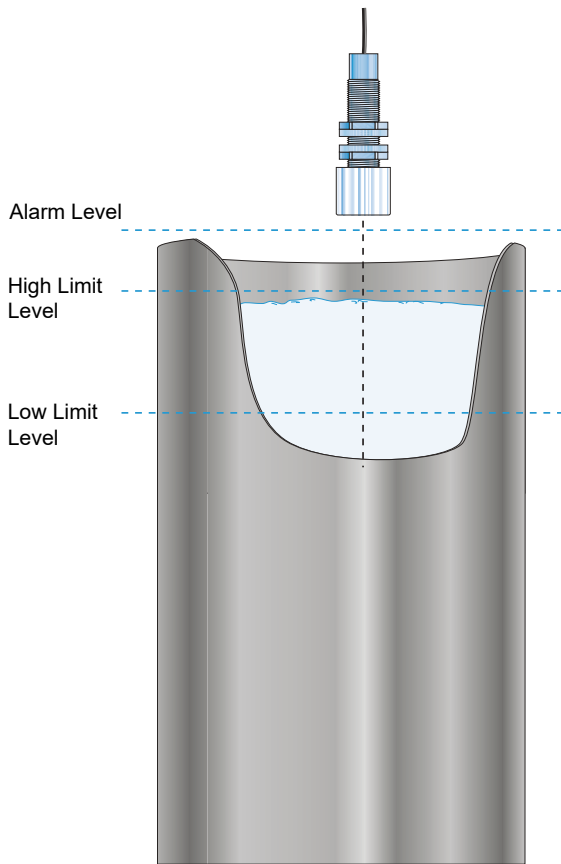

Accurate high speed counting of cylindrical clear objects

XXT18 + XXR18

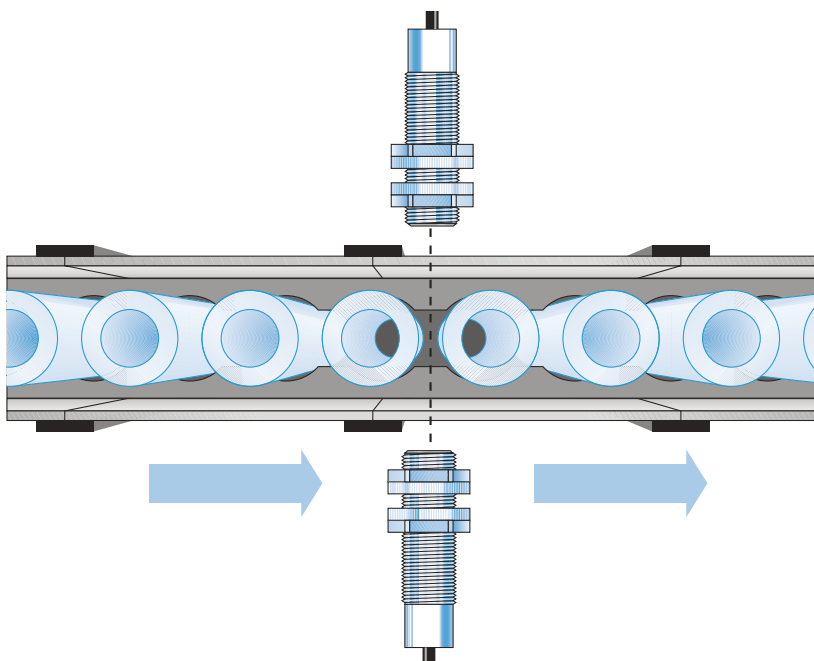

Glue bead detection

XXV18

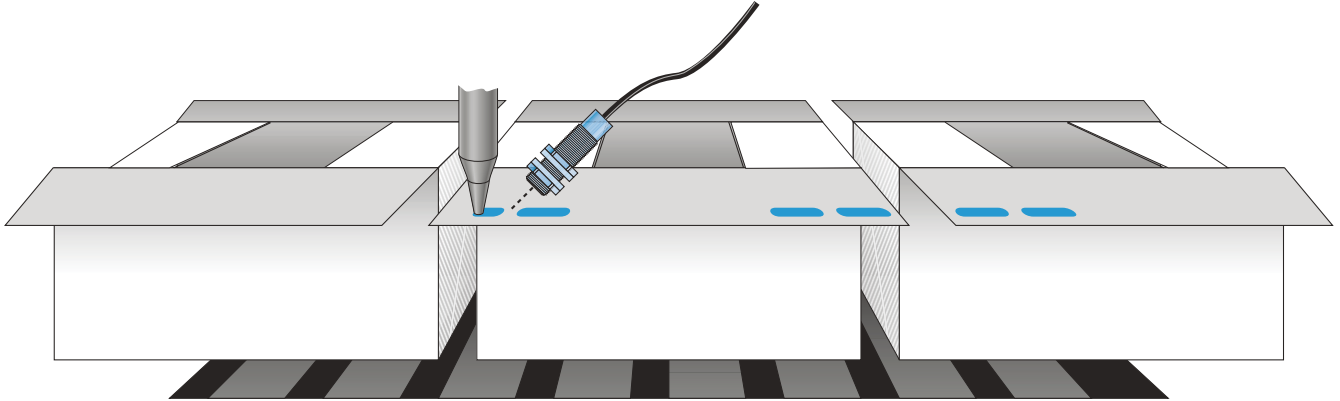

Label edge detection on carrier web

XX7K, XX7F (flat format), XX518A3 (M18)

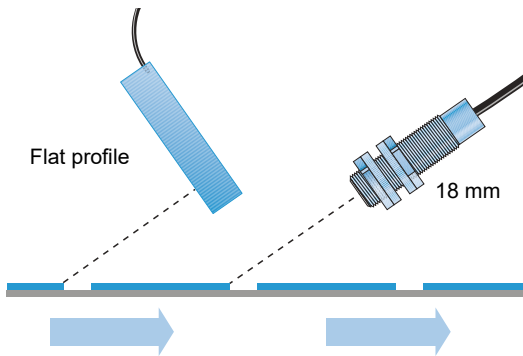

Clear bottle detection for sustainable environments

XXS18, XXA18, XXB18

Broken wire/thread detection

XXV18

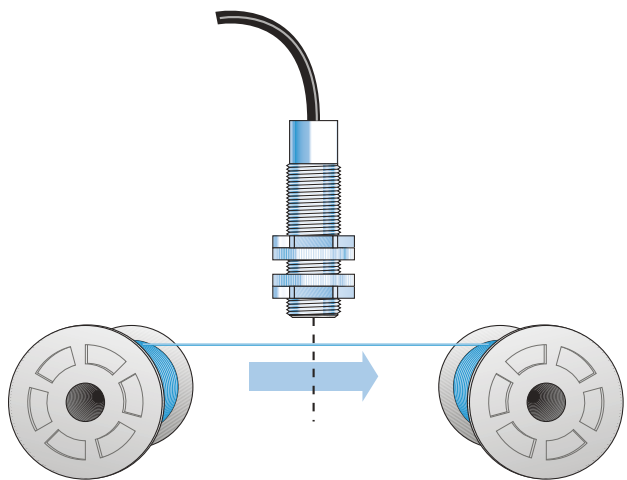
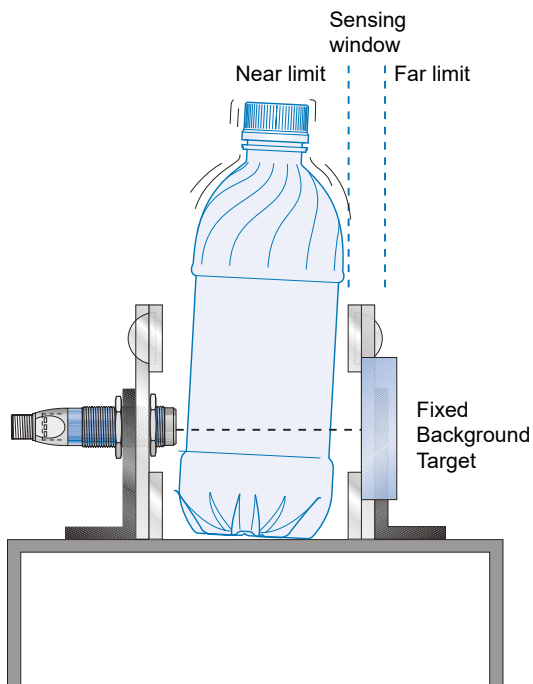

Missing cap detection low cap supply

Automatically stops filler and capper
XX512

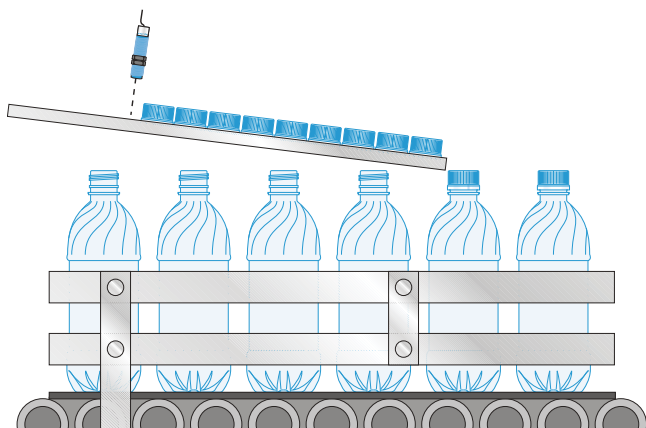

Continuous level monitoring

Analog output sensors
XXS18, XXS30, XX918, XX930

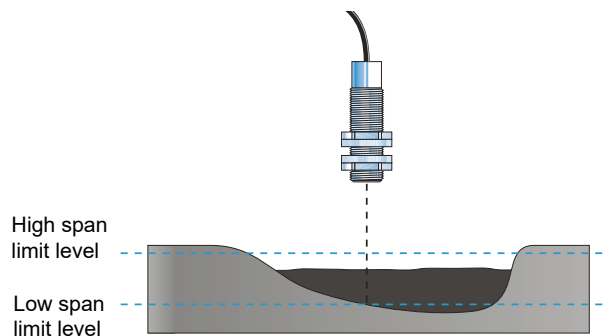

Dual level high-low latch control detection

XXS30●●PM12, XX230

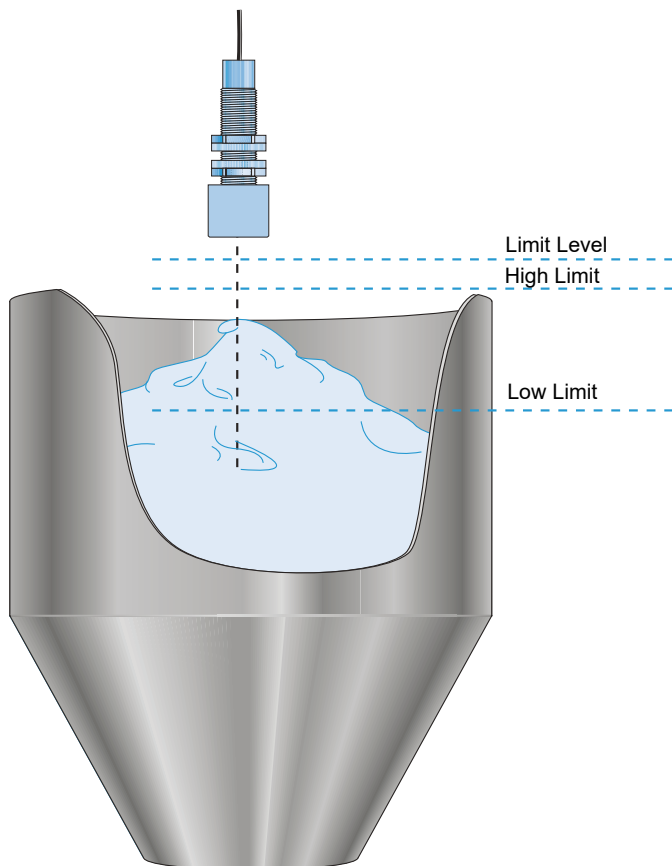

Lead edge or backup detection

XXT18 and XXR18

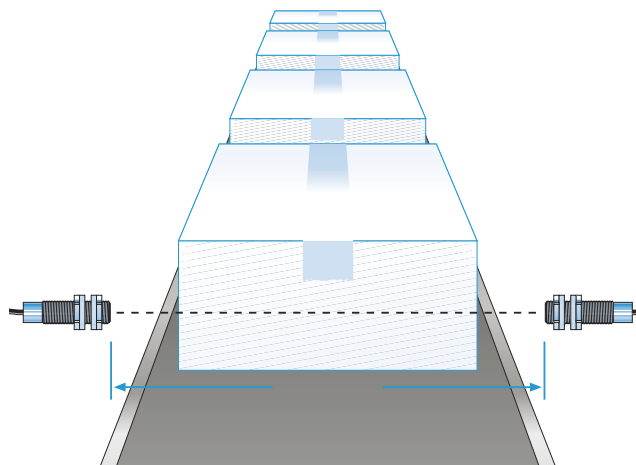

Clear bottle detection

XXT12 and XXR12

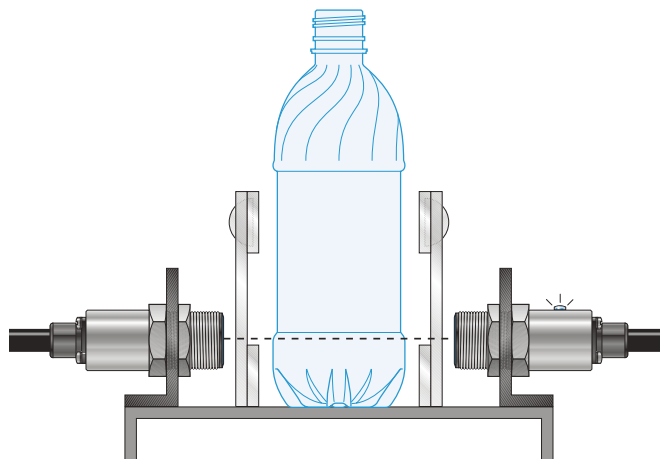

Container detection

XX7F1

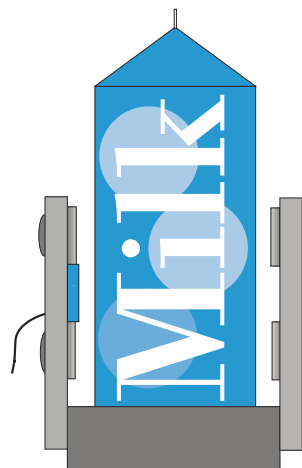

Metal material detection

XX512

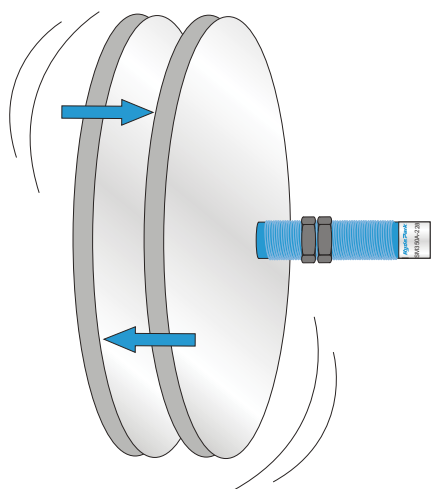

Missing cap detection

XX518

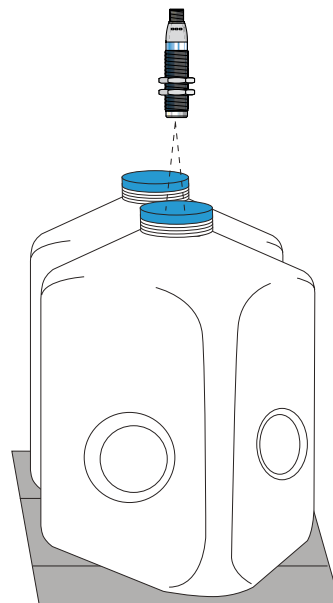

Clear web detection

XX512

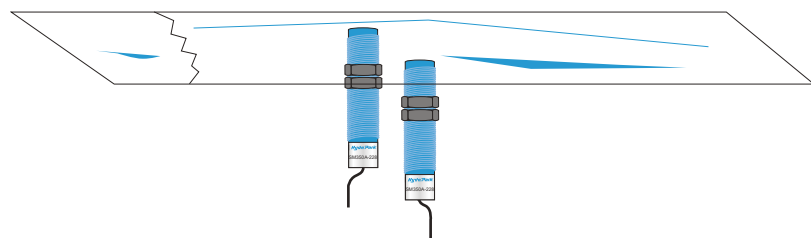

Container detection

XX7F1

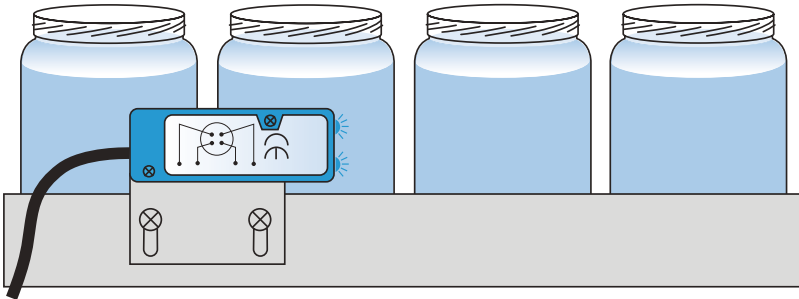

Clear cellophane panel detection

XX7F1A2

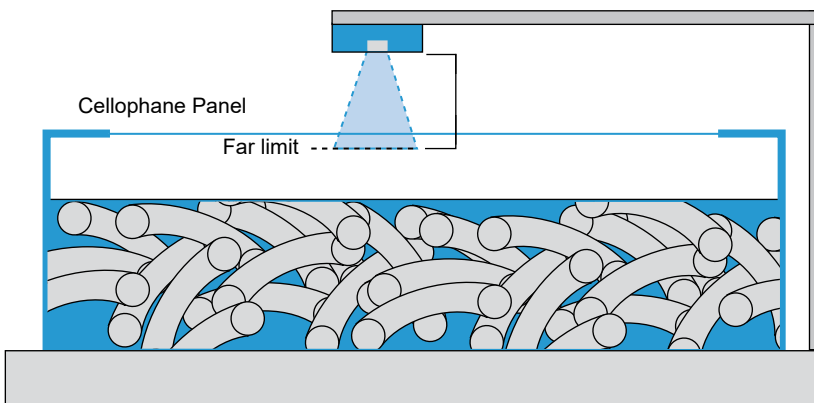

Single file jam protection

Dual level latch control sensor

XX218 and XX230

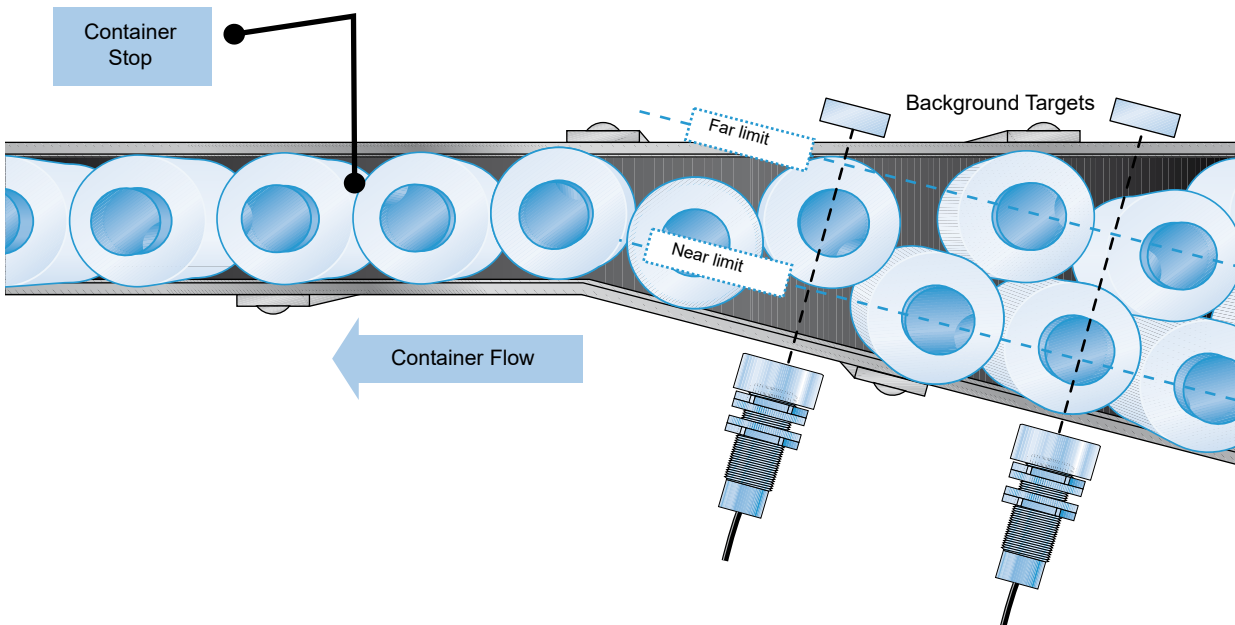

Quality, standards and certifications

Quality control

The XX ultrasonic sensors models are subjected to special precautions in order to guarantee their reliability in arduous industrial environments.

■ Qualification

A **qualification procedure** on the characteristics of XX range ultrasonic sensors is carried out in our laboratories.

■ Production

The electrical characteristics and the sensing distances at the ambient and operating temperatures are 100% verified.

Sensors are statistically selected during the course of production and subjected to **monitoring tests** on all qualified characteristics.

■ Customer returns

Returned ultrasonic sensors are subjected to systematic analysis and corrective actions are implemented to eliminate recurrence of the fault.

Conformity to standards

The XX ultrasonic sensors models conform to the standards IEC 60947-5-2.
Standards and characteristics: refer to pages 23, 27, 32, 38, 41, 45, 46, 50, 54 and 58.

Resistance to chemicals in the environment

To ensure lasting efficient operation, it is essential that any chemicals coming into contact with the ultrasonic sensors will not affect their casing and, in doing so, prevent their reliable operation.

Due to the materials used, the XX ultrasonic sensors models are very resistant to:

■ Chemical agents:

salts, aliphatic and aromatic oils,
petroleum, diluted bases and acids.

Depending on their nature and concentration, tests should be carried out beforehand for the following chemical agents:

alcohols, ketones and phenols.

■ Food and beverage industry products:

vegetable oils, animal fats,
fruit juices,
milk proteins, etc.

Resistance to the environment

■ IP 65: protection against water jets.

Tested in accordance with IEC 60529: the device is subjected to water sprayed from a Ø 6.3 mm nozzle, at a flow rate of 12.5 litres/min for 3 min at a distance of 3 m.
No deterioration in either operating or insulation characteristics is permitted.

■ IP 67: protection against the effects of immersion.

Tested in accordance with IEC 60529: the sensor is immersed for 30 minutes in 1 m of water.
No deterioration in either operating or insulation characteristics is permitted.

■ IP 69K: protection against the effects of high pressure cleaning. Adherence to standard

DIN 40050 which stipulates that the product must withstand a water jet at a pressure of 90 bar and temperature of +80°C for 3 minutes.

No deterioration in either operating or insulation characteristics is permitted.

Recommendations

The ultrasonic sensors are designed for use in standard industrial applications involving presence detection.
 Since these sensors do not incorporate a redundant electrical circuit, they are not suitable for use in safety applications.
 For safety applications, please refer to our website www.tesensors.com

Principle of ultrasonic detection



Presentation

Ultrasonic sensors enable detection, without contact, of objects irrespective of its:

- material (metal, plastic, wood, cardboard, etc.),
- nature (solid, liquid, powder, etc.),
- colour,
- degree of transparency.

They are used in industrial applications for detecting, for example:

- the position of machine parts,
- the presence of the windscreen during automobile assembly,
- the flow of objects on a conveyor system: glass bottles, cardboard packages, cakes, etc.,
- the level
- of different colour paints in pots,
- of plastic pellets in injection moulding machine feeders.

The ultrasonic sensors are simple to install due to their integral connector and availability of cabling and fixing accessories.

Operating principle

The principle of ultrasonic detection is based on measuring the time taken between transmission of an ultrasonic wave (pressure wave) and reception of its echo (return of transmitted wave).

The XX ultrasonic sensors models comprise:

- 1 a high voltage generator
- 2 a piezoelectric transducer (transmitter and receiver)
- 3 a signal processing stage
- 4 an output stage

Excited by the high voltage generator **1**, the transducer (transmitter-receiver) **2** generates a pulsed ultrasonic wave (200 to 500 kHz depending on the product) which travels through the ambient air at the speed of sound. When the wave strikes an object, it reflects (echo) and travels back towards the transducer. A micro controller **3** analyses the signal received and measures the time interval between the transmitted signal and the echo. By comparison with the preset or taught times, it determines and controls the output states **4**.

The output stage **4** controls a solid-state switch (PNP or NPN transistor) corresponding to a NO or NC contact (detection of object).

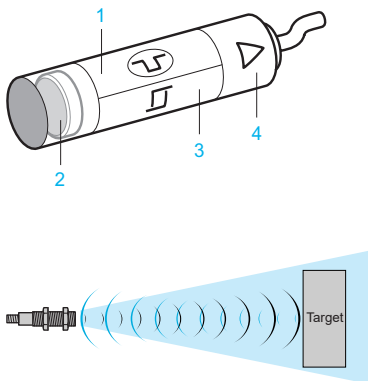

Advantages of ultrasonic detection

- No physical contact with the object to be detected, therefore, no wear and detection possible of fragile and/or freshly painted objects, etc.
- Detection of materials, irrespective of colour, at the same distance, without adjustment or correction factor.
- Teach mode function, by simply pressing a button, for defining the effective detection zone. Teaching of the minimum and maximum sensing distances (very precise foreground and background suppression, ± 6 mm).
- Very good resistance to industrial environments (robust products entirely encapsulated in resin).
- Solid-state units: no moving parts in the sensor, therefore, service life independent of the number of operating cycles.
- Various types of outputs to suit requirements:
 - Digital output for level control or detection of any type of object
 - Analogue output for controlling systems that require a signal that is proportional to the distance at which the object is detected.

Terminology

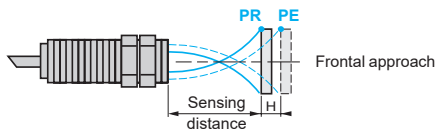
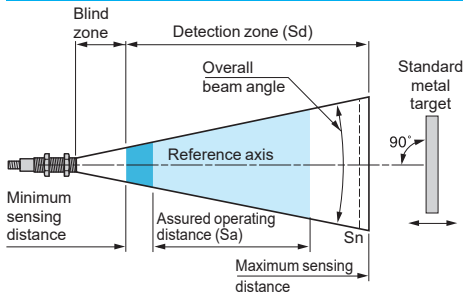

PR = drop-out point
PE = pick-up point

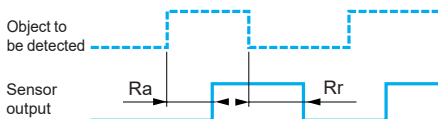
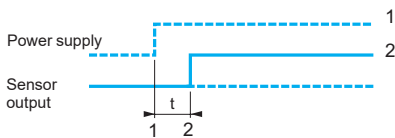
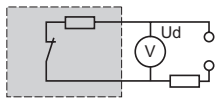

Definitions

The terms listed below are defined by the standard IEC 60947-5-2:

■ **Nominal sensing distance (Sn)**
Conventional value for indicating the sensing distance. It does not take into account manufacturing tolerances nor variations caused by external conditions such as voltage and temperature.

■ **Detection zone (Sd)**
Zone in which the sensor is sensitive to objects.

■ **Minimum sensing distance**
Lower limit of the specified detection zone.

■ **Maximum sensing distance**
Upper limit of the specified detection zone.

■ **Assured operating distance (Sa)**
This corresponds to the operating zone of the sensor (activation of outputs), and is included in the detection zone. It is also known as the "detection window".
Its limits are fixed:

- at the factory for fixed sensing distance sensors,
- when setting-up within the application for sensors with teach mode.

■ **Blind zone:** Zone located in front of the sensing face of the sensor.
For diffuse sensors, it is the zone in which the object will not be reliably detected.
For reflex sensors, it is the zone in which the target (fixed background of machine for example) will not be reliably detected, but the object can be in this zone.
For thru-beam sensors, there is no blind zone.

■ **Differential travel**
The differential travel (H) or hysteresis is the distance between the pick-up point as the standard metal target moves towards the sensor and the drop-out point as it moves away from the sensor.

■ **Repeat accuracy**
The repeat accuracy (R) is the precision of reproduction between two successive measurements of the sensing distance, made in identical conditions.

■ **Overall beam angle**
Fixed angle around the reference axis of an ultrasonic proximity sensor.

■ **Standard metal target**
The standard IEC 60947-5-2 defines the standard target as a square metal plate, 1 mm thick with rolled finish, placed perpendicularly to the reference axis.
Its side dimension depends on the detection zone:

Detection zone (mm)	Size of target (mm)
< 300	10 x 10
300 < d < 800	20 x 20
> 800	100 x 100

■ **Voltage drop (Ud)**
The voltage drop (Ud) corresponds to the voltage at the terminals of the sensor when in the closed state (value measured at the nominal current of the sensor).

■ **First-up delay**
Time required to ensure operation of the sensor's output signal following power-up.
1 Power-up
2 Output signal state (0 or 1)

■ **Response time**
Response time (Ra): time taken between the instant the object to be detected enters the active zone and the changing of the output signal state. This time limits the passing speed of the target in relation to its dimensions.
Recovery time (Rr): time taken between the object being detected leaving the active zone and the changing of the output signal state. This time limits the interval between 2 objects.

Digital outputs

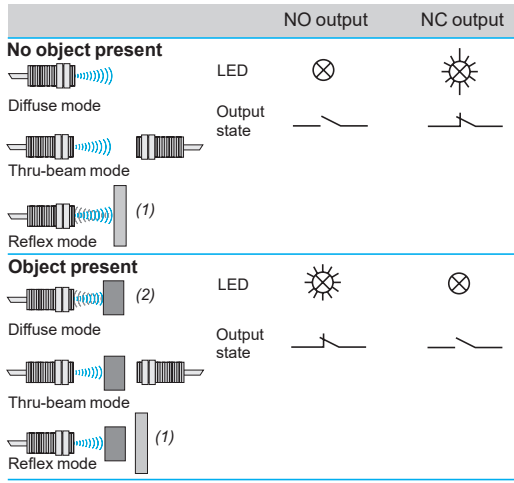

(1) Fixed background of machine
(2) Object

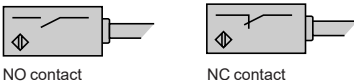

LED indicators

The majority of XX ultrasonic sensors models incorporate light-emitting diode output state indicators.

- Ø 12 sensor
 - Green LED (power on)
 - Yellow LED (object present)
- Ø 18 sensor, sensitivity 500 mm (except thru-beam versions XXT18 and XXR18)
 - Yellow LED (object present) or green LED (power on) + user assistance when adjusting the detection zone
- Ø 30 sensor
 - Multicolour LED for assisting the user when adjusting the detection distance
 - Yellow LED (object present)
 - Analogue version with LED (object present, with luminosity increasing as output signal increases)
- Parallelepiped format sensor
 - XX●F: Dual colour yellow (object present) or green (power on) LED
 - XX●V: Dual colour yellow (object present) or green (power on) LED + user assistance when adjusting the detection zone
 - XX7K: Yellow LED (object present); green LED (power on)
 - XXTK: Yellow LED (object present) only
 - XX●D: Yellow LED (object present); green LED (power on)
 - Analogue version with LED (object present, with luminosity increasing as output signal increases)

Sensors with digital switching

Output contact logic

- NO contact (normally open)
Corresponds to a sensor whose output changes to the closed state when an object is present in the detection window.
- NC contact (normally closed)
Corresponds to a sensor whose output changes to the open state when an object is present in the detection window.

4-wire technique

NO output/PNP and NPN

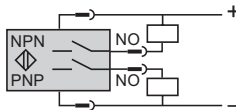

NO + NC output/NPN

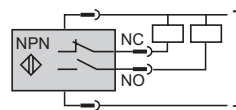

NO + NC output/PNP

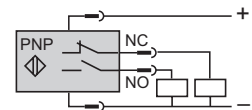

These sensors comprise 2 wires for the supply and 1 wire for each output signal

3-wire technique

NO output/NPN

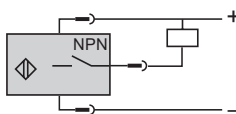

NO output/PNP

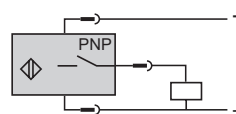

These sensors comprise 2 wires for the supply and 1 wire for the output signal,

- PNP type:** switching the positive side to the load.
- NPN type:** switching the negative side to the load.

Sensors with analogue output

Operation

The characteristic feature of these sensors is the output which delivers a signal (either current or voltage) that is proportional to the distance of the object being detected. Within the detection limits, which are adjustable using teach mode, the value of the output signal increases or decreases in relation to the distance of the object. When an object is detected, an LED indicator (D) illuminates and its luminosity increases in relation to the value of the output signal. The slope of the signal can simply be changed by pressing the teach button

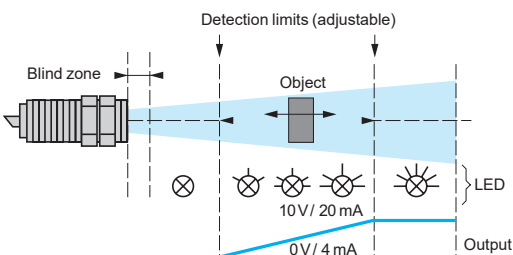

Advantages

- Visual information available relating to the sensor/object distance.
- Protection against reverse polarity.
- Protection against overloads and short-circuits.
- No residual current, low voltage drop.

Power supply

Sensors for DC circuits

- **DC source:** Check that the voltage limits of the sensor and the acceptable level of ripple, are compatible with the supply used.
- **AC source** (comprising transformer, rectifier, smoothing capacitor): The supply voltage must be within the operating limits specified for the sensor.

Where the voltage is derived from a single phase AC supply, the voltage must be rectified and smoothed to ensure that:

- the peak voltage of the DC supply is lower than the maximum voltage rating of the sensor.
- Peak voltage = nominal voltage $\times \sqrt{2}$
- the minimum voltage of the supply is greater than the minimum voltage rating of the sensor,

given that:

$$\Delta V = (I \times t) / C$$

$$\Delta V = \text{max. ripple: } 10\% (V),$$

I = anticipated load current (mA),

t = period of 1 cycle (10 ms full-wave rectified for a 50 Hz supply frequency),

C = capacitance (μF).

As a general rule, use a transformer with a lower secondary voltage (U_e) than the required DC voltage (U).

Example:

18 V \sim to obtain 24 V \dots ,

36 V \sim to obtain 48 V \dots .

Setting-up precautions

For diffuse sensors:

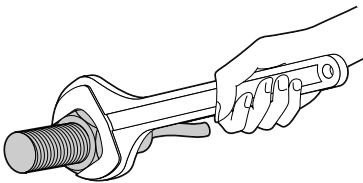
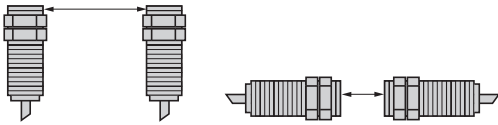

Mounting

Mounting distance between ultrasonic sensors

If 2 standard sensors are mounted too close to each other, the wave transmitted by one sensor is likely to interfere with the other and result in erratic operation.

In order to avoid this, it is necessary to adhere to the minimum distances between sensors. See setting-up precautions.

Maximum tightening torque

Cylindrical sensors	Diameter mm	Tightening torque	Flat sensors	Screw	Tightening Torque
XX●12●	Ø 12	0.7 N.m/ 0.52 lb-ft	XX●F●	M3	0.7 N.m/ 0.52 lb-ft
XX●18●	Ø 18	1 N.m/ 0.74 lb-ft	XX●K●	M4	1 N.m/ 0.74 lb-ft
XX●30●	Ø 30	1.35 N.m/ 1 lb-ft	XX●V●	M3	0.7 N.m/ 0.52 lb-ft
XX●V3●	Ø 30	1.35 N.m/ 1 lb-ft		Ø 18	1 N.m/ 0.74 lb-ft
XXS18*	Ø 18 (Plastic)	2 N.m /			
XXA18*		1.47 lb-ft			
	Ø 18 (Metal)	15 N.m /			
		11.06 lb-ft			

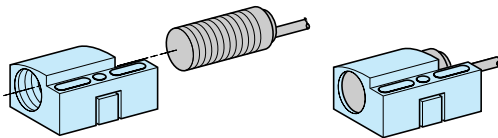

XSZB1●●

Interchangeability

Interchangeability is made easy by using **indexed** fixing clamps:

- XSZB112 (Ø 12 mm),
- XSZB118 (Ø 18 mm),
- XSZB130 (Ø 30 mm),
- XXZB118 (Ø 18 mm),

Cabling

Electrical connection

- **Connect the sensor before switching on the supply**
- **Length of cable**
No limitation up to 200 m or up to a line capacitance of < 0.1 μF . It is, however, advisable to take into account the voltage drop on the line.
- **Separation of control and power cables**
The sensors are immune to electrical interference encountered in normal industrial conditions. Where extreme conditions of electrical "noise" could occur (large motors, spot welders, etc.), it is advisable to protect against transients in the normal way:
 - suppress interference at source,
 - separate power and control wiring from each other,
 - smooth the supply,
 - limit the length of cable.

Setting-up precautions (continued)

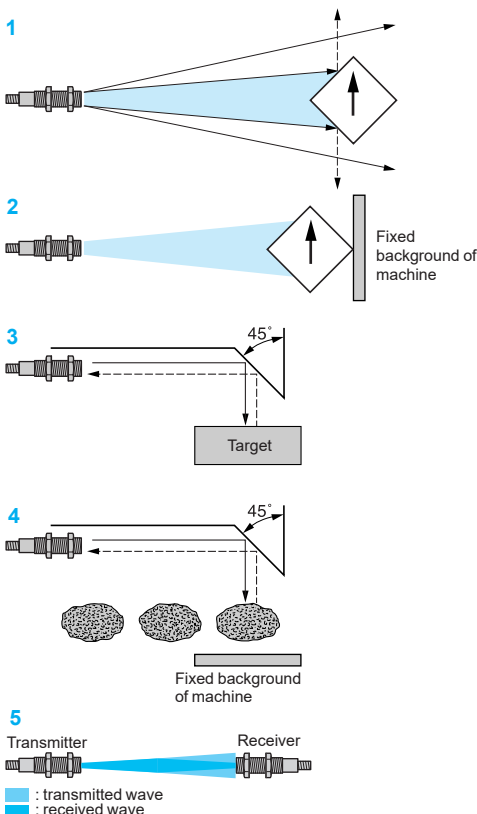
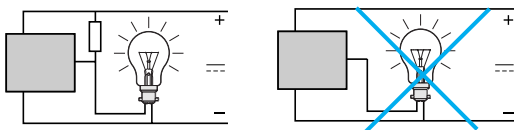
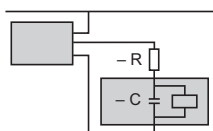
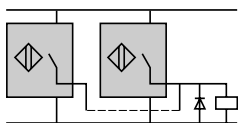
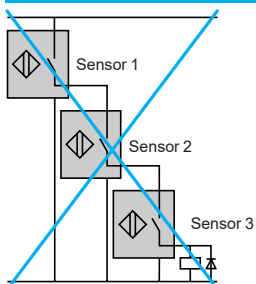

Connection in series

This connection method is not recommended.

- Correct operation of the sensors cannot be assured and, if this method is used, tests should be made before installation.

The following points should be taken into account:

Sensor 1 carries the load current in addition to the no-load current consumption values of the other sensors connected in series. For certain models, this connection method is not possible unless a current limiting resistor is used.

When in the closed state, each sensor will produce a voltage drop and, therefore, the load voltage should be selected accordingly.

As sensor 1 closes, sensor 2 will not operate until a certain time "T" has elapsed (corresponding to the first-up delay) and likewise for the following sensors in the sequence.

"Flywheel" diodes should be used when the load being switched is inductive.

Sensors and units in series with an external mechanical contact

- The following points should be taken into account:

When the mechanical contact is open, the sensor is not supplied.

When the contact closes, the sensor will not operate until a certain time "T" has elapsed (corresponding to the first-up delay).

Connection in parallel

- No specific restrictions. The use of "flywheel" diodes is recommended when an inductive load (relay) is being switched.

Capacitive load (C > 0.1 mF)

- At switch-on, it is necessary to limit (by resistor) the charging current of the capacitive load C. The voltage drop in the sensor can also be taken into account by subtracting it from the supply voltage for calculation of R.

$$R = \frac{U \text{ (supply)}}{I \text{ max. (sensor)}}$$

Load comprising an incandescent lamp

- If the load comprises an incandescent lamp, the cold state resistance can be 10 times lower than the hot state resistance. This can cause very high current levels on switching. Fit a pre-heat resistance in parallel with the sensor.

$$R = \frac{U^2}{P} \times 10, U = \text{supply voltage and } P = \text{lamp power}$$

Detection

Influencing factors

The ultrasonic sensors are particularly suited for the detection of objects that are capable of reflecting an acoustic wave and, in general, having a flat surface perpendicular to the detection axis. However, the correct operation of the ultrasonic sensor can be disrupted by:

- air currents, which can accelerate or divert the acoustic wave transmitted by the sensor (ejection of part by air jet),
- high temperature gradients within the detection zone: an object emitting considerable heat can create zones of varying temperature that will modify the propagation time of the wave and thus prevent reliable operation,
- sound insulators: sound absorbing materials (cotton, fabrics, rubber, etc.),
- the angle between the face of the object to be detected and the reference axis of the sensor: when the angle is offset from 90°, the wave is no longer reflected back along the sensor axis and the operating distance is reduced. The greater the distance between the sensor and the target, the greater the effect. Detection is not possible when the angle exceeds ± 10°.
- the shape of the object to be detected: similar to the example above, an excessively angular object can be difficult to detect 1. In this case, use reflex mode detection.

Detection systems

Diffuse mode

In this mode, it is the object itself that reflects the ultrasonic wave back to the sensor which, in turn, switches its output. It is the most widely used and the most simple mode. In this mode, the object will not be detected in the blind zone.

Reflex or beam break mode

The sensor is in a permanently detecting state on a fixed background of the machine and when the object to be detected breaks the acoustic beam the output switches state 2. This mode is particularly recommended in cases where the shape of the object changes (irregular, angular, non perpendicular) and also for objects that absorb sound (see above). This mode can be achieved by using a diffuse mode sensor (with background teaching) or, more simply, by using a ready to use reflex mode sensor.

In cases where space is restricted, a reflector 3 and 4, angled at 45°, can be used. This system can be used for both the diffuse and reflex modes. This reflector can be a flat part of the machine or a separate element. In this mode, the background of the machine must not be within the blind zone. But if the object is within this zone, it will be reliably detected.

Thru-beam mode

Detection is achieved using both a transmitter and receiver, with the transmitter permanently transmitting an acoustic wave to the receiver. The breaking of the beam by the presence of an object switches the output of the receiver. This mode provides long detection distances 5. In this mode there is no blind zone.

Ultrasonic sensors

XX range, General purpose

Cylindrical, plastic or metal

DC supply, solid-state digital output

121383



XX512A1KAM8

PF13112



XX518A1KAM12

PF51482



XXV18B1PAM12

Diffuse mode

Ø 12 sensors

Sensors	Sensing distance (Sn) m	Function/output	Connection	Reference	Weight kg
Ø 12 Plastic	0.05	NO/PNP + NO/NPN	M8 connector	XX512A1KAM8	0.011
	0.1	NO/NPN	M8 connector	XX512A2NAM8	0.011
		NO/PNP	M8 connector	XX512A2PAM8	0.011

Ø 18 sensors

Ø 18 Plastic	0.15	NO/PNP + NO/NPN	M12 connector	XX518A1KAM12	0.033
Ø 18 Metal	0.05	NO/NPN	Pre-cabled (L = 2 m)	XXV18B1NAL2	0.110
			M12 connector	XXV18B1NAM12	0.050
	NO/PNP	Pre-cabled (L = 2 m)	XXV18B1PAL2	0.110	
		Pre-cabled (L = 5 m)	XXV18B1PAL5	0.200	
	NC/NPN	Pre-cabled (L = 5 m)	M12 connector	XXV18B1PAM12	0.050
			XXV18B1NBL5	0.200	
NC/PNP	Pre-cabled (L = 2 m)	M12 connector	XXV18B1PBL2	0.110	
		XXV18B1PBM12	0.050		

Thru-beam mode

Ø 12 sensors

Transmitter	0.2	–	M8 connector	XXT12A8M8	0.020
Receiver	0.2	NO/PNP + NO/NPN	M8 connector	XXR12A8KAM8	0.020

Sensor type		XX512A1●	XX512A2●	XX●12A8●	XXV18B1●	XX518A1●	
General characteristics							
Conformity to standards		CE, IEC 60947-5-2					
Product certifications		UL	UL	UL	cULus	cULus	
Nominal sensing distance (Sn)	m	0.05	0.1	0.2	0.05	0.15	
Blind zone (in diffuse mode the object is not detected in this zone, in reflex mode the background is not detected in this zone)	mm	0...6.4	0...6.4	–	0...2	0... 19	
Detection window		Fixed				Fixe	
Detection system	Diffuse mode	●	●	–	●	●	
	Reflex mode	–	–	–	–	–	
	Thru-beam mode	–	–	●	–	–	
Transmission frequency (transmitter resonance)	kHz	500			360	200	
Differential travel	mm	< 0.7	< 0.7	–	< 3	–	
Repeat accuracy	mm	± 0.7		± 0.79	± 1.5	± 0.79	
Overall beam angle (see detection lobe)		11°	10°	10°	10°	20	
Minimum size of object to be detected	Cylinder Ø (in mm), at distance (in mm)	Ø 2.5 at 38	Ø 2.5 at 50	Ø 12 at 200	Ø 2.5 at 20	Ø 1.6 at 63	
	Deviation angle from 90° of the object to be detected	± 10°	± 10°	–	± 8°	± 10°	
Materials	Case	ULTEM®			Nickel plated brass	ULTEM®	
		Stainless steel 303 for XX630AS1●●●●					
	Sensing face (1)	Epoxy			Epoxy	Silicone	
Connection	Connector	M8, 4-pin	M8 3-pin	M8, 4-pin	M12, 4-pin	M12, 4-pin	
	Pre-cabled (wire c.s.a.)	–	–	–	3 x 0.34 mm ² / AWG 22	–	
Supply characteristics							
Rated supply voltage	V	12...24 V $\overline{\text{---}}$ with protection against reverse polarity					
Voltage limits (including ripple)	V	$\overline{\text{---}}$ 10...28 V			$\overline{\text{---}}$ 10...36 V	$\overline{\text{---}}$ 10...28 V	
Current consumption, no-load	mA	25		50	15	60	
Output characteristics							
LED indicators	Output state	Yellow LED				–	
	Power on	Green LED				–	
	Setting-up assistance	–	–	–	–	–	
Switching capacity (with overload and short-circuit protection)	mA	< 100			< 200	< 100	
Voltage drop	V	< 1 (NPN), < 1.5 (PNP), 1.1 for XX●12A8, < 2 for XXV18B1●, 0.5 for XX630A2●					
Maximum switching frequency	Hz	125	125	125	80	80	
Delays	First-up	ms	20	20	20	5	350
	Response	ms	2	3	0.4	4	3
	Recovery	ms	2	3	0.4	4	3
Environment characteristics							
Degree of protection	Conforming to IEC 60529 and IEC 60947-5-2	IP 67			IP 65 IP 67 or (2)	IP 67	
Storage temperature	°C	- 40...+ 80					
Operating temperature	°C	- 20...+ 65			0...+ 60	0...+ 50	
Vibration resistance	Conforming to IEC 60068-2-6	Amplitude ± 1 mm (f = 10...55 Hz); ± 2 mm for XXV18B1●					
Mechanical shock resistance	Conforming to IEC 60068-2-27	30 gn, duration 11 ms, in all 3 axes 50 gn, duration 11 ms, in all 3 axes for XXV18B1●					
Resistance to electromagnetic interference		Conforming to IEC 60947-5-2					

(1) Silicone face for optimum chemical resistance.

(2) Double insulation for pre-cabled sensors. IP 69K for sensors with M12 connector.

Dimensions

XX●12A●●●M8

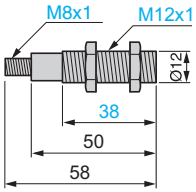

XX518A1KAM12
XXT18A●M12
XXR18A●●●●●

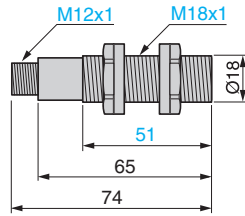

XXV18B1●●●M12

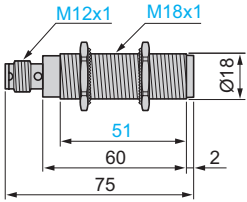

XXV18B1●●L●

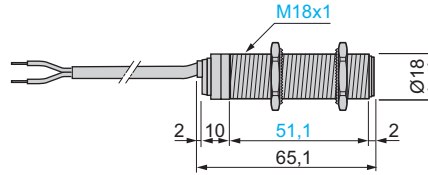

Setting-up precautions

Minimum mounting distances

Diffuse sensors, cylindrical type

Side by side

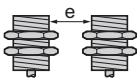

Face to face

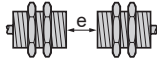

e: respect the distances indicated on the detection curves

$e \geq 4 \times S_n$

XXV18●

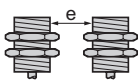

$e > 25 \text{ mm}$

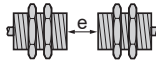

$e > 700 \text{ mm}$

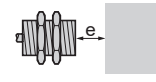

$e > 60 \text{ mm}$

Thru-beam sensors

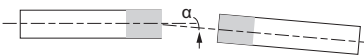

Sensors	α
XX●12●●/XX●F1●●	$\pm 5^\circ$
XX●18A4●●/XX●K1A4	$\pm 10^\circ$
XX●18A2●●/XX●K1A2	

Curves

XX512A1KAM8

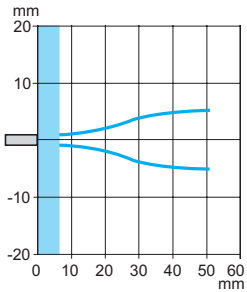

XX512A2●NAM8

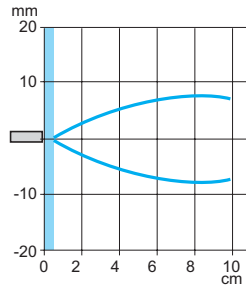

XX518A1KAM12

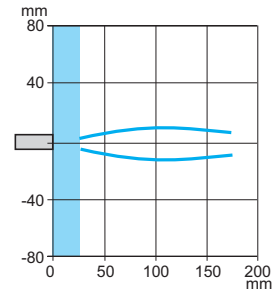

Ultrasonic sensors

XX range, General purpose
Cylindrical, plastic or metal
DC supply, solid-state digital output

Schemes

Digital output, Ø 12 sensor, M8 connector

XX512A1KAM8

4-wire type

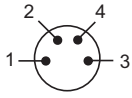

1 (+)
3 (-)
2 PNP output
4 NPN output

NO outputs, PNP and NPN

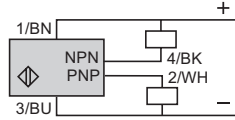

(-) BU (Blue) (+) BN (Brown)
WH (White) BK (Black)

XX512A2●

3-wire type



1 (+)
3 (-)
4 NPN or PNP output

NO outputs, NPN

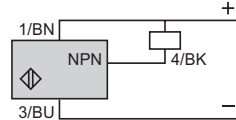

(-) BU (Blue) (+) BN (Brown)
BK (Black)

NO outputs, PNP

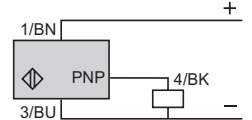

Digital output, Ø 18 sensor, M12 connector, Ø 30 (XX6V3●, XXBV3●)

XXV18B1●●M12

3-wire type

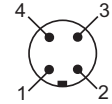

1 (+)
3 (-)

NO outputs, NPN

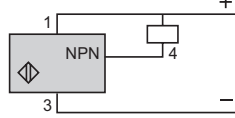

NO outputs, PNP

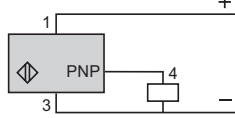

NC outputs, NPN

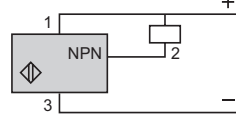

NC outputs, PNP

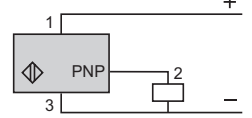

Digital output, Ø 18 sensor, pre-cabled

XXV18B1●●L●

3-wire type

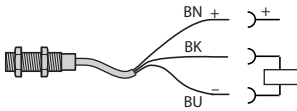

(-) BU (Blue) (+) BN (Brown) BK (Black)

PNP/NO, NC

NPN/NO, NC

XX518A3●●L2

PNP output

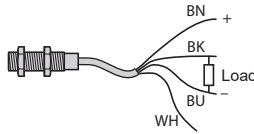

NPN output

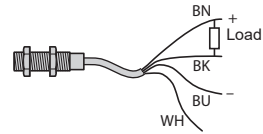

Thru-beam sensors: XXT12●/XXR12●, XXT18●/XXR18●, XXTF1●/XXRF1●

Transmitter

XXT12A8M8, XXT18A3M12

M8

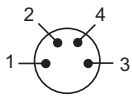

1 (+)
3 (-)

M12

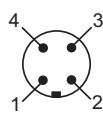

1 (+)
3 (-)

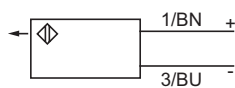

Receiver

XXR12A8KBM8

M8

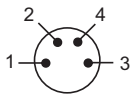

1 (+)
2 (PNP)
3 (-)
4 (NPN)

NPN, PNP, NO

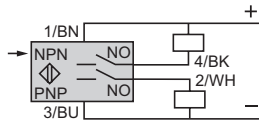

Ultrasonic sensors

XX range, General purpose

Cylindrical, plastic or metal

DC supply, solid-state digital or analog output



XX518A3NAL2



XX918A3C2M12



XXT18A3M12



XXZPB100

Diffuse mode

Ø 18 sensors, digital output

Sensors	Sensing distance (Sn) m	Function/output	Connection	Reference	Weight kg
Ø 18 Plastic	0.5 (adjustable)	NO/NPN	Pre-cabled (L = 2 m)	XX518A3NAL2	0.08
		NO/PNP	Pre-cabled (L = 2 m)	XX518A3PAL2	0.08
		NO/NPN	M12 connector	XX518A3NAM12	0.033
		NO/PNP	M12 connector	XX518A3PAM12	0.033

Ø 18 sensors, analog output

Ø 18 Plastic	0.5	4-20 mA	M12 connector	XX918A3C2M12	0.033
		0-10 V	M12 connector	XX918A3F1M12	0.033

Thru-beam mode

Ø 18 sensors, digital output

Transmitter	0.61	–	M12 connector	XXT18A3M12	0.04
Receiver	0.61	NO/PNP + NO/NPN	M12 connector	XXR18A3KAM12	0.04
Transmitter	1	–	M12 connector	XXT18A4M12	0.04
Receiver	1	NO/PNP + NO/NPN	M12 connector	XXR18A4KAM12	0.04

Accessories

Teach pushbutton

Teach pushbutton	For use with sensors	Reference	Weight kg
Selection of detection window Length of cable: 152 mm Input: M12 female connector Output: M12 male connector	XX918A● XX9V3A● XX9D1A●	XXZPB100	0.035

Ultrasonic sensors

XX range, General purpose

Cylindrical, plastic or metal

DC supply, solid-state digital or analog output

Sensor type		XX●18A3●	XX518A3●
General characteristics			
Conformity to standards		CE, IEC 60947-5-2	
Product certifications		UL	UL, cCSAus
Nominal sensing distance (Sn)		m 0.6	0.5
Blind zone (in diffuse mode the object is not detected in this zone, in reflex mode the background is not detected in this zone)		mm –	0 ... 51 (XX518A3●)
Detection window		Fixed	Remotely adjustable or by using teach button
Detection system	Diffuse mode	–	●
	Reflex mode	–	●
	Thru-beam mode	●	–
Transmission frequency (transmitter resonance)		kHz 300	300
Differential travel		mm < 2.5	< 2.5
Repeat accuracy		mm ± 1.27	± 1.27
Overall beam angle (see detection lobe)		6°	6°
Minimum size of object to be detected		–	
Cylinder Ø (in mm), at distance (in mm)		Ø 38 to 600 Ø 114 to 1 000	Ø 2.5 to 150
Deviation angle from 90° of the object to be detected		–	± 7°
Materials	Case	ULTEM®	Valox®
	Sensing face (1)	Silicone	Epoxy
Connection	Connector	M12, 4-pin	M12, 4-pin
	Pre-cabled (wire c.s.a.)	–	4 x 0.08 mm ² / AWG 28

(1) Silicone face for optimum chemical resistance.

Dimensions

XX518A3●AM12, XXT18A●M12, XXR18A●KAM12

XX518A3●AL2

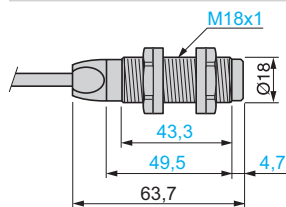
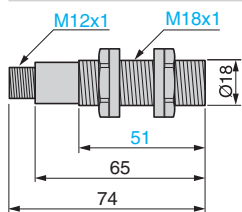

XX918A3●M12

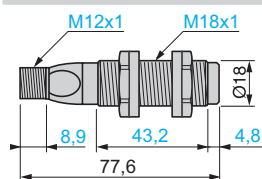

Setting-up precautions

Minimum mounting distances

Diffuse sensors, cylindrical type

Side by side

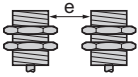

Face to face

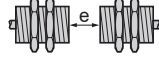

e: respect the distances indicated on the detection curves

$$e \geq 4 \times S_n$$

XXV18●

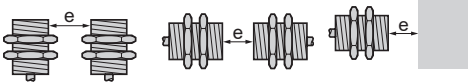

$e > 25 \text{ mm}$

$e > 700 \text{ mm}$

$e > 60 \text{ mm}$

Thru-beam

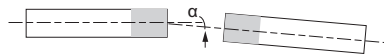

Sensors

XX●18A4●●/XX●K1A4

α

$\pm 10^\circ$

Curves

XX518A3●●L2,
XX518A3●AM12,
XX918A3●●M12

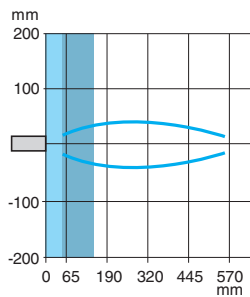

Blind zone for diffuse sensors.

Blind zone for reflex sensors.

Schemes

Digital output, $\varnothing 18$ sensor, M12 connector

XX518A3●

3-wire type

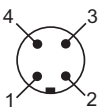

1 (+) 2 Teach input (WH)
3 (-) 4 NPN or PNP output

NO outputs, NPN

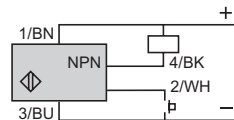

(-) BU (Blue) (+) BN (Brown)
BK (Black)

NO outputs, PNP

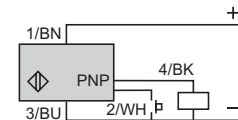

Ultrasonic sensors

XX range, General purpose

Cylindrical, plastic or metal, Ø 18 mm

Diffuse mode, solid-state digital or analog output

Configurable by software



XXA18P1•M12



XXS18P1•M12



XXA18B1•M12
XXA18S1•M12



XXS18B1•M12
XXS18S1•M12



XXZPB100

Diffuse mode

Sensors with solid-state digital output, M12 connector

Sensors	Sensing distance (Sn) Adjustable	Function/output	Sensing axis	Reference	Weight
	m				kg
Ø 18 Plastic	1	NO or NC (1)/ PNP	Straight	XXS18P1PM12	0.033
			90° angled	XXA18P1PM12	0.040
Ø 18 Nickel-plated brass	1	NO or NC (1)/ PNP	Straight	XXS18B1PM12	0.050
			90° angled	XXA18B1PM12	0.055
Ø 18 Stainless steel 316L	1	NO or NC (1)/ PNP	Straight	XXS18S1PM12	0.050
			90° angled	XXA18S1PM12	0.055

Sensors with analog output, M12 connector

Sensors	Sensing distance (Sn) Adjustable	Analog output (2)	Sensing axis	Reference	Weight		
	m				kg		
Ø 18 Plastic	1	4-20 mA	Straight	XXS18P1AM12	0.033		
			90° angled	XXA18P1AM12	0.040		
		0-10 V	Straight	XXS18P1VM12	0.033		
			90° angled	XXA18P1VM12	0.040		
		Ø 18 Nickel-plated brass	1	4-20 mA	Straight	XXS18B1AM12	0.050
					90° angled	XXA18B1AM12	0.055
Ø 18 Stainless steel 316L	1	4-20 mA	Straight	XXS18S1AM12	0.050		
			90° angled	XXA18S1AM12	0.055		

Accessories

Description	For use with sensor	Reference	Weight
			kg
Teach pushbutton Input: M12 female connector Output: M12 male connector	XXS18●● XXA18●●	XXZPB100	0.035

Configuration interface and configuration kit for the synchronization function

See page 74.

(1) Output function (NO or NC) and mode (window, reflex, proximity, pump) are selectable using the XXZPB100 remote teach pushbutton.

(2) Selectable using the XXZPB100 remote teach pushbutton.

Ultrasonic sensors

XX range, General purpose

Cylindrical, plastic or metal, Ø 18 mm

Diffuse mode, solid-state digital or analog output

Configurable by software



PFI120213

XZCPV11V12L●●



PFI120214

XZCPV12V12L●●



XZ_524_CPMF517008

XZCP1141L●



XZ_524_CPMF517006

XZCP1241L●



PFI122322

XZCC12FDM50B



XZCC12FCM50B

XZCC12FCM50B



XX_519_CPF-JR16005

XXZB118

Accessories

Description	Type	Length m	Reference	Weight kg
Connection accessories for synchronization function				
Pre-wired connector 5-pin, 5-wire female M12 connector/ bare wires PVC cable	Straight	2	XZCPV11V12L2	0.090
		5	XZCPV11V12L5	0.201
		10	XZCPV11V12L10	0.360
	Elbowed	2	XZCPV12V12L2	0.090
		5	XZCPV12V12L5	0.201
		10	XZCPV12V12L10	0.360

Connection accessories without synchronization function

Pre-wired connector 5-pin, 4-wire female M12 connector/ bare wires PVC cable	Straight	2	XZCP1141L2	0.090
		5	XZCP1141L5	0.190
		10	XZCP1141L10	0.370
	Elbowed	2	XZCP1241L2	0.090
		5	XZCP1241L5	0.190
		10	XZCP1241L10	0.370
Female M12 connector 5-pin, Pg 7 cable gland	Straight	–	XZCC12FDM50B	0.020
	Elbowed	–	XZCC12FCM50B	0.020

Mounting accessory

Description	For use with sensor	Reference	Weight kg
Fixing clamp (1)	XXS18●● XXA18●●	XXZB118	0.010

(1) Recommended to use in applications below 0°C.

Ultrasonic sensors

XX range, General purpose

Cylindrical, plastic or metal, Ø 18 mm

Diffuse mode, solid-state digital or analog output

Configurable by software

Sensor type		XX●18●1PM12	XX●18●1AM12	XX●18●1VM12
General characteristics				
Conformity to standards		EN/IEC 60947-5-2, UL 508, and CSA C22.2 n°14		
Compliance with regulations		CE (based on EMC directive 2014/30/EU), NEC (ANSI/NFPA 70), CEC (CSA C22), UNECE R10		
Product certifications		cULus with class 2 power supply, E2, EAC, and RCM		
Nominal sensing distance (Sn)		m	1 (adjustable)	
Blind zone (in diffuse mode the object is not detected in this zone)		m	0.105	
Detection window		Remotely adjustable or by using external teachbutton XXZPB100		
Transmission frequency (transmitter resonance)		kHz	200	
Differential travel		mm	< 5	–
Repeat accuracy (repeatability)		0.1 %		
Minimum size of object to be detected		Cylinder Ø 1 mm up to sensing distance of 0.6 m		
Tilt angle with 100 x 100 mm target		± 7° at 1 m, ± 35° at 0.5 m, ± 10° at 0.9 m		
Materials	Case	XX●18P●●: PBT XX●18B●●: Nickel-plated brass XX●18S●●: Stainless steel 316L		
	Sensing face	Epoxy, polyurethane, and butyl		
Connection		M12 connector - 5-pin		
Supply characteristics				
Rated supply voltage (Ue) with protection against reverse polarity		V	12...24 V $\overline{\text{---}}$	24 V $\overline{\text{---}}$
Voltage limits (including ripple)		V	10...30 V $\overline{\text{---}}$	10...30 V $\overline{\text{---}}$
Current consumption, no-load		mA	< 30	< 30
Output characteristics				
LED indicators	Output state		Yellow LED	Yellow LED
	Echo state		Green LED	Green LED
Switching capacity (with overload and short-circuit protection)			< 100 mA	–
Resistive load impedance		Ω	–	12 V $\overline{\text{---}}$, load ≤ 250 Ω 24 V $\overline{\text{---}}$, load ≤ 850 Ω
Voltage drop		V	< 2	–
Internal temperature compensation			Yes	Yes
Maximum switching frequency		Hz	11	–
Delays	First-up	ms	120	180
	Response	ms	45	–
	Recovery	ms	45	100
Environment characteristics				
Degree of protection Conforming to IEC 60529 and EN/IEC 60947-5-2			IP 65, IP 67	
Storage temperature		°C	-40...+ 80	
Operating temperature		°C	-25...+ 70 (1)	
Relative humidity			< 95%, without condensation	
Vibration resistance Conforming to IEC 60068-2-6			Amplitude ± 1 mm (f = 10...55 Hz)	
Mechanical shock resistance Conforming to IEC 60068-2-27			30 gn, duration 11 ms, in all 3 axes	
Resistance to electromagnetic interference			Conforming to EN/IEC 60947-5-2 and UNECE R10-05	

(1) For applications below 0°C, it is recommended to use the **XXZB118** fixing clamp (see page 31).

Ultrasonic sensors

XX range, General purpose

Cylindrical, plastic or metal, Ø 18 mm

Diffuse mode, solid-state digital or analog output

Configurable by software

Operating diagrams for digital output sensors

Settings with teach procedure

Window mode

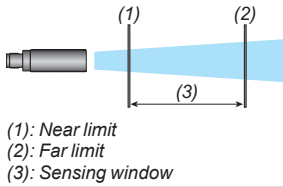

Reflex mode

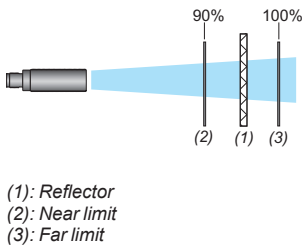

Proximity mode

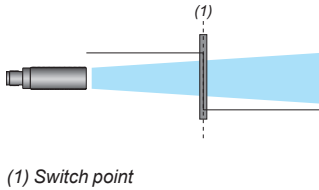

Pump/Hysteresis mode

Emptying (stored in high threshold memory)

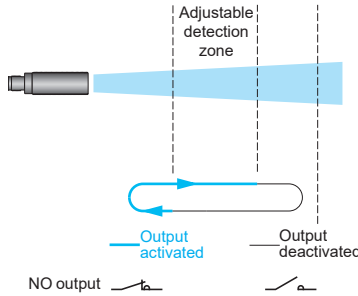

Filling (stored in low threshold memory)

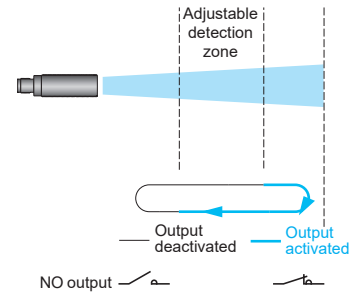

Operating diagram for analog output sensors

Near and far limits setting with teach procedure

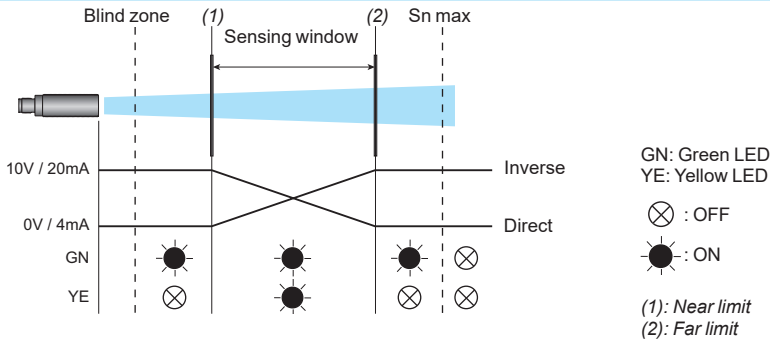
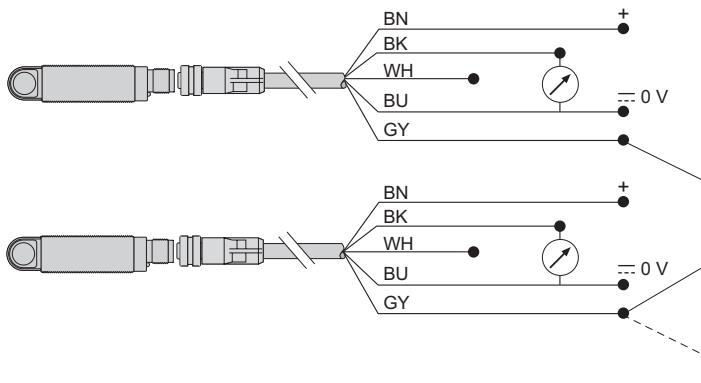

Diagram for the synchronization function (side by side application)



NB: To enable synchronization between several sensors, all of the wires of pin no.5 (gray) must be electrically connected together. A maximum of 8 sensors can be synchronized. To enable "Multiplexer" function for the sensors, use the XX Configuration Software. Without synchronization or multiplexing, the sensors must be at least 50 cm away from each other in order to avoid mutual interference.

Ultrasonic sensors

XX range, General purpose

Cylindrical, plastic or metal, Ø 18 mm

Diffuse mode, solid-state digital or analog output

Configurable by software

Curves

Detection curve with 100 x 100 mm square target

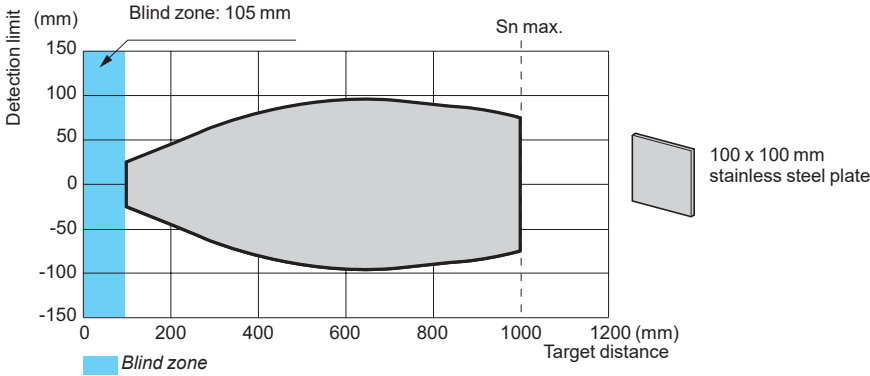

Detection curve with round bar

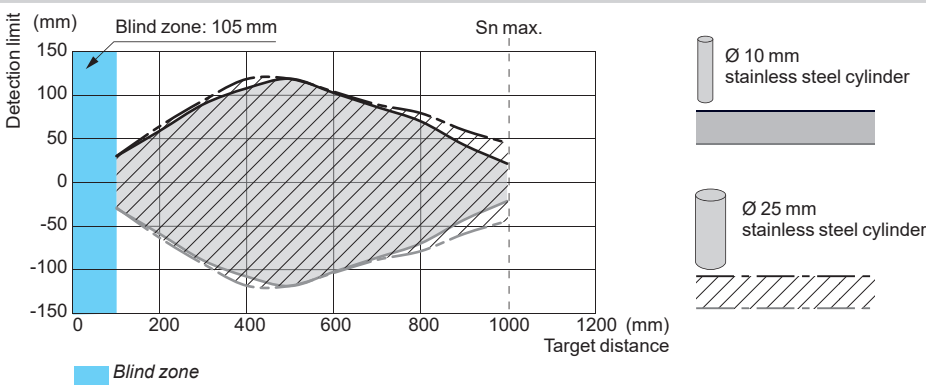

Dimensions

Plastic sensors, straight

XXS18P1●M12

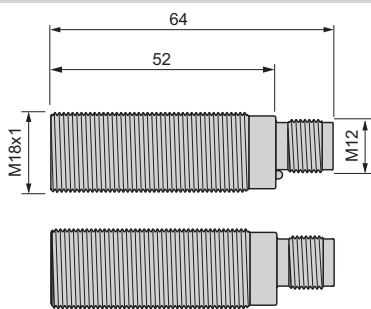

Plastic sensors, 90° angled

XXA18P1●M12

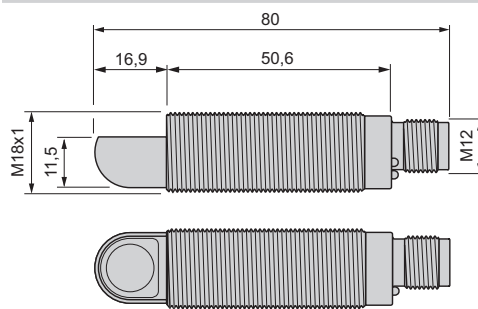

Nickel-plated brass and stainless steel sensors, straight

XXS18B1●M12 and XXS18S1●M12

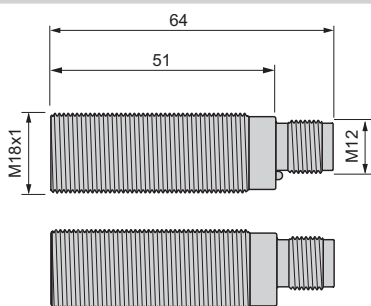

Nickel-plated brass and stainless steel sensors, 90° angled

XXA18B1●M12 and XXA18S1●M12

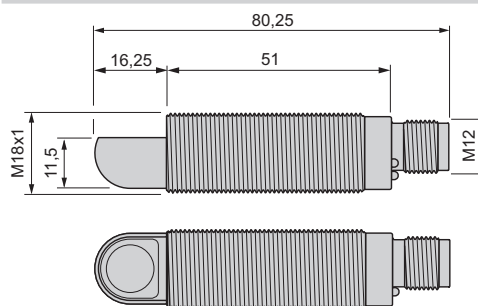

Ultrasonic sensors

XX range, General purpose

Cylindrical, plastic or metal, Ø 18 mm

Diffuse mode, solid-state digital or analog output

Configurable by software

Dimensions (continued)

Fixing clamp XXZB118

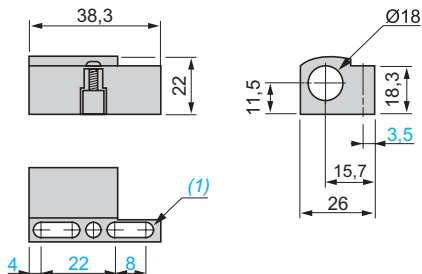

(1) 2 elongated holes Ø 4 X 8 mm

Teach pushbutton XXZPB100

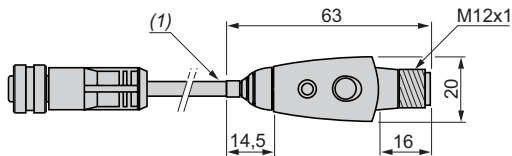

(1) Cable length: 152 mm

Connections

Connector wiring

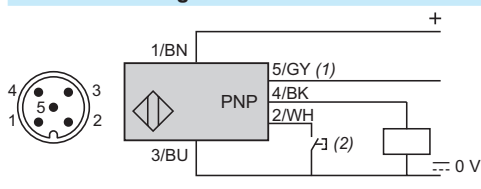

Pin number	Wire color	Digital output description	Analog output description	
			4-20 mA	0-10 V
1	BN: Brown	+12...24 V \square	+12...24 V \square	+14...24 V \square
2	WH: White	Input teach		
3	BU: Blue	0 V \square		
4	BK: Black	Output		
5	GY: Gray	Synchronization		

(1) Synchronization.

(2) External setting pushbutton or XXZPB100 remote teach pushbutton (see page 30).

Wiring scheme (digital output NO or NC)

XXS18•1PM12 and XXA18•1PM12

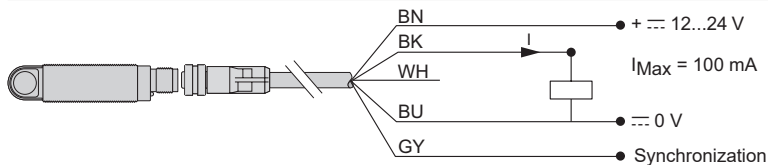

Wiring scheme (analog output 4-20 mA)

XXS18•1AM12 and XXA18•1AM12

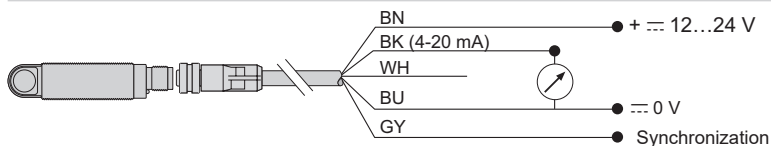

4-20 mA:

\square For 12 V \square , load \leq 250 Ω

\square For 24 V \square , load \leq 850 Ω

Wiring scheme (analog output 0-10 V)

XXS18•1VM12 and XXA18•1VM12

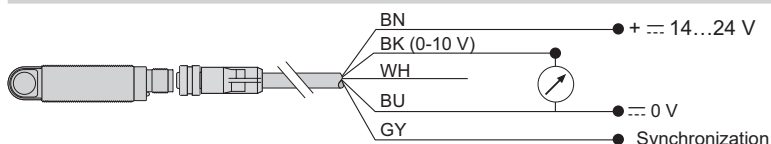

0-10 V:

1 k Ω ... ∞

Ultrasonic sensors

XX range, General purpose

Cylindrical, plastic or metal

DC supply, solid-state digital or analog output



Diffuse mode

Solid-state digital output, M12 connector

Sensors	Sensing distance (Sn) m	Function/output	Reference	Weight kg
Ø 30 Plastic	1 (adjustable)	NO/PNP + NO/NPN	XX630A1KAM12	0.09
		NO/NPN	XX6V3A1NAM12	0.09
	2 (adjustable)	NO/PNP	XX6V3A1PAM12	0.09
		NO/NPN + NC/NPN	XX630A1NCM12	0.09
		NO/PNP + NC/PNP	XX630A1PCM12	0.09
		NO/NPN + NC/NPN	XX630A2NCM12	0.09
8 (adjustable)	NO/NPN + NC/NPN	XX630A3NCM12	0.11	
	NO/PNP + NC/PNP	XX630A3PCM12	0.11	
Ø 30 Stainless steel 303	1 (adjustable)	NO/NPN + NC/NPN	XX630S1NCM12	0.09
		NO/PNP + NC/PNP	XX630S1PCM12	0.09

Standard analogue output, M12 connector

Sensors	Sensing distance (Sn) m	Analogue output (Slope selection using teach button)	Reference	Weight kg
Ø 30 Plastic	1	4-20 mA	XX930A1A2M12	0.095
		0-10 V	XX930A1A1M12	0.095
		4-20 mA	XX9V3A1C2M12	0.090
	2	0-10 V	XX9V3A1F1M12	0.090
		4-20 mA	XX930A2A2M12	0.095
		0-10 V	XX930A2A1M12	0.095
8	4-20 mA	XX930A3A2M12	0.115	
	0-10 V	XX930A3A1M12	0.115	
Ø 30 Stainless steel 303	1	4-20 mA	XX930S1A2M12	0.095
		0-10 V	XX930S1A1M12	0.095

250 ms delayed analogue output (for unstable object), M12 connector

Ø 30 Plastic	1	4-20 mA	XX930A1A2230M12	0.095
	2	4-20 mA	XX930A2A2230M12	0.095

Ultrasonic sensors

XX range, General purpose
Cylindrical, plastic or metal
DC supply, solid-state digital output

Sensor type	XX6V3A1●	XX630A1● XX630A2● XX630S1●	XX630A3●	XX930A1● XX930A2● XX930S1●	XX930A3●	XX9V3A1●	
General characteristics							
Conformity to standards	CE, IEC 60947-5-2			CE, IEC 60947-5-2			
Product certifications	UL, cCSAus (1)			UL, cCSAus			
Nominal sensing distance (Sn)	m	1	1 or 2 (2)	8	1 or 2 (3)	8	1
Blind zone (in diffuse mode the object is not detected in this zone, in reflex mode the background is not detected in this zone)	mm	0 ...100	0...51 (XX630●1) 0...120 (XX630A2●)	0...300	0...51 or 0...120 (3)	0...300	0...100
Detection window		Remotely adjustable or by using external teach button	Adjustable using teach button on sensor		Adjustable using teach button on sensor		Remotely adjustable or by using external teach button
Detection system	Diffuse	●	●	●	–	–	–
	Reflex	●	–	–	–	–	–
	Thru-beam	–	–	–	–	–	–
Transmission frequency (transmitter resonance)	kHz	180	200	75	200	75	180
Differential travel	mm	< 2.5	< 2.5	< 12.7			
Repeat accuracy	mm	± 1.6	± 0.87	± 2.54	± 0.9	± 2.54	± 0.9 1.6mm
Overall beam angle (see detection lobe)		7°	10°	16°	10°	16°	7°
Minimum size of object to be detected		Cylinder Ø 50 mm at distance 1 m	Cylinder Ø 1.6 mm at distance 635 mm	Cylinder Ø 51 mm at distance 4732 mm	Cylinder Ø 1.6 mm up to a sensing distance of 635 mm	Cylinder Ø 51 mm up to a sensing distance of 4732 mm	Cylinder Ø 50 mm up to a sensing distance of 1 m
Deviation angle from 90° of the object to be detected		± 5°	± 7° or ± 10° (2)	± 5°	± 8°	± 5°	± 5°
Materials	Case	Valox®	ULTEM®	ULTEM®	ULTEM® : XX930A1● and XX930A2●	ULTEM®	Valox®
		Stainless steel 303 for XX630AS1●●●●			Stainless steel 303: XX930S1●	–	
	Sensing face (4)	Epoxy	Silicone	Epoxy	Silicone	Epoxy	
Connection		M12 connector, 4-pin					

(1) Only XX6V3A1●, XX630A1●, XX630A2●, XX630S1● and XX630A3● sensors are cCSAus certified.

(2) The first value is given for XX630A1● and XX630S1●, the second value for XX630A2●.

(3) The first value is given for XX930A1● and XX930S1●, the second value for XX930A2●.

(4) Silicone face for optimum chemical resistance.

Ultrasonic sensors

XX range, General purpose
Cylindrical, plastic or metal
DC supply, solid-state digital output

Sensor type		XX6V3A1●	XX630A1● XX630A2● XX630S1●	XX630A3●	XX930A1● XX930A2● XX930S1●	XX930A3●	XX9V3A1●	
Supply characteristics								
Rated supply voltage	V	12...24 V $\overline{\text{---}}$ with protection against reverse polarity			$\overline{\text{---}}$ 15...24 V	$\overline{\text{---}}$ 15...24 V	$\overline{\text{---}}$ 15...24 V	
Voltage limits (including ripple)	V	$\overline{\text{---}}$ 10...28 V			$\overline{\text{---}}$ 10...28 V	–		
Current consumption, no-load	mA	60	50 or 100 (1)	50	60 or 80 (2)	60	60	
Output characteristics								
LED indicators	Output state	Yellow LED			Yellow LED	–		
	Power on	Green LED			Green LED	–		
	Setting-up assistance	Multicolour LED			Dual colour LED	–		
Slope type		–			Direct or inverse by using teach button XXZPB100			
Switching capacity (with overload and short-circuit protection)	mA	< 100			–	–		
Voltage drop	V	< 100			–	–		
Maximum switching frequency	Hz	70	10 or 16 (1)	2	–	–		
Delays	First-up	ms	75	720	800	720	1 200	75
	Response	ms	15	20 or 25 (1)	200			
	Recovery	ms	75	20	200	250 (delayed) 50 (standard)	250	180
Resistive load impedance	4-20 mA	Ω	–			10...500		10...350
	0-10 V	Ω	–			1 k... ∞		2 k... ∞
Environment characteristics								
Degree of protection	Conforming to IEC 60529 and IEC 60947-5-2	IP 67	IP 65 or IP 67 (1) IP67 for plastic versions. IP65 for stainless steel versions.	IP 67	IP 67	IP 67	IP 67	
Storage temperature	°C	-40...+80						
Operating temperature	°C	0...+70	0...+60 or 0...+50 (1)	-20...+60	0...+50	-20...+60	0...+70	
Vibration resistance	Conforming to IEC 60068-2-6	Amplitude \pm 1 mm (f = 10...55 Hz); \pm 2 mm for XXV18B1●			Amplitude \pm 1 mm (f = 10...55 Hz)			
Mechanical shock resistance	Conforming to IEC 60068-2-27	30 gn, duration 11 ms, in all 3 axes 50 gn, duration 11 ms, in all 3 axes for XXV18B1●			30 gn, duration 11 ms, in all 3 axes			
Resistance to electromagnetic interference		Conforming to IEC 60947-5-2						

(1) The first value is given for XX630A1● and XX630S1●, the second value for XX630A2●.

(2) The first value is given for XX930A1● and XX930S1●, the second value for XX930A2●.

Dimensions

XX630A1●●M12
XX630S1●●M12
XX630A2●●M12
XX930A1A●M12
XX230A1●●A00M12
XX230A2●●A00M12

XX6V3A1●AM12
XX9V3A1●●M12

XX630A3●●M12
XX930A3A●M12

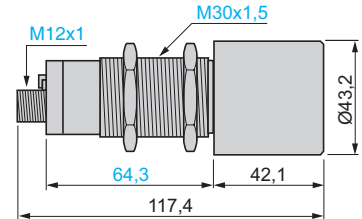
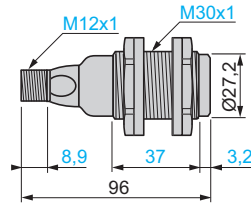
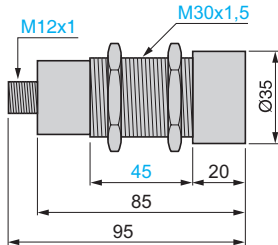

Curves

XXV18B1●

Square object

Cylindrical object

XX630A2●CM12

XX630A3●CM12

XX930A3●●M12

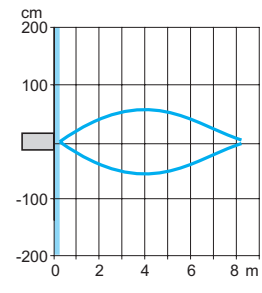
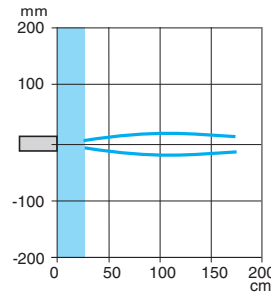
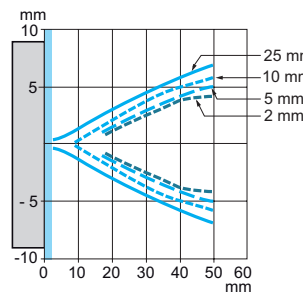
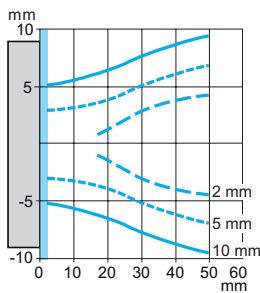

XX230A2●

XX230A1●, XX630A1●CM12, XX6V3A1●AM12, XX930A1●●M12, XX9V3A1●●M12, XX8D1A1●AM12, XXBD1A1●AM12

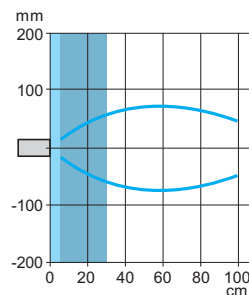
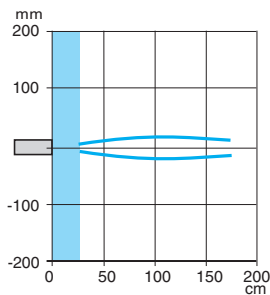

Blind zone for diffuse sensors
Blind zone for reflex sensors

Ultrasonic sensors

XX range, Application

Sensors for monitoring 2 levels

Cylindrical plastic case, M18 x 1 and M30 x 1.5

DC supply, solid-state digital output



XX218A3P●M12



XX230A12NA00M12

Sensors for monitoring 2 levels

Sensors	Sensing distance (Sn) m	Function/output	Reference	Weight kg
Ø 18, threaded M18 x 1				
2 emptying levels	0.5 (adjustable)	NO/PNP	XX218A3PHM12	0.035
2 filling levels	0.5 (adjustable)	NO/PNP	XX218A3PFM12	0.035
Ø 30, threaded M30 x 1.5				
2 levels 2 independent outputs	1 (adjustable)	NO/NPN + NO/NPN	XX230A12NA00M12	0.090
		NO/PNP + NO/PNP	XX230A12PA00M12	0.090
	2 (adjustable)	NO/PNP + NO/PNP	XX230A22PA00M12	0.090
2 emptying levels	1 (adjustable)	NO/PNP + NO/PNP	XX230A10PA00M12	0.090
	2 (adjustable)	NO/PNP + NO/PNP	XX230A20PA00M12	0.090
2 filling levels	1 (adjustable)	NO/PNP + NO/PNP	XX230A11PA00M12	0.090
	2 (adjustable)	NO/PNP + NO/PNP	XX230A21PA00M12	0.090

Accessories

Teach pushbutton

Teach pushbutton	For use with sensors	Reference	Weight kg
Selection of detection window Length of cable: 152 mm Input: M12 female connector Output: M12 male connector	XX218A3●	XXZPB100	0.035

Other connection and fixing accessories

See page 78.

Dimensions

XX218A3P●M12

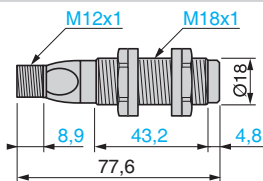

XX230A1●●A00M12
XX230A2●●A00M12

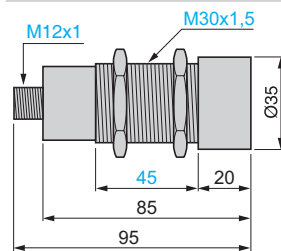

Curves

XX218A3●●M12

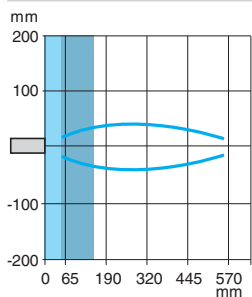

XX230A1●●●●●M12

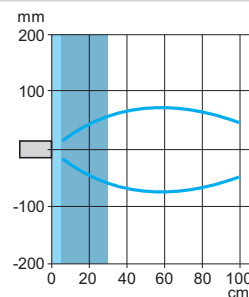

XX230A2●●●●●M12

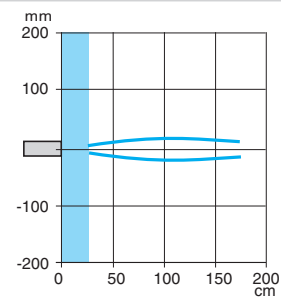

Blind zone for diffuse sensors.

Blind zone for reflex sensors.

Ultrasonic sensors

XX range, Application

Sensors for monitoring 2 levels

Cylindrical plastic case, M18 x 1 and M30 x 1.5

DC supply, solid-state digital output

Sensor type		XX218A3●●●●	XX230A1●●●●	XX230A2●●●●	
General characteristics					
Conformity to standards		CE, IEC 60947-5-2			
Product certifications		UL, cCSAus	UL, cCSAus	UL, cCSAus	
Nominal sensing distance (Sn)	m	0.50 (adjustable)	1 (adjustable)	2 (adjustable)	
Blind zone (no object must pass through this zone whilst the sensor is operating)	mm	0...51	0...51	0...120	
Detection window		Remotely adjustable or by using external teach button	Adjustable using teach button on sensor		
Transmission frequency	kHz	300	200		
Differential travel	mm	< 2.5	< 2.5	< 2.5	
Repeat accuracy	mm	± 1.27	± 0.9		
Overall beam angle (see detection lobe)		6°	10°	10°	
Minimum size of object to be detected		Cylinder Ø 2.5 mm up to a sensing distance of 150 mm	Cylinder Ø 1.6 mm up to a sensing distance of 305 mm		
Deviation angle from 90° of the object to be detected		± 7°	± 10° on 305 x 305 mm		
Materials	Case	Valox®	ULTEM®		
	Sensing face (1)	Epoxy	Silicone		
Connection	Connector	M12, 4-pin			
Supply characteristics					
Rated supply voltage	V	12...24 V $\overline{\text{DC}}$ with protection against reverse polarity			
Voltage limits (including ripple)	V	10...28 V $\overline{\text{DC}}$			
Current consumption, no-load	mA	40	100		
Output characteristics					
LED indicators	Output state		Yellow LED	Multicolour LED	
	Power on		Green LED	–	
	Setting-up assistance		Dual colour LED	Multicolour LED	
	Distance indication		–	Yellow LED	
Switching capacity	mA	< 100 (PNP and NPN) with overload and short-circuit protection			
Voltage drop	V	< 1 (PNP and NPN)			
Delays	First-up	ms	100	1000	1000
	Response	ms	15	150	150
	Recovery	ms	1000	1000	1000
Environment characteristics					
Degree of protection	Conforming to IEC 60529 and IEC 60947-5-2		IP 67	IP 65	
Storage temperature		°C	- 40...+ 80	- 10...+ 80	
Operating temperature		°C	- 20...+ 65	0...+ 50	
Vibration resistance	Conforming to IEC 60068-2-6		Amplitude ± 1 mm (f = 10...55 Hz)		
Mechanical shock resistance	Conforming to IEC 60068-2-27		30 gn, duration 11 ms, in all 3 axes		
Resistance to electromagnetic interference			Conforming to IEC 60947-5-2		

(1) Silicone face for optimum chemical resistance.

Ultrasonic sensors

XX range, General purpose

Cylindrical, plastic or metal, Ø 30 mm

Diffuse mode, solid-state digital or analog output

Configurable by software



XXA30P1PM12
XXS30P1PM12



XXS30B2PM12
XXA30S2PM12

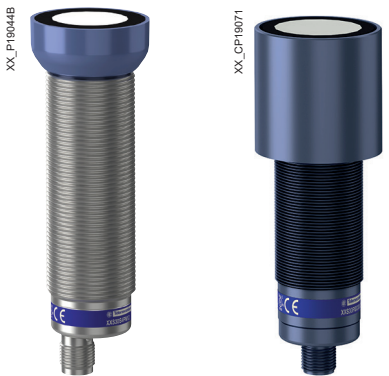

XXS30S4PM12
XXS30P8●●M12



XXS30P1AM12
XXS30P2AM12

Diffuse mode

Sensors with solid-state digital output, M12 connector

Sensors	Sensing Function/ distance output (Sn)		Sensing axis	Reference	Weight kg
	m				
Ø 30 Plastic	1	NO or NC (1)/PNP	Straight	XXS30P1PM12	0.047
			90° angled	XXA30P1PM12	0.100
	2	NO or NC (1)/PNP	Straight	XXS30P2PM12	0.095
			90° angled	XXA30P2PM12	0.100
	4	NO or NC (1)/PNP	Straight	XXS30P4PM12	0.115
	8	NO or NC (1)/PNP x 2	Straight	XXS30P8PPM12	0.210
NO or NC (1)/NPN x2			XXS30P8NNM12	0.210	
Ø 30 Nickel-plated brass	1	NO or NC (1)/PNP	Straight	XXS30B1PM12	0.165
			90° angled	XXA30B1PM12	0.175
	2	NO or NC (1)/PNP	Straight	XXS30B2PM12	0.165
			90° angled	XXA30B2PM12	0.175
	4	NO or NC (1)/PNP	Straight	XXS30B4PM12	0.195
	Ø 30 Stainless steel 316L	1	NO or NC (1)/PNP	Straight	XXS30S1PM12
90° angled				XXA30S1PM12	0.170
2		NO or NC (1)/PNP	Straight	XXS30S2PM12	0.160
			90° angled	XXA30S2PM12	0.170
4		NO or NC (1)/PNP	Straight	XXS30S4PM12	0.190

Sensors with analog output, adjustable sensing distance, M12 connector

Sensors	Sensing Function/ distance output (Sn)		Sensing axis	Reference	Weight kg	
	m					
Ø 30 Plastic	1	4-20 mA	Straight	XXS30P1AM12	0.047	
			0-10 V	XXS30P1VM12	0.047	
		90° angled	XXA30P1AM12	0.100		
			XXA30P1VM12	0.100		
		2	4-20 mA	Straight	XXS30P2AM12	0.095
				0-10 V	XXS30P2VM12	0.095
	90° angled	XXA30P2AM12	0.100			
		XXA30P2VM12	0.100			
	4	4-20 mA	Straight	XXS30P4AM12	0.115	
			0-10 V	XXS30P4VM12	0.115	
	8	4-20 mA + PNP (2)	Straight	XXS30P8APM12	0.210	
			0-10 V + PNP (2)	XXS30P8VPM12	0.210	

(1) NO or NC: configurable by software (see page 74).

(2) One analogic output and one digital output with NO or NC configurable by software (see page 74).

Ultrasonic sensors

XX range, General purpose

Cylindrical, plastic or metal, Ø 30 mm

Diffuse mode, solid-state digital or analog output

Configurable by software



XXS30B1AM12
XXA30B1AM12



XXS30S2AM12
XXA30B2AM12



XXS30B4AM12
XXS30S1AM12



XXZPB100

Diffuse mode (continued)

Sensors with analog output, adjustable sensing distance, M12 connector

Sensors	Sensing distance	Function/ output	Sensing axis	Reference	Weight
	(Sn) m				
Ø 30 Nickel-plated brass	1	4-20 mA	Straight	XXS30B1AM12	0.165
		0-10 V	Straight	XXS30B1VM12	0.165
		4-20 mA	90° angled	XXA30B1AM12	0.175
	2	0-10 V	90° angled	XXA30B1VM12	0.175
		4-20 mA	Straight	XXS30B2AM12	0.165
		0-10 V	Straight	XXS30B2VM12	0.165
Ø 30 Stainless steel 316L	4	4-20 mA	90° angled	XXA30B2AM12	0.175
		0-10 V	90° angled	XXA30B2VM12	0.175
		4-20 mA	Straight	XXS30B4AM12	0.195
	1	0-10 V	Straight	XXS30B4VM12	0.195
		4-20 mA	Straight	XXS30S1AM12	0.160
		0-10 V	Straight	XXS30S1VM12	0.160
2	4-20 mA	90° angled	XXA30S1AM12	0.170	
	0-10 V	90° angled	XXA30S1VM12	0.170	
	4-20 mA	Straight	XXS30S2AM12	0.160	
	0-10 V	Straight	XXS30S2VM12	0.160	
	4-20 mA	90° angled	XXA30S2AM12	0.170	
	0-10 V	90° angled	XXA30S2VM12	0.170	
4	4-20 mA	Straight	XXS30S4AM12	0.190	
	0-10 V	Straight	XXS30S4VM12	0.190	

Accessories

Teach pushbutton	For use with sensors	Reference	Weight kg
Selection of detection window Length of cable: 152 mm Input: M12 female connector Output: M12 male connector	XXS30●● XXA30●●	XXZPB100	0.035

Configuration interface and configuration kit for the synchronization function

See page 74.

Ultrasonic sensors

XX range, General purpose

Cylindrical, plastic or metal, Ø 30 mm

Diffuse mode, solid-state digital or analog output

Configurable by software



XZCPV11V12L2



XZCPV12V12L2

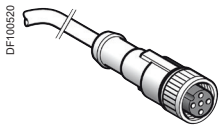

XZCPV1164L10



XZCC12FDM50B



XXZB130

Accessories (continued)

Description	Type	Length	Reference	Weight kg
Pre-wired connector 5-pin, 5-wire female M12 connector/bare wires PVC cable	Straight	2	XZCPV11V12L2	0.090
		5	XZCPV11V12L5	0.201
		10	XZCPV11V12L10	0.360
	Elbowed	2	XZCPV12V12L2	0.090
		5	XZCPV12V12L5	0.201
		10	XZCPV12V12L10	0.360

Connection accessories without synchronization function

Pre-wired connector 5-pin, 5-wire female M12 connector/bare wires PVC cable	Straight	2	XZCPV1164L2	0.090
		5	XZCPV1164L5	0.190
		10	XZCPV1164L10	0.370
	Elbowed	2	XZCPV1264L2	0.090
		5	XZCPV1264L5	0.201
		10	XZCPV1264L10	0.360
Female M12 connector 5-pin, Pg 7 cable gland	Straight	–	XZCC12FDM50B	0.020
			XZCC12FDM50B	0.020

Mounting accessory

Description	For use with sensor	Weight kg
Fixing clamp	XXS30●●	XXZB130
	XXA30●●	

Configuration interface and configuration kit for the synchronization function

See page 74.

Ultrasonic sensors

XX range, General purpose

Cylindrical, plastic or metal, Ø 30 mm, 1 m sensing distance. Diffuse mode, solid-state digital or analog output. Configurable by software

Sensor type		XXS30P1PM12	XXS30P1AM12	XXS30P1VM12
General characteristics				
Conformity to standards		EN/IEC 60947-5-2, UL 508, and CSA C22.2 n°14		
Compliance with regulations		CE (based on EMC directive 2014/30/EU), NEC (ANSI/NFPA 70), CEC (CSA C22), UNECE R10		
Product certifications		cULus with class 2 power supply, E2, EAC, RCM, and ECOLAB		
Nominal sensing distance (Sn)		m	1 (adjustable)	
Blind zone (in diffuse mode the object is not detected in this zone)		m	0.105	
Detection window		Remotely adjustable or by using external teachbutton XXZPB100		
Transmission frequency (transmitter resonance)		kHz	200	
Differential travel		mm	< 5	–
Repeat accuracy (repeatability)			0.1 %	
Minimum size of object to be detected		Cylinder Ø 1 mm up to sensing distance of 0.6m		
Tilt angle with 100 x 100 mm target		± 7° at 1 m, ± 10° at 0.9 m ± 35° at 0.5 m		
Materials	Case	XX●30P●: PBT		
	Sensing face	Epoxy, resin, and rubber		
Connection		M12 connector - 5-pin		
Supply characteristics				
Rated supply voltage (Ue) with protection against reverse polarity		V	≐ 12...24 V	≐ 12...24 V
Voltage limits (including ripple)		V	≐ 10...30 V	≐ 14...30 V
Current consumption, no-load		mA	< 30	< 30
Output characteristics				
LED indicators	Output state		Yellow LED	Yellow LED
	Echo state		Green LED	Green LED
Switching capacity (with overload and short-circuit protection)			< 100 mA	–
Resistive load impedance		Ω	–	≐ 12 V, load ≤ 250 Ω ≐ 24 V, load ≤ 850 Ω
Voltage drop		V	< 2	–
Internal temperature compensation			Yes	Yes
Maximum switching frequency		Hz	11	–
Delays	First-up	ms	120	180
	Response	ms	45	–
	Recovery	ms	45	100
Environment characteristics				
Degree of protection Conforming to IEC 60529 and EN/IEC 60947-5-2			IP 65, IP 67	
Storage temperature		°C	- 40...+ 80	
Operating temperature		°C	- 25...+ 70	
Relative humidity			< 95%, without condensation	
Vibration resistance Conforming to IEC 60068-2-6			Amplitude ± 1 mm (f = 10...55 Hz)	
Mechanical shock resistance Conforming to IEC 60068-2-27			30 gn, duration 11 ms, in all 3 axes	
Resistance to electromagnetic interference			Conforming to EN/IEC 60947-5-2 and UNECE R10-05	

Ultrasonic sensors

XX range, General purpose
Cylindrical, plastic or metal, Ø 30 mm, 1 m sensing distance. Diffuse mode, solid-state digital or analog output. Configurable by software

Sensor type	XXA30P1PM12 XX●30B1PM12 XX●30S1PM12	XXA30P1AM12 XX●30B1AM12 XX●30S1AM12	XXA30P1VM12 XX●30B1VM12 XX●30S1VM12
General characteristics			
Conformity to standards	EN/IEC 60947-5-2, UL 508, and CSA C22.2 n°14		
Compliance with regulations	CE (based on EMC directive 2014/30/EU), NEC (ANSI/NFPA 70), CEC (CSA C22), UNECE R10		
Product certifications	cULus with class 2 power supply, E2, EAC, RCM, and ECOLAB		
Nominal sensing distance (Sn)	m	1 (adjustable)	
Blind zone (in diffuse mode the object is not detected in this zone)	m	0.155	
Detection window	Remotely adjustable or by using external teachbutton XXZPB100		
Transmission frequency (transmitter resonance)	kHz	120	
Differential travel	mm	< 5	-
Repeat accuracy (repeatability)		0.1 %	
Minimum size of object to be detected	Cylinder Ø 1 mm up to sensing distance of 1m		
Tilt angle with 100 x 100 mm target	± 12° at 1 m, ± 15° at 0.9 m ± 45° at 0.5 m		
Materials	Case	XX●30P●: PBT XX●30B●: Nickel-plated brass XX●30S●: Stainless steel 316L	
	Sensing face	Epoxy, resin, and rubber	
Connection	M12 connector - 5-pin		
Supply characteristics			
Rated supply voltage (Ue) with protection against reverse polarity	V	12...24 V $\overline{\text{---}}$	12...24 V $\overline{\text{---}}$
Voltage limits (including ripple)	V	10...30 V $\overline{\text{---}}$	14...30 V $\overline{\text{---}}$
Current consumption, no-load	mA	< 65	< 65
Output characteristics			
LED indicators	Output state	Yellow LED	Yellow LED
	Echo state	Green LED	Green LED
Switching capacity (with overload and short-circuit protection)		< 100 mA	-
Resistive load impedance	Ω	-	$\overline{\text{---}}$ 12 V, load ≤ 250 Ω $\overline{\text{---}}$ 24 V, load ≤ 850 Ω
Voltage drop	V	< 2	-
Internal temperature compensation		Yes	Yes
Maximum switching frequency	Hz	11	
Delays	First-up	ms	120
	Response	ms	45
	Recovery	ms	45
Environment characteristics			
Degree of protection Conforming to IEC 60529 and EN/IEC 60947-5-2		IP 65, IP 67	
Storage temperature	°C	- 40...+ 80	
Operating temperature	°C	- 25...+ 70	
Relative humidity		< 95%, without condensation	
Vibration resistance Conforming to IEC 60068-2-6		Amplitude ± 1 mm (f = 10...55 Hz)	
Mechanical shock resistance Conforming to IEC 60068-2-27		30 gn, duration 11 ms, in all 3 axes	
Resistance to electromagnetic interference		Conforming to EN/IEC 60947-5-2 and UNECE R10-05	

Ultrasonic sensors

XX range, General purpose

Cylindrical, plastic or metal, Ø 30 mm, 1 m sensing distance. Diffuse mode, solid-state digital or analog output. Configurable by software

Operating diagrams for digital output sensors

Settings with teach procedure

Window mode

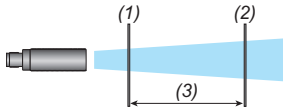

- (1): Near limit
- (2): Far limit
- (3): Sensing window

Reflex mode

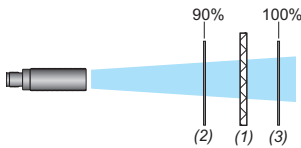

- (1): Reflector
- (2): Near limit
- (3): Far limit

Proximity mode

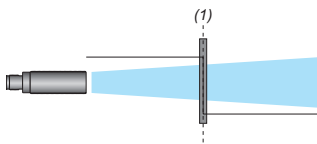

- (1) Switch point.

Pump/Hysteresis mode

Emptying (stored in high threshold memory)

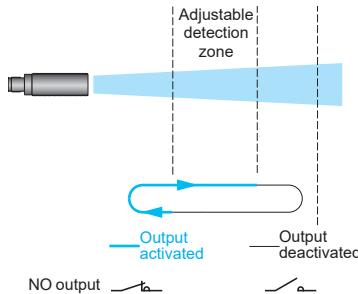

Filling (stored in low threshold memory)

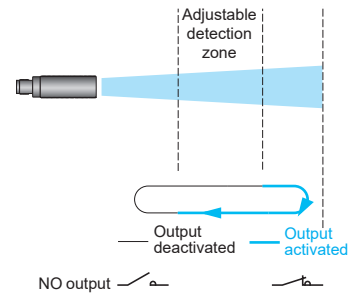

Operating diagram for analog output sensors

Near and far limits setting with teach procedure

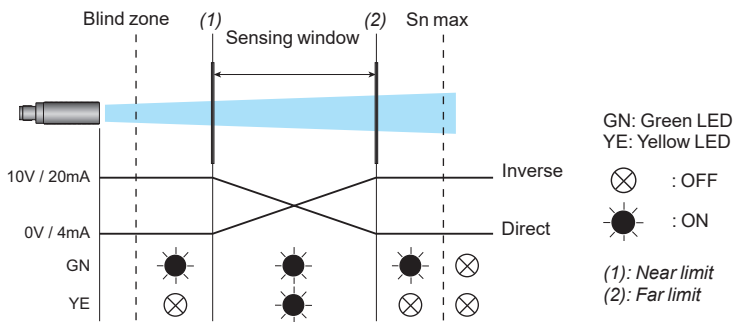
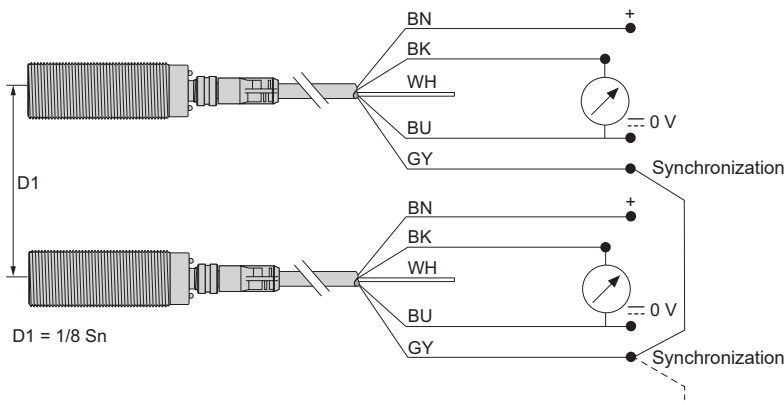

Diagram for the synchronization function (side by side application)



NB: To enable synchronization between several sensors, all of the wires of pin no.5 (gray) must be electrically connected together. A maximum of 8 sensors can be synchronized. To enable "Multiplexer" function for the sensors, use the XX Configuration Software. Without synchronization or multiplexing, the sensors must be at least 50 cm away from each other in order to avoid mutual interference.

Ultrasonic sensors

XX range, General purpose

Cylindrical, plastic or metal, Ø 30 mm, 1 m sensing distance. Diffuse mode, solid-state digital or analog output. Configurable by software

Dimensions

XXA30●1●M12

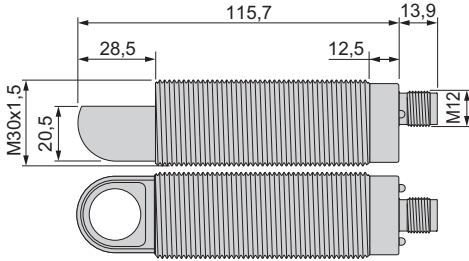

XXS30B1●M12, XXS30S1●M12

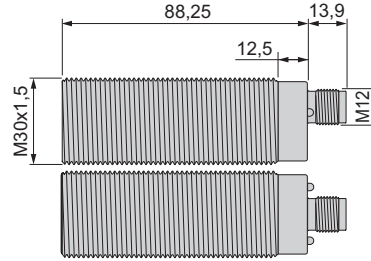

XXS30P1PM12, XXS30P1AM12, XXS30P1VM12

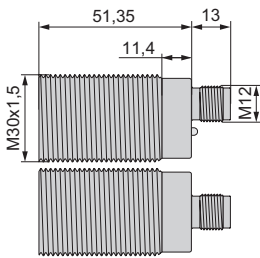

Teach pushbutton XXZPB100

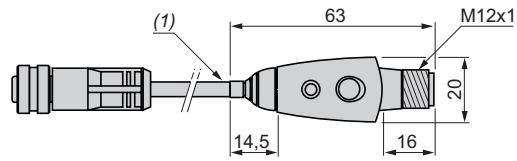

(1) Cable length: 152 mm

Connections

Connector wiring

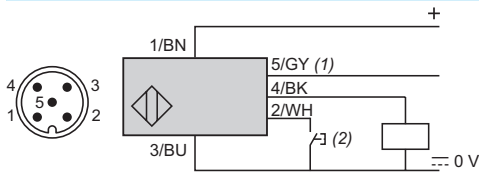

Pin number	Wire color	Digital output description	Analog output description	
			4-20 mA	0-10 V
1	BN: Brown	+12...24 V \square	+ \square 12...24 V	+ \square 14...24 V
2	WH: White	Input teach		
3	BU: Blue	0 V \square		
4	BK: Black	Output		
5	GY: Gray	Synchronization		

(1) Synchronization.

(2) External setting pushbutton or XXZPB100 remote teach pushbutton (see page 43).

Wiring scheme (digital output NO or NC)

XXA30●●PM12/XXS30●●PM12

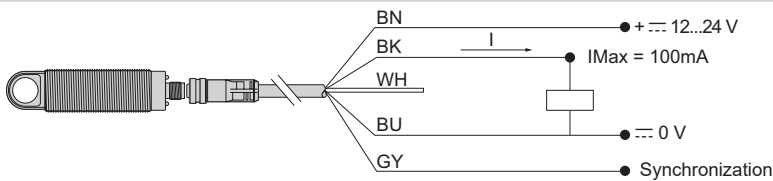

Wiring scheme (analog output 0-10V)

XX●30●●VM12

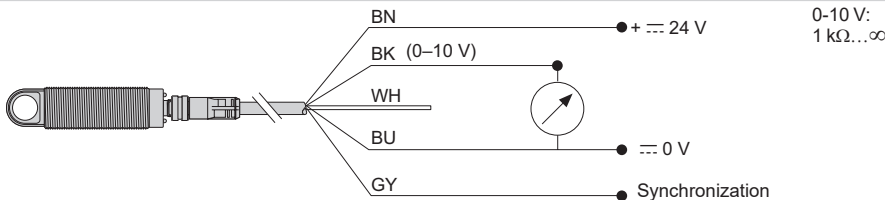

Wiring scheme (analog output 4-20 mA)

XX●30●●AM12

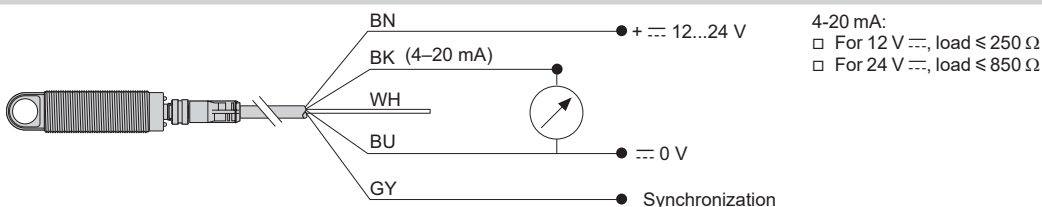

4-20 mA:
 \square For 12 V \square , load \leq 250 Ω
 \square For 24 V \square , load \leq 850 Ω

Ultrasonic sensors

XX range, General purpose

Cylindrical, plastic or metal, Ø 30 mm, 1 m sensing distance. Diffuse mode, solid-state digital or analog output. Configurable by software

Curves

Detection curve with 100 x 100 mm square target

XXA30●1●M12, XXS30B1●M12, XXS30S1●M12

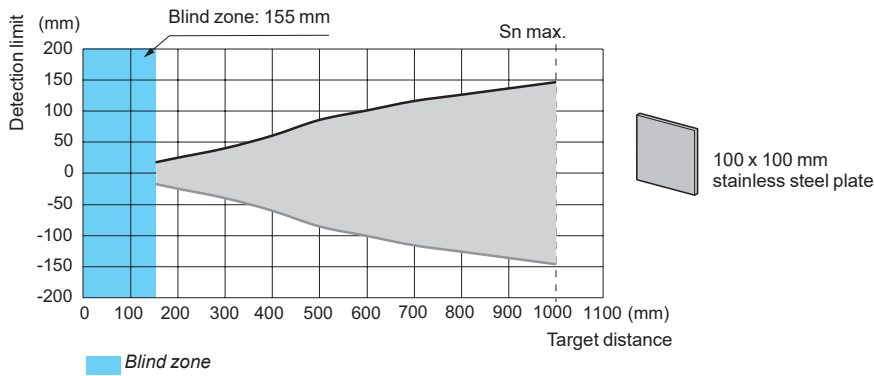

XXS30P1PM12, XXS30P1AM12, XXS30P1VM12

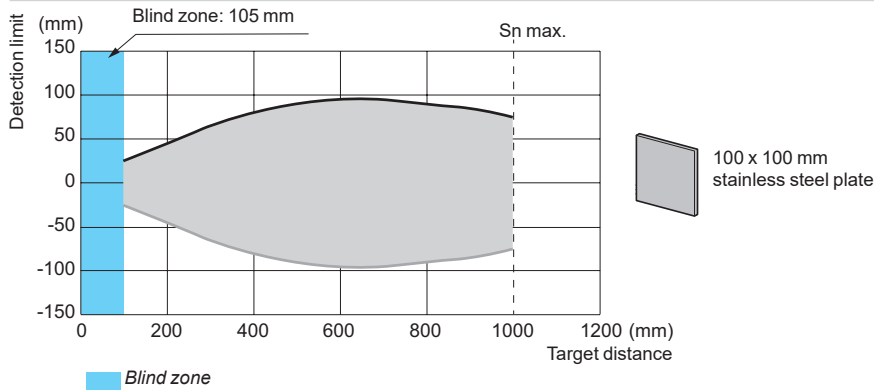

Detection curve with round bar

XXA30●1●M12, XXS30B1●M12, XXS30S1●M12

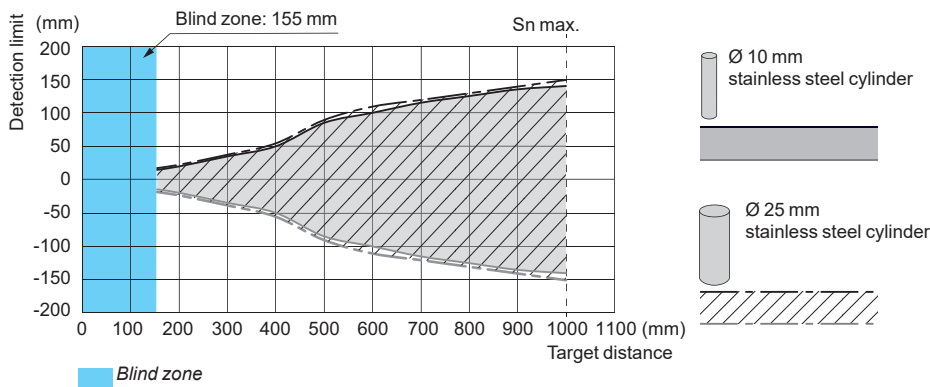

XXS30P1PM12, XXS30P1AM12, XXS30P1VM12

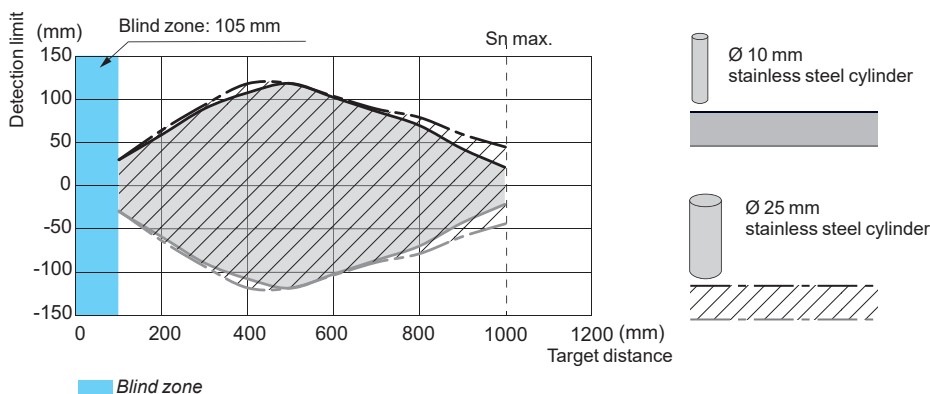

Ultrasonic sensors

XX range, General purpose
Cylindrical, plastic or metal, Ø 30 mm, 2 m sensing distance. Diffuse mode, solid-state digital or analog output. Configurable by software

Sensor type		XX●30P2PM12 XX●30B2PM12 XX●30S2PM12	XX●30P2AM12 XX●30B2AM12 XX●30S2AM12	XX●30P2VM12 XX●30B2VM12 XX●30S2VM12
General characteristics				
Conformity to standards		EN/IEC 60947-5-2, UL 508, and CSA C22.2 n°14		
Compliance with regulations		CE (based on EMC directive 2014/30/EU), NEC (ANSI/NFPA 70), CEC (CSA C22), UNECE R10		
Product certifications		cULus with class 2 power supply, E2, EAC, RCM, and ECOLAB		
Nominal sensing distance (Sn)		m	2 (adjustable)	
Blind zone (in diffuse mode the object is not detected in this zone)		m	0.155	
Detection window		Remotely adjustable or by using external teachbutton XXZPB100		
Transmission frequency (transmitter resonance)		kHz	120	
Differential travel		mm	< 10	–
Repeat accuracy (repeatability)		0.1 %		
Minimum size of object to be detected		Cylinder Ø 1 mm up to sensing distance of 1.4m		
Tilt angle with 100 x 100 mm target		± 10° at 2 m, ± 12° at 1.8 m ± 45° at 1m		
Materials		Case	XX●30P●: PBT XX●30B●: Nickel-plated brass XX●30S●: Stainless steel 316L	
		Sensing face	Epoxy, resin, and rubber	
Connection		M12 connector - 5-pin		
Supply characteristics				
Rated supply voltage (Ue) with protection against reverse polarity		V	12...24 V $\overline{\text{---}}$	12...24 V $\overline{\text{---}}$
Voltage limits (including ripple)		V	10...30 V $\overline{\text{---}}$	10...30 V $\overline{\text{---}}$
Current consumption, no-load		mA	< 65	< 65
Output characteristics				
LED indicators		Output state	Yellow LED	Yellow LED
		Echo state	Green LED	Green LED
Switching capacity (with overload and short-circuit protection)		< 100 mA		
Resistive load impedance		Ω	–	$\overline{\text{---}}$ 12 V, load ≤ 250 Ω $\overline{\text{---}}$ 24 V, load ≤ 850 Ω
Voltage drop		V	< 2	–
Internal temperature compensation		Yes		
Maximum switching frequency		Hz	5.5	–
Delays		First-up	ms	150
		Response	ms	90
		Recovery	ms	90
Environment characteristics				
Degree of protection		Conforming to IEC 60529 and EN/IEC 60947-5-2	IP 65, IP 67	
Storage temperature		°C	- 40...+ 80	
Operating temperature		°C	- 25...+ 70	
Relative humidity		< 95%, without condensation		
Vibration resistance		Conforming to IEC 60068-2-6	Amplitude ± 1 mm (f = 10...55 Hz)	
Mechanical shock resistance		Conforming to IEC 60068-2-27	30 gn, duration 11 ms, in all 3 axes	
Resistance to electromagnetic interference		Conforming to EN/IEC 60947-5-2 and UNECE R10-05		

Ultrasonic sensors

XX range, General purpose

Cylindrical, plastic or metal, Ø 30 mm, 2 m sensing distance. Diffuse mode, solid-state digital or analog output. Configurable by software

Operating diagrams for digital output sensors

Settings with teach procedure

Window mode

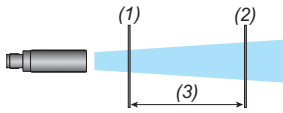

Reflex mode

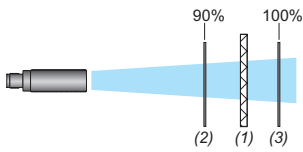

Proximity mode

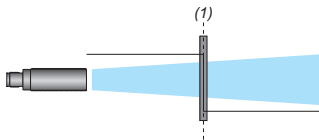

(1) Switch point

Operating diagram for analog output sensors

Near and far limits setting with teach procedure

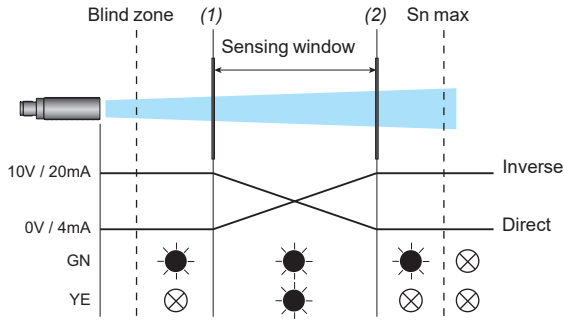

Pump/Hysteresis mode

Emptying (stored in high threshold memory)

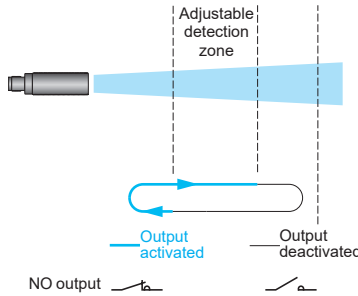

Filling (stored in low threshold memory)

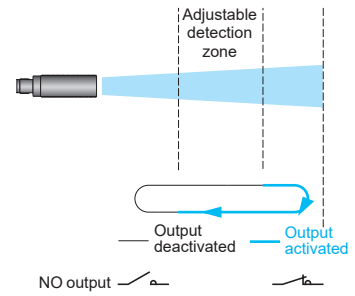

Ultrasonic sensors

XX range, General purpose

Cylindrical, plastic or metal, Ø 30 mm, 2 m sensing distance. Diffuse mode, solid-state digital or analog output. Configurable by software

Dimensions

XX●30P2PM12, XX●30B2PM12, XX●30S2PM12

XX●30P2AM12, XX●30B2AM12, XX●30S2AM12
XX●30P2VM12, XX●30B2VM12, XX●30S2VM12

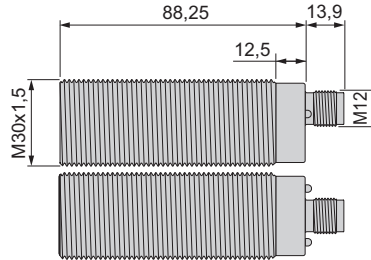
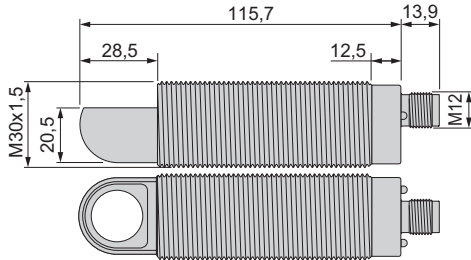

Connections

Connector wiring

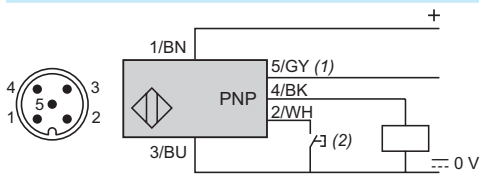

Pin number	Wire color	Digital output description	Analog output description	
			4-20 mA	0-10 V
1	BN: Brown	+12...24 V	+12...24 V	+14...24 V
2	WH: White	Input teach		
3	BU: Blue	0 V		
4	BK: Black	Output		
5	GY: Gray	Synchronization		

(1) Synchronization.

(2) External setting pushbutton or XXZPB100 remote teach pushbutton (see page 43).

Wiring scheme (digital output NO or NC)

XXS30●PM12, XXA30●PM12

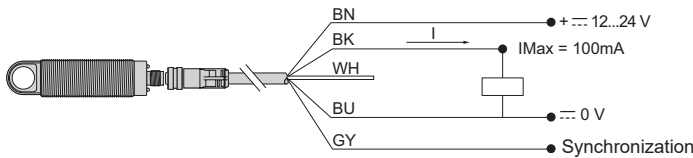

Wiring scheme (analog output 0-10V)

XX●30●VM12

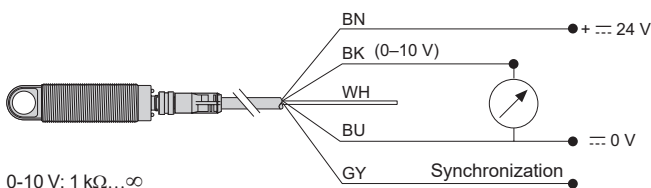

Wiring scheme (analog output 4-20 mA)

XX●30●AM12

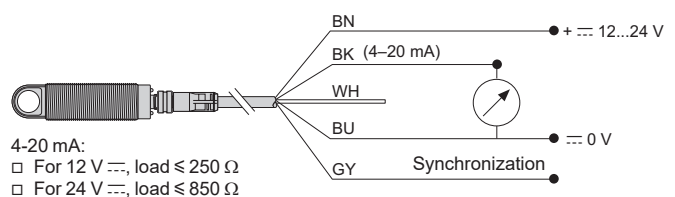
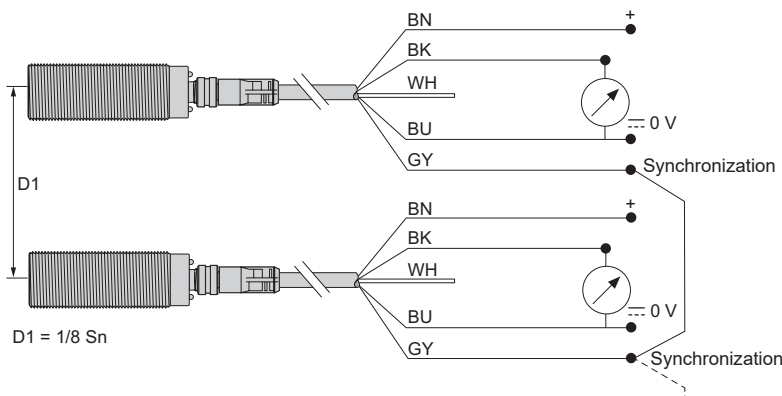

Diagram for the synchronization function (Side by side application)



NB: To enable synchronization between several sensors, all of the wires of pin no.5 (gray) must be electrically connected together. A maximum of 8 sensors can be synchronized. To enable "Multiplexer" function for the sensors, use the XX Configuration Software. Without synchronization or multiplexing, the sensors must be at least 50 cm away from each other in order to avoid mutual interference.

Ultrasonic sensors

XX range, General purpose

Cylindrical, plastic or metal, Ø 30 mm, 2 m sensing distance. Diffuse mode, solid-state digital or analog output. Configurable by software

Dimensions (continued)

Fixing clamp XXZB130

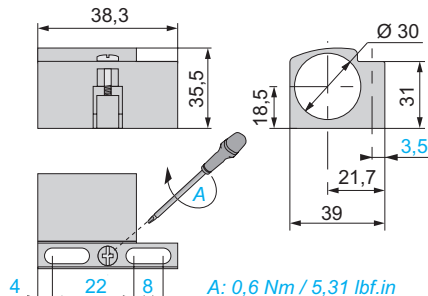

A: 0,6 Nm / 5,31 lbf.in

Teach pushbutton XXZPB100

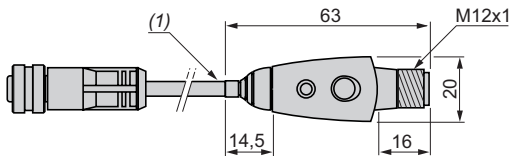

(1) Cable length: 152 mm

Curves

Detection curve with 100 x 100 mm square target

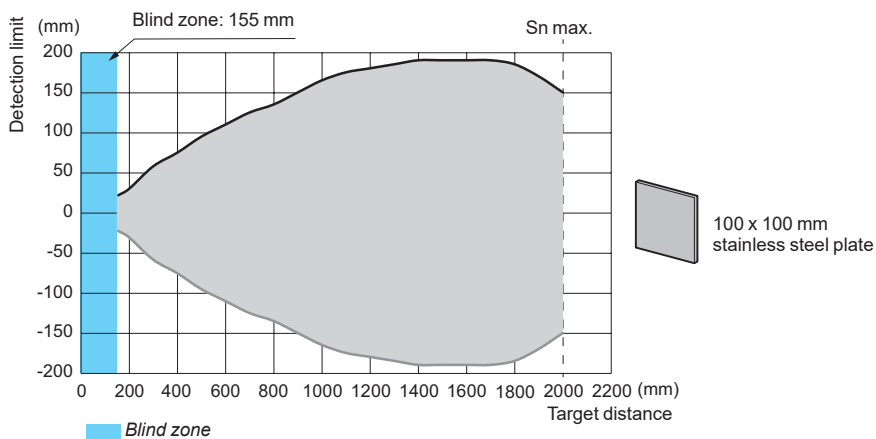

Detection curve with round bar

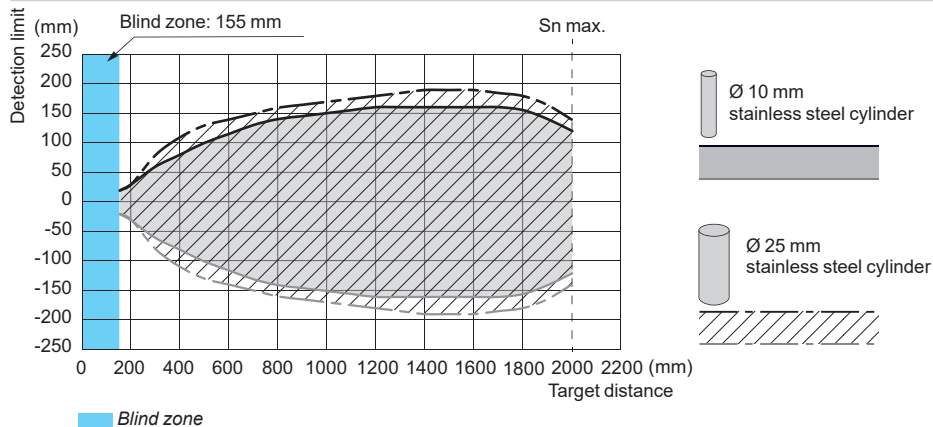

Ultrasonic sensors

XX range, General purpose
Cylindrical, plastic or metal, Ø 30 mm, 4 m sensing distance. Diffuse mode, solid-state digital or analog output. Configurable by software

Sensor type		XXS30●4PM12	XXS30●4AM12	XXS30●4VM12
General characteristics				
Conformity to standards		EN/IEC 60947-5-2, UL 508, and CSA C22.2 n°14		
Compliance with regulations		CE (based on EMC directive 2014/30/EU), NEC (ANSI/NFPA 70), CEC (CSA C22), UNECE R10		
Product certifications		cULus with class 2 power supply, E2, EAC, RCM, and ECOLAB		
Nominal sensing distance (Sn)	m	4 (adjustable)		
Blind zone (in diffuse mode the object is not detected in this zone)	m	0.420		
Detection window		Remotely adjustable or by using external teachbutton XXZPB100		
Transmission frequency (transmitter resonance)	kHz	80		
Differential travel	mm	< 20	–	
Repeat accuracy (repeatability)		0.1 %		
Minimum size of object to be detected		Cylinder Ø 1 mm up to sensing distance of 1.8m		
Tilt angle with 500 x 500 mm target		± 7° at 4 m, ± 10° at 3.6 m ± 40° at 2 m		
Materials	Case	XXS30P●: PBT XXS30B●: Nickel-plated brass XXS30S●: Stainless steel 316L		
	Sensing face	Epoxy, resin, and rubber		
Connection		M12 connector - 5-pin		
Supply characteristics				
Rated supply voltage (Ue) with protection against reverse polarity	V	12...24 V $\overline{\text{---}}$	12...24 V $\overline{\text{---}}$	24 V $\overline{\text{---}}$
Voltage limits (including ripple)	V	10...30 V $\overline{\text{---}}$	10...30 V $\overline{\text{---}}$	14...30 V $\overline{\text{---}}$
Current consumption, no-load	mA	< 65	< 65	< 65
Output characteristics				
LED indicators	Output state	Yellow LED	Yellow LED	Yellow LED
	Echo state	Green LED	Green LED	Green LED
Switching capacity (with overload and short-circuit protection)		< 100 mA	–	–
Resistive load impedance	Ω	–	12 V $\overline{\text{---}}$, load ≤ 250 Ω 24 V $\overline{\text{---}}$, load ≤ 850 Ω	≥ 1 kΩ
Voltage drop	V	< 2	–	–
Internal temperature compensation		Yes	Yes	Yes
Maximum switching frequency	Hz	2.7	–	–
Delays	First-up	ms 250	500	500
	Response	ms 180	–	–
	Recovery	ms 180	400	400
Environment characteristics				
Degree of protection	Conforming to IEC 60529 and EN/IEC 60947-5-2	IP 65, IP 67		
Storage temperature		°C -40...+80		
Operating temperature		°C -25...+70 (1)		
Relative humidity		< 95%, without condensation		
Vibration resistance	Conforming to IEC 60068-2-6	Amplitude ± 1 mm (f = 10...55 Hz)		
Mechanical shock resistance	Conforming to IEC 60068-2-27	30 gn, duration 11 ms, in all 3 axes		
Resistance to electromagnetic interference		Conforming to EN/IEC 60947-5-2 and UNECE R10-05		

Ultrasonic sensors

XX range, General purpose

Cylindrical, plastic or metal, Ø 30 mm, 4 m sensing distance. Diffuse mode, solid-state digital or analog output. Configurable by software

Operating diagrams for digital output sensors

Settings with teach procedure

Window mode

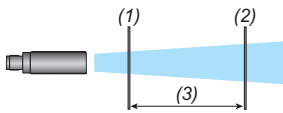

- (1): Near limit
- (2): Far limit
- (3): Sensing window

Reflex mode

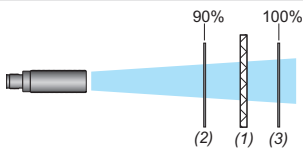

- (1): Reflector
- (2): Near limit
- (3): Far limit

Proximity mode

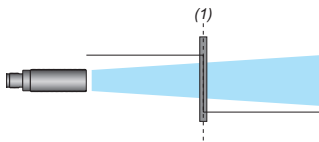

- (1): Switch point

Pump/Hysteresis mode

Emptying (stored in high threshold memory)

Filling (stored in low threshold memory)

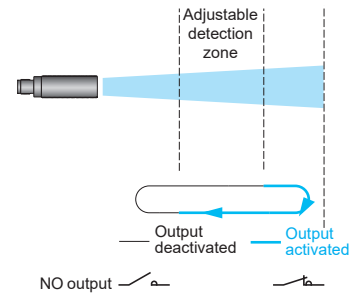
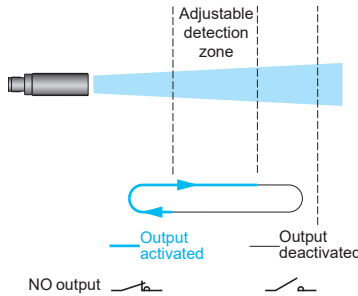

Operating diagram for analog output sensors

Near and far limits setting with teach procedure

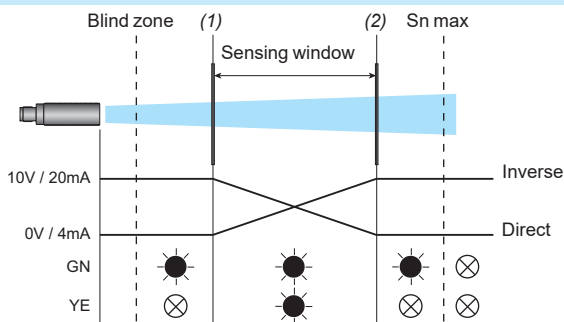

GN: Green LED
YE: Yellow LED

⊗ : OFF

● : ON

- (1): Near limit
- (2): Far limit

Ultrasonic sensors

XX range, General purpose

Cylindrical, plastic or metal, Ø 30 mm, 4 m sensing distance. Diffuse mode, solid-state digital or analog output. Configurable by software

Dimensions

XXS30P4PM12, XXS30B4PM12, XXS30S4PM12

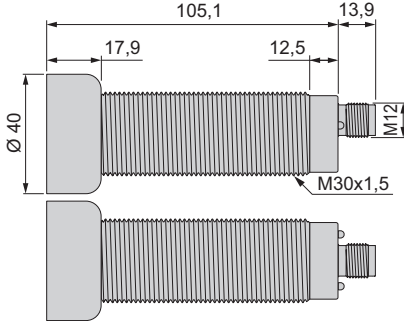

Connections

Connector wiring

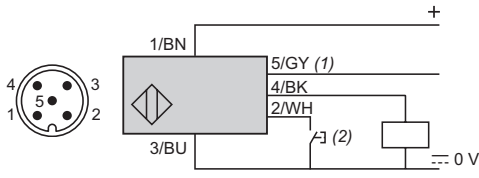

Pin number	Wire color	Digital output description	Analog output description	
			4-20 mA	0-10 V
1	BN: Brown	+12...24 V	+12...24 V	+14...24 V
2	WH: White	Input teach		
3	BU: Blue	0 V		
4	BK: Black	Output		
5	GY: Gray	Synchronization		

(1) Synchronization.

(2) External setting pushbutton or **XXZPB100** remote teach pushbutton (see page 43).

Wiring scheme (digital output NO or NC)

XXS30●●PM12

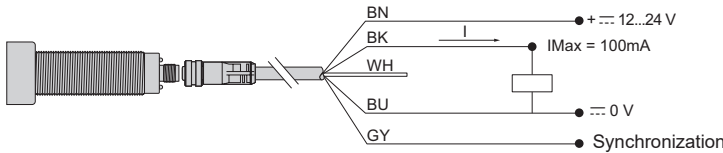

Wiring scheme (analog output 0-10V)

XX●30●●VM12

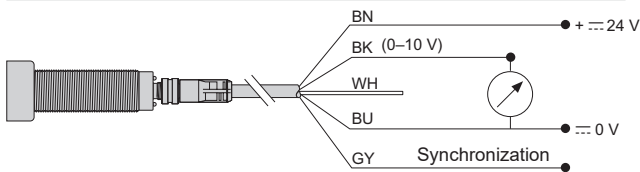

0-10 V: 1 kΩ...∞

Wiring scheme (analog output 4-20 mA)

XX●30●●AM12

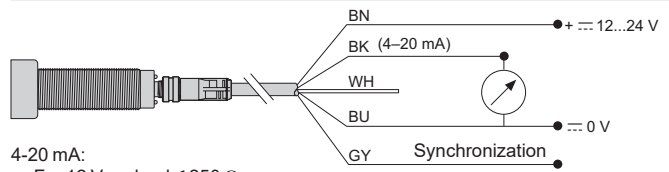

4-20 mA:
 For 12 V, load ≤ 250 Ω
 For 24 V, load ≤ 850 Ω

Diagram for the synchronization function (Side by side application)

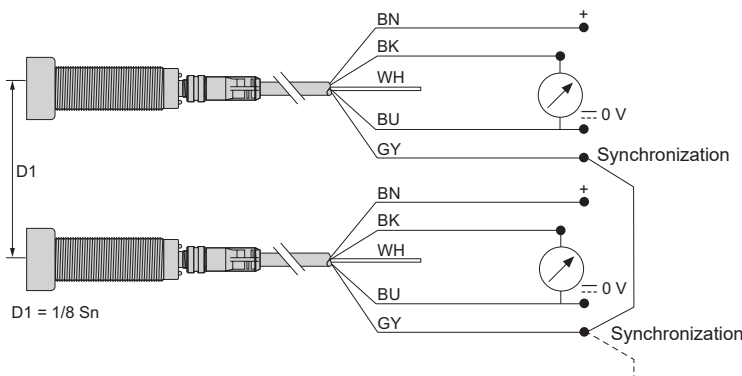

NB: To enable synchronization between several sensors, all of the wires of pin no. 5 (gray) must be electrically connected together. A maximum of 8 sensors can be synchronized. To enable "Multiplexer" function for the sensors, use the XX Configuration Software. Without synchronization or multiplexing, the sensors must be at least 50 cm away from each other in order to avoid mutual interference.

Ultrasonic sensors

XX range, General purpose

Cylindrical, plastic or metal, Ø 30 mm, 4 m sensing distance. Diffuse mode, solid-state digital or analog output. Configurable by software

Dimensions (continued)

Fixing clamp XXZB130

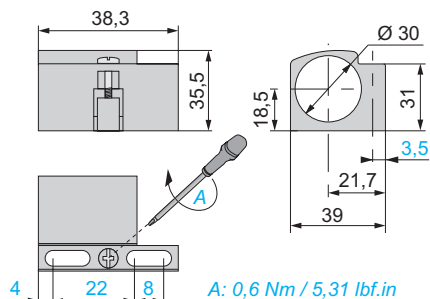

4

22 8

A: 0,6 Nm / 5,31 lbf.in

Teach pushbutton XXZPB100

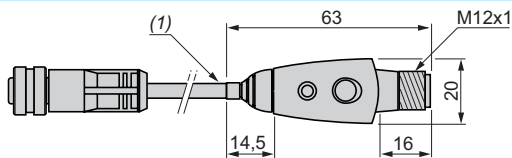

(1) Cable length: 152 mm

Curves

Detection curve with 100 x 100 mm square target

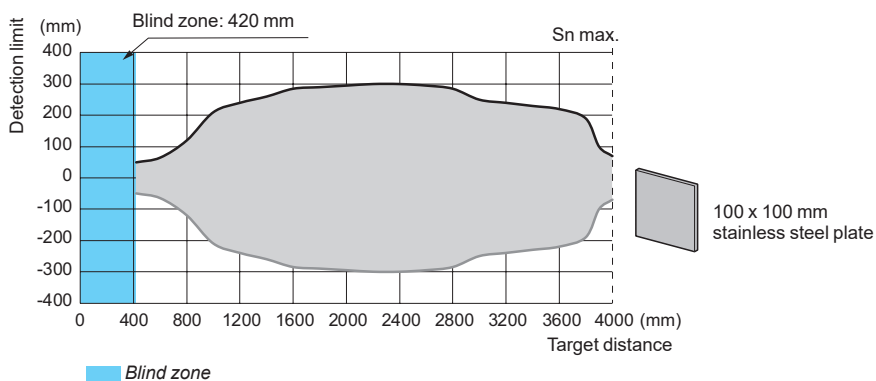

Blind zone

Detection curve with round bar

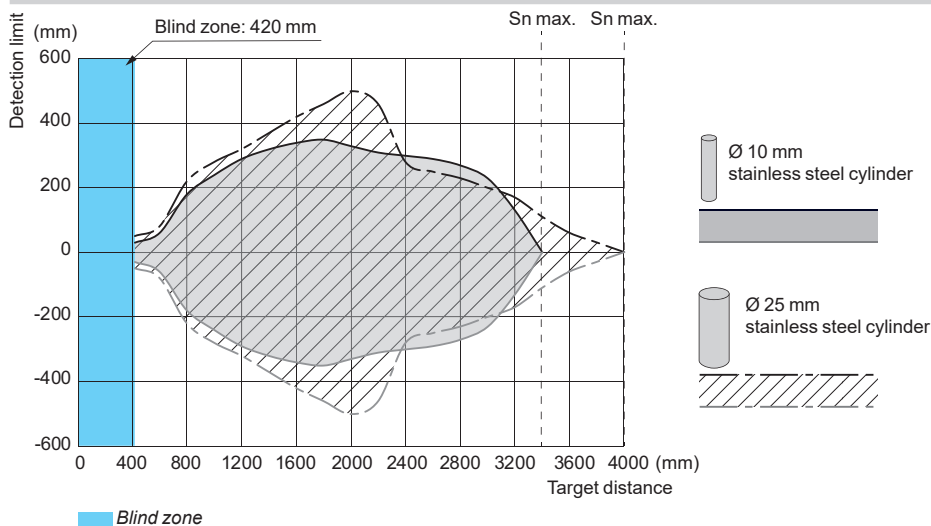

Blind zone

Ultrasonic sensors

XX range, General purpose

Cylindrical, plastic or metal, Ø 30 mm, 8 m sensing distance. Diffuse mode, solid-state digital or analog output. Configurable by software

Sensor type		XXS30P8PPM12 XXS30P8NNM12	XXS30P8APM12	XXS30P8VPM12	
General characteristics					
Conformity to standards		EN/IEC 60947-5-2, UL 508 and CSA C22.2 n° 14			
Compliance with regulations		CE (based on EMC directive 2014/30/EU), NEC (ANSI/NFPA 70), CEC (CSA C22), UNECE R10			
Product certifications		cULus with class 2 power supply, E2, EAC, RCM, and ECOLAB			
Nominal sensing distance (Sn)		m	8 (adjustable)		
Blind zone (in diffuse mode the object is not detected in this zone)		m	0.290		
Detection window		Remotely adjustable or by using external teachbutton XXZPB100			
Transmission frequency (transmitter resonance)		kHz	75		
Differential travel		mm	< 12.7	–	
Repeat accuracy (repeatability)		0.1 %			
Minimum size of object to be detected		Cylinder Ø 1 mm up to sensing distance of 1.8m			
Tilt angle with 500 x 500 mm target		± 4° at 8 m, ± 5° at 7.2 m ± 12° at 4 m			
Materials		Case	PBT		
		Sensing face	Epoxy, resin, and rubber		
Connection		M12 connector - 5-pin			
Supply characteristics					
Rated supply voltage (Ue) with protection against reverse polarity		V	≐ 12...24 V	≐ 12...24 V	≐ 24 V
Voltage limits (including ripple)		V	≐ 10...30 V	≐ 10...30 V	≐ 14...30 V
Current consumption, no-load		mA	< 50	< 50	< 50
Output characteristics					
LED indicators		Output state	1 dual colour LED (yellow/green) 1 three-colour LED (yellow/green/red)	1 dual colour LED (yellow/green) 1 three-colour LED (yellow/green/red)	1 dual colour LED (yellow/green) 1 three-colour LED (yellow/green/red)
		Echo state	Green LED	Green LED	Green LED
Switching capacity (with overload and short-circuit protection)			< 100 mA	–	–
Resistive load impedance		Ω	–	≐ 12 V, load ≤ 250 Ω ≐ 24 V, load ≤ 850 Ω	≥ 1 kΩ
Voltage drop		V	< 2	–	–
Internal temperature compensation			Yes	Yes	Yes
Maximum switching frequency		Hz	2	–	–
Delays		First-up	ms	600	600
		Response	ms	300	–
		Recovery	ms	300	500
Environment characteristics					
Degree of protection		Conforming to IEC 60529 and EN/IEC 60947-5-2	IP 65, IP 67		
Storage temperature		°C	- 40...+ 85		
Operating temperature		°C	- 25...+ 70		
Relative humidity		< 95%, without condensation			
Vibration resistance		Conforming to IEC 60068-2-6	Amplitude ± 1 mm (f = 10...55 Hz)		
Mechanical shock resistance		Conforming to IEC 60068-2-27	30 gn, duration 11 ms, in all 3 axes		
Resistance to electromagnetic interference		Conforming to EN/IEC 60947-5-2 and UNECE R10-05			

Ultrasonic sensors

XX range, General purpose

Cylindrical, plastic or metal, Ø 30 mm, 8 m sensing distance. Diffuse mode, solid-state digital or analog output. Configurable by software

Dimensions

XXS30P8PPM12, XXS30P8NNM12, XXS30P8APM12, XXS30P8VPM12

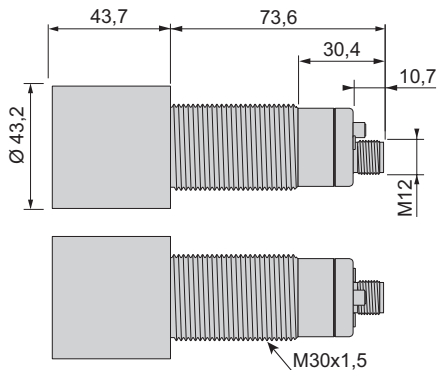

Connections

Connector wiring

XXS30P8PPM12

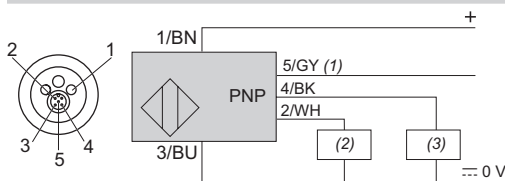

XXS30P8NNM12

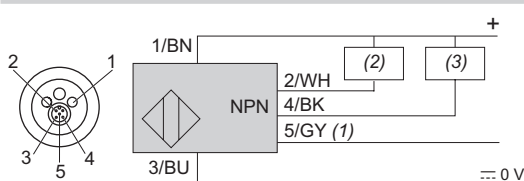

XXS30P8APM12, XXS30P8VPM12

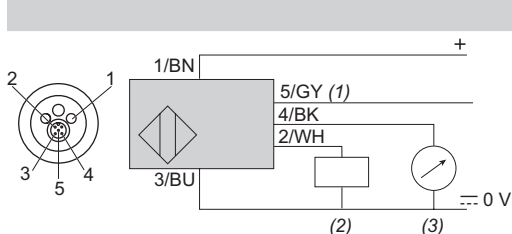

Pin number

Wire color

Digital output description

Analog output description

Pin number	Wire color	Digital output description	Analog output description	
			4-20 mA	0-10 V
1	BN: Brown	+12...24 V	+12...24 V	+24 V
2	WH: White	Output 2	PNP output	PNP output
3	BU: Blue	0 V	-	-
4	BK: Black	Output 1	4-20 mA output	0-10 V output
5	GY: Gray	Synchronization		

- (1) Synchronization
- (2) Output 2
- (3) Output 1

Wiring scheme (digital output PNP, NO or NC)

XXS30P8PPM12

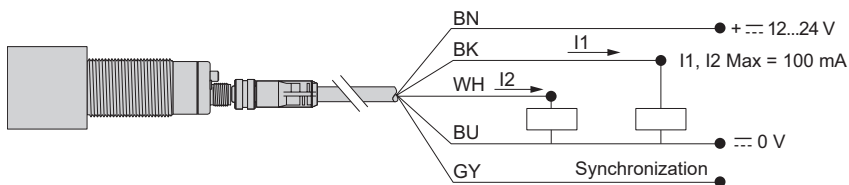

Wiring scheme (digital output NPN, NO or NC)

XXS30P8NNM12

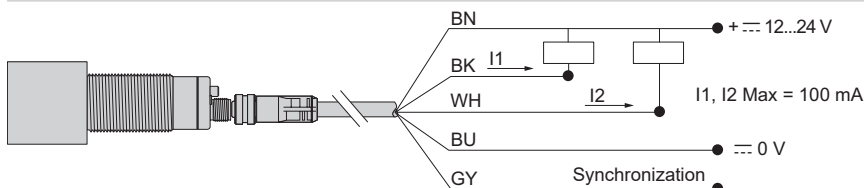

Ultrasonic sensors

XX range, General purpose

Cylindrical, plastic or metal, Ø 30 mm, 8 m sensing distance. Diffuse mode, solid-state digital or analog output. Configurable by software

Connections (continued)

Wiring scheme (analog output 0-10 V and PNP, NO or NC)

XXS30P8VPM12

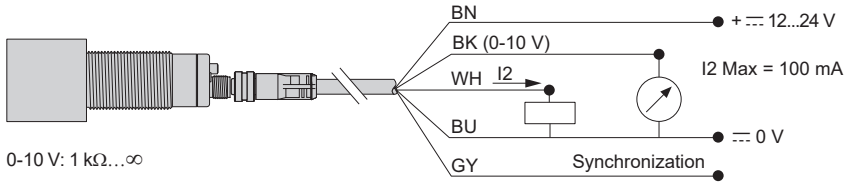

Wiring scheme (analog output 4-20 mA and PNP, NO or NC)

XXS30P8APM12

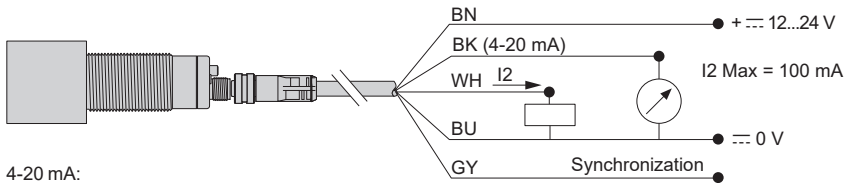

- 4-20 mA:
- For 12 V $\overline{\text{DC}}$, load $\leq 250 \Omega$
 - For 24 V $\overline{\text{DC}}$, load $\leq 850 \Omega$

Diagram for the synchronization function (Side by side application)

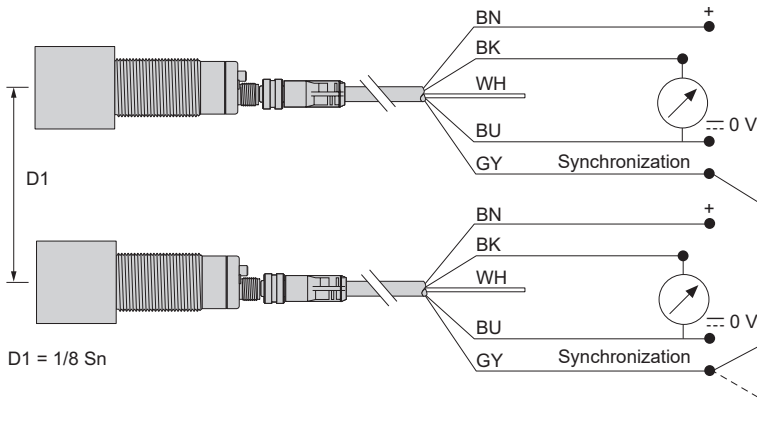

NB: To enable synchronization between several sensors, all of the wires of pin no. 5 (gray) must be electrically connected together. A maximum of 8 sensors can be synchronized. To enable "Multiplexer" function for the sensors, use the XX Configuration Software. Without synchronization or multiplexing, the sensors must be at least 50 cm away from each other in order to avoid mutual interference.

Ultrasonic sensors

XX range, General purpose

Cylindrical, plastic or metal, Ø 30 mm, 8 m sensing distance. Diffuse mode, solid-state digital or analog output. Configurable by software

Curves

Detection curve with 100 x 100 mm square target

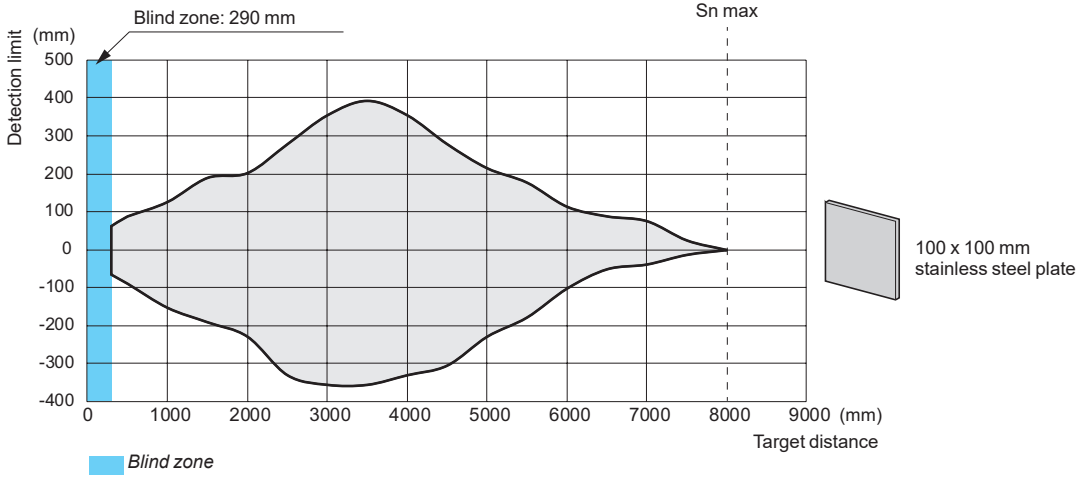

Detection curve with round bar

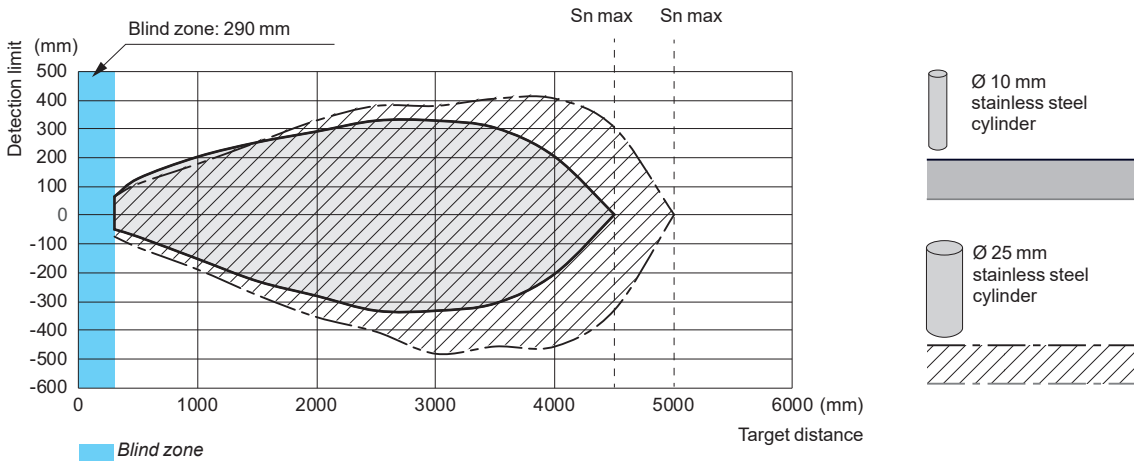

Operating diagram for analog output sensors

Near and far limits setting with teach procedure

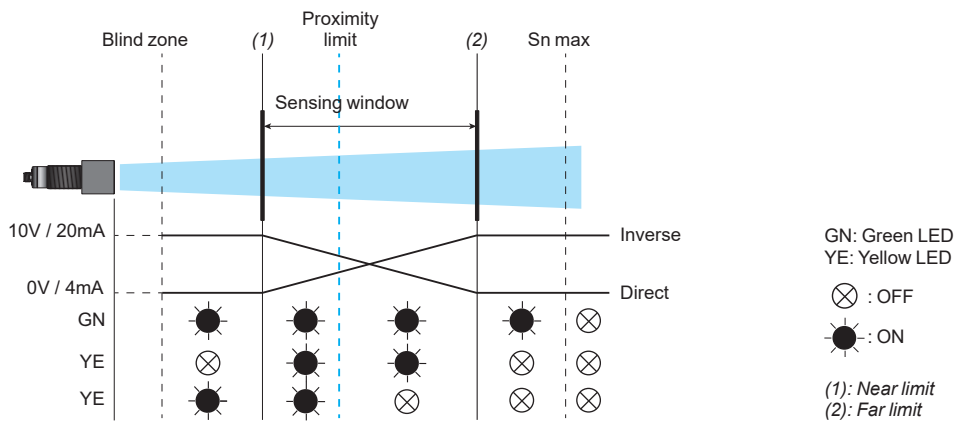

Ultrasonic sensors

XX range, Wide Beam

Obstacle detection system for mobile equipment.
Diffuse mode, solid-state digital output and analog output. Configurable by software

Wide Beam ultrasonic sensors

Telemecanique Sensors has expanded its range of ultrasonic sensors with the “XX Wide Beam” offer to meet the specific needs of mobile equipment such as:

- Lift trucks
- Cherry pickers
- Mobile elevating work platforms
- Self-propelled ride-on handling trucks
- Ground support equipment
- Aircraft access platforms, etc.



These sensors are designed to detect the following kinds of obstacles when mobile equipment is lifting or rotating:
ceilings, beams, cables, scaffolding, other platforms or buckets, etc.

Compact and flush mountable in metal, these sensors are easy to install with:

- A remote Deutsch DTM04 connector on a 0.15 m cable, or
 - A 0.5 m cable
- They operate silently and are also suitable for indoor use.

The XX configuration software makes these sensors easy to program.

The synchronization function is used to reduce interference between sensors, even when installed close to each other, thus helping to ensure objects are detected over a wide area.

Important: This device does not have a Performance Level or Safety Integrity Level or any other type of capability with regard to functional safety.

For safety applications, visit our website: www.tesensors.com

Obstacle detection system

- > **Wide detection area:** Fewer sensors are needed to cover a given area.
- > Better tilt angle for enhanced detection of targets and surfaces, even those that are slightly reflective or curved
- > **Rugged sensors suitable for use in harsh environments**
- > Operation in temperatures as low as -40 °C with no adverse impact on detection capability
- > Thermoplastic UV-resistant front face that can tolerate potential damage caused by building materials or bad weather
- > IP69K rating for high-pressure washdown
- > **Noise detection capability to assist the user**
- > The sensor is equipped with a noise detection function that is enabled by default. When noise detection is enabled, the sensor’s analog output emits 2 mA or 5 volts (depending on model) when it detects excessive environmental noise.
- > Noise detection settings can be changed using the configuration interface and software (see page 74).

Compact solution for detecting obstacles



Certified

- > E2 according to UN Regulation 10R-06
- > cULus

Ultrasonic sensors

XX range, Wide Beam

Obstacle detection system for mobile equipment.
Diffuse mode, solid-state digital output and analog output. Configurable by software



XXW54P3•PL01DM6



XXW54P3•PL05



XXZKITDM6

References

Diffuse sensors with 0.5...4.5 V analog output and solid state digital output

Description	Sensing distance (Sn)	Function/ output	Connections	Reference	Weight
					kg
Ø 54 mm plastic sensor	3	0.5...4.5 V + PNP	0.15 m cable with remote Deutsch DTM04 6-pin connector	XXW54P3HPL01DM6	0.115
			0.5 m cable		XXW54P3HPL05

Diffuse sensors with 4...20 mA analog output and solid state digital output

Ø 54 mm plastic sensor	3	4...20 mA + PNP	0.15 m cable with remote Deutsch DTM04 6-pin connector	XXW54P3APL01DM6	0.115
			0.5 m cable		XXW54P3APL05

Connection accessory

Configuration cable for sensors XXW54P3•PL01DM6	1 m cable with female Deutsch DTM04 6-pin connector and male M12 5-pin connector	XXZKITDM6	0.050
---	--	-----------	-------

Configuration software, interface, and kit for synchronization function

See page 74.

Ultrasonic sensors

XX range, Wide Beam

Obstacle detection system for mobile equipment.
Diffuse mode, solid-state digital output and analog output. Configurable by software

Sensor type	XXW54P3HPL01DM6	XXW54P3APL01DM6	XXW54P3HPL05	XXW54P3APL05
General characteristics				
Conforming to standards	EN/IEC 60947-5-2, UL 60947-5-2 and CSA C22.2 n° 60947-5-2			
Compliance with regulations	CE (based on the EMC directive 2014/30/UE), NEC (ANSI/NFPA 70), CEC (CSA C22), UNECE R10			
Product certifications	UKCA, E2 (pending), cULus			
Nominal sensing distance (Sn)	m	0.425...3		
Blind zone	mm	425		
Detection window	Adjustable using XX configuration software, up to 4 m			
Transmission frequency (transmitter resonance)	kHz	48		
Differential travel	mm	< 20		
Repeat accuracy	0.1 %			
Sensor accuracy	2 %			
Minimum size of object to be detected	Cylinder Ø 10 mm up to a sensing distance of 3 m			
Tilt angle with 500 x 500 mm target	± 6° at 4 m, ± 10° at 3 m, ± 45° at 1.5 m			
Materials	Casing	PBT (Valox), UV resistant		
	Sensing face	PEI (ULTEM) with PUR coating, UV resistant		
Fixing method	Using 2 M4 screws (not provided). 2 x Ø 4.32 mm stainless steel inserts and silicone washers are provided with the sensor. Tightening torque ≤ 3 Nm (26.6 lb-in)			
Connection	By remote Deutsch DTM04 6-pin connector, on 0.15 m Ø 6 mm TPU cable		By 0.5 m Ø 6 mm TPU cable CSA: 5 x 0.34 mm ²	

Power supply characteristics					
Rated supply voltage (Ue) with protection against reverse polarity	V	12...24 V $\overline{\text{---}}$. Powered by a dedicated safety extra low voltage (SELV) or a protected extra low voltage (PELV)			
Voltage limits (including ripple)	V	$\overline{\text{---}}$ 9...32			
Current consumption, no-load	mA	< 30	< 50	< 30	< 50

Output characteristics					
Indicator lights	Output status	1 yellow LED			
	Power supply and echo status	1 two-tone LED (white and green). White: power on; green: echo status			
Switching capacity	mA	< 100 (with overload and short-circuit protection)			
Resistive load impedance		≥ 2 K Ω	≤ 250 Ω (12 V), ≤ 850 Ω (24 V)	≥ 2 K Ω	≤ 250 Ω (12 V), ≤ 850 Ω (24 V)
Voltage drop	V	< 2			
Internal temperature compensation	Yes				
Maximum switching frequency	Hz	1.6			
Delays	First-up	ms	400		
	Response	ms	300		
	Recovery	ms	300		

Environmental characteristics				
Degree of protection	Conforming to IEC 60529 and EN/IEC 60947-5-2	IP 65, IP 67, IP 69K		
Storage temperature	°C	-40...+ 85		
Operating temperature	°C	-40...+ 70		
Relative humidity	< 95%, non-condensing			
Vibration resistance	Conforming to IEC 60068-2-6	Amplitude ± 1 mm (f = 10...55 Hz)		
Mechanical shock resistance	Conforming to IEC 60068-2-27	30 gn, duration 11 ms, in all 3 axes		
Immunity to electromagnetic interference	Conforming to EN/IEC 60947-5-2			

Setting-up precautions

Flush-mounting recommendations

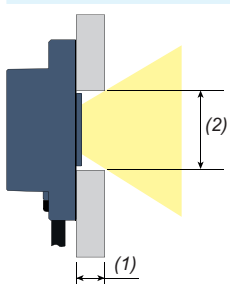

- (1) Max. thickness = 10 mm
(2) Minimum Ø = 33 mm

Mounting with inserts and washers

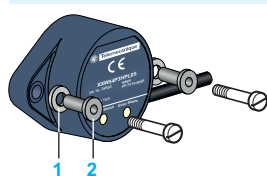

- 1 Silicone washer
2 Stainless steel insert

Mutual interference between two separate pieces of mobile equipment, side by side

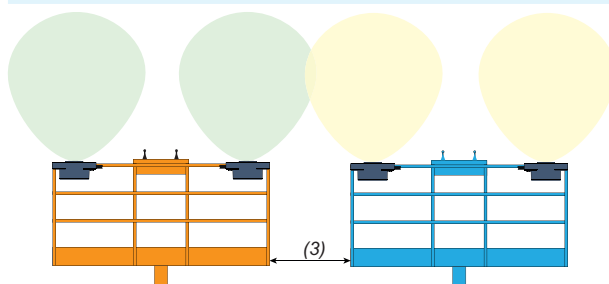

- (3) Minimum distance: 2.5 m
Note: Sensors in the same mobile equipment must be synchronized, but sensors in two separate pieces of mobile equipment cannot be synchronized.

Ultrasonic sensors

XX range, Wide Beam

Obstacle detection system for mobile equipment.
Diffuse mode, solid-state digital output and analog
output. Configurable by software

Dimensions

XXW54P3HPL01DM6, XXW54P3APL01DM6

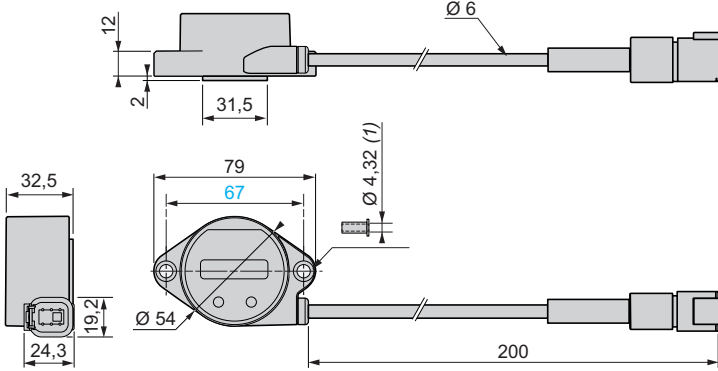

(1) The sensor is supplied with 2 stainless steel inserts
Ø 4.32 mm and 2 silicone washers.
M4 screws not provided

XXW54P3HPL05, XXW54P3APL05

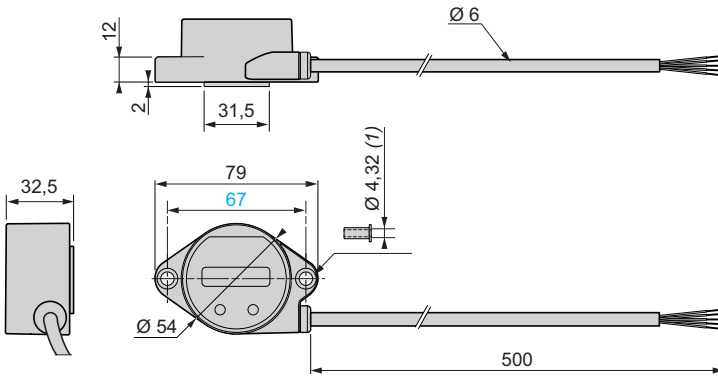

(1) The sensor is supplied with 2 stainless steel inserts
Ø 4.32 mm and 2 silicone washers.
M4 screws not provided

Connections

Connector wiring

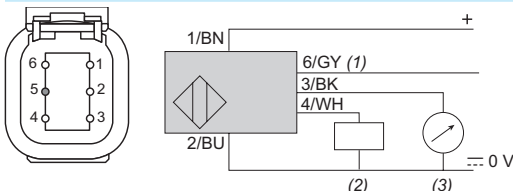

Pin number	Wire color	Description	
		XXW54P3HPL01DM6	XXW54P3APL01DM6
1	BN: Brown	+12...24 V $\overline{\text{---}}$	+ 12...24 V $\overline{\text{---}}$
2	BU: Blue	0 V $\overline{\text{---}}$	0 V $\overline{\text{---}}$
3	BK: Black	0.5...4.5 V analog output (5)	4...20 mA analog output (6)
4	WH: White	PNP solid-state output	PNP solid-state output
5 (4)	—	Not connected	Not connected
6	GY: Gray	Synchronization	Synchronization

(1) Synchronization

(2) Output 2

(3) Output 1

(4) Contact not connected, equipped with a sealing plug.

(5) The sensor's analog output emits 5 volts when it detects excessive environmental noise.

(6) The sensor's analog output emits 2 mA when it detects excessive environmental noise.

Wiring diagrams

XXW54P3HPL05

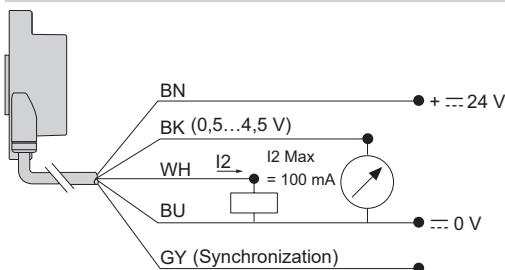

0.5...4.5 V: load 2 k Ω ... ∞

XXW54P3APL05

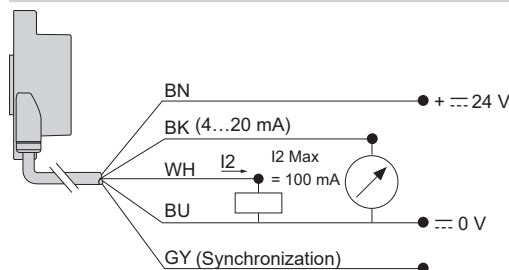

4...20 mA: load \leq 250 Ω ($\overline{\text{---}}$ 12 V), load \leq 850 Ω ($\overline{\text{---}}$ 24 V).

Ultrasonic sensors

XX range, Wide Beam

Obstacle detection system for mobile equipment.
Diffuse mode, solid-state digital output and analog output. Configurable by software

Connections (continued)

Synchronization function diagram (side-by-side application)

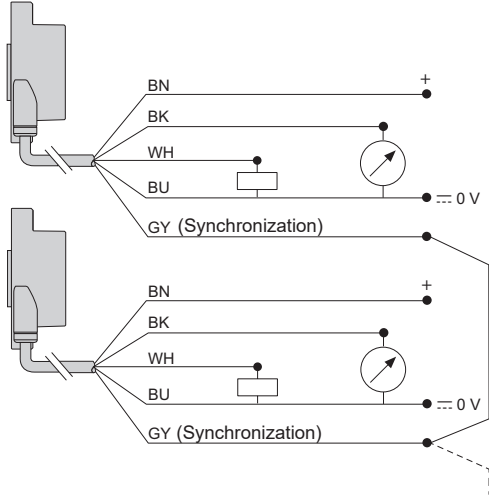

Note: Synchronization is recommended if more than one sensor is used in the same direction in order to avoid any interference between sensors due to the width of their beam. Up to 8 sensors can be synchronized to operate side by side by electrically connecting all pin no. 6 (gray) wires together. All sensors must be the same model and have the same cycle time setting.

Curves

Detection curve with 100 x 100 mm square target

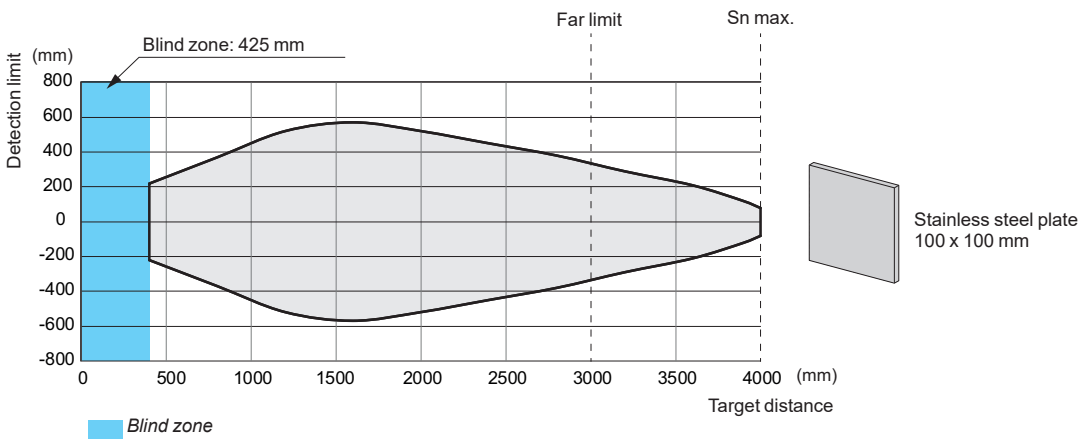

Detection curve with round bar

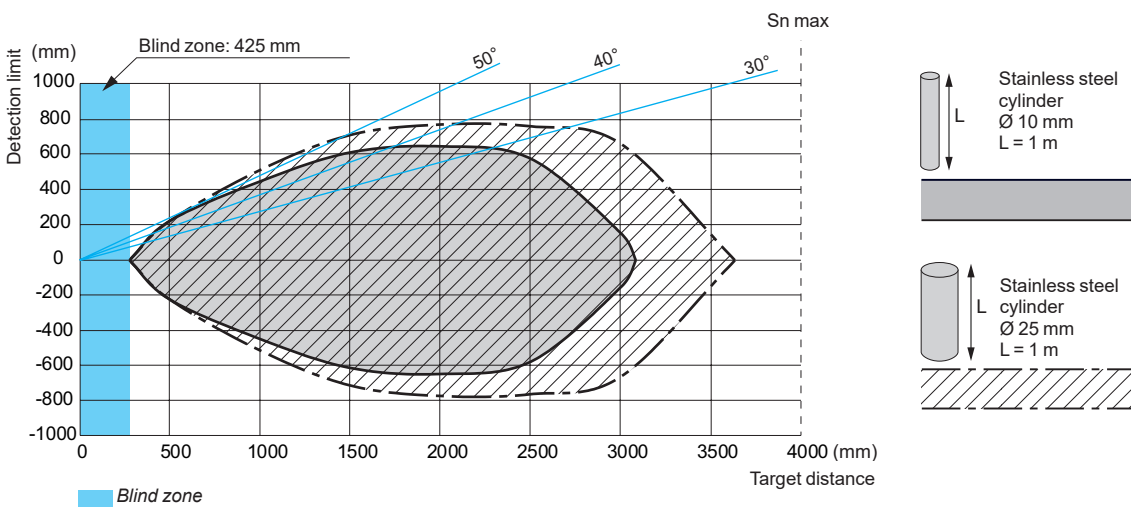

Ultrasonic sensors

XX range, Wide Beam

Obstacle detection system for mobile equipment.
Diffuse mode, solid-state digital output and analog output. Configurable by software

Operating diagram

Setting the near and far limits using the configuration software

XXW54P3HPL01DM6, XXW54P3HPL05

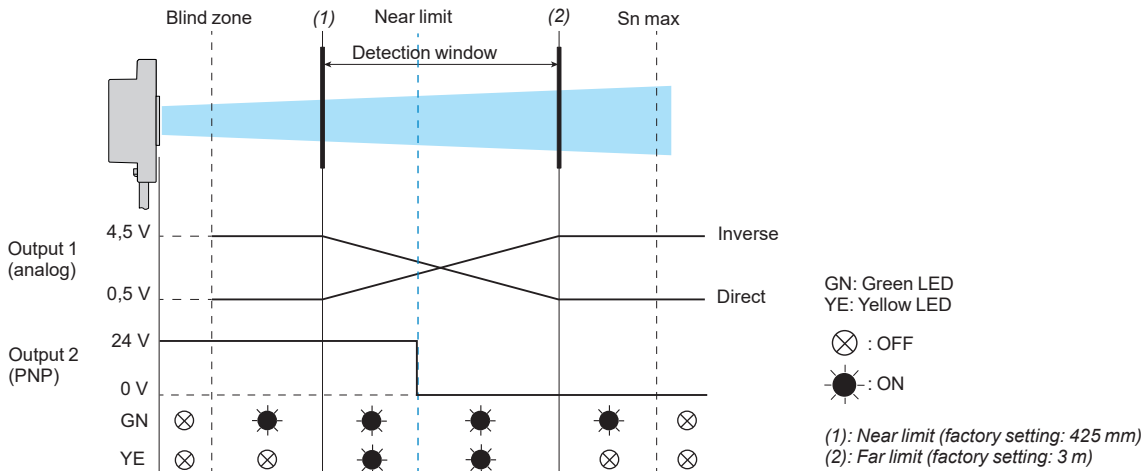

Note: The sensor's analog output emits 5 volts when it detects excessive environmental noise.

XXW54P3APL01DM6, XXW54P3APL05

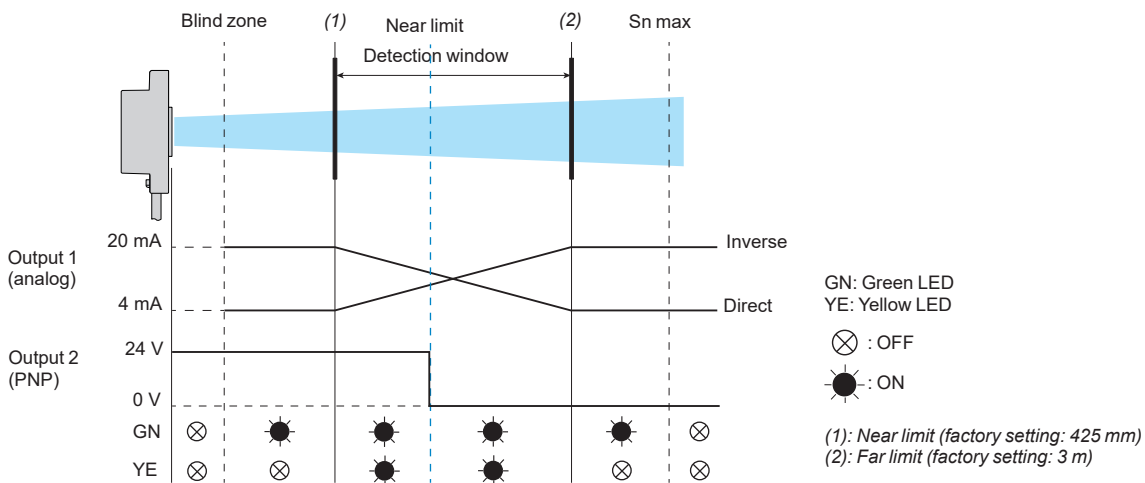

Note: The sensor's analog output emits 2 mA when it detects excessive environmental noise.

Ultrasonic sensors

XX range

Flat format, plastic

DC supply, solid-state digital output



XX7F1A2NAL01M12



XX7K1A2PAM12



XX8D1A1NAM12



XXZPB100

Diffuse mode

Fixed sensing distance sensors

Sensors	Sensing distance (Sn)	Function/output	Connection	Reference	Weight
mm	m				kg
7.6 x 19 x 33	0.10	NO/NPN	152 mm flying lead + M12 connector	XX7F1A2NAL01M12	0.040
		NO/PNP	152 mm flying lead + M12 connector	XX7F1A2PAL01M12	0.040
16 x 30 x 74	0.25	NO/PNP	M12 connector	XX7K1A2PAM12	0.050

Adjustable sensing distance sensors

18 x 33 x 60 + Ø 18	0.50 (adjustable)	NO/NPN	Connecteur M12	XX7V1A1NAM12	0.060
		NO/PNP	Connecteur M12	XX7V1A1PAM12	0.060
80 x 80 x 34	1 (adjustable)	NO/NPN	Connecteur M12	XX8D1A1NAM12	0.300
		NO/PNP	Connecteur M12	XX8D1A1PAM12	0.300

Accessories

Teach pushbutton

Description	For use with sensor	Reference	Weight kg
Selection of detection window Length of cable: 152 mm Input: M12 female connector Output: M12 male connector	XX7V1A1●AM12 XX8D1A1●AM12	XXZPB100	0.035

Other connection and fixing accessories

See page 78.

Ultrasonic sensors

XX range

Flat format, plastic

Sensors with analogue output signal 0...10 V
or 4-20 mA



XX9V1A1C2M12



XX9D1A1●●M12



XXZPB100

Diffuse mode

Adjustable sensing distance sensors

Sensors	Sensing distance (Sn)	Analogue output (Slope selection using teach button)	Reference	Weight
mm	m			kg
18 x 33 x 65 + Ø 18	0.50 (adjustable)	4-20 mA	XX9V1A1C2M12	0.090
		0-10 V	XX9V1A1F1M12	0.060
80 x 80 x 34	1 (adjustable)	4-20 mA	XX9D1A1C2M12	0.300
		0-10 V	XX9D1A1F1M12	0.300

Accessories

Teach pushbutton

Description	For use with sensors	Reference	Weight
Selection of detection window Length of cable: 152 mm Input: M12 female connector Output: M12 male connector	XX9V1A1●●M12 XX9D1A1●●M12	XXZPB100	0.035

Other connection and fixing accessories

See page 78.

Ultrasonic sensors

XX range

Flat format, plastic

Sensor type	XX7F1A2●	XX7K1A2●	XX7V1A1●	XX8D1A1●	XX9V1A1●	XX9D1A1●	
General characteristics							
Conformity to standards	CE, IEC 60947-5-2						
Product certifications	UL	UL	UL	UL	UL, cCSAus		
Nominal sensing distance (Sn)	m	0.1	0.25	0.5	1	0.5	1
Blind zone (in diffuse mode the object is not detected in this zone, in reflex mode the background is not detected in this zone)	mm	0...6.4	0...51	0... 51	0... 100	0...51	0...100
Detection window		Fixed		Remotely adjustable or by using teach button			
Detection system	Diffuse mode	●	●	●	●	●	●
Transmission frequency	kHz	500	500	300	180	300	180
Differential travel	mm	< 0.7	< 0.35	< 2.5	< 2.5	–	–
Repeat accuracy	mm	± 0.7	± 0.7	± 1.27	± 1.6	1.27	± 1.6
Overall beam angle (see detection lobe)		14°	14°	12°	7°	6°	7°
Minimum size of object to be detected		Cylinder Ø 2.5 mm or flat bar 1 mm wide up to 50 mm	Cylinder Ø 1.6 mm up to 76 mm	Cylinder Ø 2.5 mm or flat bar 1 mm wide for a sensing distance of 150 mm	Cylinder Ø 50 mm up to 1 m	Cylinder Ø 2.5 mm or flat bar 1 mm wide for a sensing distance of 150 mm	Cylinder Ø 50 mm up to a sensing distance of 1 m
Deviation angle from 90° of the object to be detected		–				± 7°	± 5°
Materials	Case	ULTEM®		Valox®			
	Sensing face (1)	Epoxy	Silicone	Epoxy			
Connection	Connector	M12, 4-pin, on 152 mm flying lead	M12, 4-pin				
Supply characteristics							
Rated supply voltage	V	≐ 12...24 V				≐ 15...24 V	
Voltage limits (including ripple)	V	≐ 10...28 V					
Current consumption, no-load	mA	25	60	40	70	40	70

(1) Silicone face for optimum chemical resistance.

Sensor type		XX7F1A2●	XX7K1A2●	XX7V1A1●	XX8D1A1●	XX9V1A1●	XX9D1A1●	
Output characteristics								
Slope type		Direct or inverse by using teach button (see page 68).						
LED indicators	Output state	Yellow LED						
	Power on	Green LED			Green LED			
	Setting-up assistance	–			Multicolour LED		Dual colour LED	
Delays	First-up	ms	–			100	75	
Recovery time		ms	–			150	180	
Resistive load impedance	4-20 mA	Ω	–			10...500	10...350	
	0-10 V	Ω	–			1 k...∞	2 k fixed	
Switching capacity	(PNP and NPN)	mA	< 100, NO or NC function				100	
Voltage drop	(PNP and NPN)	V	< 1	< 1	< 1	< 1		
Maximum switching frequency		Hz	100	80	40	72		
Delays	First-up	ms	20	350	100	75		
	Response	ms	4	5	10	15		
	Recovery	ms	4	5	10	75		
Environment characteristics								
Degree of protection	Conforming to IEC 60529 and IEC 60947-5-2		IP 67					
Storage temperature		°C	- 40...+ 80					
Operating temperature		°C	- 20...+ 65	0...+ 50	- 20...+ 65	0...+ 70	- 20...+ 65	0...+ 70
Vibration resistance	Conforming to IEC 60068-2-6		Amplitude ± 1 mm (f = 10...55 Hz)					
Mechanical shock resistance	Conforming to IEC 60068-2-27		30 gn, duration 11 ms, in all 3 axes					
Resistance to electromagnetic interference			Conforming to IEC 60947-5-2					

Dimensions

XX7F1A2NAL01M12, XX7F1A2PAL01M12

XX7K1A2PAM12

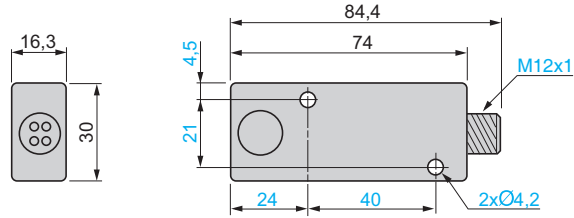
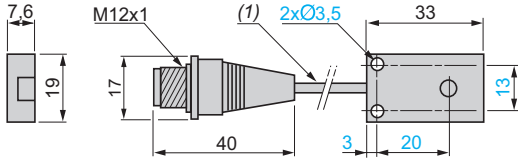

(1) Cable, length: 152 mm.

XX7V1A1NAM12, XX7V1A1PAM12

XX9V1A1C2M12, XX9V1A1F1M12

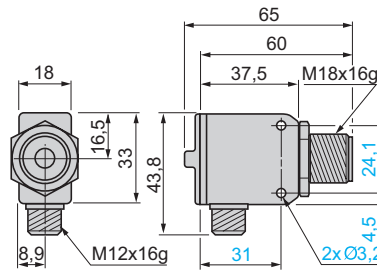
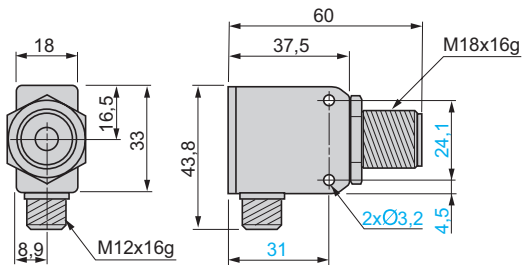

XX8D1A1NAM12, XX8D1A1PAM12, XX9D1A1C2AM12, XX9D1A1F1AM12

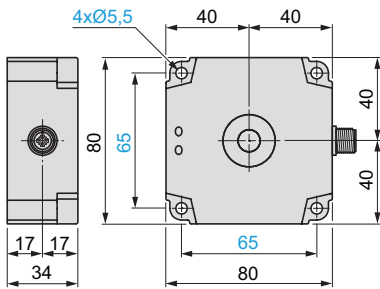

XXZPB100

Teach pushbutton

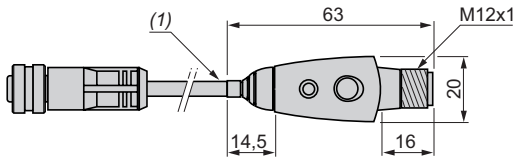

(1) Cable, length: 152 mm.

Setting-up precautions

Minimum mounting distances

Diffuse sensors, flat format

Side by side

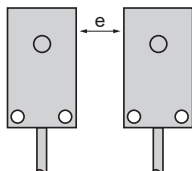

e: respect the distances indicated on the detection curves

Curves

XX7F1A2NAL01M12,
XX7F1A2PAL01M12

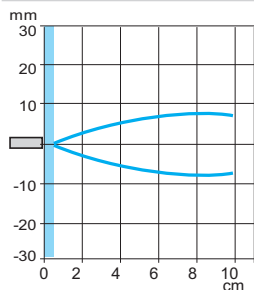

XX7K1A2PAM12

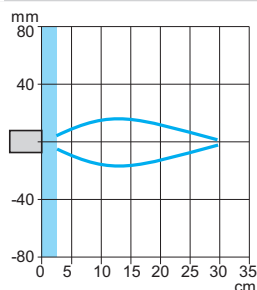

XX7V1A1NAM12, XX7V1A1PAM12,
XX9V1A1C2M12, XX9V1A1F1M12

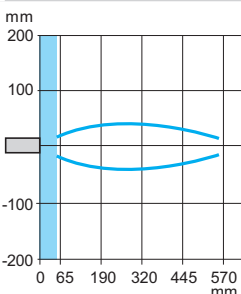

XX8D1A1NAM12, XX8D1A1PAM12,
XX9D1A1C2AM12, XX9D1A1F1AM12

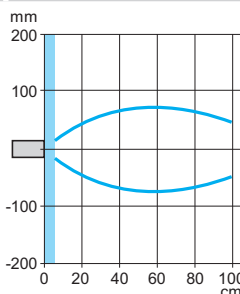

Blind zone

Schemes

M12 connector, solid-state digital output

3-wire type

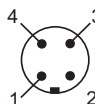

1 (+)
3 (-)
4 NPN or PNP output

XX7F1A2NAL01M12 (1)

NO outputs, NPN

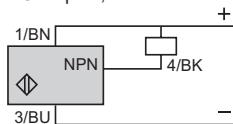

XX7F1A2PAL01M12 (1), XX7K1A2PAM12

NO outputs, PNP

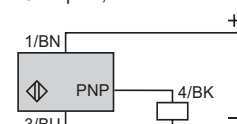

(-) BU (Blue)
(+) BN (Brown)
BK (Black)

(1) Remote connector on flying lead approximately 15 cm long.

M12 connector, analogue output

4-wire type

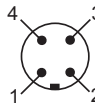

1 (+)
2 Return signal or teach
3 (-)
4 Output signal

XX7V1A1NAM12
XX8D1A1NAM12

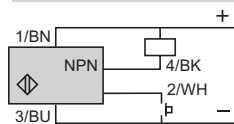

XX7V1A1PAM12
XX8D1A1PAM12

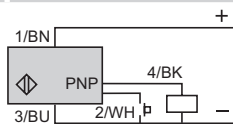

XX9V1A1C2M12, XX9V1A1F1M12, XX9D1A1C2AM12,
XX9D1A1F1AM12

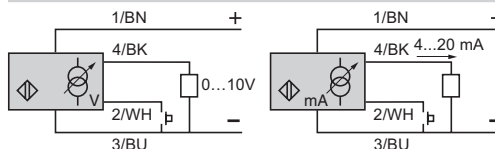

For impedance of resistive load refer to values on page 71.

XX Configuration Software

Telemecanique Sensors is now offering a solution for configuring ultrasonic XX range sensors. This software enables users to quickly find the optimal sensing solution for their applications. An interface unit connects the sensor to the PC via a USB connection.

> Easy configuration to unique applications

The configuration software has more than 20 parameters that can be modified to suit the machine application. The parameters can be saved in PDF format for quick, easy reference.

> Real-time sensor performance display

One of the best functions of the new software is the ability to troubleshoot and visualize the effects of the parameters on the configured sensor. The "echo display" function shows the exact position of any false echoes. The recording function can record the values of the echoes in an .xlsx or .xml file for extended periods of time.

> Quick duplication of programmed settings

Optimal parameters set on one sensor can be saved and loaded on other units of the same reference. This function reduces time and effort.

> The interface can be used to configure specific configurable models of XX ultrasonic sensors (XXS●●, XXA●● & XXW54P3HPL●●).

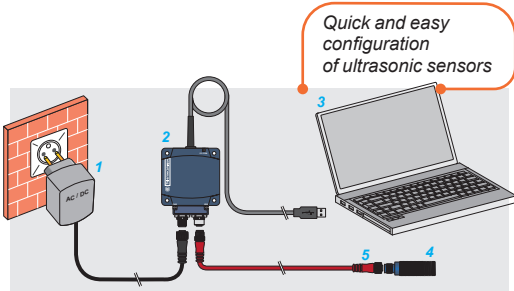

- 1: Power supply, provided with 4 adapters
- 2: Configuration interface **XXZBOX01**
- 3: XX Configuration Software, installed on a PC
- 4: Ultrasonic sensor **XXS●●**, **XXA●●** or **XXW54P3HPL●●**.
- 5: M12-M12 cable or Deutsch DTM04-M12.

XX Configuration Software for ultrasonic sensors

> XX Configuration Software is available in English, French, German, Spanish, Italian, and Chinese. It can be installed using the setup file in the USB key provided with the configuration kit or downloaded directly from the website www.tesensors.com.

> Recommended PC performance:

- > Windows OS: 7 SP1 embedded standard(x86 & x64), 8.1 (x86 & x64), or 10 (x86 & x64)
- > Internet Explorer: 9.0 or higher
- > Disk space: 1 GB or higher
- > RAM memory: 2 GB or higher
- > Processor speed: 1 GHz or higher
- > Display resolution: 1360 x 768 or higher



Ultrasonic sensors configuration interface
XXZBOX01



Ultrasonic sensors configuration kit
XXZKIT01

References

Description	Reference	Weight kg
Ultrasonic sensors configuration interface		
Configuration interface provided with: 1 power supply (1) 1 UK adapter 1 SAA adapter 1 US adapter 1 EU adapter	XXZBOX01	0.400
Ultrasonic sensors configuration kit		
Plastic case including: 1 configuration interface XXZBOX01 1 power supply (1) 1 UK adapter 1 SAA adapter 1 US adapter 1 EU adapter 1 cable of 1 m, with M12 connectors (5-pin male/female) 1 USB Flash Drive/USB key, including: the setup file for XX Configuration Software, ReadMe file, instruction sheet, tutorial, and the XX range catalogue.	XXZKIT01	1.200

(1) Power supply: 24 V $\overline{-}$, 0.5 A min., with M12 connector.

Configuration software presentation

Principle



- 1: Power supply, provided with 4 adapters
- 2: Configuration interface **XXZBOX01**
- 3: XX Configuration Software, installed on a PC
- 4: Ultrasonic sensor **XXS...**, **XXA...** or **XXW54P3HPL...**.

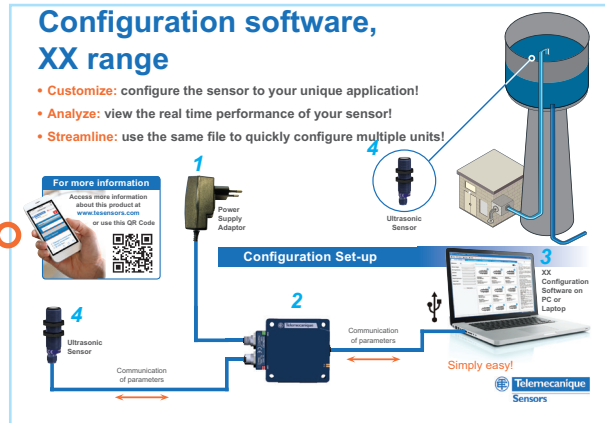

Setting examples

Sensor selection

- > This page is used to manually select or auto-download the XX reference sensor to be configured. Once a reference has been selected, the user can start the configuration process.
- > There are 4 methods of selection. The **Reset search** button can reinitialize the search, regardless of the method used.
 - 1: Direct selection from the full reference list
 - 2: Selection through reference
 - 3: Manual search using criteria
 - 4: Automatic sensor detection

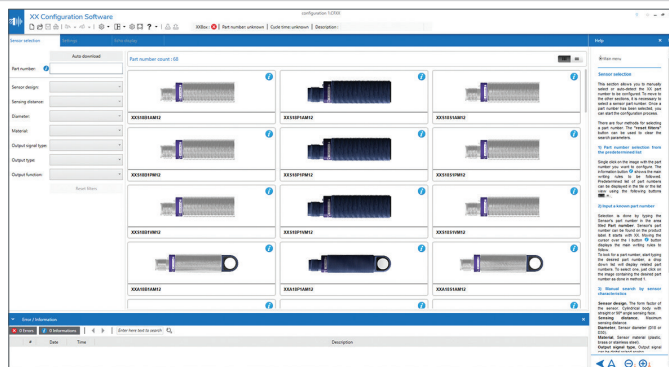

Detection settings

- > This tab is used to configure the sensor detection settings.

Hysteresis			Unexpected echoes		
Limit	Value	Unit	Limit	Value	Unit
Near	- 4 +	mm	Foreground	- 100 +	mm
Far	- 4 +	mm	Background	- 1020 +	mm

Change ON / OFF			Multiplexer	
Change	Value	Unit	Number of sensors	Address
ON	- 3 +	cycles	- 1 +	- 1 +
OFF	- 3 +	cycles		

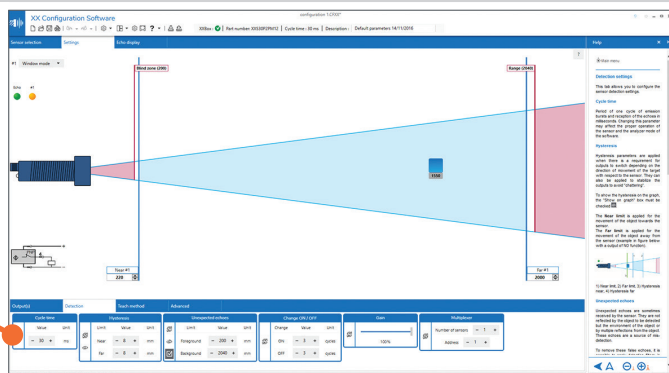

Output settings

- > This page enables the configuration of sensor outputs. If the sensor has several outputs, they may be configured separately, unless specified otherwise.

Output			Pulse length	
#	Type	Function	Value	Unit
1	PNP	NO	- 0 +	ms

Loss of echo		Delays		
Number of cycles	Output #1 state	Delay	Value	Unit
- 3 +	Non-detection	ON	- 0 +	ms
		OFF	- 0 +	ms

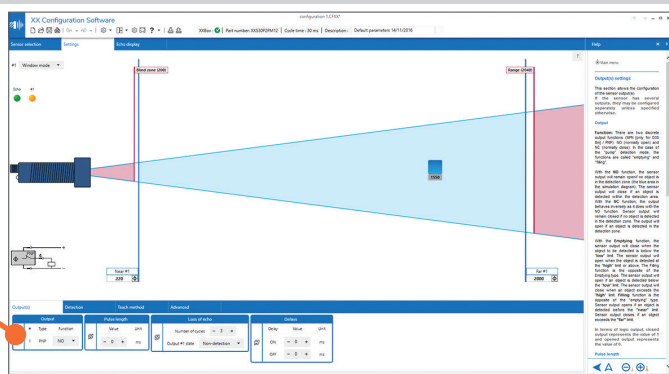

Configuration software presentation (continued)

Setting examples (continued)

Teach method settings

> This tab allows the configuration of the pushbutton for manual teaching. Depending on the sensor reference, the teach button is either integrated in the sensor or available through the teach pushbutton **XXZPB100** (see page 43).

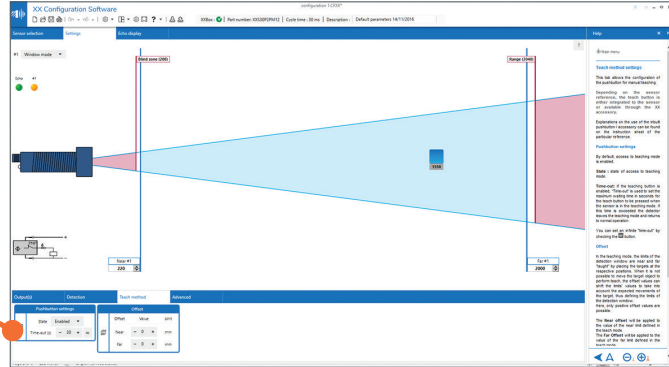

Echo display mode

- > With the “echo display” mode, the user can visualize several echoes received by the sensor in the same cycle.
- > The first valid echo is shown in blue and the others in gray. The blue echo is what the sensor considers as the detected object.
- > It is also possible to record the data over extended periods of time using the “record” function.

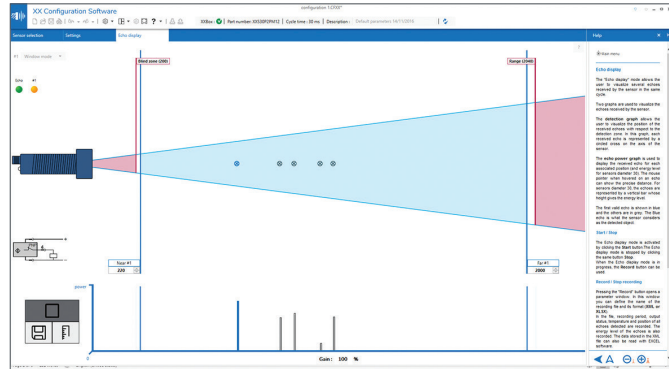

Measure mode

- > The “measure” button opens a pop-up window giving a real-time numerical display of the position of the object in mm or inches.

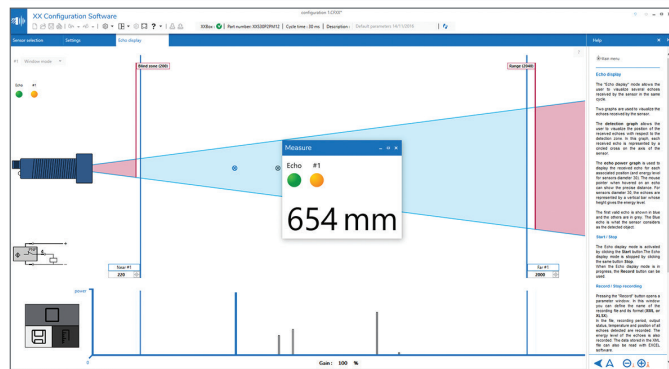

Characteristics

Supply characteristics

Rated supply voltage (Ue) with protection against reverse polarity	V	24 V $\overline{\text{DC}}$
Voltage limits	V	14...30 V $\overline{\text{DC}}$ (ripple: 10% max)
Consumption	W	4 (consumption excluding sensor)

LED indicators

LED indicators	Power supply	Green LED
	PC communication	Orange LED
	Error	Red LED

Communication

Data communication baud rate	bps	19,200
------------------------------	-----	--------

Connection

Maximum cabling distance between sensor and interface	m	3
Electrical connection to sensor		M12 female connector
Connection to PC or laptop		0.5 m USB cable , A type connector

Environment characteristics

Compliance to regulations		CE
Degree of protection	Conforming to IEC 60529	IP 40
Storage temperature	°C	-20...+45
Operating temperature	°C	0...+45
Relative humidity		< 95%, without condensation

Dimensions

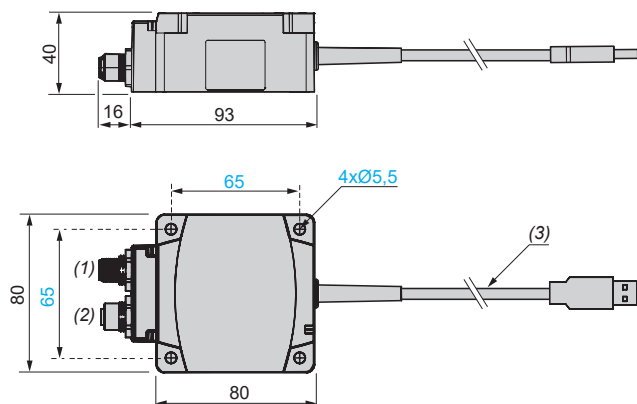

- (1) Male M12 connector, 5-pin: power supply
 (2) Female M12 connector, 5-pin: sensor
 (3) Cable length: 0.5 m (USB cable A type connector): PC

Connections

Interface connector for power supply adapter (M12 male)



Pin number	Wire color	Description
1	BN: Brown	+14...30 V $\overline{\text{DC}}$
2	WH: White	Output 2 (4) (5)
3	BU: Blue	0 V $\overline{\text{DC}}$
4	BK: Black	Output 1 (4)
5	–	Not used (6)

Interface connector for sensor (M12 female)



Pin number	Description
1	Power out to sensor
2	Software communication
3	0 V $\overline{\text{DC}}$
4	Software communication
5	Not used (6)

(4) Output is only active during the “echo display” mode and “measure” mode.

(5) Output 2 is not available on all sensors.

(6) The 5th pins of the M12 male and M12 female connectors are electrically connected to one another.

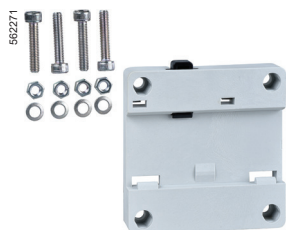
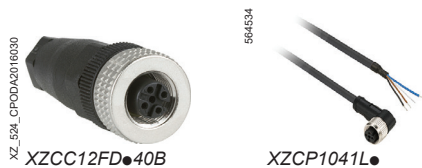

XSZBD10

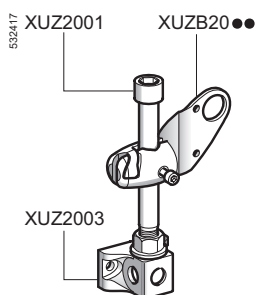

3D fixing kit example

References of accessories

Cabling accessories

Connectors	For use with sensor	Type of connection		Reference	Weight kg
M8 3-pin	∅ 12	IDC (Insulation Displacement Connector)	Straight	XZCC8FDM30V	0.010
	XX512A2●		Elbowed	XZCC8FCM30V	0.010
M8 4-pin	XX512A1●		Straight	XZCC8FDM40V	0.010
	XX●12A8●		Elbowed	XZCC8FCM40V	0.010
M12	∅ 18, ∅ 30	Screw terminals, metal clamping ring	Straight	XZCC12FDM40B	0.020
			Elbowed	XZCC12FCM40B	0.020
		Screw terminals, plastic clamping ring	Straight	XZCC12FDP40B	0.020
			Elbowed	XZCC12FCP40B	0.020

Pre-wired connectors	For use with sensor	Type	Cable length m	Reference	Weight kg
M8 3-pin	∅ 12 XX512A2●	Straight	2	XZCP0166L2 (1)	0.080
		Elbowed	2	XZCP0266L2 (1)	0.080
M12	∅ 18, ∅ 30	Straight	2	XZCP1141L2 (1)	0.090
		Elbowed	2	XZCP1241L2 (1)	0.090

Fixing accessories

Description	For use with sensor	Reference	Weight kg	
Fixing clamps	∅ 12	XSZB112	0.006	
	∅ 18	XSZB118	0.010	
	∅ 30	XSZB130	0.020	
Fixing clamps (mounting on 35 mm rail)	XX●D●	XSZBD10	0.065	
90° fixing bracket	∅ 12	XXZ12	0.025	
	∅ 18	XUZA118	0.038	
	∅ 30	XXZ30	0.115	
3D fixing kit (2)	M12 rod	∅ 12, ∅ 18 and ∅ 30	XUZ2001	0.050
	Support for M12 rod	∅ 12, ∅ 18 and ∅ 30	XUZ2003	0.160
	Ball-joint mounted fixing bracket	∅ 12	XUZB2012	0.175
		∅ 18	XUZB2003	0.175
	∅ 30	XUZB2030	0.160	

(1) For a 5 m long cable replace L2 by L5, for a 10 m long cable replace L2 by L10.

(2) To obtain a 3D fixing kit, order:

rod support **XUZ2003**, M12 rod **XUZ2001** and ball-joint mounted fixing bracket **XUZB20●●**

Dimensions of accessories

Fixing accessories

XUZA118

90° fixing bracket (Ø 18)

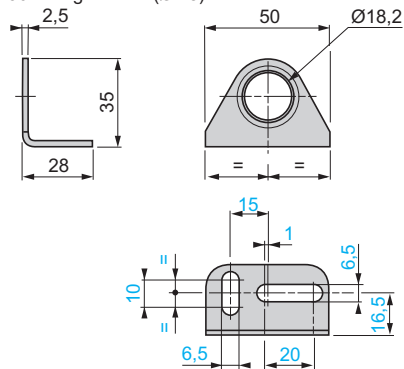

XXZ12, XXZ30

90° fixing bracket (Ø 12 and Ø 30)

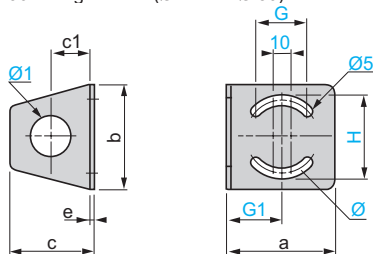

XXZ	a	b	c	c1	e	H	G	G1	Ø	Ø1
12	35	40	33	18	2	31	18	18	25	13
30	67	65	52	25	3	51	35	33	50	31

XSZB112, XSZB118

Fixing clamps (Ø 12, Ø 18 and Ø 30)

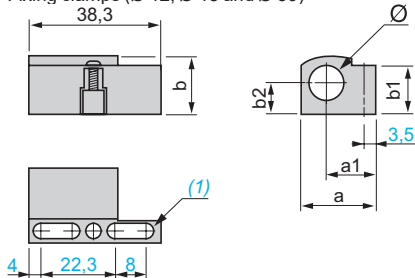

XSZ	a	a1	b	b1	b2	Ø
B112	21.9	14.5	16	15.5	8.5	12
B118	26	15.7	22.3	20.1	11.5	18
B130	39	21.7	35.5	31	18.5	30

(1) 2 elongated holes Ø 4 x 8.

XUZ2001

M12 rod

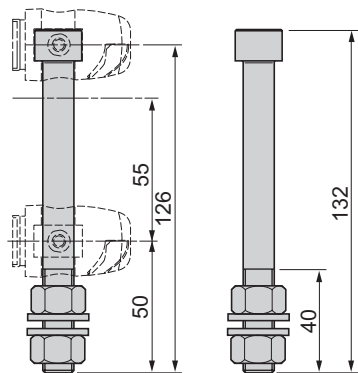

XUZ2003

Support for M12 rod

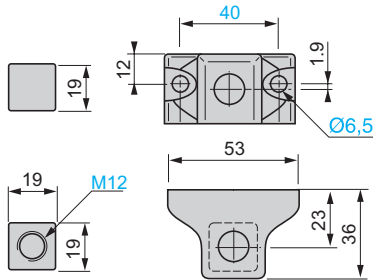

XSZBD10

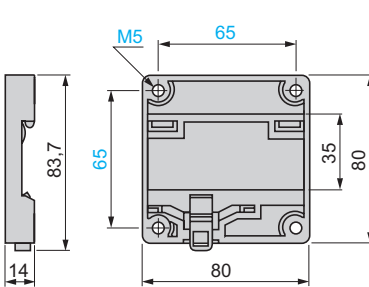

XUZB2012

Ball-joint mounted fixing bracket (Ø 12)

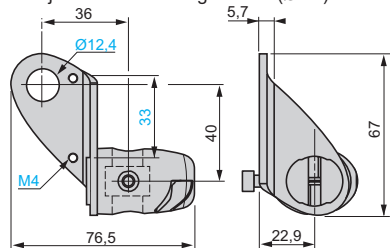

XUZB2003

Ball-joint mounted fixing bracket (Ø 18)

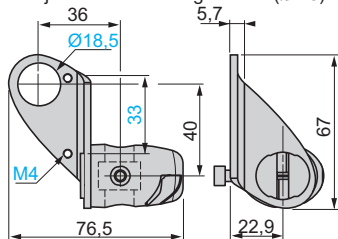

XUZB2030

Ball-joint mounted fixing bracket (Ø 30)

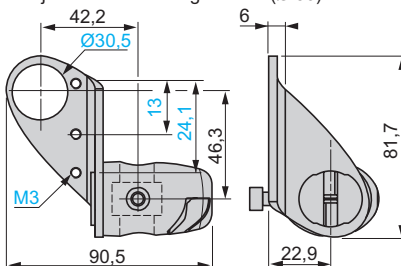

X							
XSZB112	78	XX930A3A1M12	36	XXS30P4VM12	42	XZCP1241L10	31
XSZB118	78	XX930A3A2M12	36	XXS30P8APM12	42	XZCPV11V12L2	31
XSZB130	78	XX930S1A1M12	36	XXS30P8NNM12	42		44
XSZBD10	78	XX930S1A2M12	36	XXS30P8PPM12	42	XZCPV11V12L5	31
XUZ2001	78	XXA18B1AM12	30	XXS30P8VPM12	42		44
XUZ2003	78	XXA18B1PM12	30	XXS30S1AM12	43	XZCPV11V12L10	31
XUZA118	78	XXA18B1VM12	30	XXS30S1PM12	42		44
XUZB2003	78	XXA18P1AM12	30	XXS30S1VM12	43	XZCPV12V12L2	31
XUZB2012	78	XXA18P1PM12	30	XXS30S2AM12	43		44
XUZB2030	78	XXA18P1VM12	30	XXS30S2PM12	42	XZCPV12V12L5	31
XX6V3A1NAM12	36	XXA18S1AM12	30	XXS30S2VM12	43	XZCPV12V12L10	31
XX6V3A1PAM12	36	XXA18S1PM12	30	XXS30S4AM12	43	XZCPV1164L2	44
XX7F1A2NAL01M12	68	XXA18S1VM12	30	XXS30S4PM12	42	XZCPV1164L5	44
XX7F1A2PAL01M12	68	XXA30B1AM12	43	XXS30S4VM12	43	XZCPV1164L10	44
XX7K1A2PAM12	68	XXA30B1PM12	42	XXT12A8M8	22	XZCPV1264L2	44
XX7V1A1NAM12	68	XXA30B1VM12	43	XXT18A3M12	26	XZCPV1264L5	44
XX7V1A1PAM12	68	XXA30B2AM12	43	XXT18A4M12	26	XZCPV1264L10	44
XX8D1A1NAM12	68	XXA30B2PM12	42	XXV18B1NAL2	22		
XX8D1A1PAM12	68	XXA30B2VM12	43	XXV18B1NAM12	22		
XX9D1A1C2M12	69	XXA30P1AM12	42	XXV18B1NBL5	22		
XX9D1A1F1M12	69	XXA30P1PM12	42	XXV18B1PAL2	22		
XX9V1A1C2M12	69	XXA30P1VM12	42	XXV18B1PAL5	22		
XX9V1A1F1M12	69	XXA30P2AM12	42	XXV18B1PAM12	22		
XX9V3A1C2M12	36	XXA30P2PM12	42	XXV18B1PBL2	22		
XX9V3A1F1M12	36	XXA30P2VM12	42	XXV18B1PBM12	22		
XX218A3PFM12	40	XXA30S1AM12	43	XXW54P3APL01DM6	63		
XX218A3PHM12	40	XXA30S1PM12	42	XXW54P3APL05	63		
XX230A10PA00M12	40	XXA30S1VM12	43	XXW54P3HPL01DM6	63		
XX230A11PA00M12	40	XXA30S2AM12	43	XXW54P3HPL05	63		
XX230A12NA00M12	40	XXA30S2PM12	42	XXZ12	78		
XX230A12PA00M12	40	XXA30S2VM12	43	XXZ30	78		
XX230A20PA00M12	40	XXR12A8KAM8	22	XXZB118	31		
XX230A21PA00M12	40	XXR18A3KAM12	26	XXZB130	44		
XX230A22PA00M12	40	XXR18A4KAM12	26	XXZBOX01	74		
XX512A1KAM8	22	XXS18B1AM12	30	XXZKIT01	74		
XX512A2NAM8	22	XXS18B1PM12	30	XXZKITDM6	63		
XX512A2PAM8	22	XXS18B1VM12	30	XXZPB100	26		
XX518A1KAM12	22	XXS18P1AM12	30		30		
XX518A3NAL2	26	XXS18P1PM12	30		40		
XX518A3NAM12	26	XXS18P1VM12	30		43		
XX518A3PAL2	26	XXS18S1AM12	30		68		
XX518A3PAM12	26	XXS18S1PM12	30		69		
XX630A1KAM12	36	XXS18S1VM12	30	XZCC8FCM30V	78		
XX630A1NCM12	36	XXS30B1AM12	43	XZCC8FCM40V	78		
XX630A1PCM12	36	XXS30B1PM12	42	XZCC8FDM30V	78		
XX630A2NCM12	36	XXS30B1VM12	43	XZCC8FDM40V	78		
XX630A2PCM12	36	XXS30B2AM12	43	XZCC12FCM40B	78		
XX630A3NCM12	36	XXS30B2PM12	42	XZCC12FCM50B	31		
XX630A3PCM12	36	XXS30B2VM12	43	XZCC12FCP40B	78		
XX630S1NCM12	36	XXS30B4AM12	43	XZCC12FDM40B	78		
XX630S1PCM12	36	XXS30B4PM12	42	XZCC12FDM50B	31		
XX918A3C2M12	26	XXS30B4VM12	43		44		
XX918A3F1M12	26	XXS30P1AM12	42	XZCC12FDP40B	78		
XX930A1A1M12	36	XXS30P1PM12	42	XZCP0166L2	78		
XX930A1A2M12	36	XXS30P1VM12	42	XZCP0266L2	78		
XX930A1A2230M12	36	XXS30P2AM12	42	XZCP1141L2	31		
XX930A2A1M12	36	XXS30P2PM12	42		78		
XX930A2A2M12	36	XXS30P2VM12	42	XZCP1141L5	31		
XX930A2A2230M12	36	XXS30P4AM12	42	XZCP1141L10	31		
		XXS30P4PM12	42	XZCP1241L2	31		
					78		
				XZCP1241L5	31		

Schneider Electric Industries SAS

Head Office
35, rue Joseph Monier
F-92500 Rueil-Malmaison
France

www.tesensors.com

The information provided in this documentation contains general descriptions and/or technical characteristics of the performance of the products contained herein. This documentation is not intended as a substitute for and is not to be used for determining suitability or reliability of these products for specific user applications. It is the duty of any such user or integrator to perform the appropriate and complete risk analysis, evaluation and testing of the products with respect to the relevant specific application or use thereof. Neither Schneider Electric nor any of its affiliates or subsidiaries shall be responsible or liable for misuse of the information contained herein.

Design: Schneider Electric
Photos: Schneider Electric

November 2021- V5.0

DIA4ED2191101EN