

**FESTO**

Simply part of the solution.



The Festo ★ core product range.

**Simply** part of the solution.  
The Festo core product range.

Edition 2020/02

All technical data is correct at the time of going to print.  
All texts, illustrations, images and drawings included in this catalogue are the intellectual property of Festo SE & Co. KG, and are protected by copyright law.  
No part of this publication may be reproduced or transmitted in any form or by any means, electronic, mechanical, photocopying or otherwise, without the prior written permission of Festo SE & Co. KG.

All technical data is subject to change according to technical updates.

Festo SE & Co. KG  
Postfach  
73726 Esslingen  
Ruiter Straße 82  
73734 Esslingen  
Germany

#### Legend



The stars will help you to find what you are looking for more quickly and place orders more easily. These star products are generally in stock and ready for immediate delivery.

**Black text on the product pages:**  
These products are included in this catalogue

**Blue type code on the product pages:**  
Type code for online searches

**Grey text on the product pages:**  
You can find these products online

#### Example

page 27:  
Ordering compact cylinders ADN-12-5-A-P-A  
★ 536204

More information → page 6

page 17:  
**Round cylinder**  
**DSNU**

page 17:  
**dsbg**

→ [www.festo.com/catalogue/dsbg](http://www.festo.com/catalogue/dsbg)

page 17:  
Standards-based cylinder  
DSBG

→ [www.festo.com/catalogue/dsbg](http://www.festo.com/catalogue/dsbg)

	<b>Editorial</b>	<b>2</b>	⊙
	<b>Pneumatic drives</b>	<b>14</b>	01
	<b>Grippers</b>	<b>52</b>	02
	<b>Electromechanical drives</b>	<b>58</b>	03
	<b>Motors and controllers</b>	<b>66</b>	04
	<b>Handling systems</b>	<b>72</b>	05
	<b>Vacuum technology</b>	<b>76</b>	06
	<b>Valves</b>	<b>80</b>	07
	<b>Valve terminals</b>	<b>112</b>	08
	<b>Sensors</b>	<b>118</b>	09
	<b>Compressed air preparation</b>	<b>134</b>	10
	<b>Pneumatic connection technology</b>	<b>158</b>	11
	<b>Electrical connection technology</b>	<b>176</b>	12
	<b>Control technology and software</b>	<b>184</b>	13
	<b>Other pneumatic equipment</b>	<b>188</b>	14
	<b>Process automation</b>	<b>194</b>	15
	<b>Appendix</b>	<b>218</b>	⊙



Editorial

# Axis definition

Find your handling solution in a few steps

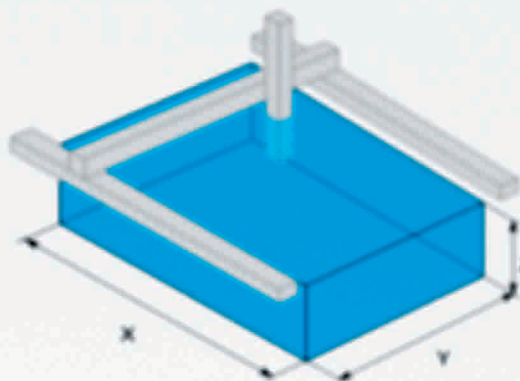

Define the drive system and working stroke

Drive system of the axis

Required working stroke

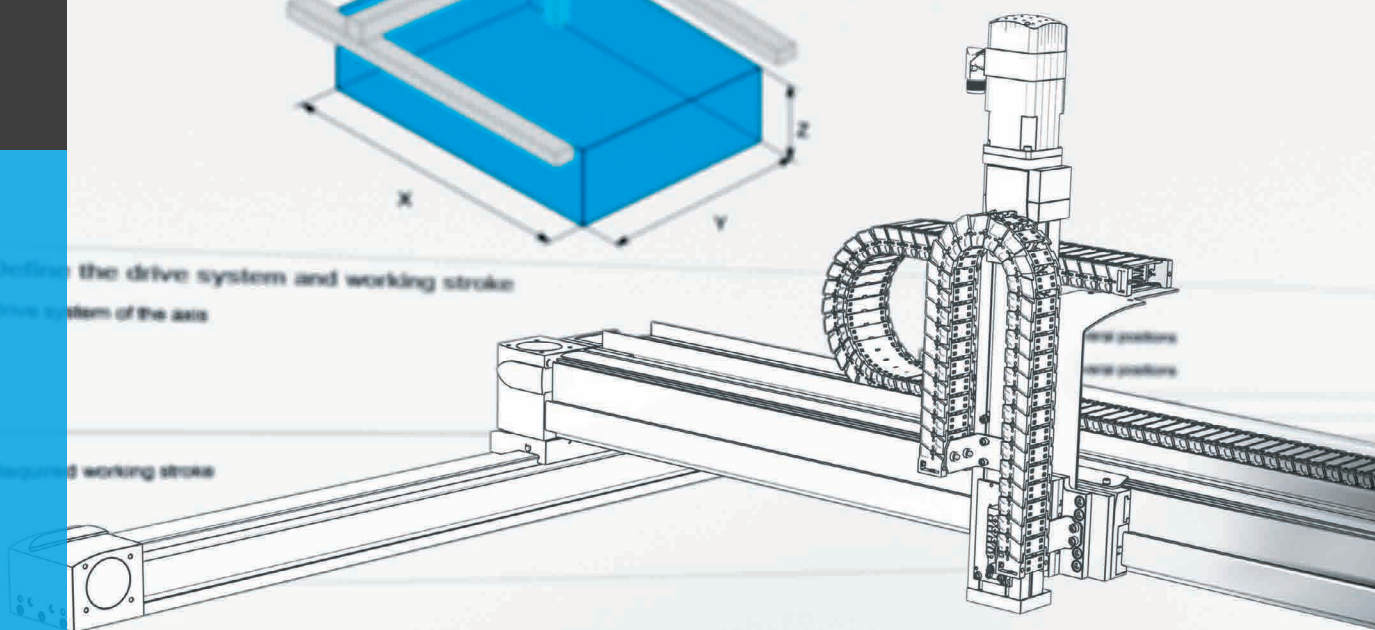



# Contents

Preface .....	4
Innovations for simpler automation .....	6
Digital products and services .....	8
Wide range of industry segments – one competent partner. ....	10
Your partner for safety .....	12



**We are pneumatic.  
We are electric.  
We are 30,000 technology-neutral solutions.**

**→ WE ARE THE ENGINEERS  
OF PRODUCTIVITY.**

## Dear customers and distribution partners,

Small, lightweight, highly functional, very attractively priced and available quickly worldwide: when we planned our core product range, these are the characteristics we focused on. With this in mind, we took a close look at many of our products and decided which needed only a rework and which we wanted to redesign from the ground up in order to best meet the above-mentioned criteria.

Our new catalogue for the core product range now contains precisely those products you can use in around 80% of all automation solutions. Even though the majority of them have been around for years, we are constantly adding new components to the core range of over 2200 products, most in multiple variants. The close cooperation between Development and Production ensured that our proven Festo quality remains unchanged, but a significant reduction in manufacturing times – of 50% in some cases.

The redesigned and standardised products therefore offer top quality and unparalleled functionality at very attractive prices for you and your customers – you have my word on it. Just open the catalogue and take a look at the following products:

- The short round cylinder DSNU-S. Interesting if space is limited in your design.
- The extremely small and lightweight compact cylinders ADN-S. For outstanding performance with small movements.
- The new mini slide DGST. The smallest in its class, but still a powerful solution.
- The universal directional control valves VUVG. Sturdy and durable, even in very large quantities – and at a low price!
- The very compact and lightweight regulators and filter regulators MSB4 with a flow rate of 1800 l/min. Perfect for use at the front end and in end-of-arm solutions.
- The many variants of plastic tubing PUN-H. Highly resistant to microbes and hydrolysis and food-safe.
- The positioner CMSX for process automation. No compressed air consumption when the machine is at a standstill and ideal for flow control of process valves, e.g. for dispensing or mixing.

At the same time, we worked consistently on our production and delivery capacities. This is how we ensure worldwide that you receive the products you ordered promptly, even in large quantities.

Of course we're also there for you if you need another solution. With electric, pneumatic and digitised automation, whether in factory or process automation. Our goal is to offer you precisely those solutions, services and training that are best for you. Including across technologies. This makes us the engineers of productivity. Make the most of our expertise!



Dr. Ansgar Kriwet  
Member of the Management Board, Sales, Festo SE

You rely on factory automation.  
You rely on process automation.  
We are technology and education.

→ **WE ARE THE ENGINEERS  
OF PRODUCTIVITY.**

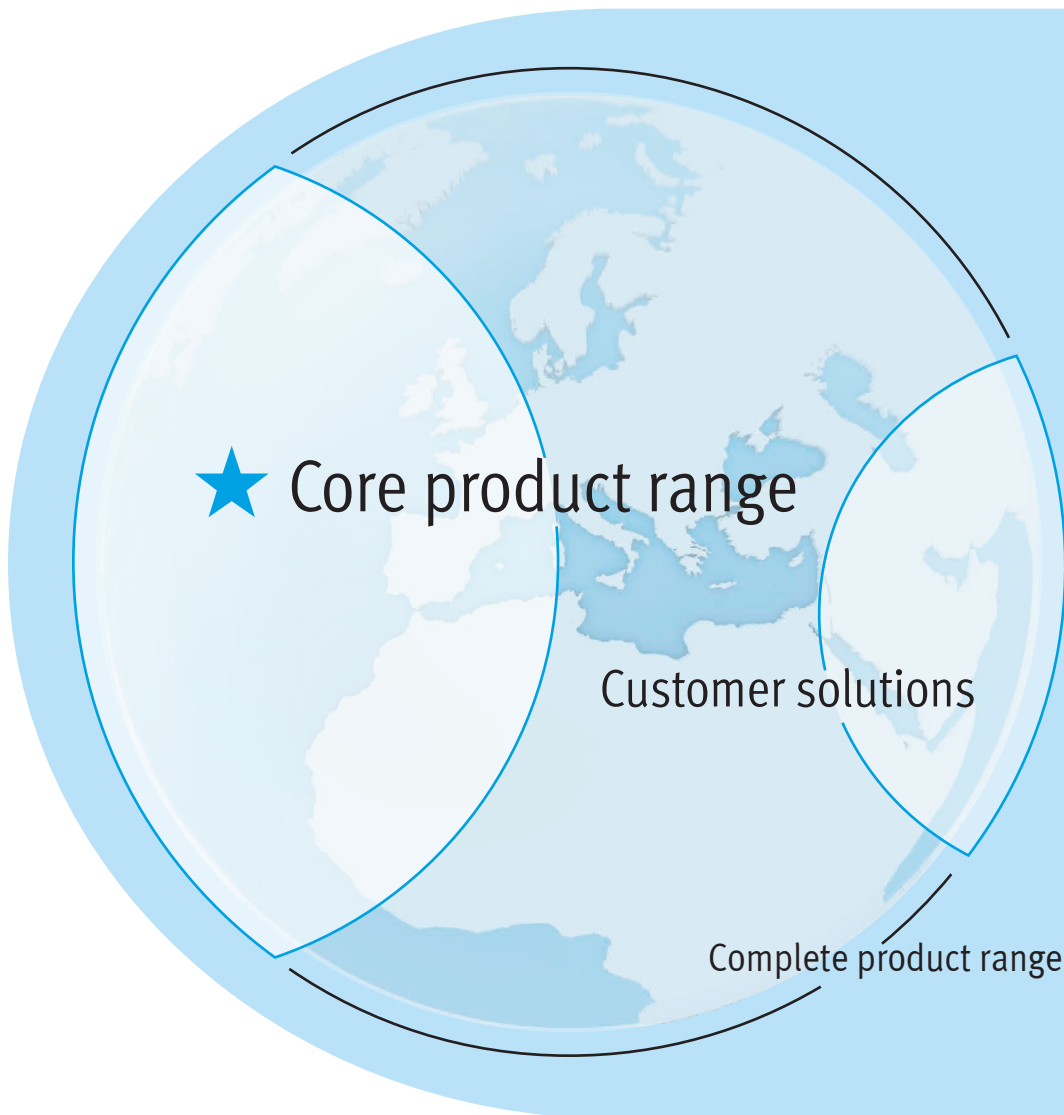



## Product range

Producere – implement in advance.

Until the turn of the millennium, production was essentially still synonymous with building up a stock of an item. Now it is better described as “being prepared”, since needs, parameters and processes change rapidly and require thinking and action on several fronts at the same time.

Festo is facing these challenges too, and offers you different levels of solutions in its range.

# 1

### Core Range

Our Core Range offers you special benefits – selected products that solve the majority of your automation tasks. They can be ordered by part number and are particularly attractively priced.



- **Quickest delivery, worldwide – wherever, whenever**
- Best value
- Easy and fast to select

**Just look for the star!**

# 2

### Total product range

You will find solutions for more specific requirements in our total product range, which we will deliver on the indicated date. This part of the range is not specifically identified and also covers innovative cross-technology combinations of products right up to products that carry the seeds of digitalisation within them.

# 3

### Customer solutions

If you cannot find the right products for your task in our range, our specialists in the Customer Solutions department are always available to provide support.

Your partner for all automation questions.  
Get in touch with us at → [www.festo.com](http://www.festo.com)

## Digital products and services

### Comprehensive digitalisation concepts

All our development activities for digitalised automation revolve around one question: how can we make you more productive across the entire value chain? From initial engineering, procurement and commissioning to maintenance and operation? No matter where you are in this value chain, at Festo you will find the right digital offer for your needs.

You can already optimise your production and your processes with data analytics, machine learning and artificial intelligence from Festo. With these methods, this transformation will result in new business models.

Software tools from Festo support you in every phase of the machine lifecycle, from initial planning to the modernisation of your plant. They are small, practical tools that make your work easier and much more productive. We have compiled a selection of them here.

→ [www.festo.com/engineeringtools](http://www.festo.com/engineeringtools)

### Pneumatic Sizing



→ [www.festo.com/pneumaticsizing](http://www.festo.com/pneumaticsizing)

You may have already asked yourself: isn't there a quicker and more accurate way to calculate the optimal pneumatic control chain? Yes, there is! Pneumatic Sizing doesn't just offer you one design version, but up to three that are suitable for your application. By entering three application parameters such as load, stroke and positioning time, you will get up to three suggestions: the precise result as well as the performance and eco versions.

Pneumatic Sizing allows you to benefit from:

- Optimal air consumption
- The ideal travel time per cycle
- Direct connections to the Festo Online Shop.

### Festo Design Tool 3D

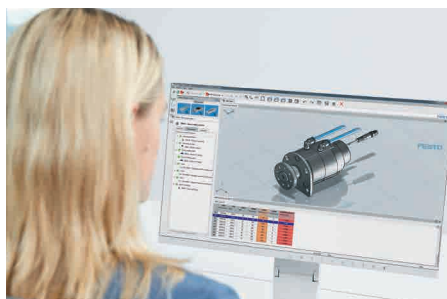

→ [www.festo.com/fdt-3d-online](http://www.festo.com/fdt-3d-online)

Festo Design Tool 3D is a 3D product configurator for generating Festo-specific CAD product combinations. Your search for matching accessories for standard components with fast delivery, for example for pneumatic cylinder series DSBC, DSNU and ADN, will be faster, more reliable and easier in the future. At the same time your documentation effort is reduced and traceability is simple: generate PDF assembly drawings and bills of materials within the Festo Design Tool 3D and query the traceable order code in the Support Portal.

The benefits for design, purchasing and commissioning:

- Quick and easy automated generation of product combinations
- Shorter bills of materials, fewer sources of error and optimised ordering processes thanks to a single order code for the complete assembly
- Native CAD models for retaining CAD/component links (CAD Constraints, CAD Mates)
- Simplified, accelerated processes in the warehouse and during assembly

## Schematic Solution for EPLAN projects

This circuit diagram service for complete EPLAN projects is unique to Festo: EPLAN Schematic Solution documents your individually configured solutions in next to no time. 3D CAD data and product information for standard catalogue products have been available for 15 years. With EPLAN Schematic Solution you simply enter the order code and receive the complete plan in just a few minutes – error-free and trouble-free. No more tedious searching for, downloading and piecing together individual components.

- Intuitive, fast and reliable: error-free documentation at the push of a button
- Full mechatronic layout of configured products like CPX, VTSA, MPA
- Reliably automated in accordance with the standards IEC 61355, IEC 81346, ISO 1219



→ [www.festo.com/eplan](http://www.festo.com/eplan)

## FluidDraw – circuit diagrams for complete systems

Planning and documenting electric and pneumatic components in your system have never been easier. FluidDraw gives you direct access to the catalogue and any online baskets you saved at Festo, as well as letting you import additional databases and use a standardised symbol library. For maximum convenience choose the FluidDraw 365 software subscription with regular updates and the latest upgrades.

- IMX and Eplan interfaces
- Tubing lengths, wire and cable lengths
- Standardised hydraulic symbols to ISO 1219



→ [www.festo.com/fluiddraw](http://www.festo.com/fluiddraw)

## Smartenance – the digital maintenance manager

Smartenance makes your maintenance management paperless, transparent and efficient. It lets production managers, system operators and maintenance staff schedule autonomous maintenance tasks, report faults on the move and document all their measures. While the web-based application provides administrative support, the app gives access to maintenance schedules and attachments from anywhere. Smartenance is quick and easy to install, self-explanatory and a simple and cost-effective introduction to digitalisation.

- For production managers and plant operators: digital maintenance management directly on the shop floor
- For auditors: detailed proof with one click
- Cloud-based: mobile access from anywhere
- Feedback function: quick and easy collaboration in the maintenance team
- Seamless connectivity thanks to API
- Complete documentation of all activities



→ [www.festo.com/smartenance](http://www.festo.com/smartenance)

## The Festo App World

Festo has set up a separate portal, the Festo App World, for purchasing and using the apps, cloud products, software libraries and added value services.

You can make purchases directly online here, view the relevant apps for your hardware via your Product Key as well as your order history, and set up subscription models or subscriptions.

Simply log in with your Festo account, select the digital product you want, and add it to your basket. You can also just forward the basket to the appropriate colleagues authorised to make purchases.



→ [www.festo.com/appworld](http://www.festo.com/appworld)

Wide range of industry segments – one competent partner.

## Food and packaging industry



From continuous processes through food and splash zones to end line packaging:

- Solutions for controlling special media flows
- Food-safe materials for automation components in clean design
- Handling systems with suitable gripper solutions
- Technology mix: electric, pneumatic and servo-pneumatic

→ [www.festo.com/food](http://www.festo.com/food)

→ [www.festo.com/packaging](http://www.festo.com/packaging)

## Automotive industry and Tier 1 suppliers



- Understanding the processes – from the press shop through to engine and transmission production and Tier 1 suppliers
- Developing solutions – joint engineering projects
- Creating synergies – everything from a single source

→ [www.festo.com/automotive](http://www.festo.com/automotive)

## Small parts assembly and electronics



- Know-how along the entire process chain
- From wafer production at the front end to finished chips at the back end
- For quality inspection and assembly of the finished products
- In small parts assembly, electronic or non-electronic

→ [www.festo.com/ela](http://www.festo.com/ela)

Wide range of industry segments – one competent partner.

## Water treatment



- Integrated automation solutions for the key processes: water and wastewater treatment
- Customer-oriented consulting and engineering
- Supply of components and pre-assembled systems
- Compressed air quality analyses
- Energy Saving Services

→ [www.festo.com/water](http://www.festo.com/water)

## Biotech, pharma and cosmetics industry

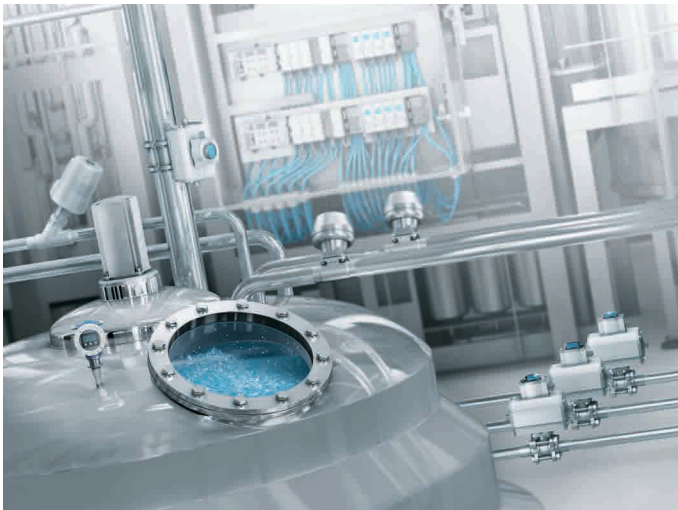

- Integrated automation solutions for the key processes: production of active ingredients, manufacturing of pharmaceuticals, cosmetics and personal care products, filling and packaging
- Customer-oriented consulting and engineering
- Supply of components and pre-assembled systems
- Compressed air quality analyses
- Energy Saving Services

→ [www.festo.com/biotech](http://www.festo.com/biotech)

Your partner for safety

# Reduce risk – think preventively: Safety@Festo

Machines have to be designed in a way that protects people, animals, property and the environment from harm. The objective is to prevent physical damage of any type. With safety-oriented pneumatics from Festo, you can be sure that implemented safety measures are in compliance with the EC Machinery Directive. Festo offers many safety solutions for the entire control chain in the area of electrics and pneumatics, for input, logic and output.

These can be individual products, customer-specific solutions, proposals for safety-related circuit diagrams or training courses. Festo Didactic offers training and consulting services on standards and directives as well as risk assessments and assessments of technical safety measures.

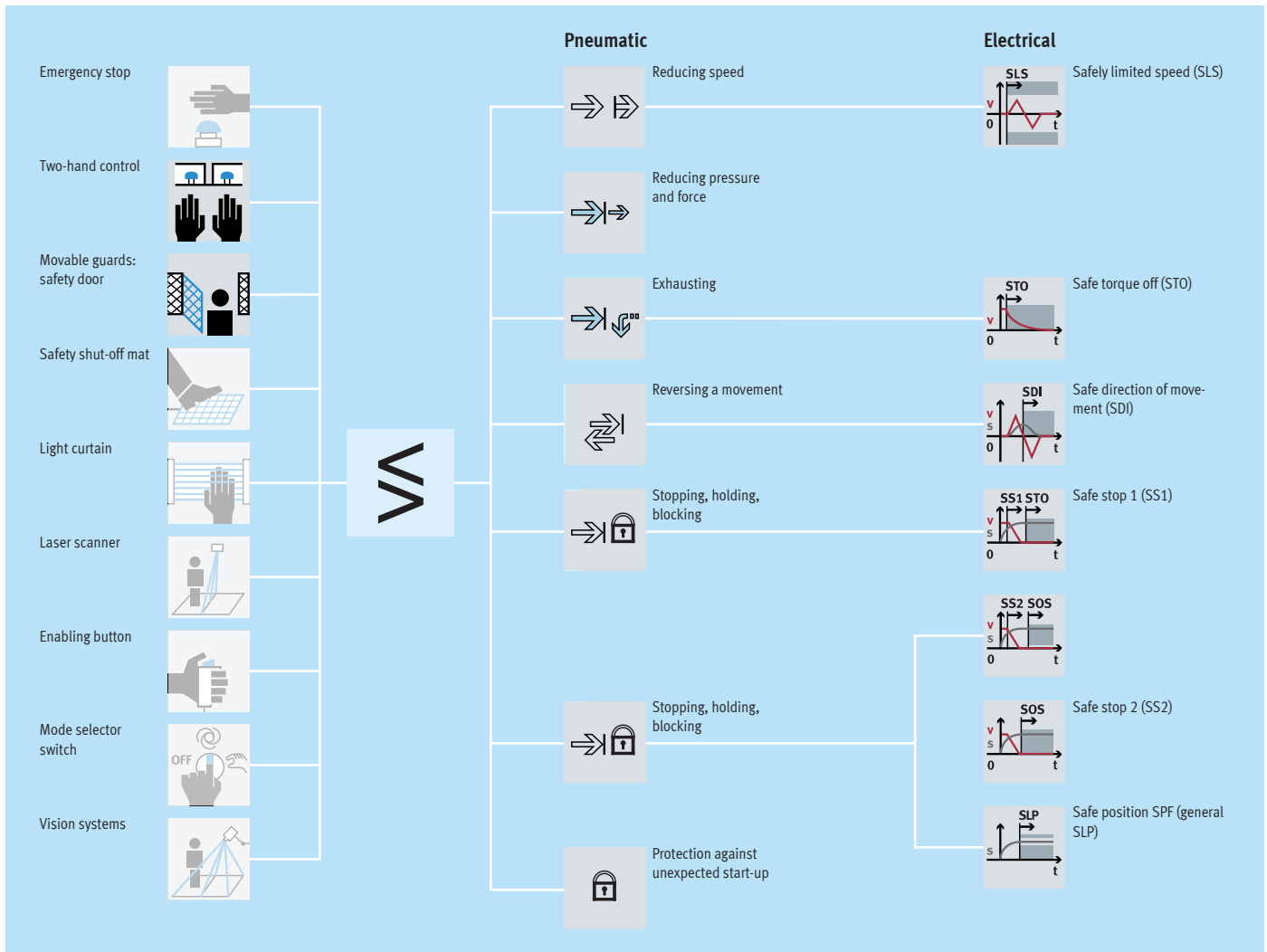

Just ask your local contact person or find out more at [www.festo.com/safety](http://www.festo.com/safety)



# 01

## Pneumatic drives

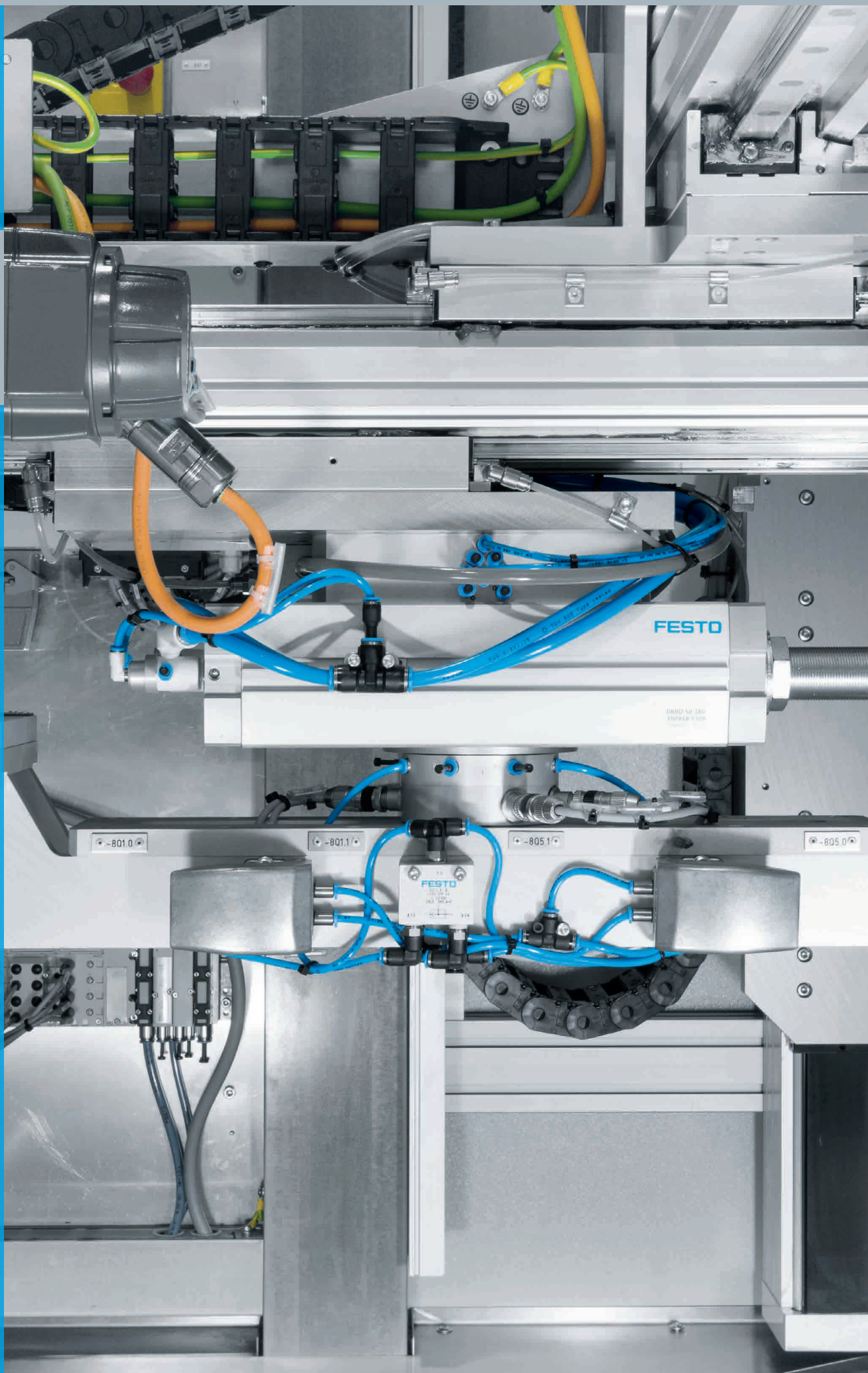



# Highlights



Compact cylinders  
**ADN-S**  
+ Minimal installation space  
+ Ideal for small movements  
→ 38



Mini slides  
**DGST**  
+ Powerful twin-piston drive  
+ Shortest mini slide on the market  
+ Precision recirculating ball bearing guide  
+ Versatile mounting options  
→ 46

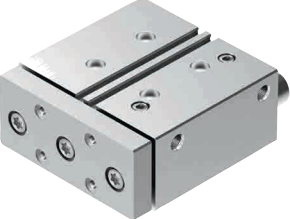

Guided drives  
**DFM**  
+ Minimal cycle times  
+ High load capacity with integrated guides  
+ Wide range of mounting options  
→ 48

# Contents

Product overview \_\_\_\_\_ 16  
 Self-adjusting end-position cushioning PPS for standards-based cylinders \_\_\_\_ 24  
 Compact cylinders ADN, to ISO 21287, double-acting ★ \_\_\_\_\_ 26  
 Standards-based cylinders DSBC, to ISO 15552, double-acting ★ \_\_\_\_\_ 29  
 Round cylinders DSNU, to ISO 6432, double-acting ★ \_\_\_\_\_ 32  
 Round cylinders DSNU, double-acting ★ \_\_\_\_\_ 34  
 Round cylinders DSNU-S, double-acting ★ \_\_\_\_\_ 36  
 Compact cylinders ADN-S, double-acting ★ \_\_\_\_\_ 38  
 Short-stroke cylinders ADVC, AEVC, double-acting/single-acting ★ \_\_\_\_\_ 39  
 Semi-rotary drives DRVS, double-acting ★ \_\_\_\_\_ 42  
 Twin-piston semi-rotary drives DRRD, double-acting ★ \_\_\_\_\_ 44  
 Mini slides DGST, double-acting ★ \_\_\_\_\_ 46  
 Guided drives DFM, double-acting ★ \_\_\_\_\_ 48  
 Piston rod attachments SG, SGS, FK ★ \_\_\_\_\_ 50

Product overview

Software-Tools

Pneumatic drives

**Pneumatic simulation**

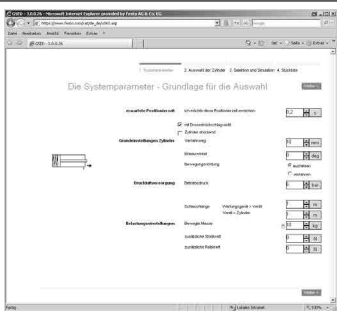

Perfect simulations replace expensive real-life tests. The tool is an expert system that supports you in the selection and configuration of the entire pneumatic control chain. If one parameter is changed, the program automatically adapts all the others.

This tool can be found  
 • on our website at [www.festo.com/catalogue](http://www.festo.com/catalogue) by clicking on the blue button 'Engineering'.

**Festo Design Tool 3D**

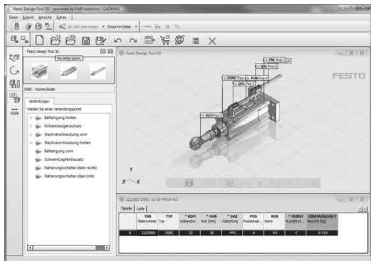

The Festo Design Tool 3D is a 3D product configurator for generating specific CAD product combinations from Festo. The configurator makes your search for the right accessory easier, more reliable and faster.

You can then order the module that has been created as a single order item, either completely pre-assembled or as individual parts in a single box. This considerably reduces your bill of materials, and downstream processes such as product ordering, order picking and assembly are significantly simplified.

All ordering options are available in the following countries:  
 AT, BE, CH, CZ, DE, DK, ES, EST, FI, FR, GB, GR, HU, IE, IT, NL, NO, PL, PT, RU, SE, SI, SK, TR, ZA.

This tool can be found  
 • at: [www.festo.com/fdt-3d-online](http://www.festo.com/fdt-3d-online) in the above listed countries.

Standards-based cylinders







**Compact cylinders  
ADN**





**Standards-based cylinders  
DSBC**

	Compact cylinders ADN	Standards-based cylinders DSBC
<b>Operating mode</b>	Double-acting	Double-acting
<b>Piston diameter</b>	12 mm, 16 mm, 20 mm, 25 mm, 32 mm, 40 mm, 50 mm, 63 mm, 80 mm, 100 mm, 125 mm	32 mm, 40 mm, 50 mm, 63 mm, 80 mm, 100 mm, 125 mm
<b>Theoretical force at 6 bar, advancing</b>	51 ... 7363 N	415 ... 7363 N
<b>Stroke</b>	1 ... 500 mm	1 ... 2800 mm
<b>Cushioning</b>	Elastic cushioning rings/plates at both ends, self-adjusting pneumatic end-position cushioning	Elastic cushioning rings/plates at both ends, self-adjusting pneumatic end-position cushioning, pneumatic cushioning, adjustable at both ends
<b>Description</b>	<ul style="list-style-type: none"> <li>• ISO 21287</li> <li>• Up to 50% less installation space than comparable standards-based cylinders to ISO 15552</li> <li>• Piston rod with female or male thread</li> <li>• Wide range of variants for customised applications</li> <li>• For position sensing</li> </ul>	<ul style="list-style-type: none"> <li>• ISO 15552 (ISO 6431, VDMA 24562)</li> <li>• Self-adjusting pneumatic end-position cushioning which adapts optimally to changes in load and speed</li> <li>• Standard profile with two sensor slots</li> <li>• Wide range of variants for customised applications</li> <li>• Comprehensive range of mounting accessories for just about every type of installation</li> <li>• For position sensing</li> </ul>
<b>→ Page/online</b>	26	29

## Standards-based cylinders



	 Standards-based cylinders DSBG	 Standards-based cylinders DSBG	 Standards-based cylinders, clean design DSBF-C	 Round cylinders DSNU
<b>Operating mode</b>	Double-acting	Double-acting	Double-acting	Double-acting
<b>Piston diameter</b>	32 mm, 40 mm, 50 mm, 63 mm, 80 mm, 100 mm, 125 mm	160 mm, 200 mm, 250 mm, 320 mm	32 mm, 40 mm, 50 mm, 63 mm, 80 mm, 100 mm, 125 mm	8 mm, 10 mm, 12 mm, 16 mm, 20 mm, 25 mm
<b>Theoretical force at 6 bar, advancing</b>	415 ... 7363 N	12064 ... 48255 N	415 ... 7363 N	23 ... 295 N
<b>Stroke</b>	1 ... 2800 mm	1 ... 2700 mm	1 ... 2800 mm	1 ... 500 mm
<b>Cushioning</b>	Elastic cushioning rings/plates at both ends, self-adjusting pneumatic end-position cushioning, pneumatic cushioning, adjustable at both ends	Elastic cushioning rings/plates at both ends, pneumatic cushioning adjustable at both ends	Elastic cushioning rings/plates at both ends, self-adjusting pneumatic end-position cushioning, pneumatic cushioning, adjustable at both ends	Elastic cushioning rings/plates at both ends, self-adjusting pneumatic end-position cushioning, pneumatic cushioning, adjustable at both ends
<b>Description</b>	<ul style="list-style-type: none"> <li>• ISO 15552 (ISO 6431, VDMA 24562)</li> <li>• Sturdy tie rod design</li> <li>• Self-adjusting pneumatic end-position cushioning which adapts optimally to changes in load and speed</li> <li>• Comprehensive range of mounting accessories for just about every type of installation</li> <li>• For position sensing</li> </ul>	<ul style="list-style-type: none"> <li>• ISO 15552 (ISO 6431, VDMA 24562)</li> <li>• Sturdy tie rod design</li> <li>• Pneumatic end-position cushioning adjustable at both ends</li> <li>• Optionally without adjustable pneumatic cushioning at both ends, and position sensing, resulting in a price advantage</li> <li>• Optionally with spacer bolt attachment</li> <li>• For position sensing</li> </ul>	<ul style="list-style-type: none"> <li>• ISO 15552</li> <li>• Increased corrosion protection</li> <li>• Easy-to-clean design</li> <li>• FDA-approved lubrication and sealing on the basic design</li> <li>• Long service life thanks to optional dry-running seal</li> <li>• Self-adjusting pneumatic end-position cushioning which adapts optimally to changes in load and speed</li> <li>• For position sensing</li> </ul>	<ul style="list-style-type: none"> <li>• ISO 6432</li> <li>• Wide range of variants for customised applications</li> <li>• Good running performance and long service life</li> <li>• Self-adjusting pneumatic end-position cushioning which adapts optimally to changes in load and speed</li> <li>• Piston rod with female or male thread</li> <li>• For position sensing</li> </ul>
<b>→ Page/online</b>	<a href="#">dsbg</a>	<a href="#">dsbg</a>	<a href="#">dsbf</a>	32

## Round cylinders





	 Round cylinders DSNU	 Round cylinders DSNU-S
<b>Operating mode</b>	Double-acting	Double-acting
<b>Piston diameter</b>	32 mm, 40 mm, 50 mm, 63 mm	8 mm, 12 mm, 16 mm, 20 mm, 25 mm
<b>Theoretical force at 6 bar, advancing</b>	482.5 ... 1870.3 N	30.2 ... 294.5 N
<b>Stroke</b>	1 ... 500 mm	1 ... 200 mm
<b>Cushioning</b>	Elastic cushioning rings/plates at both ends, self-adjusting pneumatic end-position cushioning, pneumatic cushioning, adjustable at both ends	Elastic cushioning rings/plates at both ends, self-adjusting pneumatic end-position cushioning
<b>Description</b>	<ul style="list-style-type: none"> <li>• Wide range of variants for customised applications</li> <li>• Good running performance and long service life</li> <li>• Self-adjusting pneumatic end-position cushioning which adapts optimally to changes in load and speed</li> <li>• Piston rod with female or male thread</li> <li>• For position sensing</li> </ul>	<ul style="list-style-type: none"> <li>• Compact variant of standards-based cylinder DSNU</li> <li>• Wide range of variants for customised applications</li> <li>• Self-adjusting pneumatic end-position cushioning which adapts optimally to changes in load and speed</li> <li>• Piston rod with male thread</li> <li>• For position sensing</li> </ul>
<b>→ Page/online</b>	34	36

Product overview



Stainless-steel cylinders

	 Round cylinders CRDSNU, CRDSNU-B	 Round cylinders CRDSNU, CRDSNU-B
<b>Operating mode</b>	Double-acting	Double-acting
<b>Piston diameter</b>	12 mm, 16 mm, 20 mm, 25 mm	32 mm, 40 mm, 50 mm, 63 mm
<b>Theoretical force at 6 bar, advancing</b>	68 ... 295 N	483 ... 1870 N
<b>Stroke</b>	1 ... 500 mm	1 ... 500 mm
<b>Cushioning</b>	Elastic cushioning rings/plates at both ends, self-adjusting pneumatic end-position cushioning, pneumatic cushioning, adjustable at both ends	Elastic cushioning rings/plates at both ends, self-adjusting pneumatic end-position cushioning, pneumatic cushioning, adjustable at both ends
<b>Description</b>	<ul style="list-style-type: none"> <li>• ISO 6432</li> <li>• Corrosion-resistant against aggressive ambient conditions</li> <li>• Easy-to-clean design</li> <li>• Long service life thanks to optional unlubricated seal</li> <li>• Wide range of variants for customised applications</li> <li>• Self-adjusting pneumatic end-position cushioning which adapts optimally to changes in load and speed</li> <li>• For position sensing</li> </ul>	<ul style="list-style-type: none"> <li>• Corrosion-resistant against aggressive ambient conditions</li> <li>• Easy-to-clean design</li> <li>• Long service life thanks to optional unlubricated seal</li> <li>• Wide range of variants for customised applications</li> <li>• Self-adjusting pneumatic end-position cushioning which adapts optimally to changes in load and speed</li> <li>• For position sensing</li> </ul>
<b>→ Page/online</b>	<a href="#">crdsnu</a>	<a href="#">crdsnu</a>

Compact, short-stroke and flat cylinders

	 Compact cylinders ADN-S	 Compact cylinders AEN-S	 Compact cylinders ADN	 Short-stroke cylinders ADVC, AEVC
<b>Operating mode</b>	Double-acting	Pushing	Double-acting	Double-acting, pushing, single-acting
<b>Piston diameter</b>	6 mm, 10 mm	6 mm, 10 mm	12 mm, 16 mm, 20 mm, 25 mm, 32 mm, 40 mm, 50 mm, 63 mm, 80 mm, 100 mm, 125 mm	4 mm, 6 mm, 10 mm, 12 mm, 16 mm, 20 mm, 25 mm, 32 mm, 40 mm, 50 mm, 63 mm, 80 mm, 100 mm
<b>Theoretical force at 6 bar, advancing</b>	17 ... 47 N	13 ... 41.7 N	51 ... 7363 N	4.9 ... 4712 N
<b>Stroke</b>	5 mm, 10 mm	5 mm, 10 mm	1 ... 500 mm	2.5 ... 25 mm
<b>Cushioning</b>	No cushioning	No cushioning	Elastic cushioning rings/plates at both ends, self-adjusting pneumatic end-position cushioning	Elastic cushioning rings/plates at both ends
<b>Description</b>	<ul style="list-style-type: none"> <li>• Minimal installation space</li> <li>• Improved running characteristics thanks to precise manufacturing from a single piece</li> <li>• Piston rod with female or male thread</li> <li>• For position sensing</li> </ul>	<ul style="list-style-type: none"> <li>• Minimal installation space</li> <li>• Improved running characteristics thanks to precise manufacturing from a single piece</li> <li>• High forces in a compact size</li> <li>• Piston rod with female or male thread</li> <li>• For position sensing</li> </ul>	<ul style="list-style-type: none"> <li>• ISO 21287</li> <li>• Up to 50% less installation space than comparable standards-based cylinders to ISO 15552</li> <li>• Piston rod with female or male thread</li> <li>• Wide range of variants for customised applications</li> <li>• For position sensing</li> </ul>	<ul style="list-style-type: none"> <li>• Very short overall length</li> <li>• High forces in a compact size</li> <li>• Piston rod with female or male thread</li> <li>• For position sensing via proximity sensor for T-slot and for C-slot</li> <li>• Mounting hole pattern according to VDMA 24562 as of Ø 32 mm</li> </ul>
<b>→ Page/online</b>	<a href="#">38</a>	<a href="#">aen-s</a>	<a href="#">26</a>	<a href="#">39</a>

## Rodless cylinders

	 Linear drives DGC-K	 Linear drives DGC-G, DGC-GF, DGC-KF
<b>Piston diameter</b>	18 mm, 25 mm, 32 mm, 40 mm, 50 mm, 63 mm, 80 mm	8 mm, 12 mm, 18 mm, 25 mm, 32 mm, 40 mm, 50 mm, 63 mm
<b>Theoretical force at 6 bar, advancing</b>	153 ... 3016 N	30 ... 1870 N
<b>Stroke</b>	1 ... 8500 mm	1 ... 8500 mm
<b>Cushioning</b>	Pneumatic cushioning adjustable at both ends	Elastic cushioning rings/plates at both ends, pneumatic cushioning adjustable at both ends, shock absorber, hard characteristic curve, shock absorber, soft characteristic curve
<b>Position sensing</b>	Via proximity switch	Via proximity switch
<b>Description</b>	<ul style="list-style-type: none"> <li>• Compact design: 30% smaller than the basic design DGC-G</li> <li>• Basic drive without guide, for simple drive functions</li> <li>• Low moving dead weight</li> <li>• Symmetrical design</li> </ul>	<ul style="list-style-type: none"> <li>• Basic design, plain or recirculating ball bearing guide</li> <li>• All settings accessible from one side</li> <li>• Optionally with variable end stops and intermediate position module</li> <li>• Software tool available for bearing calculation</li> <li>• Optional: NSF-H1 lubricant for the food zone (see <a href="http://www.festo.com/sp/dgc">www.festo.com/sp/dgc</a> &gt; "Certificates" tab)</li> <li>• Optional: clamping unit for holding loads</li> </ul>
<b>→ Page/online</b>	<a href="#">dgc</a>	<a href="#">dgc</a>

Product overview

Software-Tools

Pneumatic drives

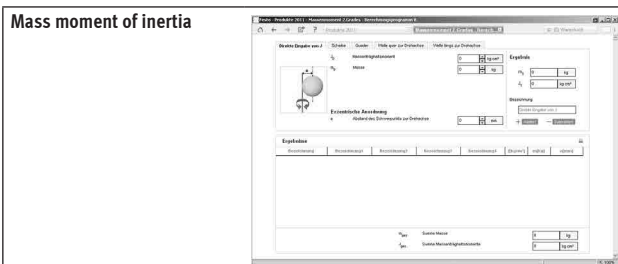

Juggling pencils and pocket calculators is now a thing of the past. Whether you have discs, blocks, push-on flanges, grippers, etc., this tool does the job of calculating all the mass moments of inertia. Just save, send or print and you're finished.

This tool can be found

- on our website at [www.festo.com/catalogue](http://www.festo.com/catalogue) by clicking on the blue button 'Engineering'.

Semi-rotary drives





**Semi-rotary drives  
DRVS**



**Semi-rotary drives  
DRRD**

<b>Size</b>	6, 8, 12, 16, 25, 32, 40	8, 10, 12, 16, 20, 25, 32, 35, 40, 50, 63
<b>Theoretical torque at 6 bar</b>	0.15 ... 20 Nm	0.2 ... 112 Nm
<b>Permissible mass moment of inertia</b>	6.5 ... 350 kgcm <sup>2</sup>	0.0015 ... 42 kgm <sup>2</sup>
<b>Position sensing</b>	Via proximity switch	Via proximity switch
<b>Swivel angle</b>	0 ... 270°	180°
<b>Description</b>	<ul style="list-style-type: none"> <li>• Double-acting semi-rotary drive with vanes</li> <li>• Lighter than other semi-rotary drives</li> <li>• Fixed swivel angle, adjustable swivel angle possible with the help of accessories</li> <li>• Housing protected against splash water and dust</li> </ul>	<ul style="list-style-type: none"> <li>• Twin-piston rotary drive, power transmission via rack and pinion principle</li> <li>• Extremely accurate in the end positions</li> <li>• Very high load-bearing capacity</li> <li>• Very good axial run-out at the flanged shaft</li> </ul>
<b>→ Page/online</b>	<b>42</b>	<b>44</b>

## Drives with slides



	 <b>Mini slides DGST</b>	 <b>Mini slides DGSL</b>
<b>Piston diameter</b>	6 mm, 8 mm, 10 mm, 12 mm, 16 mm, 20 mm, 25 mm	6 mm, 8 mm, 10 mm, 12 mm, 16 mm, 20 mm, 25 mm, 32 mm
<b>Theoretical force at 6 bar, advancing</b>	34 ... 589 N	17 ... 483 N
<b>Stroke</b>	10 ... 200 mm	10 ... 200 mm
<b>Cushioning</b>	Elastomer cushioning, at both ends, stroke not adjustable, elastic cushioning rings/plates at both ends, external hydraulic cushioning	Short elastic cushioning rings/plates at both ends, no cushioning, elastic cushioning rings/plates at both ends, elastic cushioning rings/plates at both ends with fixed stop, shock absorber, self-adjusting, progressive, at both ends, with reducing sleeve, shock absorber, progressive, at both ends
<b>Position sensing</b>	Via proximity switch	Via proximity switch
<b>Description</b>	<ul style="list-style-type: none"> <li>• Powerful twin-piston drive</li> <li>• Shortest mini slide on the market</li> <li>• Precision recirculating ball bearing guide</li> <li>• Versatile mounting options</li> </ul>	<ul style="list-style-type: none"> <li>• High load capacity and positioning accuracy</li> <li>• Maximum movement precision thanks to ground-in ball bearing cage guide</li> <li>• Maximum flexibility thanks to 8 sizes</li> <li>• Reliable in the event of pressure drop thanks to clamping cartridge or end-position locking</li> <li>• Wide variety of mounting and attachment options</li> <li>• Compact design</li> </ul>
<b>→ Page/online</b>	46	<a href="#">dgsL</a>

## Drives with guide rods



	 <b>Guided drives DFM, DFM-B</b>
<b>Piston diameter</b>	6 mm, 10 mm, 12 mm, 16 mm, 20 mm, 25 mm, 32 mm, 40 mm, 50 mm, 63 mm, 80 mm, 100 mm
<b>Theoretical force at 6 bar, advancing</b>	17 ... 4712 N
<b>Stroke</b>	5 ... 400 mm
<b>Cushioning</b>	Elastic cushioning rings/plates at both ends, pneumatic cushioning adjustable at both ends, shock absorber, soft characteristic curve
<b>Position sensing</b>	Via proximity switch
<b>Description</b>	<ul style="list-style-type: none"> <li>• Drive and guide unit in a single housing</li> <li>• High resistance to torques and lateral forces</li> <li>• Plain or recirculating ball bearing guide</li> <li>• Wide variety of mounting and attachment options</li> <li>• Wide range of variants for customised applications</li> </ul>
<b>→ Page/online</b>	48

Product overview

Quarter turn actuators for process automation



	 <b>Quarter turn actuators DFPD</b>	 <b>Quarter turn actuators DAPS</b>
<b>Design</b>	Rack and pinion	Scotch yoke system
<b>Operating mode</b>	Double-acting, single-acting	Double-acting, single-acting
<b>Size of valve actuator</b>	10, 20, 40, 80, 120, 160, 240, 300, 480, 700, 900, 1200, 2300	0008, 0015, 0030, 0053, 0060, 0090, 0106, 0120, 0180, 0240, 0360, 0480, 0720, 0960, 1440, 1920, 2880, 3840, 4000, 5760, 8000
<b>Flange hole pattern</b>	F03, F04, F05, F07, F10, F12, F14, F16, F0507, F0710, F1012, F1216	F03, F04, F05, F07, F10, F12, F14, F16, F25
<b>Swivel angle</b>	90 ... 180°	90 ... 92°
<b>Operating pressure</b>	2 ... 8 bar	1 ... 8.4 bar
<b>Ambient temperature</b>	-50 ... 150°C	-50 ... 150°C
<b>Description</b>	<ul style="list-style-type: none"> <li>• Uniform torque across the full rotation angle range of 90° with the double-acting version</li> <li>• Process valve connection to ISO 5211</li> <li>• Mounting hole pattern to VDI/VDE 3845</li> <li>• Sturdy, non-slip and easy-to-clean aluminium housing</li> <li>• Long service life, low wear</li> <li>• Version with swivel angle 120°, 135°, 180° for the sizes 40, 120, 240, 480, double-acting</li> </ul>	<ul style="list-style-type: none"> <li>• High breakaway torques</li> <li>• Approved in accordance with Directive 2014/34/EU (ATEX)</li> <li>• Flange hole pattern to ISO 5211</li> <li>• Mounting hole pattern to VDI/VDE 3845</li> <li>• Optionally with handwheel as a manual emergency override</li> <li>• Corrosion-resistant, stainless-steel version</li> </ul>
<b>→ Page/online</b>	<b>209</b>	<b>daps</b>

Linear actuators for process automation



	 <b>Linear actuators with displacement encoder DFPI</b>	 <b>Linear actuators with displacement encoder DFPI-NB3</b>
<b>Design</b>	Piston, piston rod, profile barrel, tie rod, cylinder barrel	Piston, piston rod, tie rod, cylinder barrel
<b>Operating mode</b>	Double-acting	Double-acting
<b>Size of valve actuator</b>	100, 125, 160, 200, 250, 320	100, 125, 160, 200, 250, 320
<b>Stroke</b>	40 ... 990 mm	40 ... 990 mm
<b>Flange hole pattern</b>	F07, F10, F14	
<b>Operating pressure</b>	3 ... 8 bar	3 ... 8 bar
<b>Ambient temperature</b>	-20 ... 80°C	-20 ... 80°C
<b>Description</b>	<ul style="list-style-type: none"> <li>• Mounting interfaces for process valves to DIN EN ISO 5210</li> <li>• Integrated air duct</li> <li>• Optionally with integrated displacement encoder or fully integrated positioner</li> <li>• IP65, IP67, IP69K, NEMA4</li> <li>• ATEX certification</li> </ul>	<ul style="list-style-type: none"> <li>• Mounting interfaces to ISO 15552</li> <li>• Sturdy tie rod design</li> <li>• Optionally with integrated displacement encoder or fully integrated positioner</li> <li>• IP65, IP67, IP69K, NEMA4</li> <li>• ATEX certification</li> </ul>
<b>→ Page/online</b>	<b>dfpi</b>	<b>dfpi</b>



## Shock absorbers

	 <b>Shock absorbers DYSS</b>	 <b>Shock absorbers DYEY-Y1, DYEY-Y1F</b>
<b>Stroke</b>	4 ... 12 mm	0.9 ... 7 mm
<b>Max. energy absorption per stroke</b>	0.1 ... 10 J	0.005 ... 1.2 J
<b>Cushioning</b>	Self-adjusting	Elastic cushioning rings/pads on both sides without fixed metal stop
<b>Description</b>	<ul style="list-style-type: none"> <li>Hydraulic shock absorber with path-controlled flow control function</li> <li>Rapidly increasing cushioning force curve</li> <li>Short cushioning stroke</li> <li>Suitable for low-vibration operation</li> <li>External cushioning for mini slide DGST, linear drive DLGF</li> </ul>	<ul style="list-style-type: none"> <li>Mechanical shock absorber with flexible rubber buffer</li> <li>Elastic rubber buffer allows a defined metal end position</li> <li>Adjustable cushioning hardness</li> <li>Ideal for cushioning low energy</li> <li>With precise metal end position</li> <li>As standard design or short design</li> <li>External cushioning for mini slide DGST, DGSL, swivel module DSM-B</li> </ul>
<b>→ Page/online</b>	47	47

## Cylinder mounting parts and accessories for pneumatic drives

	 <b>Mounting attachments</b>	 <b>Piston-rod attachments</b>
<b>Description</b>	<ul style="list-style-type: none"> <li>Mounting kits DARQ d 206</li> <li>Direct mountings</li> <li>Foot mountings → 28, 31, 33, 37, 41, 43</li> <li>Flange mountings → 28, 33</li> <li>Swivel mountings → 33, 35</li> <li>Clevis feet → 28, 31, 33, 35, trunnion supports</li> <li>Slot nuts NST/NSTL</li> <li>Centring pins/sleeves NSTH</li> </ul>	<ul style="list-style-type: none"> <li>Rod clevises SG, CRSG</li> <li>Rod eyes SGS</li> <li>Coupling pieces KSG</li> <li>Self-aligning rod couplers FK</li> <li>Adapters AD</li> </ul>
<b>→ Page/online</b>	n 015001	50

## Customised components – for your specific requirements



### Drives with customised designs

Can't find the pneumatic drive you need in our catalogue?

We can offer you customised components that are tailored to your specific requirements.

Common product modifications:

- Materials for special ambient conditions
- Customised dimensions
- Special strokes
- Customised mounting options
- Implementation of special cylinder functions (cylinder/valve combinations, single-acting principle, etc.)

Many additional variants are possible.

Ask your Festo sales engineer, who will be happy to help:

→ [www.festo.com/contact](http://www.festo.com/contact)

## Self-adjusting end-position cushioning PPS for standards-based cylinders

### More productivity, less work: PPS

Simply ingenious: the unique, self-adjusting end-position cushioning PPS saves huge amounts of time during assembly, adjusts optimally to changes in load and speed and allows the cylinder to move dynamically and gently into the end position. This reduces wear on the entire system.

This and many other advantages are the result of the unique design with longitudinal slots which allow air to escape.

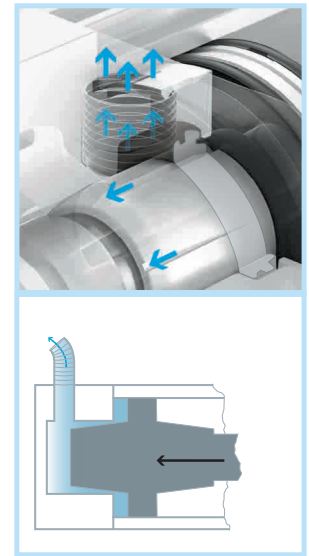
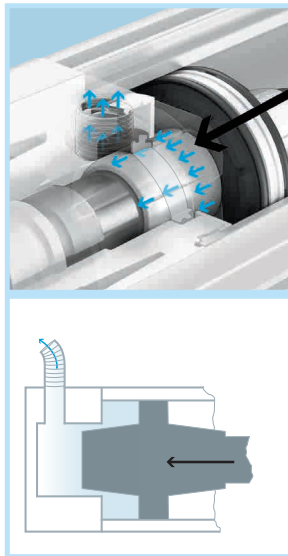
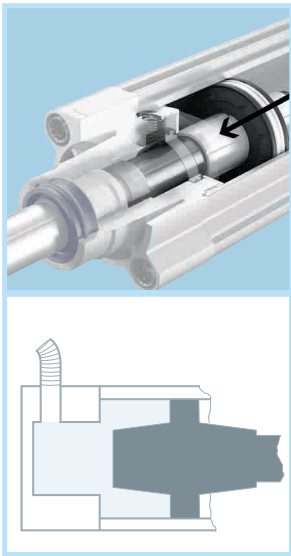

### Use the advantages of PPS – in these cylinders

ADN  
→ 26

DSBC  
→ 29

DSNU  
→ 32

DSNU  
→ 34

DSNU-S  
→ 36



### Software tool

#### Festo Design Tool 3D

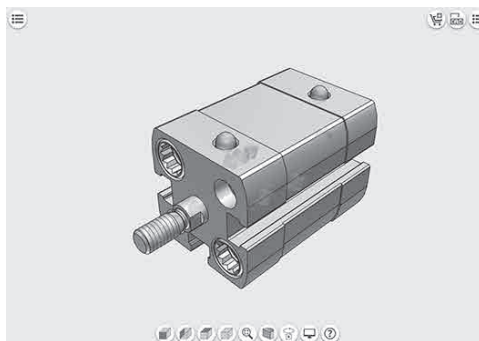

The Festo Design Tool 3D is a 3D product configurator for generating specific CAD product combinations from Festo. The configurator makes your search for the right accessory easier, more reliable and faster.

You can then order the module that has been created as a single order item, either completely pre-assembled or as individual parts in a single box. This considerably reduces your bill of materials, and downstream processes such as product ordering, order picking and assembly are significantly simplified.

All ordering options are available in the following countries:  
AT, BE, CH, CZ, DE, DK, ES, EST, FI, FR, GB, GR, HU, IE, IT, NL, NO, PL, PT, RU, SE, SI, SK, TR, ZA.

This tool can be found

- at: [www.festo.com/fdt-3d-online](http://www.festo.com/fdt-3d-online) in the above listed countries.

## Self-adjusting end-position cushioning PPS for standards-based cylinders

## Less can be more: the advantages of self-adjusting cushioning at a glance

**Less shock**

Running smoothly, Part 1:  
The better the cushioning, the less settling and impact vibration. Better for the cylinder, better for the machine.

**Less time**

Save time and effort in adjusting. The calculation is simple:  
no. of cylinders x 5 mins = time saving.

**Less noise**

Running smoothly, Part 2:  
Where there is no vibration, there is nothing to disturb the working environment of both workers and machines.

**Less errors**

Always correct. All by itself. PPS cushioning prevents setting errors and automatically compensates for changing loads.

**Less adjustment required:**

Goodbye screwdriver. Not just less adjustment, but no adjustment at all! Standards-based cylinders with PPS cushioning are self-adjusting.

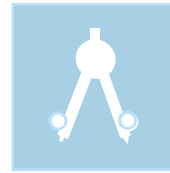
**Less planning**

Making it easy – setting multiple cylinders to run in parallel is a nightmare. Standards-based cylinders with PPS cushioning. Simply fit and forget.

**Less cleaning**

A clean solution. No cushioning screws cuts dust and dirt traps and makes for smoother surfaces. In other words, adjusting-screw-free.

**Less bulky**

Compact cylinders ADN-PPS offer up to 300% more end of stroke energy absorption. Smaller or more powerful, the choice is yours.

**Less variants**

Relaxed purchasing. Cylinders with PPS cushioning have a far wider operating range than most standard cylinders. The result is fewer variants with more application options.

**Less risk**

No screws, no setting on live machinery; safer and faster. And no operator fiddling. Standards-based cylinders with PPS are self-adjusting.

**Less wear**

Self-adjusting means always perfectly set. Perfectly set cushioning means that cylinders operate more smoothly and longer. More machine uptime and greater throughput.

**Less stock**

Less is more. Your finance department will think so too. PPS cushioning enables a narrower range of cylinders to cover the same performance range. And less stock = lower costs.

Cylinders with piston rod > Standards-based cylinders >

## Compact cylinders ADN, to ISO 21287, double-acting ★

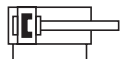
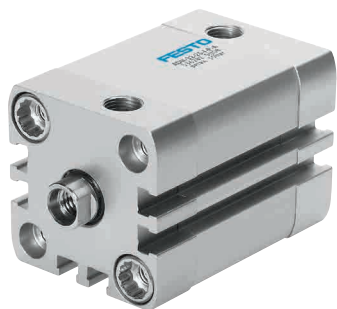

- Compact cylinders with standard dimensions
- Up to 50% less installation space than comparable standards-based cylinders to ISO 15552
- Innovative technology for maximum speeds
- Flexible in use thanks to easy-to-configure variants
- Selected types in accordance with ATEX directive for potentially explosive atmospheres  
→ [www.festo.com/ex](http://www.festo.com/ex)

### Order code – Basic design

001 002 003 004 005 006 007 008 009 010 011 012 013 014 015 016  
**ADN** -  -  -  -  - **A** -  -  -  -  -  -  -  -  -  -  -

001	Type
ADN	Standards-based cylinder, double-acting, based on ISO 21287
002	Piston Ø [mm]
...	12, 16, 20, 25, 32, 40, 50, 63, 80
003	Stroke [mm]
...	5, 10, 15, 20, 25, 30, 40, 50, 60, 80
004	Piston rod thread type
A	Male thread
I	Female thread
005	Cushioning
P	Elastic cushioning rings/plates at both ends
PPS	Pneumatic cushioning, self-adjusting at both ends
006	Position sensing
A	Via proximity switch
007	Protection against rotation
-	None
008	Piston rod type
-	Piston rod at one end

009	Temperature resistance
-	Standard
010	Slow speed
-	None
011	Low friction
-	Standard
012	Increased lateral force
-	None
013	Captive rating plate
-	Rating plate, glued
014	Low temperature
-	None
015	Wiper seal
-	Standard
016	EU certification (ATEX)
-	None

Legend:  Mandatory entry    Optional entry

### Product options

100, 125 mm Piston Ø	S2	Through piston rod	K5	Special piston rod thread	S11	Low friction
1 ... 500 mm Variable stroke	S20	Through, hollow piston rod	K10	Smooth anodised aluminium piston rod	R3	High corrosion protection
Q Square piston rod	K2	Extended male piston rod thread	S6	Heat-resistant seals up to max. 120 °C	R8	Dust protection
K8 Extended piston rod			S10	Slow speed	TL	Laser etched rating plate
S1 Reinforced piston rod					TT	Low temperature
					KP	With clamping unit, attached
					EL...	With end-position locking

Configurable product

This product and all its product options can be ordered online via the configurator:

→ [www.festo.com/catalogue/adn](http://www.festo.com/catalogue/adn)

## Ordering – Basic design

003 Stroke [mm]	002 Piston Ø [mm]								
	12	16	20	25	32	40	50	63	80
004 Piston rod with male thread – 005 Cushioning – 006 Position sensing									
	A – P – A	A – P – A	A – P – A	A – P – A	A – P – A	A – P – A	A – P – A	A – P – A	A – P – A
5	★ 536204	★ 536219	★ 536234	★ 536251	★ 536268	★ 536289	★ 536310		
10	★ 536205	★ 536220	★ 536235	★ 536252	★ 536269	★ 536290	★ 536311	★ 536332	★ 536353
15	★ 536206	★ 536221	★ 536236	★ 536253	★ 536270	★ 536291	★ 536312	★ 536333	★ 536354
20	★ 536207	★ 536222	★ 536237	★ 536254	★ 536271	★ 536292	★ 536313	★ 536334	★ 536355
25	★ 536208	★ 536223	★ 536238	★ 536255	★ 536272	★ 536293	★ 536314	★ 536335	★ 536356
30	★ 536209	★ 536224	★ 536239	★ 536256	★ 536273	★ 536294	★ 536315	★ 536336	★ 536357
40	★ 536210	★ 536225	★ 536240	★ 536257	★ 536274	★ 536295	★ 536316	★ 536337	★ 536358
50		★ 536331	★ 536241	★ 536258	★ 536275	★ 536296	★ 536317	★ 536338	★ 536359
60			★ 536352	★ 536373	★ 536276	★ 536297	★ 536318	★ 536339	★ 536360
80					★ 536277	★ 536298	★ 536319	★ 536340	★ 536361
					A – PPS – A	A – PPS – A	A – PPS – A	A – PPS – A	A – PPS – A
10					★ 572655	★ 572673	★ 572691	★ 572709	★ 572727
15					★ 572656	★ 572674	★ 572692	★ 572710	★ 572728
20					★ 572657	★ 572675	★ 572693	★ 572711	★ 572729
25					★ 572658	★ 572676	★ 572694	★ 572712	★ 572730
30					★ 572659	★ 572677	★ 572695	★ 572713	★ 572731
40					★ 572660	★ 572678	★ 572696	★ 572714	★ 572732
50					★ 572661	★ 572679	★ 572697	★ 572715	★ 572733
60					★ 572662	★ 572680	★ 572698	★ 572716	★ 572734
80					★ 572663	★ 572681	★ 572699	★ 572717	★ 572735
004 Piston rod with female thread – 005 Cushioning – 006 Position sensing									
	I – P – A	I – P – A	I – P – A	I – P – A	I – P – A	I – P – A	I – P – A	I – P – A	I – P – A
5	★ 536211	★ 536226	★ 536242	★ 536259	★ 536278	★ 536299	★ 536320		
10	★ 536212	★ 536227	★ 536243	★ 536260	★ 536279	★ 536300	★ 536321	★ 536342	★ 536363
15	★ 536213	★ 536228	★ 536244	★ 536261	★ 536280	★ 536301	★ 536322	★ 536343	★ 536364
20	★ 536214	★ 536229	★ 536245	★ 536262	★ 536281	★ 536302	★ 536323	★ 536344	★ 536365
25	★ 536215	★ 536230	★ 536246	★ 536263	★ 536282	★ 536303	★ 536324	★ 536345	★ 536366
30	★ 536216	★ 536231	★ 536247	★ 536264	★ 536283	★ 536304	★ 536325	★ 536346	★ 536367
40	★ 536217	★ 536232	★ 536248	★ 536265	★ 536284	★ 536305	★ 536326	★ 536347	★ 536368
50		★ 536341	★ 536249	★ 536266	★ 536285	★ 536306	★ 536327	★ 536348	★ 536369
60			★ 536362	★ 536383	★ 536286	★ 536307	★ 536328	★ 536349	★ 536370
80					★ 536287	★ 536308	★ 536329	★ 536350	★ 536371
					I – PPS – A	I – PPS – A	I – PPS – A	I – PPS – A	I – PPS – A
10					★ 572646	★ 572664	★ 572682	★ 572700	★ 572718
15					★ 572647	★ 572665	★ 572683	★ 572701	★ 572719
20					★ 572648	★ 572666	★ 572684	★ 572702	★ 572720
25					★ 572649	★ 572667	★ 572685	★ 572703	★ 572721
30					★ 572650	★ 572668	★ 572686	★ 572704	★ 572722
40					★ 572651	★ 572669	★ 572687	★ 572705	★ 572723
50					★ 572652	★ 572670	★ 572688	★ 572706	★ 572724
60					★ 572653	★ 572671	★ 572689	★ 572707	★ 572725
80					★ 572654	★ 572672	★ 572690	★ 572708	★ 572726

### P and PPS cushioning

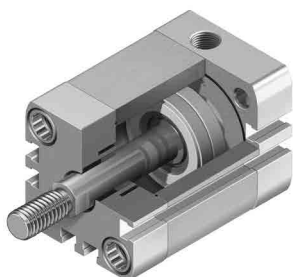

**P cushioning:**  
Elastic cushioning rings/plates at both ends

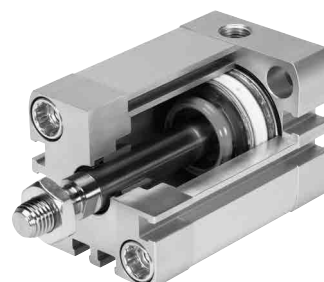

**PPS cushioning:**  
Pneumatic cushioning, self-adjusting at both ends

Cylinders with piston rod > Standards-based cylinders >

Compact cylinders ADN, to ISO 21287, double-acting ★

Accessories

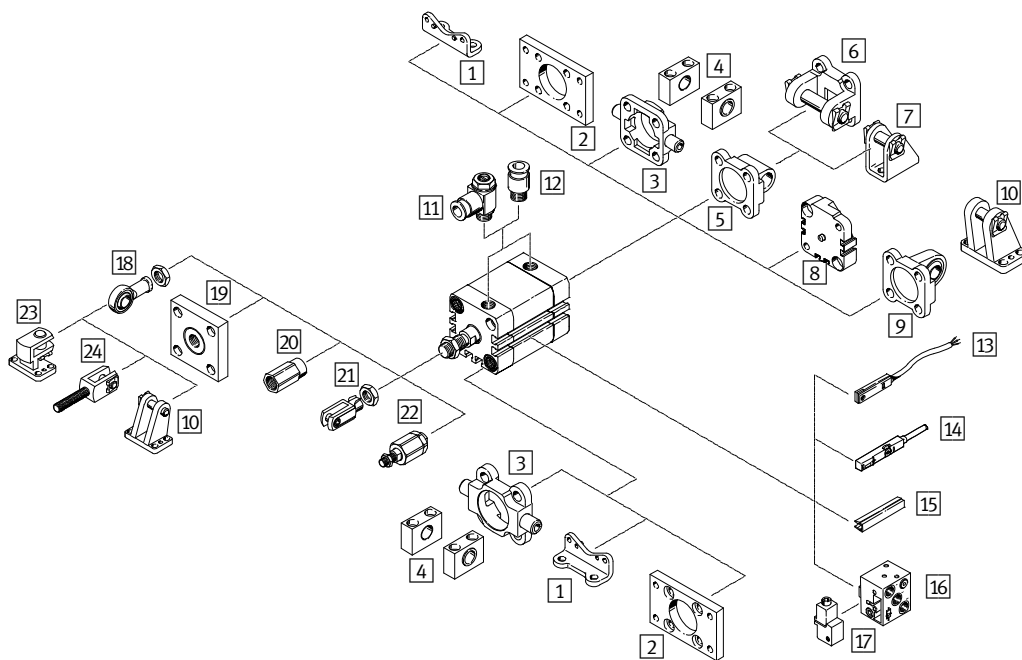

- 1 Foot mounting HNA → 28
- 2 Flange mounting FNC → 28
- 3 Trunnion flange ZNCF → 31
- 4 Trunnion support LNZG → [adn](#)
- 5 Swivel flange SNCL → 28
- 6 Swivel flange SNCB → 28
- 7 Clevis foot LBN → 28
- 8 Multi-position kit DPNA → 28
- 9 Swivel flange SNCS → 28
- 10 Clevis foot LBG → [adn](#)
- 11 One-way flow control valve GRLA/GLRZ → 109
- 12 Push-in fitting QS → 168
- 13 Proximity sensor SME-/SMT-8 → 125  
Connecting cable NEBU → 125

- 14 Proximity sensor SME-/SMT-8M → 125  
Connecting cable NEBU → 125
- 15 Slot cover ABP-5-S → [adn](#)
- 16 Proximity sensor SMPO-8E → [adn](#)

- 17 Mounting kit SMB-8E → [adn](#)
- 18 Rod eye SGS  
For piston Ø 16 ... 80 → 50
- 19 Coupling piece KSG/KSZ → 28
- 20 Adapter AD → [adn](#)
- 21 Rod clevis SG  
For piston Ø 16 ... 80 → 50

- 22 Self-aligning rod coupler FK  
For piston Ø 12 → 28  
For piston Ø 16 ... 80 → 109
- 23 Right-angle clevis foot LQG → 28
- 24 Rod clevis SGA → 28

1 Foot mounting HNA		
For Ø	Type	Part no.
12	HNA-12	537237
16	HNA-16	537238
20	HNA-20	537239
25	HNA-25	537240
32	HNA-32	537241
40	HNA-40	537242
50	HNA-50	537243
63	HNA-63	537244
80	HNA-80	537249

5 Swivel flange SNCL		
For Ø	Type	Part no.
12	SNCL-12	537790
16	SNCL-16	537791
20	SNCL-20	537792
25	SNCL-25	537793
32	SNCL-32	★ 174404
40	SNCL-40	★ 174405
50	SNCL-50	★ 174406
63	SNCL-63	★ 174407
80	SNCL-80	★ 174408

8 Multi-position kit DPNA		
For Ø	Type	Part no.
12	DPNA-12	537263
16	DPNA-16	537264
20	DPNA-20	537265
25	DPNA-25	537266
32	DPNA-32	537267
40	DPNA-40	537268
50	DPNA-50	537269
63	DPNA-63	537270
80	DPNA-80	537271

19 Coupling piece KSZ		
For Ø	Type	Part no.
16	KSZ-M6	36123
20, 25	KSZ-M8	36124
32, 40	KSZ-M10x1,25	36125
50, 63	KSZ-M12x1,25	36126
80	KSZ-M16x1,5	36127

2 Flange mounting FNC		
For Ø	Type	Part no.
12	FNC-12	537245
16	FNC-16	537246
20	FNC-20	537247
25	FNC-25	537248
32	FNC-32	★ 174376
40	FNC-40	★ 174377
50	FNC-50	★ 174378
63	FNC-63	★ 174379
80	FNC-80	★ 174380

6 Swivel flange SNCB		
For Ø	Type	Part no.
32	SNCB-32	★ 174390
40	SNCB-40	★ 174391
50	SNCB-50	★ 174392
63	SNCB-63	★ 174393
80	SNCB-80	★ 174394

9 Swivel flange SNCS		
For Ø	Type	Part no.
32	SNCS-32	★ 174397
40	SNCS-40	★ 174398
50	SNCS-50	★ 174399
63	SNCS-63	★ 174400
80	SNCS-80	★ 174401

22 Self-aligning rod coupler FK		
For Ø	Type	Part no.
12	FK-M5	30984

7 Clevis foot LBN		
For Ø	Type	Part no.
12, 16	LBN-12/16	★ 6058
20, 25	LBN-20/25	★ 6059

19 Coupling piece KSG		
For Ø	Type	Part no.
32, 40	KSG-M10x1,25	32963
50, 63	KSG-M12x1,25	32964
80	KSG-M16x1,5	32965

23 Right-angle clevis foot LQG		
For Ø	Type	Part no.
32, 40	LQG-32	31768
50, 63	LQG-40	31769
80	LQG-50	31770

24 Rod clevis SGA		
For Ø	Type	Part no.
32, 40	SGA-M10x1,25	32954
50, 63	SGA-M12x1,25	10767
80	SGA-M16x1,25	10768

## Standards-based cylinders DSBC, to ISO 15552, double-acting ★

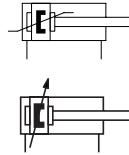

- Strokes of up to 2800 mm
- Excellent flexibility thanks to wide range of variants
- Extensive range of accessories makes it possible to install the cylinder virtually anywhere

- Selected types in accordance with ATEX directive for potentially explosive atmospheres

→ [www.festo.com/ex](http://www.festo.com/ex)

## Order code – Basic design

001 002 003 004 005 006 007 008 009 010  
 DSBC - - - - - - - A - N3

Legend:  Mandatory entry  Optional entry

001	Type
DSBC	Standards-based cylinder, double-acting, based on ISO 15552
002	Protection against rotation
-	Without protection against rotation
003	Running characteristics
-	Standard
004	Piston Ø [mm]
...	32, 40, 50, 63, 80
005	Stroke [mm]
...	20, 25, 30, 40, 50, 60, 70, 80, 100, 125, 150, 160, 200, 250, 300, 320, 400, 500
006	Piston rod type
-	At one end

007	Piston rod thread type
-	Male thread
008	Cushioning
PPV	Pneumatic cushioning, adjustable at both ends
PPS	Pneumatic cushioning, self-adjusting at both ends
009	Position sensing
A	Via proximity switch
010	Standard
N3	Conforms to ISO 15552

## Product options

100, 125 mm Piston Ø	E1	End-position locking at both ends	D3	Sensor slot on 3 sides	A1	Increased chemical resistance
1 ... 2800 mm Variable stroke			P	Elastic cushioning rings/ plates both ends	A2	Hard scraper
Q With protection against rotation	E2	End-position locking with advanced piston rod	R3	High corrosion protection	A3	Suitable for unlubricated operation
L Running characteristic low friction	E3	End-position locking with retracted piston rod	T1	Heat-resistant seals up to max. 120 °C	A6	Metal scraper
U Uniformly slow movement	T	Through piston rod	T3	Low temperature	EX4	EU certification (II 2GD)
L1 Low friction for balancer applications	F	Female piston rod thread	T4	Heat-resistant seals up to max. 150 °C	...E	Extended piston rod
C Clamping unit attached			P2	Bellows on bearing cap	...L	Extended piston rod thread
						Standard: based on ISO 15552

 Configurable product

This product and all its product options can be ordered online via the configurator:

→ [www.festo.com/catalogue/dsbc](http://www.festo.com/catalogue/dsbc)

Cylinders with piston rod > Standards-based cylinders >

Standards-based cylinders DSBC, to ISO 15552, double-acting ★

Ordering – Basic design

005 Stroke [mm]	004 Piston Ø [mm]					004 Piston Ø [mm]				
	32	40	50	63	80	32	40	50	63	80
	008 Cushioning – 009 Position sensing – 010 Conforms to ISO 15552									
	PPVA	PPVA	PPVA	PPVA	PPVA	PPS A	PPS A	PPS A	PPS A	PPS A
20	★ 2123069	★ 2123166	★ 2098969	★ 2125490	★ 2126594	★ 2123085	★ 2123780	★ 2102628	★ 2126684	★ 2126636
25	★ 1376422	★ 1376656	★ 1366948	★ 1383578	★ 1383333	★ 1376467	★ 1376903	★ 1376301	★ 1383632	★ 1383366
30	★ 2123070	★ 2123167	★ 2098970	★ 2125491	★ 2126595	★ 2123086	★ 2123781	★ 2102629	★ 2126685	★ 2126637
40	★ 1376423	★ 1376657	★ 1366949	★ 1383579	★ 1383334	★ 1376468	★ 1376904	★ 1376304	★ 1383633	★ 1383367
50	★ 1376424	★ 1376658	★ 1366950	★ 1383580	★ 1383335	★ 1376469	★ 1376905	★ 1376305	★ 1383634	★ 1383368
60	★ 2123071	★ 2123224	★ 2098972	★ 2125492	★ 2126597	★ 2123087	★ 2123782	★ 2102630	★ 2126686	★ 2126638
70	★ 2123072	★ 2123225	★ 2098973	★ 2125493	★ 2126598	★ 2123088	★ 2123783	★ 2102631	★ 2126687	★ 2126639
80	★ 1376425	★ 1376659	★ 1366951	★ 1383581	★ 1383336	★ 1376470	★ 1376906	★ 1376306	★ 1383635	★ 1383369
100	★ 1376426	★ 1376660	★ 1366952	★ 1383582	★ 1383337	★ 1376471	★ 1376907	★ 1376307	★ 1383636	★ 1383370
125	★ 1376427	★ 1376661	★ 1366953	★ 1383583	★ 1383338	★ 1376472	★ 1376908	★ 1376308	★ 1383637	★ 1383371
150	★ 2123073	★ 2123226	★ 2098974	★ 2125494	★ 2126599	★ 2123089	★ 2123784	★ 2102632	★ 2126688	★ 2126640
160	★ 1376428	★ 1376662	★ 1366954	★ 1383584	★ 1383339	★ 1376473	★ 1376909	★ 1376309	★ 1383638	★ 1383372
200	★ 1376429	★ 1376663	★ 1366955	★ 1383585	★ 1383340	★ 1376474	★ 1376910	★ 1376310	★ 1383639	★ 1383373
250	★ 1376430	★ 1376664	★ 1366956	★ 1383586	★ 1383341	★ 1376475	★ 1376911	★ 1376311	★ 1383640	★ 1383374
300	★ 2123074	★ 2123227	★ 2098975	★ 2125495	★ 2126600	★ 2123090	★ 2123785	★ 2102633	★ 2126689	★ 2126641
320	★ 1376431	★ 1376665	★ 1366957	★ 1383587	★ 1383342	★ 1376476	★ 1376912	★ 1376312	★ 1383641	★ 1383375
400	★ 1376432	★ 1376666	★ 1366958	★ 1383588	★ 1383343	★ 1376477	★ 1376913	★ 1376313	★ 1383642	★ 1383376
500	★ 1376433	★ 1376667	★ 1366959	★ 1383589	★ 1383344	★ 1376478	★ 1376914	★ 1376314	★ 1383643	★ 1383377

Accessories

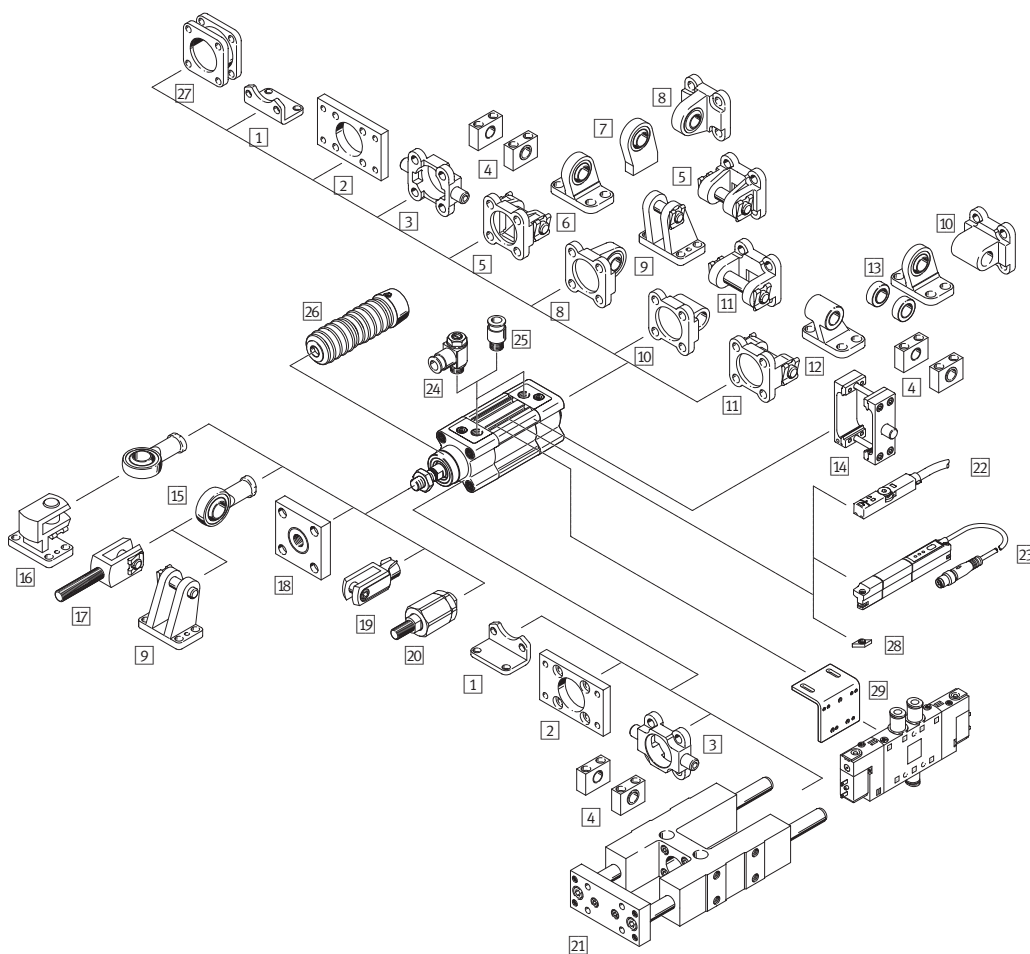

- 1 Foot mounting HNC → 31
- 2 Flange mounting FNC → 31  
Trunnion flange ZNCF d 31
- 4 Trunnion support LNZG → 31
- 5 Swivel flange SNC → 31
- 6 Clevis foot LSNG → dsbc
- 7 Clevis foot LSNSG → dsbc
- 8 Swivel flange SNCS → 31
- 9 Clevis foot LBG → dsbc
- 10 Swivel flange SNCL → 31
- 11 Swivel flange SNCB → 31
- 12 Clevis foot LNG → 31
- 13 Clevis foot LSN → dsbc
- 14 Trunnion mounting kit DAMT → 31
- 15 Rod eye SGS → 51
- 16 Right-angle clevis foot LQG → 31
- 17 Rod clevis SGA → 31
- 18 Coupling piece KSG/KSZ → 31
- 19 Rod clevis SG → 51
- 20 Self-aligning rod coupler FK → 51
- 21 Guide unit FENG → dsbc
- 22 Proximity sensor SME-/SMT-8M → 125  
Connecting cable NEBU → 125

- 23 Position transmitter SMAT, SDAT → dsbc
- 24 One-way flow control valve GRLA → 109

- 25 Push-in fitting QS → 168
- 26 Bellows kit DADB → dsbc

- 27 Multi-position kit DPNC → 31
- 28 Slot nut ABAN → dsbc

- 29 Mounting kit DAVM → dsbc  
Slot cover ABP-5-S → dsbc



## Accessories

1 Foot mounting HNC/CRHNC<sup>1)</sup>

For Ø	Type	Part no.	Type	Part no.
32	HNC-32	★ 174369	CRHNC-32	176937
40	HNC-40	★ 174370	CRHNC-40	176938
50	HNC-50	★ 174371	CRHNC-50	176939
63	HNC-63	★ 174372	CRHNC-63	176940
80	HNC-80	★ 174373	CRHNC-80	176941

1) CRHNC: high corrosion protection

2 Flange mounting FNC/CRFNG<sup>2)</sup>

For Ø	Type	Part no.	Type	Part no.
32	FNC-32	★ 174376	CRFNG-32	161846
40	FNC-40	★ 174377	CRFNG-40	161847
50	FNC-50	★ 174378	CRFNG-50	161848
63	FNC-63	★ 174379	CRFNG-63	161849
80	FNC-80	★ 174380	CRFNG-80	161850

2) CRFNG: high corrosion protection

## 3 Trunnion flange ZNCF

For Ø	Type	Part no.
32	ZNCF-32	174411
40	ZNCF-40	174412
50	ZNCF-50	174413
63	ZNCF-63	174414
80	ZNCF-80	174415

## 4 Trunnion support LNZG

For Ø	Type	Part no.
32	LNZG-32	32959
40	LNZG-40/50	32960
50	LNZG-40/50	32960
63	LNZG-63/80	32961
80	LNZG-63/80	32961

## 5 Swivel flange SNC

For Ø	Type	Part no.
32	SNC-32	★ 174383
40	SNC-40	★ 174384
50	SNC-50	★ 174385
63	SNC-63	★ 174386
80	SNC-80	★ 174387

## 8 Swivel flange SNCS

For Ø	Type	Part no.
32	SNCS-32	★ 174397
40	SNCS-40	★ 174398
50	SNCS-50	★ 174399
63	SNCS-63	★ 174400
80	SNCS-80	★ 174401

## 10 Swivel flange SNCL

For Ø	Type	Part no.
32	SNCL-32	★ 174404
40	SNCL-40	★ 174405
50	SNCL-50	★ 174406
63	SNCL-63	★ 174407
80	SNCL-80	★ 174408

11 Swivel flange SNCB/SNCB-R3<sup>3)</sup>

For Ø	Type	Part no.	Type	Part no.
32	SNCB-32	★ 174390	SNCB-32-R3	176944
40	SNCB-40	★ 174391	SNCB-40-R3	176945
50	SNCB-50	★ 174392	SNCB-50-R3	176946
63	SNCB-63	★ 174393	SNCB-63-R3	176947
80	SNCB-80	★ 174394	SNCB-80-R3	176948

3) SNCB-R3: high corrosion protection

## 12 Clevis foot LNG

For Ø	Type	Part no.
32	LNG-32	★ 33890
40	LNG-40	★ 33891
50	LNG-50	★ 33892
63	LNG-63	★ 33893
80	LNG-80	★ 33894

## 14 Trunnion mounting kit DAMT

For Ø	Type	Part no.
32	DAMT-V1-32-A	★ 2213233
40	DAMT-V1-40-A	★ 2214899
50	DAMT-V1-50-A	★ 2214909
63	DAMT-V1-63-A	★ 2214971
80	DAMT-V1-80-A	★ 163529

## 16 Right-angle clevis foot LQG

For Ø	Type	Part no.
32	LQG-32	31768
40	LQG-40	31769
50	LQG-50	31770
63	LQG-63	31771
80	LQG-80	31772

## 17 Rod clevis SGA

For Ø	Type	Part no.
32	SGA-M10x1,25	32954
40	SGA-M12x1,25	10767
50	SGA-M16x1,5	10768
63	SGA-M16x1,5	10768
80	SGA-M20x1,5	10769

## 18 Coupling piece KSG/KSZ

For Ø	Type	Part no.	Type	Part no.
32	KSG-M10x1,25	32963	KSZ-M10x1,25	36125
40	KSG-M12x1,25	32964	KSZ-M12x1,25	36126
50, 63	KSG-M16x1,5	32965	KSZ-M16x1,5	36127
80	KSG-M20x1,5	32966	KSZ-M20x1,5	36128

## 27 Multi-position kit DPNC

For Ø	Type	Part no.
32	DPNC-32	174418
40	DPNC-40	174419
50	DPNC-50	174420
63	DPNC-63	174421
80	DPNC-80	174422

Cylinders with piston rod > Standards-based cylinders >

## Round cylinders DSNU, to ISO 6432, double-acting ★

Pneumatic drives

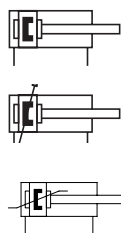

- Diameter 8 ... 25 mm: ISO 6432
- For very high demands on running characteristics, service life and load capacity
- Universal use thanks to individual variants
- Comprehensive range of accessories
- Selected types in accordance with ATEX directive for potentially explosive atmospheres  
→ [www.festo.com/ex](http://www.festo.com/ex)

### Order code – Basic design

001	002	003	004	005
DSNU	-	-	-	-A

Legend:  Mandatory entry     Optional entry

001	Type
DSNU	Standards-based cylinder, double-acting
002	Piston Ø [mm]
...	12, 16, 20, 25
003	Stroke [mm]
...	10, 15, 20, 25, 30, 35, 40, 50, 60, 70, 80, 100, 125, 150, 160, 200, 250, 300, 320

004	Cushioning
P	Elastic cushioning rings/plates at both ends
PPV	Pneumatic cushioning adjustable at both ends
PPS	Pneumatic cushioning, self-adjusting at both ends
005	Position sensing
A	Via proximity switch

### Product options

8, 10 mm Piston Ø	Q	With protection against rotation	KP	With clamping unit	K6	Shortened male piston rod thread
1 ... 500 mm Variable stroke	S2	Through piston rod	K2	Extended male piston rod thread	K8	Extended piston rod
MQ Alternative plain cylinder end cap, lateral connection	S6	Heat-resistant seals up to max. 120 °C	K3	Female piston rod thread	R3	High corrosion protection
MA Alternative plain cylinder end cap, axial connection	S10	Slow speed	K5	Special piston rod thread	R8	Dust protection (scraper)
MH Alternative cylinder end cap, direct mounting	S11	Low friction			A6	Metal scraper
					KP	Clamping unit on the piston rod



Configurable product

This product and all its product options can be ordered online via the configurator:

→ [www.festo.com/catalogue/dsnu](http://www.festo.com/catalogue/dsnu)

## Ordering – Basic design

003 Stroke [mm]	002 Piston Ø [mm]								002 Piston Ø [mm]											
	12		16		20		25		16		20		25							
	004 Cushioning – 005 Position sensing																			
	P – A		P – A		P – A		P – A		PPV – A		PPV – A		PPV – A							
10	★	19189	★	19198	★	19207	★	19218	★	1908266	★	1908289	★	1908312	★	1908274	★	1908297	★	1908320
15	★	1908255	★	1908259	★	1908282	★	1908305	★	1908267	★	1908290	★	1908313	★	1908275	★	1908298	★	1908321
20	★	1908256	★	1908260	★	1908283	★	1908306	★	1908268	★	1908291	★	1908314	★	1908276	★	1908299	★	1908322
25	★	19190	★	19199	★	19208	★	19219	★	33973	★	33974	★	33975	★	559263	★	559271	★	559282
30	★	1908257	★	1908261	★	1908284	★	1908307	★	1908269	★	1908292	★	1908315	★	1908277	★	1908300	★	1908323
35			★	1908262	★	1908285	★	1908308	★	1908270	★	1908293	★	1908316	★	1908278	★	1908301	★	1908324
40	★	19191	★	19200	★	19209	★	19220	★	19229	★	19236	★	19245	★	559264	★	559272	★	559283
50	★	19192	★	19201	★	19210	★	19221	★	19230	★	19237	★	19246	★	559265	★	559273	★	559284
60	★	1908258	★	1908263	★	1908286	★	1908309	★	1908271	★	1908294	★	1908317	★	1908279	★	1908302	★	1908325
70			★	1908264	★	1908287	★	1908310	★	1908272	★	1908295	★	1908318	★	1908280	★	1908303	★	1908326
80	★	19193	★	19202	★	19211	★	19222	★	19231	★	19238	★	19247	★	559266	★	559274	★	559285
100	★	19194	★	19203	★	19212	★	19223	★	19232	★	19239	★	19248	★	559267	★	559275	★	559286
125	★	19195	★	19204	★	19213	★	19224	★	19233	★	19240	★	19249	★	559268	★	559276	★	559287
150			★	1908265	★	1908288	★	1908311	★	1908273	★	1908296	★	1908319	★	1908281	★	1908304	★	1908327
160	★	19196	★	19205	★	19214	★	19225	★	19234	★	19241	★	19250	★	559269	★	559277	★	559288
200	★	19197	★	19206	★	19215	★	19226	★	19235	★	19242	★	19251	★	559270	★	559278	★	559289
250					★	19216	★	19227			★	19243	★	19252			★	559279	★	559290
300					★	19217	★	19228			★	19244	★	19253			★	559280	★	559291
320					★	34718	★	34719			★	34720	★	34721			★	559281	★	559292

## Accessories

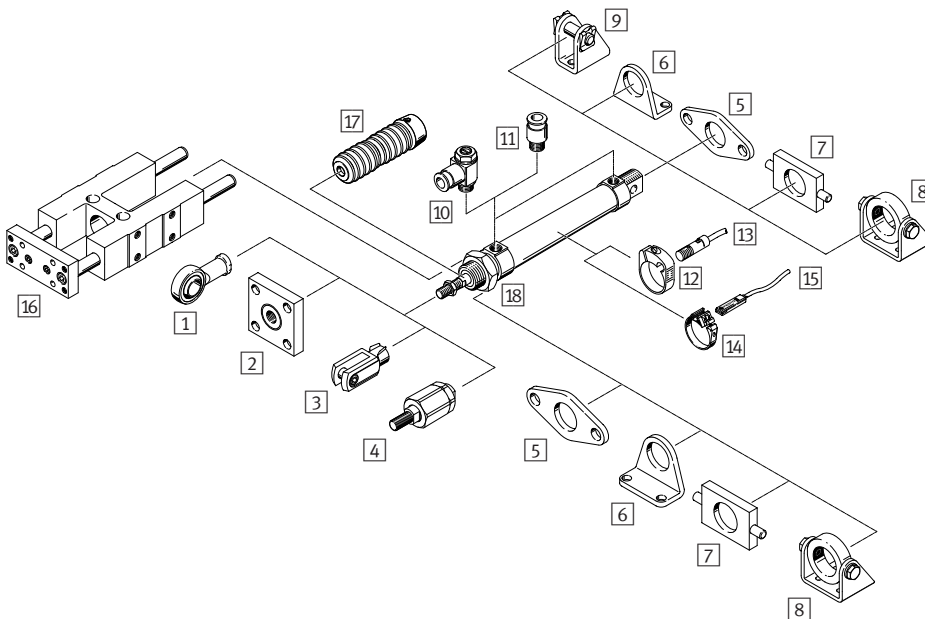

- 1 Rod eye SGS → 51
- 2 Coupling piece KSG/KSZ → 33
- 3 Rod clevis SG → 51
- 4 Self-aligning rod coupler FK → 51
- 5 Flange mounting FBN → 33
- 6 Foot mounting HBN → 33
- 7 Swivel mounting WBN → 33
- 8 Swivel mounting SBN → 33
- 9 Clevis foot LBN → 33
- 10 One-way flow control valve GRLA/GRLZ → 109
- 11 Push-in fitting QS → 168
- 12 Mounting kit SMBR → dsnu

- 13 Proximity sensor SMEO-/SMT0-4U → dsnu
- 14 Mounting kit SMBR-8 → 126
- 15 Proximity sensor SME-/SMT-8M → 125
- 16 Guide unit FEN → dsnu
- 17 Bellows kit DADB → dsnu
- 18 Hex nut MSK → 33

2 Coupling piece KSG		
For Ø	Type	Part no.
25	KSG-M10x1,25	32963

2 Coupling piece KSZ		
For Ø	Type	Part no.
12,16	KSZ-M6	36123
20	KSZ-M8	36124
25	KSZ-M10x1,25	36125

5 Flange mounting FBN		
For Ø	Type	Part no.
12, 16	FBN-12/16	5130
20, 25	FBN-20/25	5131

6 Foot mounting HBN <sup>1)</sup>		
For Ø	Type	Part no.
12, 16	HBN-12/16x1	★ 5125
	HBN-12/16x2	★ 5126
20, 25	HBN-20/25x1	★ 5127
	HBN-20/25x2	★ 5128

7 Swivel mounting WBN		
For Ø	Type	Part no.
12, 16	WBN-12/16	8609
20, 25	WBN-20/25	8610

8 Swivel mounting SBN		
For Ø	Type	Part no.
20, 25	SBN-20/25	539927

9 Clevis foot LBN		
For Ø	Type	Part no.
12, 16	LBN-12/16	★ 6058
20, 25	LBN-20/25	★ 6059

18 Hex nut MSK		
For Ø	Type	Part no.
16	MSK-M16x1,5	189007
20, 25	MSK-M22x1,5	189009

1) ...x1: 1x foot; ...x2: 2x foot, 1x nut

Piston rod cylinders > Round cylinders >

Round cylinders DSNU, double-acting ★

Pneumatic drives

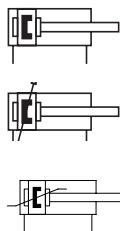

- For very high demands on running characteristics, service life and load capacity
- Universal use thanks to individual variants
- Comprehensive range of accessories
- Selected types in accordance with ATEX directive for potentially explosive atmospheres  
→ [www.festo.com/ex](http://www.festo.com/ex)

Order code – Basic design

001	002	003	004	005
DSNU	-	-	-	- A

Legend:  Mandatory entry

001	Type
DSNU	Round cylinder, double-acting
002	Piston Ø [mm]
...	32
003	Stroke [mm]
...	10, 15, 20, 30, 60, 70, 150, 300

004	Cushioning
P	Elastic cushioning rings/plates at both ends
PPV	Pneumatic cushioning adjustable at both ends
PPS	Pneumatic cushioning, self-adjusting at both ends
005	Position sensing
A	Via proximity switch

Product options

40, 50, 63 mm Piston Ø	Q	With protection against rotation	KP	With clamping unit	K6	Shortened male piston rod thread
1 ... 500 mm Variable stroke	S2	Through piston rod	K2	Extended male piston rod thread	K8	Extended piston rod
MQ Alternative plain cylinder end cap, lateral connection	S6	Heat-resistant seals up to max. 120 °C	K3	Female piston rod thread	R3	High corrosion protection
MA Alternative plain cylinder end cap, axial connection	S10	Slow speed	K5	Special piston rod thread	R8	Dust protection (scraper)
MH Alternative cylinder end cap, direct mounting	S11	Low friction			A6	Metal scraper
					KP	Clamping unit on the piston rod

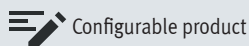

Configurable product

This product and all its product options can be ordered online via the configurator:

→ [www.festo.com/catalogue/dsnu](http://www.festo.com/catalogue/dsnu)

Ordering – Basic design

003 Stroke [mm]	002 Piston Ø [mm]	002 Piston Ø [mm]	002 Piston Ø [mm]
	32	32	32
	004 Cushioning – 005 Position sensing	004 Cushioning – 005 Position sensing	004 Cushioning – 005 Position sensing
	P – A	PPV – A	PPS – A
10	★ 5249365		
15	★ 5249366		
20	★ 5249367		
30	★ 5249368	★ 5249851	★ 5249968
60	★ 5249369	★ 5249853	★ 5249970
70	★ 5249370	★ 5249854	★ 5249971
150	★ 5249371	★ 5249855	★ 5249972
300	★ 5249372	★ 5249856	★ 5249973

## Accessories

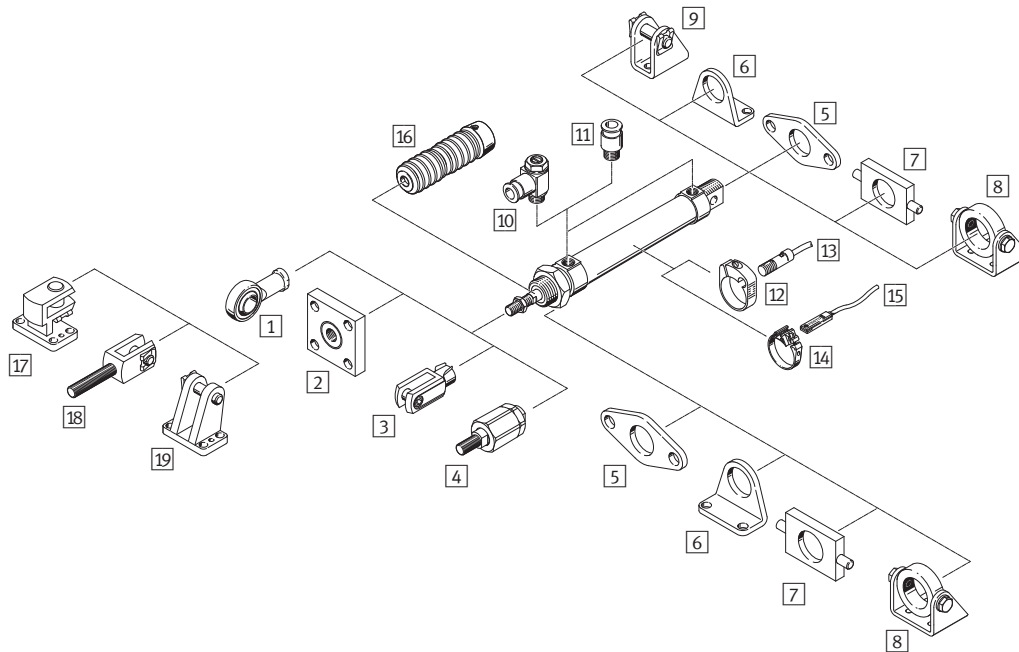

- 1 Rod eye SGS → 50
- 2 Coupling piece KSG/KSZ → 35
- 3 Rod clevis SG → 50  
Self-aligning rod coupler FK d 50
- 5 Flange mounting FBN → 35
- 6 Foot mounting HBN → 35
- 7 Swivel mounting WBN → 35
- 8 Swivel mounting SBN → 35
- 9 Clevis foot LBN → 35
- 10 One-way flow control valve GRLA/  
GRLZ → 109
- 11 Push-in fitting QS → 168
- 12 Mounting kit SMBR → [dsnu](#)

13 Proximity sensor SMEO-/SMT0-4U  
→ [dsnu](#)

15 Proximity sensor SME-/SMT-8M  
→ 125  
Connecting cable NEBU → 125

16 Bellows kit DADB → [dsnu](#)  
17 Right-angle clevis foot LQG  
→ 35

19 Clevis foot LBG → 35

14 Mounting kit SMBR-8 → 126

18 Rod clevis SGA → 35

2 Coupling piece KSG		
For Ø	Type	Part no.
32	KSG-M10x1,25	32963

6 Foot mounting HBN <sup>1)</sup>		
For Ø	Type	Part no.
32	HBN-32x2	195851

9 Clevis foot LBN		
For Ø	Type	Part no.
32	LBN-32	195860

19 Clevis foot LBG		
For Ø	Type	Part no.
32	LBG-32	31761

2 Coupling piece KSZ		
For Ø	Type	Part no.
32	KSZ-M10x1,25	36125

1) ...x2: 2x foot, 1x nut

7 Swivel mounting WBN		
For Ø	Type	Part no.
32	WBN-32	195863

17 Right-angle clevis foot LQG		
For Ø	Type	Part no.
32	LQG-32	31768

5 Flange mounting FBN		
For Ø	Type	Part no.
32	FBN-32	195855

8 Swivel mounting SBN		
For Ø	Type	Part no.
32	SBN-32	539924

18 Rod clevis SGA		
For Ø	Type	Part no.
32	SGA-M10x1,25	32954

Piston rod cylinders > Round cylinders >

Round cylinders DSNU-S, double-acting ★

Pneumatic drives

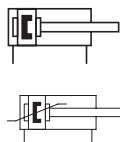

- Compact variant of standards-based cylinder DSNU
- Piston Ø 8... 25 mm
- Stroke 10 ... 200 mm

Order code – Basic design

001 002 003 004 005 006  
**DSNU** - **S** -  -  -  - **A**

Legend:  Mandatory entry

001	Type
DSNU	Round cylinder, double-acting
002	Version
S	Compact
003	Piston Ø [mm]
...	8, 12, 16, 20, 25

004	Stroke [mm]
...	10, 15, 20, 25, 30, 40, 50, 60, 80, 100, 125, 150, 200
005	Cushioning
P	Elastic cushioning rings/plates at both ends
PPS	Pneumatic cushioning, self-adjusting at both ends
006	Position sensing
A	Via proximity switch

Product options

1 ... 200 mm Variable stroke



Configurable product

This product and all its product options can be ordered online via the configurator:

→ [www.festo.com/catalogue/dsnu](http://www.festo.com/catalogue/dsnu)

Ordering – Basic design

004 Stroke [mm]	003 Piston Ø [mm]					003 Piston Ø [mm]		
	8	12	16	20	25	16	20	25
	005 Cushioning – 006 Position sensing					005 Cushioning – 006 Position sensing		
	P – A	P – A	P – A	P – A	P – A	PPS – A	PPS – A	PPS – A
10	★ 5205897	★ 5211896	★ 5216087	★ 5224633	★ 5228227			
15	★ 5205898	★ 5211897	★ 5216088	★ 5224634	★ 5228228			
20	★ 5205899	★ 5211898	★ 5216089	★ 5224635	★ 5228229			
25	★ 5205900	★ 5211899	★ 5216090	★ 5224636	★ 5228230	★ 5217238	★ 5225836	★ 5228452
30	★ 5205902	★ 5211900	★ 5216091	★ 5224637	★ 5228231	★ 5217239	★ 5225837	★ 5228453
40	★ 5205903	★ 5211901	★ 5216093	★ 5224639	★ 5228232	★ 5217240	★ 5225838	★ 5228454
50	★ 5205904	★ 5211903	★ 5216094	★ 5224641	★ 5228233	★ 5217241	★ 5225839	★ 5228455
60	★ 5205905	★ 5211904	★ 5216095	★ 5224642	★ 5228234	★ 5217242	★ 5225840	★ 5228456
80	★ 5205906	★ 5211905	★ 5216096	★ 5224643	★ 5228235	★ 5217243	★ 5225841	★ 5228457
100	★ 5205907	★ 5211906	★ 5216098	★ 5224644	★ 5228236	★ 5217244	★ 5225842	★ 5228458
125		★ 5211908	★ 5216099	★ 5224645	★ 5228237	★ 5217245	★ 5225843	★ 5228459
150		★ 5211909	★ 5216100	★ 5224646	★ 5228238	★ 5217246	★ 5225844	★ 5228460
200			★ 5216101	★ 5224647	★ 5228239	★ 5217248	★ 5225846	★ 5228461

Accessories

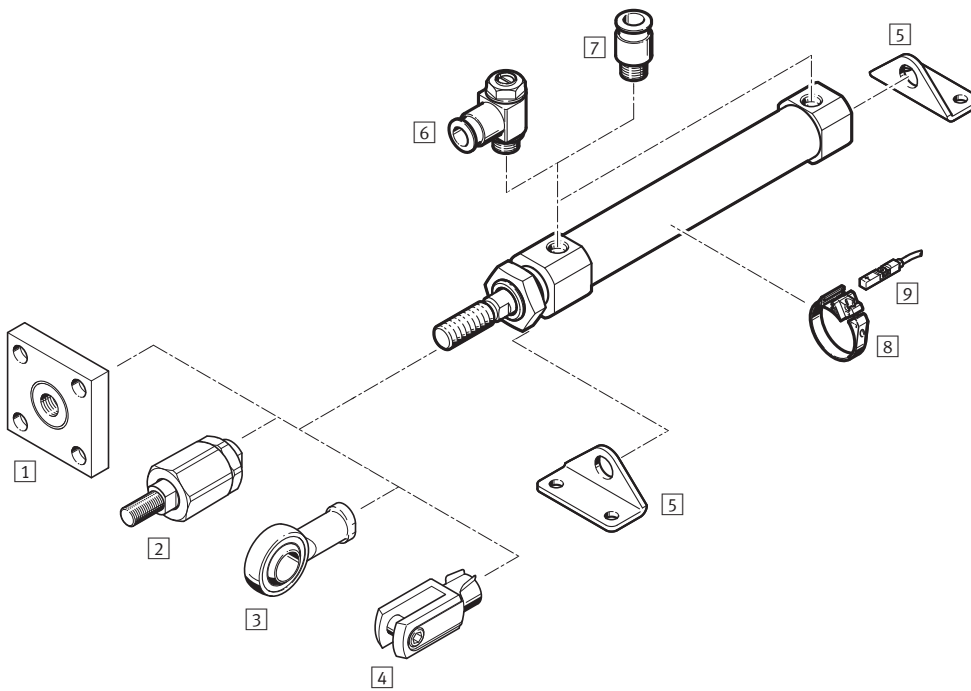

- 1 Coupling piece KSG/KSZ → 37
- 2 Self-aligning rod coupler FK → 50
- 3 Rod eye SGS → 50
- 4 Rod clevis SG → 50
- 5 Foot mounting HBN-S → 37
- 6 One-way flow control valve GRLA/GRLZ → 109
- 7 Push-in fitting QS → 168
- 8 Mounting kit SMBR-8 → 126
- 9 Proximity sensor SME-/SMT-8M → 125  
Connecting cable NEBU → 125

1 Coupling piece KSG		
For Ø	Type	Part no.
25	KSG-M10x1,25	32963

1 Coupling piece KSZ		
For Ø	Type	Part no.
12, 16	KSZ-M6	36123
20	KSZ-M8	36124
25	KSZ-M10x1,25	36125

5 Foot mounting HBN-S <sup>1)</sup>		
For Ø	Type	Part no.
8	HBN-S-8x1	★ 5407712
12, 16	HBN-S-12/16x1	★ 5407772
20, 25	HBN-S-20/25x1	★ 5407787
	HBN-S-20/25x2	★ 5407847

1) ...x1: . 1x foot; ...x2: 2x foot, 1x nut

Cylinders with piston rod > Compact, short-stroke and flat cylinders >

Compact cylinders ADN-S, double-acting ★

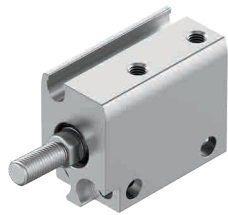

- Extremely small and lightweight
- Perfect for micro-movements
- Improved running characteristics thanks to precise manufacturing from a single piece
- Wide range of mounting options, interfaces from two sides

Order code

001 002 003 004 005 006 007  
ADN - S - - - I - - -

Legend:  Mandatory entry  Optional entry

001	Type
ADN	Compact cylinder, double-acting
002	Design
S	Short
003	Piston Ø [mm]
...	6, 10
004	Stroke [mm]
...	5, 10

005	Piston rod thread
I	Female thread
006	Cushioning
-	Without cushioning
007	Position sensing
-	None
A	Via proximity switch

Product options

AEN Single-acting compact cylinder      A Male thread

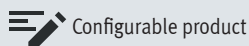

Configurable product

This product and all its product options can be ordered online via the configurator:

→ [www.festo.com/catalogue/adn-s](http://www.festo.com/catalogue/adn-s)

Ordering – ADN-S, double-acting

004 Stroke [mm]	003 Piston Ø [mm]	
	6	10
	<b>005 Piston rod with female thread I</b>	
	006 Without cushioning – 007 Without position sensing	
	I	I
5	★ 4886885	★ 4887523
10	★ 4886886	★ 4887524
	006 Without cushioning – 007 With position sensing	
	I – A	I – A
5	★ 5173732	★ 5177082
10	★ 5173733	★ 5177085

Accessories

Proximity sensor SME-/SMT-10M → 127

Connecting cable NEBU → 127



Short-stroke cylinders ADVC, AEVC, double-acting/single-acting ★

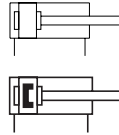

- High clamping forces in a compact size
- Mounting hole pattern to ISO 15552 from piston Ø 32 mm
- Application-oriented housing and piston rod variants
- Supply ports and profile slot for proximity sensors on one side

Order code – Basic design

001 002 003 004 005 006  
 -  -  -  -  -

Legend:  Mandatory entry  Optional entry

001	Type
ADVC	Short-stroke cylinder, double-acting
AEVC	Short-stroke cylinder, single-acting
002	Piston Ø [mm]
...	12, 16, 20, 25, 32, 40, 50, 63
003	Stroke [mm]
...	5, 10, 15, 20, 25

004	Piston rod thread
A	Male thread
I	Female thread
005	Cushioning
P	Elastic cushioning rings/plates at both ends
006	Position sensing
-	None
A	Via proximity switch

Product options

4, 6, 10, 80, 100 mm Piston Ø – without piston rod thread  
 2.5 ... 25 mm stroke

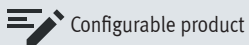

Configurable product

This product and all its product options can be ordered online via the configurator:

→ [www.festo.com/catalogue/advc](http://www.festo.com/catalogue/advc)

Ordering – Basic design AEVC, single-acting

003 Stroke [mm]	002 Piston Ø [mm]							
	12	16	20	25	32	40	50	63
	004 Piston rod with male thread – 005 Cushioning – 006 Without position sensing							
	A – P	A – P	A – P	A – P	A – P	A – P	A – P	A – P
5	★ 188086	★ 188105	★ 188137	★ 188169	★ 188201			
10	★ 188087	★ 188106	★ 188138	★ 188170	★ 188202	★ 188230	★ 188258	★ 188282
25		★ 188107	★ 188139	★ 188171	★ 188203	★ 188231	★ 188259	★ 188283
	004 Piston rod with female thread – 005 Cushioning – 006 Without position sensing							
	I – P	I – P	I – P	I – P	I – P	I – P	I – P	I – P
5	★ 188082	★ 188099	★ 188131	★ 188163	★ 188195			
10	★ 188083	★ 188100	★ 188132	★ 188164	★ 188196	★ 188226	★ 188254	★ 188278
25		★ 188101	★ 188133	★ 188165	★ 188197	★ 188227	★ 188255	★ 188279

Cylinders with piston rod > Compact, short-stroke and flat cylinders >

Short-stroke cylinders ADVC, AEVC, double-acting/single-acting ★

Ordering – Basic design ADVC, double-acting

003 Stroke [mm]	002 Piston Ø [mm]							
	12	16	20	25	32	40	50	63
	004 Piston rod with male thread – 005 Cushioning – 006 Without position sensing							
	A – P	A – P	A – P	A – P	A – P	A – P	A – P	A – P
5	★ 188094	★ 188123	★ 188155	★ 188187	★ 188219	★ 188247		
10	★ 188095	★ 188124	★ 188156	★ 188188	★ 188220	★ 188248	★ 188272	★ 188296
15		★ 188125	★ 188157	★ 188189	★ 188221	★ 188249	★ 188273	★ 188297
20		★ 188126	★ 188158	★ 188190	★ 188222	★ 188250	★ 188274	★ 188298
25		★ 188127	★ 188159	★ 188191	★ 188223	★ 188251	★ 188275	★ 188299
	004 Piston rod with female thread – 005 Cushioning – 006 Without position sensing							
	I – P	I – P	I – P	I – P	I – P	I – P	I – P	I – P
5	★ 188090	★ 188113	★ 188145	★ 188177	★ 188209	★ 188237		
10	★ 188091	★ 188114	★ 188146	★ 188178	★ 188210	★ 188238	★ 188264	★ 188288
15		★ 188115	★ 188147	★ 188179	★ 188211	★ 188239	★ 188265	★ 188289
20		★ 188116	★ 188148	★ 188180	★ 188212	★ 188240	★ 188266	★ 188290
25		★ 188117	★ 188149	★ 188181	★ 188213	★ 188241	★ 188267	★ 188291
	004 Piston rod with male thread – 005 Cushioning – 006 Position sensing via proximity sensor							
	A – P – A	A – P – A	A – P – A	A – P – A	A – P – A	A – P – A	A – P – A	A – P – A
5	★ 188092	★ 188118	★ 188150	★ 188182	★ 188214	★ 188242		
10	★ 188093	★ 188119	★ 188151	★ 188183	★ 188215	★ 188243	★ 188268	★ 188292
15		★ 188120	★ 188152	★ 188184	★ 188216	★ 188244	★ 188269	★ 188293
20		★ 188121	★ 188153	★ 188185	★ 188217	★ 188245	★ 188270	★ 188294
25		★ 188122	★ 188154	★ 188186	★ 188218	★ 188246	★ 188271	★ 188295
	004 Piston rod with female thread – 005 Cushioning – 006 Position sensing via proximity sensor							
	I – P – A	I – P – A	I – P – A	I – P – A	I – P – A	I – P – A	I – P – A	I – P – A
5	★ 188088	★ 188108	★ 188140	★ 188172	★ 188204	★ 188232		
10	★ 188089	★ 188109	★ 188141	★ 188173	★ 188205	★ 188233	★ 188260	★ 188284
15		★ 188110	★ 188142	★ 188174	★ 188206	★ 188234	★ 188261	★ 188285
20		★ 188111	★ 188143	★ 188175	★ 188207	★ 188235	★ 188262	★ 188286
25		★ 188112	★ 188144	★ 188176	★ 188208	★ 188236	★ 188263	★ 188287

Accessories

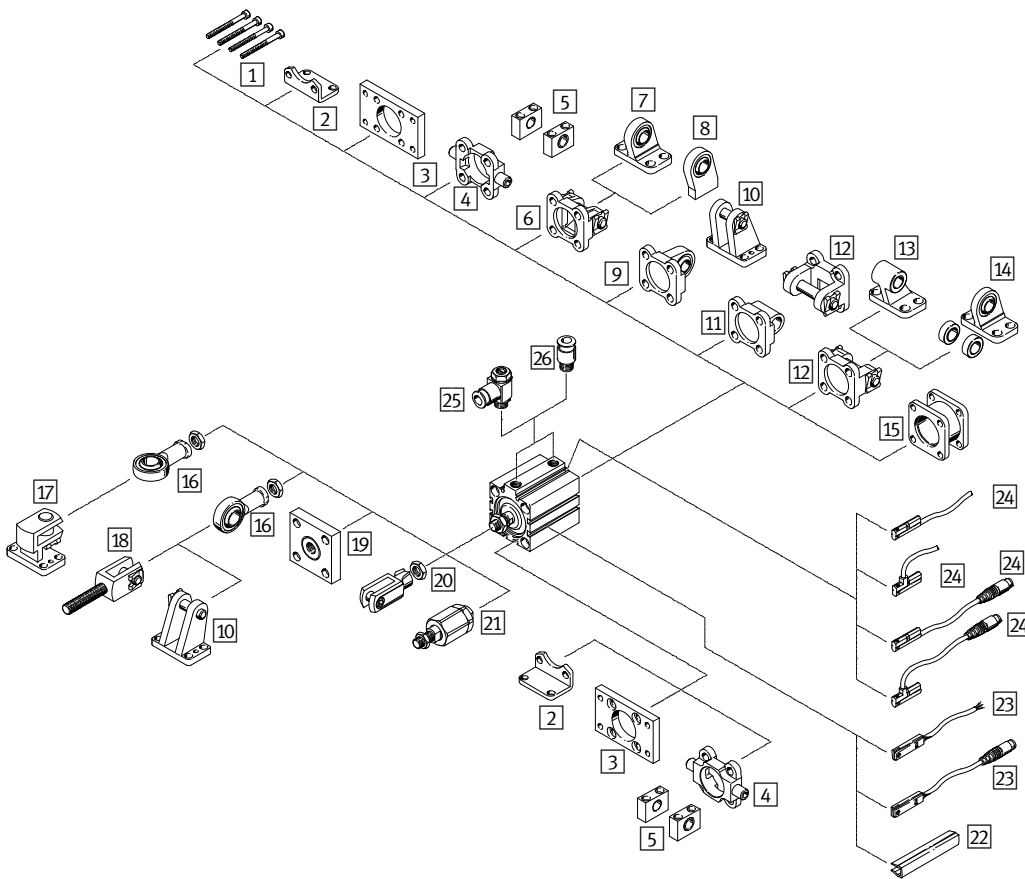

- 1 Mounting screws (not included in the scope of delivery)
- 2 Foot mounting HNC → 41
- 3 Flange mounting FNC → 41
- 4 Trunnion flange ZNCF → 41
- 5 Trunnion support LNZG → 41
- 6 Swivel flange SNC → 41
- 7 Clevis foot LSNG → advc
- 8 Clevis foot LSNSG → advc
- 9 Swivel flange SNCS → 41
- 10 Clevis foot LBG → advc
- 11 Swivel flange SNCL → 41
- 12 Swivel flange SNCB → 41
- 13 Clevis foot LNG → 41
- 14 Clevis foot LSN → advc
- 15 Multi-position kit DPNC → 41
- 16 Rod eye SGS → 50
- 17 Right-angle clevis foot LQG → 41
- 18 Rod clevis SGA → 41
- 19 Coupling piece KSG → 41
- 20 Rod clevis SG → 50
- 21 Self-aligning rod coupler FK → 50

22 Slot cover ABP-5-S → advc

23 Proximity switches SME-/SMT-8M → 125  
Connecting cable NEBU → 125

24 Proximity switches SME-/SMT-10M → 127  
Connecting cable NEBU → 127

25 One-way flow control valve GRLA → 109

26 Push-in fitting QS → 168

2 Foot mounting HNC			
For Ø	Type	Part no.	
32	HNC-32	★	174369
40	HNC-40	★	174370
50	HNC-50	★	174371
63	HNC-63	★	174372

5 Trunnion support LNZG			
For Ø	Type	Part no.	
32	LNZG-32		32959
40, 50	LNZG-40/50		32960
63	LNZG-63/80		32961

11 Swivel flange SNCL			
For Ø	Type	Part no.	
32	SNCL-32	★	174404
40	SNCL-40	★	174405
50	SNCL-50	★	174406
63	SNCL-63	★	174407

15 Multi-position kit DPNC			
For Ø	Type	Part no.	
32	DPNC-32		174418
40	DPNC-40		174419
50	DPNC-50		174420
63	DPNC-63		174421

3 Flange mounting FNC			
For Ø	Type	Part no.	
32	FNC-32	★	174376
40	FNC-40	★	174377
50	FNC-50	★	174378
63	FNC-63	★	174379

6 Swivel flange SNC			
For Ø	Type	Part no.	
32	SNC-32	★	174383
40	SNC-40	★	174384
50	SNC-50	★	174385
63	SNC-63	★	174386

12 Swivel flange SNCB			
For Ø	Type	Part no.	
32	SNCB-32	★	174390
40	SNCB-40	★	174391
50	SNCB-50	★	174392
63	SNCB-63	★	174393

17 Right-angle clevis foot LQG			
For Ø	Type	Part no.	
32, 40	LQG-32		31768
50, 63	LQG-40		31769

4 Trunnion flange ZNCF			
For Ø	Type	Part no.	
32	ZNCF-32		174411
40	ZNCF-40		174412
50	ZNCF-50		174413
63	ZNCF-63		174414

9 Swivel flange SNCS			
For Ø	Type	Part no.	
32	SNCS-32	★	174397
40	SNCS-40	★	174398
50	SNCS-50	★	174399
63	SNCS-63	★	174400

13 Clevis foot LNG			
For Ø	Type	Part no.	
32	LNG-32	★	33890
40	LNG-40	★	33891
50	LNG-50	★	33892
63	LNG-63	★	33893

18 Rod clevis SGA			
For Ø	Type	Part no.	
32, 40	SGA-M10x1,25		32954
50, 63	SGA-M12x1,25		10767

19 Coupling piece KSG			
For Ø	Type	Part no.	
32, 40	KSG-M10x1,25		32963
50, 63	KSG-M12x1,25		32964

Semi-rotary drives > Semi-rotary drives with vane >

## Semi-rotary drives DRVS, double-acting ★

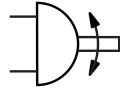

- Modern and compact design
- Lighter than other semi-rotary drives
- Housing protected against splash water and dust
- Selected types in accordance with ATEX directive for potentially explosive atmospheres  
→ [www.festo.com/ex](http://www.festo.com/ex)

### Order code – Basic design

001 002 003 004 005  
**DRVS** -  -  - **P** -

Legend:  Mandatory entry  Optional entry

001	Type
DRVS	Semi-rotary drive, double-acting
002	Size
...	6, 8, 12, 16, 25, 32, 40
003	Nominal swivel angle [°]
...	90, 180, 270

004	Cushioning
P	Elastic cushioning rings/plates at both ends
005	EU certification
-	None

### Product options

EX4 EU certification (II 2GD)

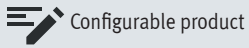

This product and all its product options can be ordered online via the configurator:

→ [www.festo.com/catalogue/drvs](http://www.festo.com/catalogue/drvs)

### Ordering – Basic design

003 Nominal swivel angle [°]	002 Size						
	6	8	12	16	25	32	40
90	004 Elastic cushioning rings/plates at both ends						
	P	P	P	P	P	P	P
180	★ 1845706	★ 1845708	★ 1845710	★ 1845713	★ 1845716	★ 1845719	★ 1845722
270	★ 1845707	★ 1845709	★ 1845711	★ 1845714	★ 1845717	★ 1845720	★ 1845723
			★ 1845712	★ 1845715	★ 1845718	★ 1845721	★ 1845724

## Accessories

Sizes: 6, 8

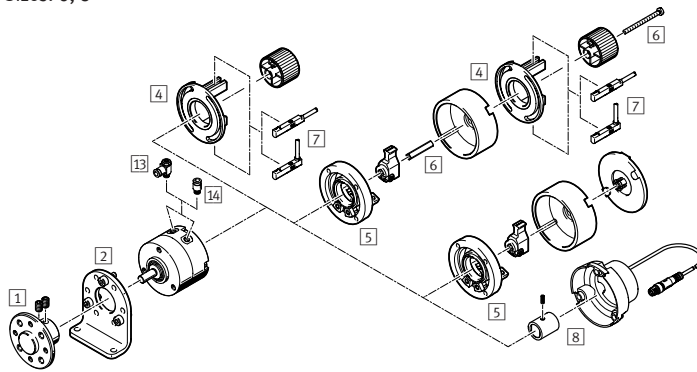

- 1 Push-on flange FWSR/  
DARF → [drvs](#)
- 2 Foot mounting DAMH<sup>1)</sup> → 43
- 3 Flange mounting DAMF → [drvs](#)
- 4 Mounting kit  
WSM-...-SME-10 → 43
- 5 Stop kit KSM → 43
- 6 Adapter kit DADP-AK → 43
- 7 Proximity switch SME/SMT-10  
→ 127
- 8 Position sensor SRBS → 129
- 9 Stop kit DADP-ES → 43

Size 12 ... 40

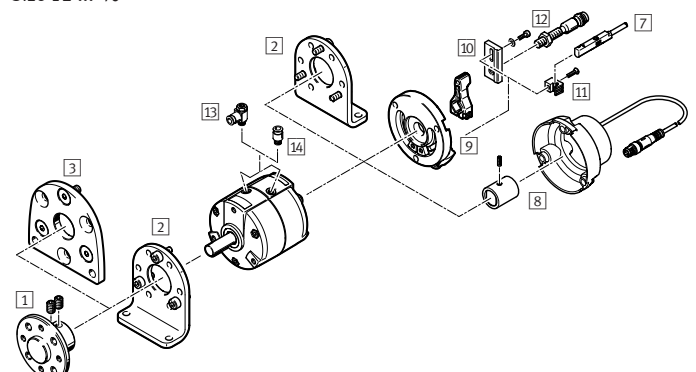

- 10 Sensor bracket SL-DSM-S → [drvs](#)
- 11 Sensor bracket SL-DSM-B → [drvs](#)
- 12 Proximity switch SIEN → 43  
Connecting cable NEBU → 43
- 13 One-way flow control valve GRLA  
Size 6, 8 → 43  
Size 12 ... 40 → 109
- 14 Push-in fitting QS → 168

1) Size 6, 8: The foot mounting can only be mounted at the front.

2 Foot mounting DAMH		
For size	Type	Part no.
6	DAMH-Q12-6	3371840
8	DAMH-Q12-8	3371841
12	DAMH-Q12-12	3371842
16	DAMH-Q12-16	3371843
25	DAMH-Q12-25	3371844
32	DAMH-Q12-32	3371845
40	DAMH-Q12-40	3371846

4 Mounting kit WSM		
For size	Type	Part no.
6	WSM-6-SME-10	173205
8	WSM-8-SME-10	173206

5 Stop kit KSM		
For size	Type	Part no.
6	KSM-6	175833
8	KSM-8	175834

6 Adapter kit DADP-AK		
For size	Type	Part no.
6	DADP-AK-Q1-6	3617044
8	DADP-AK-Q1-8	3617045

9 Stop kit DADP-ES		
For size	Type	Part no.
12	DADP-ES-Q12-12	2536502
16	DADP-ES-Q12-16	2536503
25	DADP-ES-Q12-25	2536504
32	DADP-ES-Q12-32	2536505
40	DADP-ES-Q12-40	2536506

12 Inductive proximity sensor SIEN			
For size	Connection right	Type	Part no.
N/O, M5			
12 ... 40	PNP, cable, 2.5 m	SIEN-M5B-PS-K-L	★ 150370
	PNP, plug	SIEN-M5B-PS-S-L	★ 150371
N/C, M5			
12 ... 40	PNP, cable, 2.5 m	SIEN-M8B-PS-K-L	★ 150386
	PNP, plug	SIEN-M8B-PS-S-L	★ 150387

12 Connecting cable NEBU			
Cable length	Connection right	Type	Part no.
Connection left: straight socket, M8x1, 3-pin			
2.5 m	Cable, open end, 3-wire	NEBU-M8G3-K-2.5-LE3	★ 541333
		NEBU-M8G3-K-5-LE3	★ 541334
Connection left: angled socket, M8x1, 3-pin			
2.5 m	Cable, open end, 3-wire	NEBU-M8W3-K-2.5-LE3	★ 541338
		NEBU-M8W3-K-5-LE3	★ 541341

13 One-way flow control valves GRLA		
For size	Type	Part no.
6, 8	GRLA-M3-QS-3	175041

Semi-rotary drives > Semi-rotary drives with rack and pinion >

## Twin-piston semi-rotary drives DRRD, double-acting ★

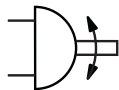

- Extremely accurate in the end positions
- Very high load-bearing capacity
- Very good axial run-out at the flanged shaft
- Very high mass moments of inertia
- Selected types in accordance with ATEX directive for potentially explosive atmospheres  
→ [www.festo.com/ex](http://www.festo.com/ex)

### Order code – Basic design

001	002	003	004	005	006
DRRD	-	180	-	FH	-
					A

Legend:  Mandatory entry

001	Type
DRRD	Semi-rotary drive, double-acting
002	Size
...	16, 20, 25, 32, 35, 40
003	Nominal swivel angle
180	180°
004	Output shaft
FH	Flanged shaft, hollow

005	Cushioning
P	Elastic cushioning rings/plates at both ends
Y9	Linear shock absorber, self-adjusting at both ends
006	Position sensing
A	Via proximity switch

### Product options

8, 10, 12, 50, 63 Sizes	P2E2	Energy through-feed: pneumatic, 2 ducts; electric, 2 signals	Y10	Cushioning: linear shock absorber, self-adjusting at both ends, hard, internal	PS1	1 intermediate position
P2 Energy through-feed: pneumatic, 2 ducts	P4E6	Energy through-feed: pneumatic, 4 ducts; electric, 6 signals	Y12	Cushioning: linear shock absorber, self-adjusting at both ends, external	E1	End-position locking at both ends
P4 Energy through-feed: pneumatic, 4 ducts	P8E8	Energy through-feed: pneumatic, 8 ducts; electric, 8 signals	Y14	Linear shock absorber, self-adjusting at both ends, soft	R	Sensor mounting, external: mounting rail for proximity sensor
P8 Energy through-feed: pneumatic, 8 ducts			EX4	EU certification (II 2 GD)	SG	Splash-proof design
					DN	Without operating instructions



Configurable product

This product and all its product options can be ordered online via the configurator:

→ [www.festo.com/catalogue/drrd](http://www.festo.com/catalogue/drrd)

### Ordering – Basic design

005 Elastic cushioning at both ends P		
002 Size	Type	Part no.
16	DRRD-16-180-FH-PA	★ 1577238
20	DRRD-20-180-FH-PA	★ 1395606
25	DRRD-25-180-FH-PA	★ 1359980
32	DRRD-32-180-FH-PA	★ 1578512
35	DRRD-35-180-FH-PA	★ 1526825
40	DRRD-40-180-FH-PA	★ 1503269

005 Linear shock absorber, self-adjusting at both ends, internal Y9		
002 Size	Type	Part no.
16	DRRD-16-180-FH-Y9A	★ 1644389
20	DRRD-20-180-FH-Y9A	★ 1427379
25	DRRD-25-180-FH-Y9A	★ 1360248
32	DRRD-32-180-FH-Y9A	★ 1578518
35	DRRD-35-180-FH-Y9A	★ 1547102
40	DRRD-40-180-FH-Y9A	★ 1526986

Accessories

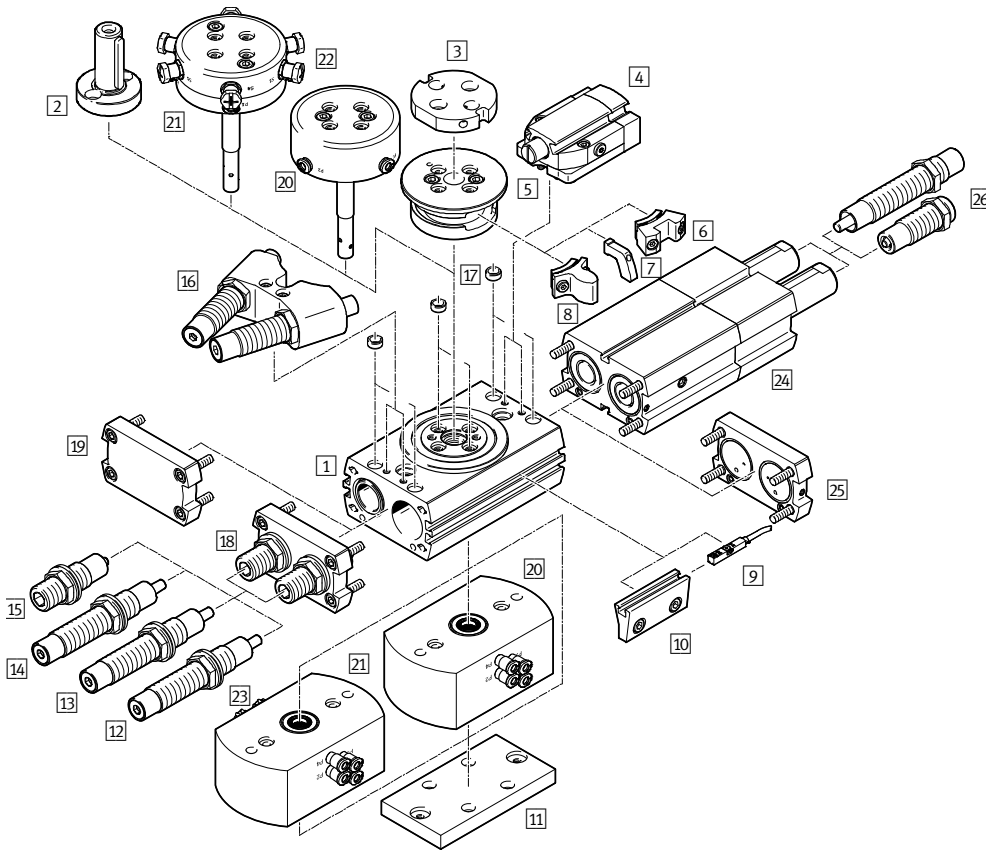

- 1 Semi-rotary drive DRRD → 44
- 2 Drive shaft DARF-Q11 → drrd
- 3 Adapter kit DHAA-G for gripper → drrd
- 4 Clamping unit DADL-...-EL, included in the scope of delivery: 4, 5, 2x6 → drrd  
End-position locking, product option E1
- 5 Flange assembly for mounting components 6, 7 and 8
- 6 Clamping component DADL-EC → drrd
- 5 Drive shaft DARF-Q11 → drrd
- 7 Switch lug DASI-...-SL → drrd
- 8 Stop element, product option Y12
- 9 Proximity sensor SMT-/SME-8M → 125  
Position transmitter SMAT-8M → drrd

- 10 Sensing kit DASI-...-KT → drrd  
Included in the scope of delivery: 5, 2x7, 2x10  
Sensor mounting, product option R
- 11 Adapter kit DHAA-D for drives → drrd
- 12 Shock absorber, product option Y9
- 13 Shock absorber, hard, product option Y10
- 14 Shock absorber, soft, product option Y14
- 15 Shock absorber, product option P
- 16 Shock absorber, external, product option Y12, included in the scope of delivery: 5, 2x8, 16
- 17 Centring sleeve ZBH → drrd
- 18 End cap: in combination with elastic cushioning P or shock absorber Y9, Y10, Y14
- 19 End cap: in combination with external shock absorber Y12
- 20 Energy through-feed, pneumatic, product option P2, P4, P8
- 21 Energy through-feed, pneumatic/electric, product option P2E2, P4E6, P8E8
- 22 Connecting cable NEBU from the energy through-feed to the proximity sensor → 45
- 23 Connecting cable NEBU from the energy through-feed to the controller → 45
- 24 Intermediate position, product option PS1
- 25 Connection cap for supply ports
- 26 Shock absorber DYSC-Y1F → drrd

One-way flow control valve  
For size 16<sup>1)</sup> ... 25 GRLA-M5-QS-3, GLRLA-M5-QS4 → 45, 109  
For size 32 ... 40 → 45  
1) Strongly recommended for this size.

22/23 Connecting cable NEBU, input			
Cable length	Connection right	Type	Part no.
For size 16/20, connection left: straight socket, M8x1, 3-pin			
2.5 m	Cable, open end, 3-wire	NEBU-M8G3-K-2.5-LE3	★ 541333
5 m		NEBU-M8G3-K-5-LE3	★ 541334
For size 25/32/35, connection left: straight socket, M8x1, 4-pin			
2.5 m	Cable, open end, 4-wire	NEBU-M8G4-K-2.5-LE4	541342
5 m		NEBU-M8G4-K-5-LE4	541343
For size 40, connection left:			
2.5 m	Cable, open end, 4-wire	NEBU-M12G5-K-2.5-LE4	★ 550326
5 m		NEBU-M12G5-K-5-LE4	★ 541328

One-way flow control valve GRLA		
For size	Type	Part no.
To set the swivel speed		
16 <sup>1)</sup> , 20, 25	GRLA-M5-QS-3-RS-D	★ 197576
	GRLA-M5-QS-4-RS-D	★ 197577
32, 35, 40	GRLA-1/8-RS-B	151169

1) Strongly recommended for this size.

Drives with guides > Drives with slides >

## Mini slides DGST, double-acting ★

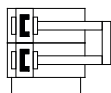

- Very compact design
- Shortest mini slide on the market
- Powerful twin-piston drive
- Very precise recirculating ball bearing guide
- Yoke plate and slide manufactured from a single piece
- Easy end-position adjustment
- Short cycle times and high effective force with twin piston
- High precision and robustness

### Order code

001 002 003 004 005  
 DGST -  -  - E1 A

Legend:  Mandatory entry

001	Type
DGST	Mini slide, double-acting
002	Piston Ø [mm]
...	8, 10, 12, 16, 20
003	Stroke [mm]
...	10, 20, 30, 40, 50, 80, 100

004	Cushioning
E1	Elastomer cushioning, at both ends, stroke not adjustable
005	Position sensing
A	Via proximity switch

### Product options

6, 25 Sizes  
 125, 150, 200 mm Stroke

Cushioning  
 P Elastic cushioning rings/  
 plates both ends  
 Y12 Linear shock absorber,  
 self-adjusting at both ends,  
 external

Configurable product

This product and all its product options can be ordered online via the configurator:

→ [www.festo.com/catalogue/dgst](http://www.festo.com/catalogue/dgst)

### Ordering

003 Stroke [mm]	002 Piston Ø [mm]				
	8	10	12	16	20
	004 Cushioning E1: elastomer cushioning, at both ends, stroke not adjustable – 005 Position sensing A: via proximity sensor				
10	★ 8078833	★ 8078839	★ 8078846	★ 8078853	★ 8078862
20	★ 8078834	★ 8078840	★ 8078847	★ 8078854	★ 8078863
30	★ 8078835	★ 8078841	★ 8078848	★ 8078855	★ 8078864
40	★ 8078836	★ 8078842	★ 8078849	★ 8078856	★ 8078865
50	★ 8078837	★ 8078843	★ 8078850	★ 8078857	★ 8078866
80	★ 8078838	★ 8078844	★ 8078851	★ 8078858	★ 8078867
100		★ 8078845	★ 8078852	★ 8078859	★ 8078868



## Accessories

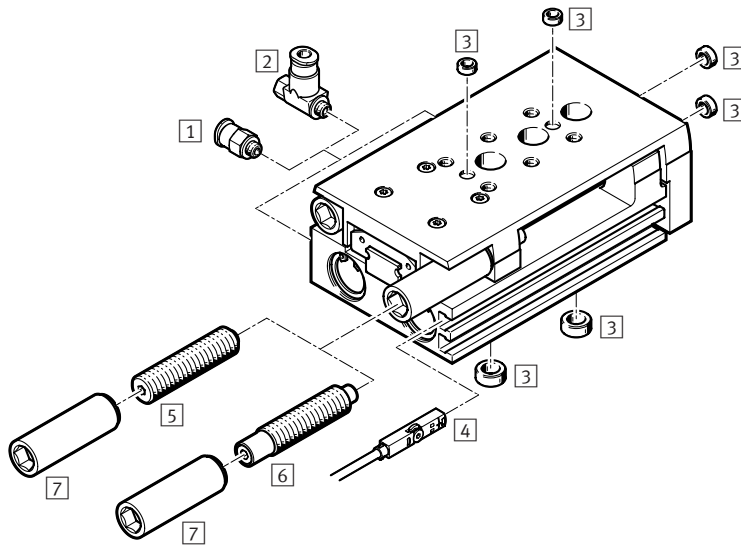

- 1 Push-in fitting QSM → 47, 166
- 2 One-way flow control valve GRLA → 47, 109
- 3 Centring sleeve ZBH → 47
- 4 Proximity sensor SMT-10M/SMT-8M → 127/125  
Position transmitter SMAT-8M/SDAT → [dgst](#)
- 5 Shock absorber DYEF (included in the scope of delivery of the mini slide DGST-P) → 47
- 6 Shock absorber DYSS (included in the scope of delivery of the mini slide DGST-Y12) → 47
- 7 Threaded sleeve included in the scope of delivery of the shock absorber 5/6

**1 Push-in fitting QSM**

For piston Ø [mm]	Type	Part no.
For connecting compressed air tubing with standard outside diameters		
8, 10, 12, 16	QSM-M5-4	★ 153304
20, 25	QSM-1/8-6	★ 153307

**2 One-way flow control valve GRLA**

For piston Ø [mm]	Type	Part no.
For regulating speed		
8, 10, 12, 16	GRLA-M5-QS-6-D	★ 193139
20	GRLA-1/8-QS-8-D	★ 193145

**3 Centring sleeve ZBH<sup>1)</sup>**

For piston Ø [mm]	Type	Part no.
For centring loads and attachments on the slide		
8, 10, 12, 16	ZBH-5	189652
20	ZBH-12	189653
For centring loads and attachments on the yoke plate		
8, 10	ZBH-5	189652
12, 16	ZBH-7	186717
20	ZBH-12	189653
For centring the mini slide during mounting		
8	ZBH-5	189652
10, 12	ZBH-7	186717
16	ZBH-9	150927
20	ZBH-12	189653

1) Packaging unit 10 pieces

**5 Shock absorber DYEF-Y1<sup>1)</sup> without fixed stop, standard**

For piston Ø [mm]	Type	Part no.
For DGST-...-P, elastic cushioning at both ends, self-adjusting, with end-position adjustment		
6	DYEF-G8-M4-Y1	★ 8073902
8	DYEF-G8-M5-Y1	★ 8073903
10	DYEF-G8-M6-Y1	★ 8073904
12	DYEF-G8-M8-Y1	★ 8073905
16	DYEF-G8-M10-Y1	★ 8073906
20	DYEF-G8-M12-Y1	★ 8073907
25	DYEF-G8-M14-Y1	★ 8073908

1) Included in the scope of delivery of the mini slide DGST-P (2 pieces).

**6 Shock absorber DYSS<sup>2)</sup> with fixed stop**

For piston Ø [mm]	Type	Part no.
For DGST-...-Y12, shock absorbers at both ends, self-adjusting, with end-position adjustment		
6	DYSS-G8-2-4-Y1F	★ 8073911
8	DYSS-G8-3-4-Y1F	★ 8073912
10	DYSS-G8-4-4-Y1F	★ 8073913
12	DYSS-G8-5-5-Y1F	★ 8073914
16	DYSS-G8-7-5-Y1F	★ 8073915
20	DYSS-G8-8-8-Y1F	★ 8073916
25	DYSS-G8-10-10-Y1F	★ 8073917

2) Included in the scope of delivery for the mini slide DGST-Y12 (2 pieces).

Drives with guides > Drives with guide rods >

Guided drives DFM, double-acting ★

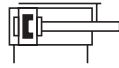
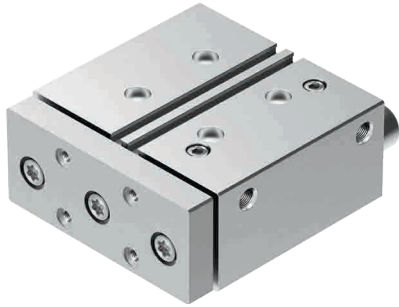

- Drive and guide unit in a single housing
  - Sturdy and precise
  - Plain or recirculating ball bearing guide
  - High resistance to torques and lateral forces
  - Wide range of applications
- Selected types in accordance with ATEX directive for potentially explosive atmospheres  
→ [www.festo.com/ex](http://www.festo.com/ex)

Order code – Basic design

001 002 003 004 005 006  
 DFM - [ ] - [ ] - P - A - [ ]

001	Type
DFM	Guided drive, double-acting
002	Piston Ø [mm]
...	6, 10, 12, 16, 20, 25, 32, 40, 50, 63
003	Stroke [mm]
...	5, 10, 15, 20, 25, 30, 40, 50, 80, 100, 125, 160, 200
004	Cushioning
P	Elastic cushioning rings/plates at both ends

Legend:  Mandatory entry

005	Position sensing
A	Via proximity switch
006	Guide
GF	Plain-bearing guide
KF	Recirculating ball bearing guide

Product options

80, 100 mm Piston Ø  
 5 ... 400 mm Variable stroke

PPV Pneumatic cushioning adjustable at both ends  
 YSRW Self-adjusting, progressive shock absorber, at both ends

S6 Heat-resistant seals up to max. 120 °C  
 AJ Precision adjustment in the end positions, advanced

EJ Precision adjustment in the end positions, retracted  
 EX3 II 2G in accordance with EU Directive 2014/34/EU



Configurable product

This product and all its product options can be ordered online via the configurator:

→ [www.festo.com/catalogue/dfm](http://www.festo.com/catalogue/dfm)

## Ordering – Basic design

003 Stroke [mm]	002 Piston Ø [mm]									
	6	10	12	16	20	25	32	40	50	63
	004 Cushioning – 005 Position sensing – 006 Plain-bearing guide									
	P – A – GF	P – A – GF	P – A – GF	P – A – GF	P – A – GF	P – A – GF	P – A – GF	P – A – GF	P – A – GF	P – A – GF
5	★ 4149944	★ 4154768								
10	★ 4149945	★ 4154769	★ 170824	★ 170832						
15	★ 4149946	★ 4154770								
20	★ 4149947	★ 4154799	★ 170825	★ 170833	★ 170840	★ 170847	★ 170854			
25			★ 170826	★ 170834	★ 170841	★ 170848	★ 170855	★ 170864	★ 170871	★ 170878
30			★ 170827	★ 170835	★ 170842	★ 170849	★ 170856			
40			★ 170828	★ 170836	★ 170843	★ 170850	★ 170857			
50			★ 170829	★ 170837	★ 170844	★ 170851	★ 170858	★ 170865	★ 170872	★ 170879
80			★ 170830	★ 170838	★ 170845	★ 170852	★ 170859	★ 170866	★ 170873	★ 170880
100			★ 170831	★ 170839	★ 170846	★ 170853	★ 170860	★ 170867	★ 170874	★ 170881
125							★ 170861	★ 170868	★ 170875	★ 170882
160							★ 170862	★ 170869	★ 170876	★ 170883
200							★ 170863	★ 170870	★ 170877	★ 170884
	004 Cushioning – 005 Position sensing – 006 Recirculating ball bearing guide									
	P – A – KF	P – A – KF	P – A – KF	P – A – KF	P – A – KF	P – A – KF	P – A – KF	P – A – KF	P – A – KF	P – A – KF
10		★ 170899	★ 170907							
20		★ 170900	★ 170908	★ 170915	★ 170922	★ 170929				
25		★ 170901	★ 170909	★ 170916	★ 170923	★ 170930	★ 170939	★ 170946	★ 170953	
30		★ 170902	★ 170910	★ 170917	★ 170924	★ 170931				
40		★ 170903	★ 170911	★ 170918	★ 170925	★ 170932				
50		★ 170904	★ 170912	★ 170919	★ 170926	★ 170933	★ 170940	★ 170947	★ 170954	
80		★ 170905	★ 170913	★ 170920	★ 170927	★ 170934	★ 170941	★ 170948	★ 170955	
100		★ 170906	★ 170914	★ 170921	★ 170928	★ 170935	★ 170942	★ 170949	★ 170956	
125							★ 170936	★ 170943	★ 170950	★ 170957
160							★ 170937	★ 170944	★ 170951	★ 170958
200							★ 170938	★ 170945	★ 170952	★ 170959

## Accessories

Piston Ø 6, 10 mm

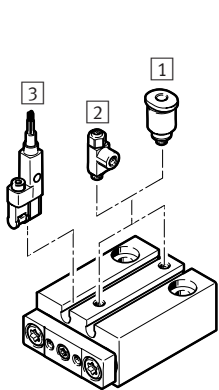

Piston Ø 12 .. 63 mm

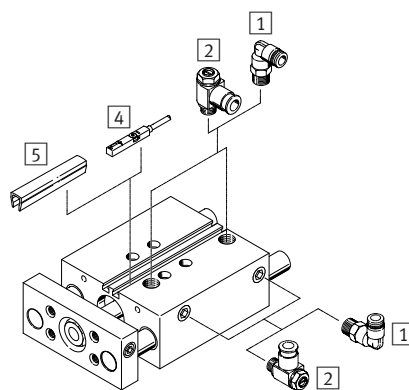

- 1 Push-in fitting QSM/QS → 166, 168
- 2 One-way flow control valve GRLA → 109
- 3 Proximity sensor SMT-10G → [dfm](#)
- 4 Proximity sensor SME-/SMT-8M → 125  
SME-/SMT-8 → [dfm](#)
- 5 Slot cover ABP-5-S → [dfm](#)

Centring sleeves ZBH for piston Ø 12 ... 63 mm (included in the scope of delivery) → [dfm](#)  
Adapter for drive/drive connections → [dfm](#)

Cylinder mounting parts and accessories for pneumatic drives >

Piston rod attachments SG, SGS, FK ★

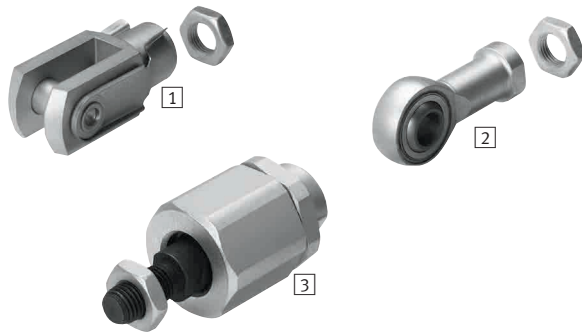

- Coordinated with Festo's cylinder range
- Versatile combinations
- Sturdy and functional
- Stainless-steel variants

- 1 Rod clevis SG: permits a swivelling movement of the cylinder in one plane
- 2 Rod eye SGS: with spherical bearing
- 3 Self-aligning rod coupler FK: for compensating radial and angular deviations

Order code

001 002  
 -

Legend:  Mandatory entry

001	Type
SG	Rod clevis
SGS	Rod eye
FK	Self-aligning rod coupler
002	Piston rod thread
M4	Male thread M4
M5	Male thread M5
M6	Male thread M6
M8	Male thread M8
M10x1,25	Male thread M10x1.25
M12x1,25	Male thread M12x1.25
M16x1,5	Male thread M16x1.5
M20x1,5	Male thread M20x1.5

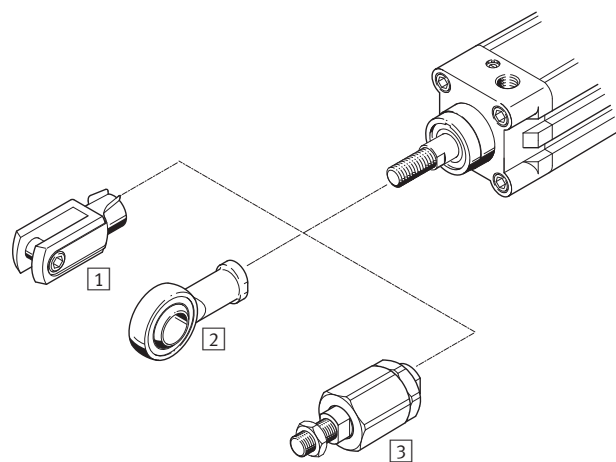

Product options

- CRSG Rod clevis in corrosion- and acid-resistant design, conforms to ISO 8140
- CRSGS Rod eye in corrosion- and acid-resistant design, conforms to ISO 12240-4 dimensional series K

- CRFK Self-aligning rod coupler in corrosion- and acid-resistant design

Cylinder mounting parts and accessories for pneumatic drives &gt;

## Piston rod attachments SG, SGS, FK ★

## Ordering

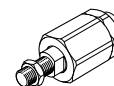
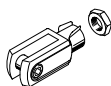

For cylinder	Piston Ø [mm]	002 Piston rod thread	001 Type		
			1 SG	2 SGS	3 FK
ADN → 26 ADVC/AEVC → 39	12	M5			30984
	16	M6	★ 3110	★ 9254	★ 2061
	20, 25	M8	★ 3111	★ 9255	★ 2062
	32, 40	M10x1.25	★ 6144	★ 9261	★ 6140
	50, 63	M12x1.25	★ 6145	★ 9262	★ 6141
	80	M16x1.5	★ 6146	★ 9263	★ 6142
DSBC → 29	32	M10x1.25	★ 6144	★ 9261	★ 6140
	40	M12x1.25	★ 6145	★ 9262	★ 6141
	50	M16x1.5	★ 6146	★ 9263	★ 6142
	63	M16x1.5	★ 6146	★ 9263	★ 6142
	80	M20x1.5	★ 6147	★ 9264	★ 6143
DSNU → 32, 34 DSNU-S → 36	8	M4	6532	9253	6528
	12, 16	M6	★ 3110	★ 9254	★ 2061
	20	M8	★ 3111	★ 9255	★ 2062
	25, 32	M10x1.25	★ 6144	★ 9261	★ 6140

# 02

# Grippers

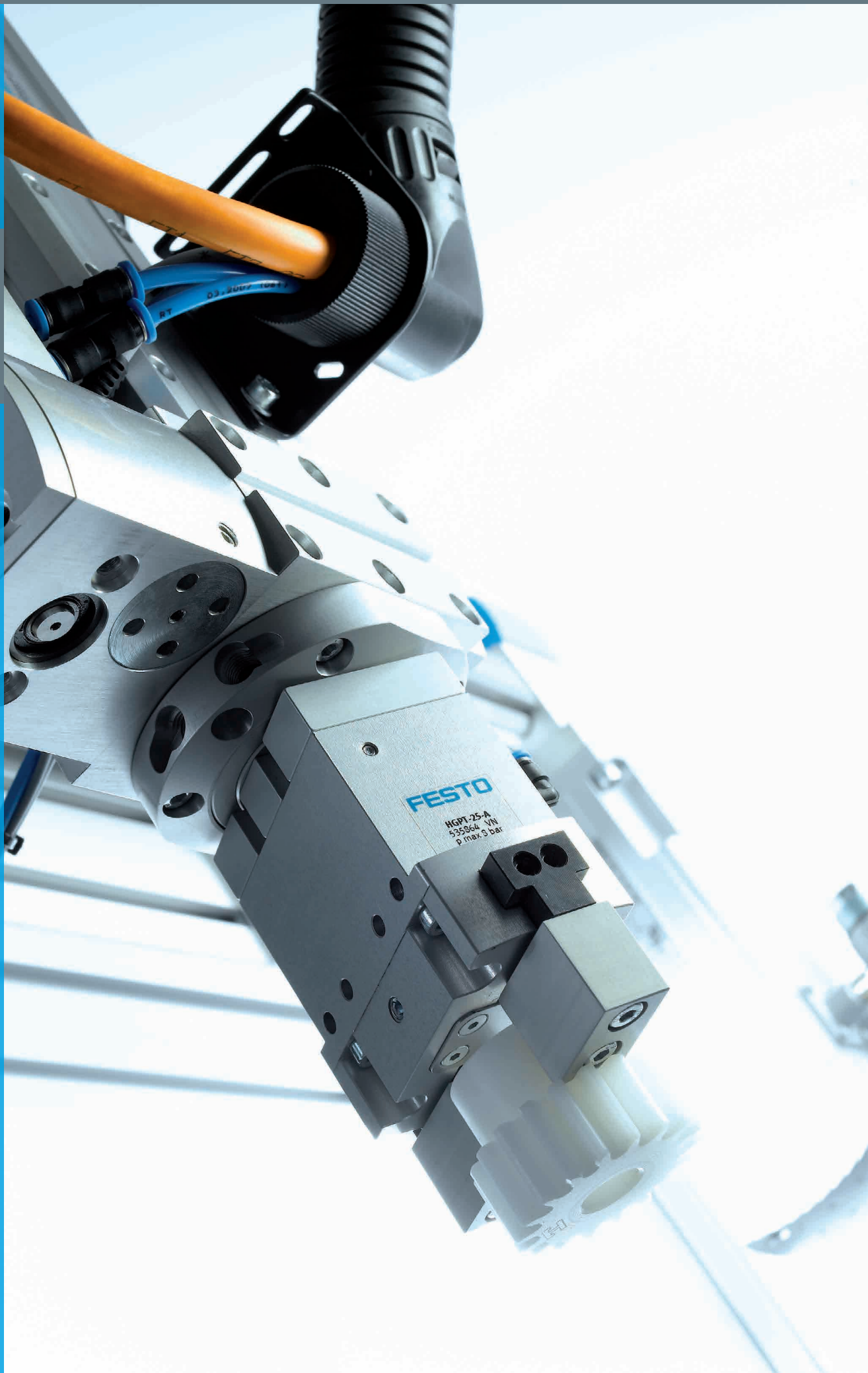

# Highlights

# Contents



Parallel grippers

## DHPS

- + Heavy-duty, precision T-slot guide for gripper jaws
- + High gripping force with compact size

→ 54

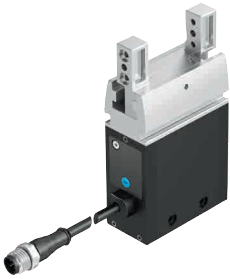

Parallel grippers, electric

## EHPS

- + Gripping force adjustable at the gripper module
- + Long stroke for different workpieces

→ 54

Product overview \_\_\_\_\_ 54

Product overview

Software-Tools

02 Grippers

**Product finder for grippers**







A secure grip is a question of the right calculation. In this case, calculation of weight, direction of movement, distances, etc.

The software tool immediately determines which type of gripper - parallel, three-point, angle or swivel/gripper - and which size best matches your requirements.



This tool can be found

- on our website at [www.festo.com/catalogue](http://www.festo.com/catalogue) by clicking on the blue button "Product Finder".

Parallel grippers

	 Parallel grippers, electric EHPS	 Parallel grippers DHPS	 Parallel grippers HGPT	 Parallel grippers HGPL-B
<b>Total gripping force at 6 bar, closing</b>	See documentation on our website	25 ... 910 N	106 ... 6300 N	158 ... 2742 N
<b>Stroke per gripper jaw</b>	10 ... 16 mm	2 ... 12.5 mm	1.5 ... 25 mm	20 ... 150 mm
<b>Position sensing</b>	Via proximity switch	Via Hall sensor, via proximity switch	Via proximity switch	Via proximity switch
<b>Gripping force backup</b>		During opening, during closing	During opening, during closing	
<b>Description</b>	<ul style="list-style-type: none"> <li>• Electric version of the pneumatically actuated parallel gripper DHPS</li> <li>• Ideal for use as a front-end actuator thanks to its low dead weight</li> <li>• Controller-free actuation using digital signals</li> <li>• Adjustable gripping force (4 settings)</li> </ul>	<ul style="list-style-type: none"> <li>• Heavy-duty, precision T-slot guide for gripper jaws</li> <li>• High gripping force with compact size</li> <li>• Max. repetition accuracy</li> <li>• Wide range of options for mounting on drives</li> </ul>	<ul style="list-style-type: none"> <li>• Sturdy and powerful</li> <li>• With T-slot guide</li> <li>• Suitable for external and internal gripping</li> <li>• Gripper jaw guide protected by sealing air against dust</li> <li>• High-force variant available</li> </ul>	<ul style="list-style-type: none"> <li>• Space-saving, high forces and torques</li> <li>• Controlled, precise and centred gripping</li> <li>• Long stroke: long guide length for the gripper jaws</li> <li>• Suitable for external and internal gripping</li> <li>• Opening stroke can be adjusted to optimise time</li> </ul>
<b>→ Page/online</b>	<a href="#">ehps</a>	<a href="#">dhps</a>	<a href="#">hgpt</a>	<a href="#">hgpl</a>

Three-point grippers

	 Three-point grippers DHDS	 Three-point grippers HGDT
<b>Total gripping force at 6 bar, closing</b>	87 ... 750 N	207 ... 2592 N
<b>Stroke per gripper jaw</b>	2.5 ... 6 mm	1.5 ... 10 mm
<b>Position sensing</b>	Via Hall sensor, via proximity switch	Via proximity switch
<b>Gripping force backup</b>	During closing	During opening, during closing
<b>Description</b>	<ul style="list-style-type: none"> <li>• Heavy-duty, precision T-slot guide for gripper jaws</li> <li>• High gripping force with compact size</li> <li>• Max. repetition accuracy</li> <li>• Wide range of options for mounting on drives</li> </ul>	<ul style="list-style-type: none"> <li>• Synchronous movement of the gripper jaws</li> <li>• With T-slot guide</li> <li>• Suitable for external and internal gripping</li> <li>• Gripper jaw guide protected by sealing air against dust</li> <li>• High-force variant available</li> </ul>
<b>→ Page/online</b>	<a href="#">dhds</a>	<a href="#">hgdt</a>



## Angle grippers

	 <p>Angle grippers DHWS</p>
<b>Total gripping torque at 6 bar, closing</b>	30 ... 1362 Ncm
<b>Max. opening angle</b>	40°
<b>Position sensing</b>	Via Hall sensor, via proximity switch
<b>Gripping force backup</b>	During closing
<b>Description</b>	<ul style="list-style-type: none"> <li>• Improved gripper jaw guide</li> <li>• Link guided movement</li> <li>• Internal fixed flow control, does away with the need for external flow control in 90% of applications</li> <li>• Max. repetition accuracy</li> <li>• Wide range of options for mounting on drives</li> </ul>
→ Page/ <a href="#">online</a>	<a href="#">dhws</a>

## Radial grippers

	 <p>Radial grippers DHRS</p>
<b>Total gripping torque at 6 bar, closing</b>	15 ... 660 Ncm
<b>Max. opening angle</b>	180°
<b>Position sensing</b>	Via Hall sensor, via proximity switch
<b>Description</b>	<ul style="list-style-type: none"> <li>• Lateral gripper jaw support for high torque loads</li> <li>• Self-centring</li> <li>• Gripper jaw centring options</li> <li>• Maximum repetition accuracy</li> </ul>
→ Page/ <a href="#">online</a>	<a href="#">dhrs</a>

Product overview

Software-Tools

02 Grippers

Feed separators

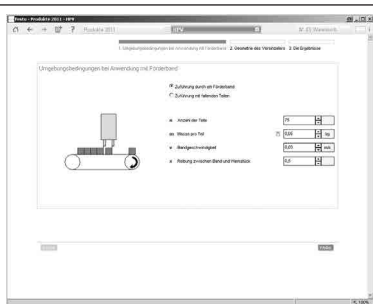

This tool helps you to select the right separator of the type HPV from Festo for your application. Let yourself be guided by the program – start by entering the general parameters and you will receive at least one suggestion for the product best suited to your application.

This tool can be found

- on our website at [www.festo.com/catalogue](http://www.festo.com/catalogue) by clicking on the blue button "Engineering".

Feed separators



Feed separators HPVS



Feed separators HPV

<b>Mode of operation</b>	Double-acting	Double-acting
<b>Piston diameter</b>	10 mm, 14 mm, 22 mm	10 mm, 14 mm, 22 mm
<b>Stroke</b>	10 ... 60 mm	10 ... 60 mm
<b>Theoretical force at 6 bar, advancing</b>	45 ... 225 N	45 ... 225 N
<b>Description</b>	<ul style="list-style-type: none"> <li>• Version with one plunger</li> <li>• With non-rotating piston rod</li> <li>• Proximity switch SME/SMT-8 can be integrated in the housing</li> </ul>	<ul style="list-style-type: none"> <li>• Version with two plungers</li> <li>• With twin piston, non-rotating piston rod and locking mechanism</li> <li>• Cost-effective: replaces at least two drives in the feed process</li> <li>• Proximity switch SME/SMT-8 can be integrated in the housing</li> </ul>
<b>→ Page/online</b>	<a href="#">hpvs</a>	<a href="#">hpv</a>



# 03

## Electromechanical drives

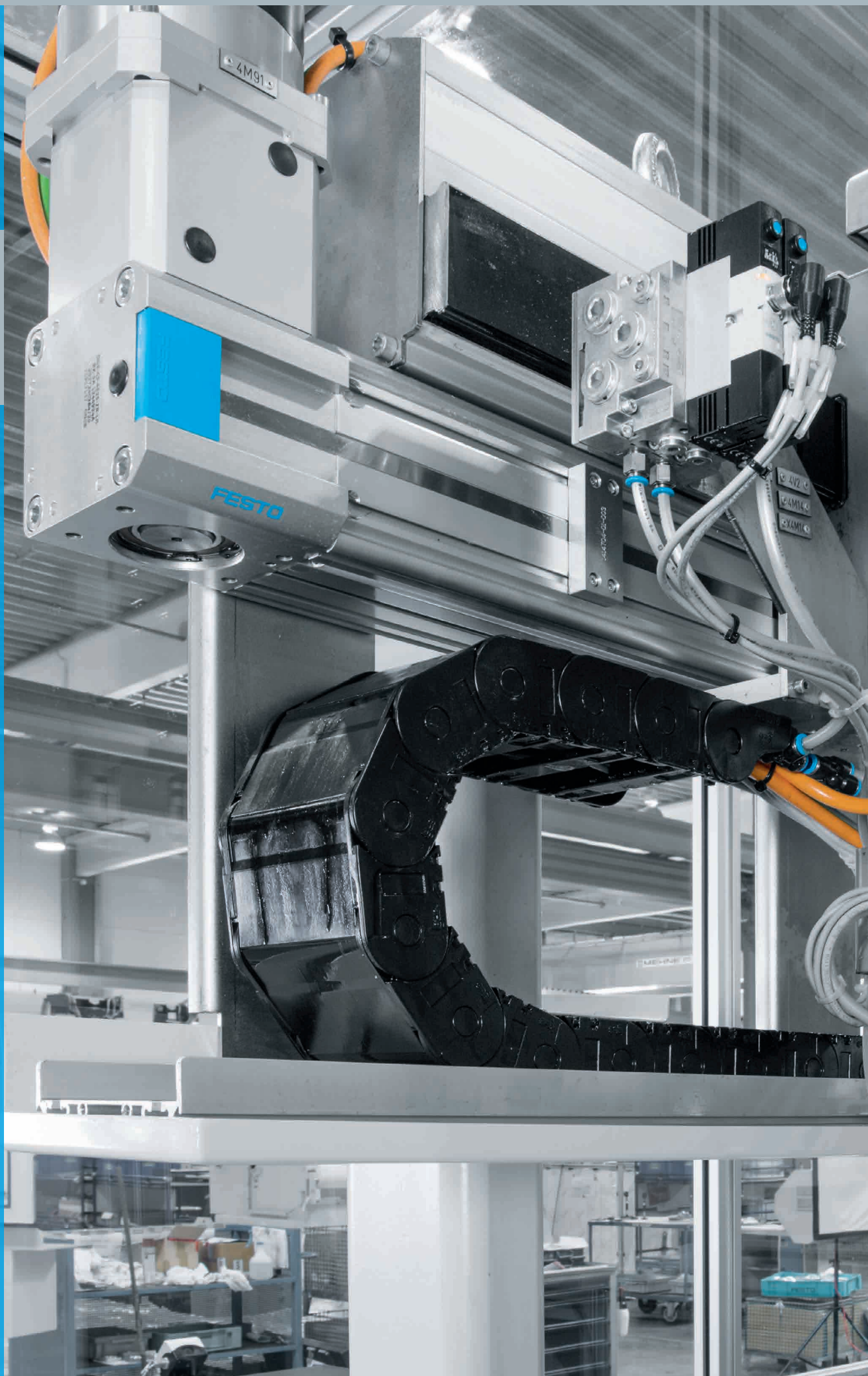

# Highlights

# Contents

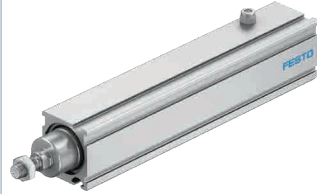

Electric cylinders with spindle drive

## EPCC

- + Low-cost: optimum price/performance ratio
- + Dynamic due to low internal friction

→ 60



Electric cylinders

## ESBF

- + High feed forces with compact size
- + Optionally with high corrosion protection

→ 60



Spindle axes

## EGC-BS-KF

- + Spindle support enables maximum travel speed
- + Optionally with clamping unit

→ 61

Product overview \_\_\_\_\_ 60

Product overview

Software-Tools

**PositioningDrives: for selecting and sizing electro-mechanical linear drives, motors and gear units**

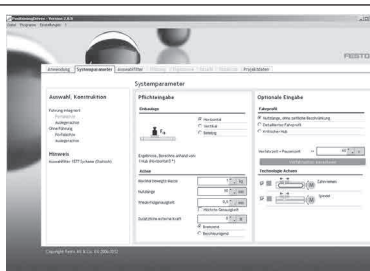

Which electromechanical linear drive, which motor and which gear unit best meets your needs? Enter the data for your application, such as position values, effective loads and mounting position, and the software will suggest several solutions.

This tool can be found

- on our website at [www.festo.com/catalogue](http://www.festo.com/catalogue) by clicking on the blue button 'Engineering'.

Linear drives and slides





Electric cylinders  
EPCC



Electric cylinders  
ESBF



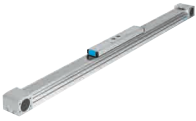

<b>Size</b>	25, 32, 45, 60	32, 40, 50, 63, 80, 100
<b>Max. feed force Fx</b>	75 ... 1000 N	1000 ... 17000 N
<b>Repetition accuracy</b>	+/-0.02 mm	+/-0.01 mm, +/-0.015 mm, +/-0.05 mm
<b>Stroke</b>	25 ... 500 mm	30 ... 1500 mm
<b>Description</b>	<ul style="list-style-type: none"> <li>• With ball screw</li> <li>• Low-cost: optimum price/performance ratio</li> <li>• Flexible: wide range of mounting options for the motor</li> <li>• Dynamic due to low internal friction</li> <li>• Short positioning times</li> <li>• Weight-optimised design ideal for handling systems</li> <li>• Unique "one-size-down" assembly system for excellent use of space</li> </ul>	<ul style="list-style-type: none"> <li>• Available with ball screw (size 32 ... 100) or lead screw (size 32 ... 50)</li> <li>• Optional: high corrosion protection, degree of protection IP65, food-safe (see <a href="http://www.festo.com/sp/esbf">www.festo.com/sp/esbf</a> &gt; "Certificates" tab), piston rod extension</li> <li>• Ball screw: three spindle pitches make it possible to select the optimal force-speed ratio</li> <li>• Axial or parallel motor mounting</li> <li>• 68 types in stock with short delivery times and modular products for custom variants</li> </ul>
<b>→ Page/online</b>	<a href="#">epc</a>	<a href="#">esbf</a>

## Linear drives and slides

	 Toothed belt axes EGC-TB-KF	 Spindle axes EGC-BS-KF	 Toothed belt axes ELGA-TB-KF	 Toothed belt axes ELGA-TB-RF
<b>Size</b>	50, 70, 80, 120, 185	70, 80, 120, 185	70, 80, 120, 150	70, 80, 120
<b>Max. feed force F<sub>x</sub></b>	50 ... 2500 N	400 ... 3000 N	260 ... 2000 N	260 ... 1000 N
<b>Repetition accuracy</b>	+/-0.08 mm, +/-0.1 mm	+/-0.02 mm	+/-0.08 mm	+/-0.08 mm
<b>Stroke</b>	50 ... 8500 mm	50 ... 3000 mm	50 ... 8500 mm	50 ... 7400 mm
<b>Description</b>	<ul style="list-style-type: none"> <li>• Recirculating ball bearing guide for high loads and torques</li> <li>• Optionally with clamping unit, at one or both ends</li> <li>• Profile with optimised rigidity</li> <li>• 22 types in stock with short delivery times and modular products for custom variants</li> </ul>	<ul style="list-style-type: none"> <li>• Recirculating ball bearing guide for high loads and torques</li> <li>• Optionally with clamping unit, at one or both ends</li> <li>• Profile with optimised rigidity</li> <li>• Various spindle pitches</li> <li>• The spindle support enables maximum travel speed</li> <li>• Axial or parallel motor mounting</li> </ul>	<ul style="list-style-type: none"> <li>• Recirculating ball bearing guide for high loads and torques</li> <li>• High feed forces</li> <li>• Precise and resilient guide rail</li> <li>• Speeds up to 5 m/s with high acceleration up to 50 m/s<sup>2</sup></li> <li>• Optional: food-safe (see <a href="http://www.festo.com/sp/elga-tb-kf">www.festo.com/sp/elga-tb-kf</a> &gt; "Certificates" tab)</li> <li>• Flexible motor connection</li> <li>• Guide and toothed belt protected by cover strip</li> <li>• 22 types in stock with short delivery times and modular products for custom variants</li> </ul>	<ul style="list-style-type: none"> <li>• Integrated roller bearing guide</li> <li>• High speeds up to 10 m/s with high acceleration up to 50 m/s<sup>2</sup></li> <li>• Guide backlash = 0 mm</li> <li>• Very good operating performance under torque load</li> <li>• Sturdy alternative to the recirculating ball bearing guide</li> <li>• As a driving component for external guides, especially for high speeds</li> <li>• Motor can be mounted on any one of four sides</li> </ul>
<b>→ Page/online</b>	<a href="#">egc-tb</a>	<a href="#">egc-bs</a>	<a href="#">elga-tb</a>	<a href="#">elga-tb</a>

Product overview

Linear drives and slides

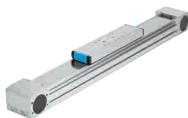
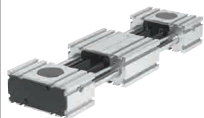

	 Mini slides EGSC-BS-KF	 Mini slide units EGSS-BS-KF	 Spindle axes ELGC-BS-KF	 Toothed belt axes ELGC-TB-KF
<b>Size</b>	25, 32, 45, 60	32, 45, 60	32, 45, 60, 80	45, 60, 80
<b>Max. feed force F<sub>x</sub></b>	70 ... 345 N	60 ... 250 N	40 ... 350 N	75 ... 250 N
<b>Repetition accuracy</b>	+/-0.015 mm	+/-0.015 mm	+/-0.01 mm, +/-0.015 mm	+/-0.1 mm
<b>Stroke</b>	25 ... 200 mm	25 ... 200 mm	100 ... 1000 mm	200 ... 2000 mm
<b>Description</b>	<ul style="list-style-type: none"> <li>Precision guide and ball screw</li> <li>Compact dimensions</li> <li>Flexible motor mounting</li> <li>The toothed belt axes, spindle axes ELGC and mini slides EGSC form a scalable modular system for compact automation</li> </ul>	<ul style="list-style-type: none"> <li>Complete solution consisting of integrated drive, motor and servo drive</li> <li>For precise vertical Z movements or individual guided linear movements</li> <li>Very high-quality ball screw with low internal friction</li> <li>Rigid, high load-bearing and precise linear guide for absorbing lateral forces and increased protection against rotation</li> <li>Integrated end-position sensing</li> <li>Two control options integrated as standard: digital I/O and IO-Link®</li> <li>Easy commissioning according to the plug and work principle: all parameters are manually adjustable directly on the drive without requiring any software or special expertise</li> <li>Product of the Simplified Motion Series: doesn't need any external servo drive or any control cabinet for the installation</li> </ul>	<ul style="list-style-type: none"> <li>Internal guide and ball screw</li> <li>Space-saving position sensing</li> <li>Flexible motor connection</li> <li>The toothed belt axes, spindle axes ELGC and mini slides EGSC form a scalable modular system for compact automation</li> </ul>	<ul style="list-style-type: none"> <li>Precise and resilient guide rail</li> <li>Internal guide and toothed belt</li> <li>Flexible motor mounting</li> <li>The toothed belt axes, spindle axes ELGC and mini slides EGSC form a scalable modular system for compact automation</li> </ul>
<b>→ Page/online</b>	<a href="#">egsc-bs</a>	<a href="#">egss</a>	<a href="#">elgc-bs</a>	<a href="#">elgc-tb</a>

Linear drives and slides

	 Spindle axes ELGA-BS-KF	 Toothed belt axes ELGA-TB-G	 Toothed belt axes ELGR
<b>Size</b>	70, 80, 120, 150	70, 80, 120	35, 45, 55
<b>Max. feed force F<sub>x</sub></b>	650 ... 6400 N	350 ... 1300 N	50 ... 350 N
<b>Repetition accuracy</b>	+/-0.02 mm	+/-0.08 mm	+/-0.1 mm
<b>Stroke</b>	50 ... 3000 mm	50 ... 8500 mm	50 ... 1500 mm
<b>Description</b>	<ul style="list-style-type: none"> <li>Internal, precision recirculating ball bearing guide with high load capacity for high torque loads</li> <li>Guide and ball screw protected by cover strip</li> <li>For the highest requirements in terms of feed force and accuracy</li> <li>Speeds up to 2 m/s with high acceleration up to 15 m/s<sup>2</sup></li> <li>Space-saving position sensing</li> <li>Flexible motor mounting</li> <li>34 preconfigured types and modular product system for custom variants</li> </ul>	<ul style="list-style-type: none"> <li>Integrated plain-bearing guide</li> <li>For small and medium loads</li> <li>Low guide backlash</li> <li>Actuator for external guides</li> <li>Speeds up to 5 m/s with high acceleration up to 50 m/s<sup>2</sup></li> <li>Flexible motor mounting</li> <li>Motor can be mounted on any one of four sides</li> </ul>	<ul style="list-style-type: none"> <li>Optimum price/performance ratio</li> <li>Ready-to-install unit for quick and easy design</li> <li>With plain or recirculating ball bearing guide</li> <li>Motor can be mounted on any one of four sides</li> <li>Also available as an Optimised Motion Series product</li> </ul>
<b>→ Page/online</b>	<a href="#">elga</a>	<a href="#">elga</a>	<a href="#">elgr</a>



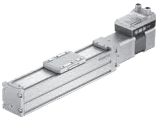

## Linear drives and slides

	 Spindle axis units ELGS-BS-KF	 Toothed belt axis units ELGS-TB-KF	 Toothed belt axis units ELGE-TB
<b>Size</b>	32, 45, 60	45, 60	35
<b>Max. feed force F<sub>x</sub></b>	40 ... 200 N	65 ... 75 N	50 N
<b>Repetition accuracy</b>	+/-0.015 mm	+/-0.1 mm	+/-0.1 mm
<b>Stroke</b>	100 ... 800 mm	50 ... 1500 mm	50 ... 800 mm
<b>Description</b>	<ul style="list-style-type: none"> <li>• Complete solution consisting of integrated drive, motor and servo drive</li> <li>• Powerful ball screw</li> <li>• Ideal for precise XY movements, e.g. in assembly plants or when handling small parts as well as for test and inspection systems</li> <li>• Protected against external influences by internal guide</li> <li>• Clean look design: easy to clean and less prone to contamination</li> <li>• Integrated end-position sensing</li> <li>• Two control options integrated as standard: digital I/O and IO-Link®</li> <li>• Easy commissioning according to the plug and work principle: all parameters are manually adjustable directly on the drive without requiring any software or special expertise</li> <li>• Product of the Simplified Motion Series: doesn't need any external servo drive or any control cabinet for the installation</li> </ul>	<ul style="list-style-type: none"> <li>• Complete solution consisting of integrated drive, motor and servo drive</li> <li>• Resilient toothed belt with long service life</li> <li>• Ideal for precise XY movements, e.g. in assembly plants or when handling small parts as well as for test and inspection systems</li> <li>• Protected against external influences by internal guide</li> <li>• Clean look design: easy to clean and less prone to contamination</li> <li>• Integrated end-position sensing</li> <li>• Two control options integrated as standard: digital I/O and IO-Link®</li> <li>• Easy commissioning according to the plug and work principle: all parameters are manually adjustable directly on the drive without requiring any software or special expertise</li> <li>• Product of the Simplified Motion Series: doesn't need any external servo drive or any control cabinet for the installation</li> </ul>	<ul style="list-style-type: none"> <li>• Complete solution consisting of integrated drive, motor and servo drive</li> <li>• Cost-optimised design for easy motion and positioning tasks between two mechanical end positions</li> <li>• Running performance of 5000 km</li> <li>• Choice of motor mounting position on four sides</li> <li>• Integrated end-position sensing</li> <li>• Two control options integrated as standard: digital I/O and IO-Link®</li> <li>• Easy commissioning according to the plug and work principle: all parameters are manually adjustable directly on the drive without requiring any software or special expertise</li> <li>• Product of the Simplified Motion Series: doesn't need any external servo drive or any control cabinet for the installation</li> </ul>
<b>→ Page/online</b>	<a href="#">elgs-bs</a>	<a href="#">elgs-tb</a>	<a href="#">elge-tb</a>

Product overview

Semi-rotary drives

	 <p><b>Rotary drive units</b> ERMS</p>	 <p><b>Rotary drives</b> ERMO</p>
<b>Size</b>	25, 32	12, 16, 25, 32
<b>Peak torque</b>	2.7... 5.6 Nm	
<b>Nominal torque</b>		0.15 ... 5 Nm
<b>Max. rotational speed</b>	100 ... 150 1/min	100 ... 150 1/min
<b>Nominal speed</b>		50 ... 200 1/min
<b>Rotation angle</b>	90°, 180°, infinite	Infinite
<b>Additional functions</b>	User interface, integrated end-position sensing	
<b>Display</b>	LED	
<b>Description</b>	<ul style="list-style-type: none"> <li>• Complete solution consisting of integrated drive, motor and servo drive</li> <li>• Cost-effective solution package for simple swivel tasks, but also for applications with high loads</li> <li>• Sealed hollow shaft for the integrated through-feed of cables and tubing</li> <li>• Standardised mounting interface for direct connection to the electric mini slides EGSL, EGSC and EGSS</li> <li>• Integrated end-position sensing</li> <li>• Two control options integrated as standard: digital I/O and IO-Link®</li> <li>• Easy commissioning according to the plug and work principle: all parameters are manually adjustable directly on the drive without requiring any software or special expertise</li> <li>• Product of the Simplified Motion Series: doesn't need any external servo drive or any control cabinet for the installation</li> </ul>	<ul style="list-style-type: none"> <li>• Electric rotary drive with stepper motor and integrated gear unit</li> <li>• ServoLite – closed-loop operation with encoder</li> <li>• Heavy-duty bearing for high forces and torques</li> <li>• Backlash-free pre-stressed rotating plate with very good axial eccentricity and concentricity properties</li> <li>• Quick and accurate installation</li> <li>• For simple rotary indexing table applications and as a rotary axis in multi-axis applications</li> <li>• Available as an Optimised Motion Series product</li> </ul>
<b>→ Page/online</b>	<a href="#">erms</a>	<a href="#">ermo</a>

Linear guides

	 <p><b>Guide units</b> EAGF</p>
<b>Size</b>	16, 25, 32, 40, 50, 63, 80, 100
<b>Stroke</b>	1 ... 550 mm
<b>Guide</b>	Recirculating ball bearing guide
<b>Description</b>	<ul style="list-style-type: none"> <li>• For electric cylinders EPCO and ESBF</li> <li>• For absorbing high process forces and torques</li> <li>• High guide precision</li> </ul>
<b>→ Page/online</b>	<a href="#">eagf</a>

## Customised components – for your specific requirements



### Drives with customised designs

Can't find the electromechanical drive you need in our catalogue?

We can offer you customised components that are tailored to your specific requirements.

Common product modifications:

- Special strokes
- Design for special ambient conditions
- Design optimised for the installation space
- Design with carriages moving in opposite directions
- Design with absolute encoder

Many additional variants are possible.

Ask your Festo sales engineer, who will be happy to help:

→ [www.festo.com/contact](http://www.festo.com/contact)

# 04

## Motors and controllers

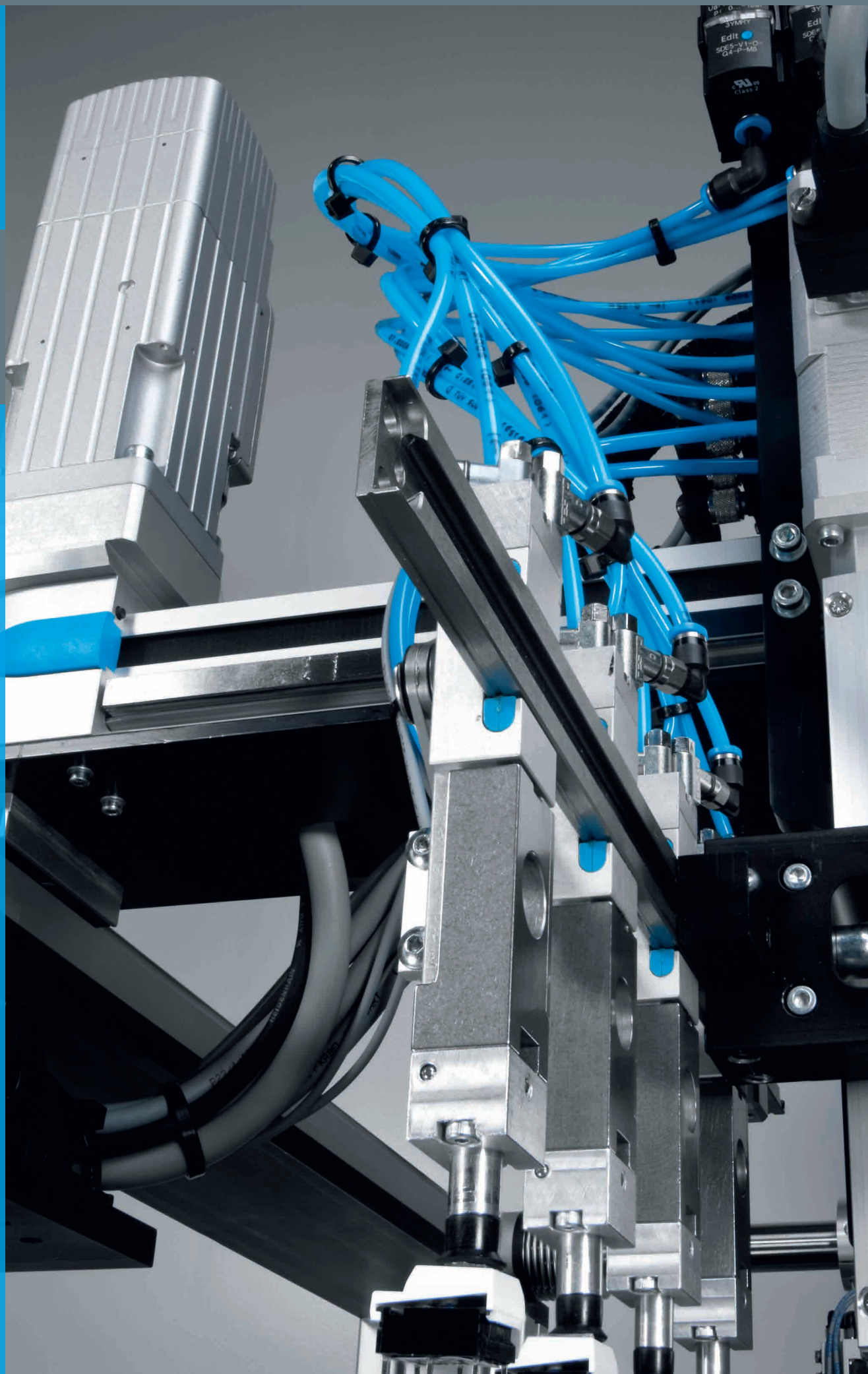

# Highlights

# Contents

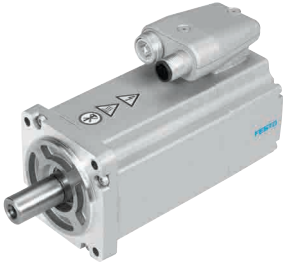

Servo motors  
**EMME-AS**  
+ Brushless, permanently excited synchronous servo motor  
+ Digital absolute displacement encoder, single-turn or multi-turn  
→ 68

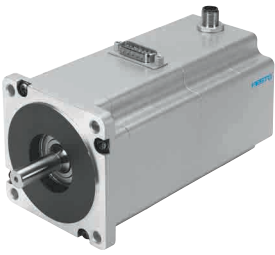

Stepper motors  
**EMMS-ST**  
+ Small increment and high driving torques thanks to 2-phase hybrid technology  
+ Optimised connection technology  
→ 69



Motor controllers  
**CMMS-ST**  
+ For actuating stepper motors EMMS-ST and drives EPCO, ELGR, ERMO  
+ Easy and convenient commissioning  
→ 71

Product overview \_\_\_\_\_ 68

Product overview

Software-Tools

04 Motors and controllers

**Festo Configuration Tool (FCT)**

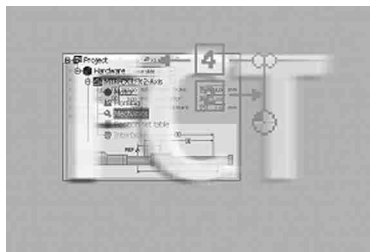

FCT is a configuration and parameterisation software program that supports all Festo devices, in particular motor controllers.

It is extremely flexible, provides full support for the device properties and is simple and intuitive to operate.

The user is guided step-by-step through the commissioning process while each individual step is checked.

The parameterisation software can be found on the website under Support > Support Portal > enter search term > select "Software" tab.

**PositioningDrives: for selecting and sizing electromechanical linear drives, motors, and gear units**

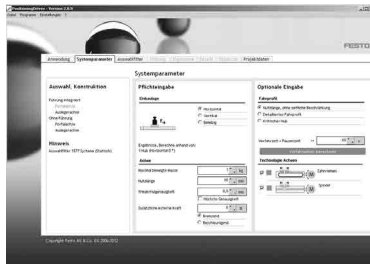

Which electromechanical linear drive, which motor and which gear unit best meets your needs?

Enter the data for your application, such as position values, effective loads and mounting position, and the software will suggest several solutions.

This tool can be found

- in the electronic catalogue by clicking on the blue button "Engineering".

Servo motors





Servo motors  
EMME-AS

<b>Nominal torque</b>	0.12 ... 6.4 Nm
<b>Nominal rotational speed</b>	3000 ... 9000 1/min
<b>Peak torque</b>	0.7 ... 30 Nm
<b>Maximum speed</b>	3910 ... 10000 1/min
<b>Description</b>	<ul style="list-style-type: none"> <li>• Brushless, permanently excited synchronous servo motor</li> <li>• Digital absolute displacement encoder, single-turn or multi-turn</li> <li>• Reliable, dynamic, precise</li> <li>• Optimised connection technology</li> <li>• Over 40 types in stock</li> <li>• Available with holding brake</li> <li>• Optional: multi-turn encoder with SIL2</li> </ul>
<b>→ Page/online</b>	<b>emme</b>

## Stepper motors

	 <p>Stepper motors EMMS-ST</p>
<b>Maximum speed</b>	430 ... 6000 1/min
<b>Motor holding torque</b>	0.09 ... 9.3 Nm
<b>Description</b>	<ul style="list-style-type: none"> <li>• Small increment and high driving torques thanks to 2-phase hybrid technology</li> <li>• Optimised connection technology</li> <li>• 28 stock types</li> <li>• With incremental encoder for closed-loop operation</li> <li>• Available with holding brake</li> </ul>
→ Page/ <a href="#">online</a>	<a href="#">emms</a>

## Gear units

	 <p>Gear units EMGA-P-EAS</p>		 <p>Gear units EMGA-P-SST</p>
<b>Continuous output torque</b>	11 ... 110 Nm		11 ... 110 Nm
<b>Max. drive speed</b>	7000 ... 18000 1/min		7000 ... 18000 1/min
<b>Torsional rigidity</b>	1 ... 6 Nm/arcmin		1 ... 6 Nm/arcmin
<b>Torsional backlash</b>	0.12 ... 0.25°		0.12 ... 0.25°
<b>Mass moment of inertia, gear unit</b>	0.019 ... 0.77 kgcm <sup>2</sup>		0.019 ... 0.77 kgcm <sup>2</sup>
<b>Max. efficiency</b>	98%		98%
<b>Description</b>	<ul style="list-style-type: none"> <li>• Planetary gear unit for servo motors EMMS-AS</li> <li>• Gear ratio i = 3 and i = 5, available from stock</li> <li>• Life-time lubrication</li> </ul>		<ul style="list-style-type: none"> <li>• Planetary gear unit for stepper motors EMMS-ST</li> <li>• Gear ratio i = 3 and i = 5, available from stock</li> <li>• Life-time lubrication</li> </ul>
→ Page/ <a href="#">online</a>	<a href="#">emga</a>		<a href="#">emga</a>

Product overview

Software-Tools

**Festo Automation Suite commissioning software**



Quickly and reliably to a ready-to-use drive system – the Festo Automation Suite combines the parameterisation, programming and maintenance of Festo components in one program and enables the entire drive package, from the mechanical system to the controller, to be commissioned. Perfect for making industrial automation simple, efficient and seamless.

**Servo drive plug-in CMMT-AS**

- An operational drive system in just 5 steps – parameterisation is almost fully automatic with the commissioning wizard
- Advanced editing with the expert view: full access to all device parameters
- Conveniently install the plug-in using the software

This tool can be found

- on our website at [www.festo.com/AutomationSuite](http://www.festo.com/AutomationSuite)

Controllers for AC servo motors



Servo drives  
CMMT-AS





Motor controllers  
CMMP-AS-M0, CMMP-AS-M3

<b>Nominal current</b>		2 ... 13 A
<b>Nominal operating voltage AC</b>	230 ... 400 V	230 ... 400 V
<b>Nominal operating voltage phases</b>	1-phase, 3-phase	1-phase, 3-phase
<b>Nominal power of controller</b>	350 ... 2500 VA	500 ... 9000 VA
<b>Fieldbus coupling</b>	EtherCAT, PROFINET	CANopen, DeviceNet, EtherCAT, EtherNet/IP, Modbus/TCP, PROFINET, PROFIBUS DP
<b>Description</b>	<ul style="list-style-type: none"> <li>• Can be used universally</li> <li>• The latest generation of servo drive systems with optimised prices and sizes</li> <li>• One of the most compact servo drives on the market</li> <li>• Configure standard safety functions without software</li> <li>• Auto-tuning supports easy commissioning and automatically optimises the control behaviour of rotary and linear motions</li> <li>• Precise force, speed and position control</li> <li>• Optimised for use with servo motor EMMT-AS</li> </ul>	<ul style="list-style-type: none"> <li>• Many interfaces and functions for decentralised motion functions (flying saw, flying measurement, modulo function, etc.)</li> <li>• Optional: integrated cam disk controllers and highly dynamic movements</li> <li>• Standardised interfaces allow seamless integration in mechatronic multi-axis modular systems</li> <li>• Reliable and convenient commissioning and parameterisation with the Festo Configuration Tool (FCT)</li> <li>• Optionally with 3 slots, safety module or extension module</li> <li>• 255 position sets</li> </ul>
<b>→ Page/online</b>	<a href="#">cmmt</a>	<a href="#">cmmmp</a>



## Controllers for stepper motors

	 Servo drives CMMT-ST	 Motor controllers CMMO-ST	 Motor controllers CMMS-ST
<b>Nominal current, load supply</b>		6 A	8 A
<b>Nominal voltage, load supply DC</b>	24 V, 48 V	24 V	48 V
<b>Fieldbus coupling</b>		EtherNet	CANopen, PROFIBUS DP
<b>Description</b>	<ul style="list-style-type: none"> <li>• Very efficient for tasks with low power requirements</li> <li>• Ideal for positioning tasks and point-to-point and interpolating motion solutions</li> <li>• 50% more compact than the smallest servo drive CMMT-AS</li> <li>• Optimised for use with stepper motors like the proven EMMS-ST</li> </ul>	<ul style="list-style-type: none"> <li>• Motor controllers from the Optimised Motion Series (for electric cylinders EPCO, toothed belt axes ELGR, rotary drives ERMO)</li> <li>• With convenient FCT (Festo Configuration Tool) commissioning for stepper motors EMMS-ST</li> <li>• Quick and easy parameterisation via web browser and parameter cloud</li> <li>• Reliable and convenient commissioning and parameterisation with the Festo Configuration Tool (FCT)</li> <li>• Simple control via digital I/O, IO-Link®, I-Port, Modbus TCP</li> <li>• Safety function safe torque off (STO) PLd</li> <li>• Sinusoidal current injection for especially silent motor operation</li> <li>• Compact design</li> </ul>	<ul style="list-style-type: none"> <li>• For controlling stepper motors EMMS-ST and Optimised Motion Series (for electric cylinders EPCO, toothed belt axes ELGR, rotary drives ERMO)</li> <li>• Easy and convenient: commissioning and firmware updates via SD card slot</li> <li>• Reliable and convenient commissioning and parameterisation with the Festo Configuration Tool (FCT)</li> <li>• Integrated process interface: digital I/O, CAN, RS485</li> <li>• Safety function Safe Torque Off (STO) PLd</li> <li>• Optional: PROFIBUS and DeviceNet®</li> </ul>
<b>→ Page/online</b>	<a href="#">cmmt-st</a>	<a href="#">cmmo-st</a>	<a href="#">cmms-st</a>

## Positioners for process automation

	 Positioners CMSX
<b>Standard nominal flow rate</b>	50 ... 130 l/min
<b>Ambient temperature</b>	-5 ... 60°C
<b>Setpoint value</b>	0 - 20 mA, 4 - 20 mA, 0 - 10 V
<b>Operating voltage range DC</b>	21.6 ... 26.4 V
<b>Operating pressure</b>	3 ... 8 bar
<b>Safety information</b>	Safety position: in the case of a broken cable or operating voltage failure, the regulating action is to hold. Safety position: in the case of a broken cable or an operating voltage failure, the regulating action is opening/closing.
<b>Degree of protection</b>	IP65
<b>Type of mounting</b>	Via accessories, on flange ISO 5211
<b>Information on housing materials</b>	PC
<b>Description</b>	<ul style="list-style-type: none"> <li>• Digital electropneumatic positioner for single-acting or double-acting pneumatic quarter turn actuators and double-acting pneumatic linear actuators</li> <li>• No air consumption in the regulated state</li> </ul>
<b>→ Page/online</b>	<a href="#">207</a>

# 05

## Handling systems

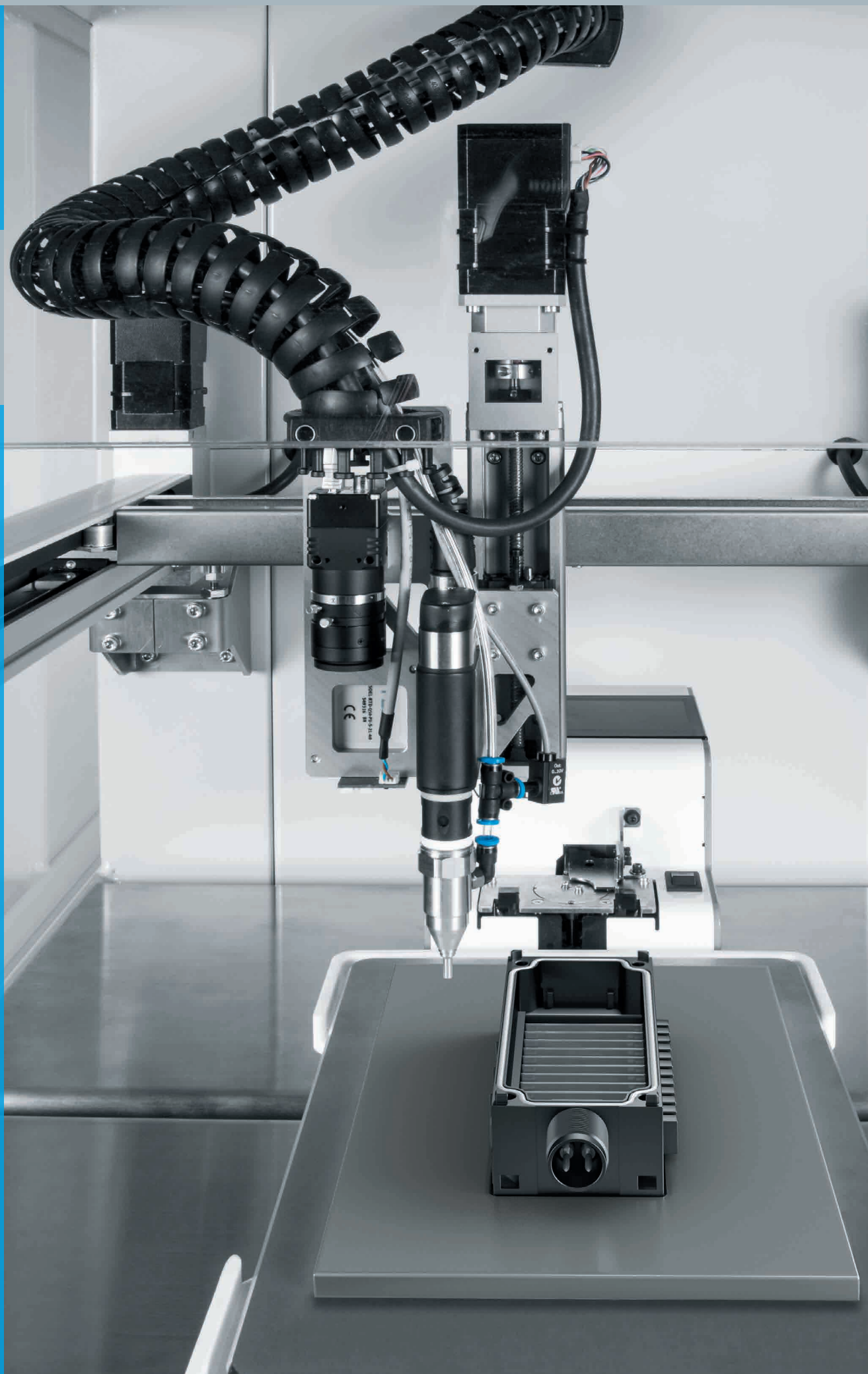

# Highlights

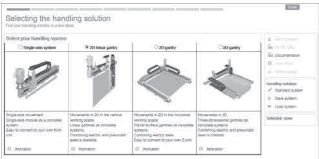

Handling Guide Online  
**HGO**

- + Configuration and ordering system for standard handling systems of the YXC... series
- + Economical and reliable

→ 74



Planar surface gantries  
**EXCM**

Compact gantry

- + Perfectly matched drive and controller packages

→ 75



Planar surface gantries  
**EXCH**

- + Maximum working space coverage
- + Low moving mass
- + High payload

→ 75

# Contents

Product overview \_\_\_\_\_ 74

Product overview

Software-Tools

**Engineering tool:  
Handling Guide Online (HGO)**

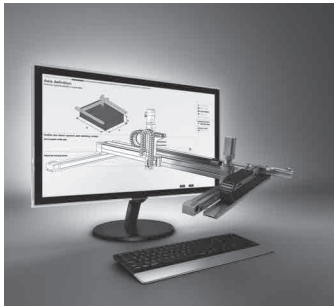

Planning and designing complex handling systems, e.g. for pick & place applications, generally takes a lot of time.

With the innovative Handling Guide Online (HGO) you can design a tailor-made system in just a few steps. Simply enter your application data such as the load mass, travel and cycle time.

Advantages:

- 1D- ... 3D kinematics
- Tailor-made system solution within just a few minutes
- CAD model available immediately
- Fully automatic selection of all relevant components
- Fully automated processing including ordering function
- Fully assembled or unassembled systems

This tool is integrated in the Festo online catalogue or can be called up directly at

→ [www.festo.com/handling-guide](http://www.festo.com/handling-guide)

Cartesian systems



Planar surface gantries, compact  
YXMF





Planar surface gantries, highly dynamic  
YXMF



2D planar surface gantries  
YXCF

	Planar surface gantries, compact YXMF	Planar surface gantries, highly dynamic YXMF	2D planar surface gantries YXCF
<b>Description</b>	<ul style="list-style-type: none"> <li>• Parallel kinematic drive concept with minimal space requirements</li> <li>• Ready-to-install complete system including energy chain, matching motors and dual motor controller</li> <li>• For two-dimensional movements in horizontal working spaces</li> <li>• Flexible working space due to scalable strokes in the X and Y directions</li> <li>• Based on the planar surface gantry EXCM</li> <li>• For extremely small working spaces</li> <li>• For desktop applications in small parts assembly, electronics manufacturing and laboratory processes</li> </ul>	<ul style="list-style-type: none"> <li>• Parallel kinematic drive concept for maximum dynamic response</li> <li>• Ready-to-install complete system including energy chain and matching motor and motor controller package</li> <li>• For two-dimensional movements in horizontal working spaces</li> <li>• Flexible working space due to scalable strokes in the X and Y directions</li> <li>• Based on the planar surface gantry EXCH</li> <li>• Maximum dynamic response and efficient operation up to max. 100 picks/min</li> <li>• For rapid processes with high cycle rates like pick &amp; place, feeding parts, stacking, packaging tasks</li> <li>• Cost-saving alternative to two Scara robots due to large working space and high dynamic response</li> </ul>	<ul style="list-style-type: none"> <li>• Ready-to-install complete system including energy chain for cables or tubing as well as matching motor and motor controller package</li> <li>• For two-dimensional movements in horizontal working spaces</li> <li>• Flexible working space due to scalable strokes in the X and Y directions</li> <li>• X-axis based on toothed belt axis EGC-TB</li> <li>• Y-axis based on the toothed belt axis EGC-TB and toothed belt axis with heavy-duty guide EGC-HD-TB</li> <li>• Especially suitable for very long strokes</li> </ul>
→ Page/online	<a href="#">yxmf</a>	<a href="#">yxmf</a>	<a href="#">yxcf</a>

## Cartesian systems

	 <p>2D planar surface gantries EXCM</p>	 <p>2D planar surface gantries EXCH</p>
<p><b>Description</b></p>	<ul style="list-style-type: none"> <li>• Excellent functionality in confined spaces</li> <li>• Low moving dead weight</li> <li>• Actuation via two stepper motors with integrated optical encoder and two-axis controller</li> <li>• With recirculating ball bearing guide</li> </ul>	<ul style="list-style-type: none"> <li>• Optimal dynamic response when compared with other Cartesian gantry systems</li> <li>• Drive concept with low moving dead weight</li> <li>• Flat system design</li> <li>• High acceleration in both axial directions</li> <li>• Large working space</li> </ul>
<p>→ <a href="#">Page/online</a></p>	<p><a href="#">excm</a></p>	<p><a href="#">exch</a></p>

# 06

## Vacuum technology

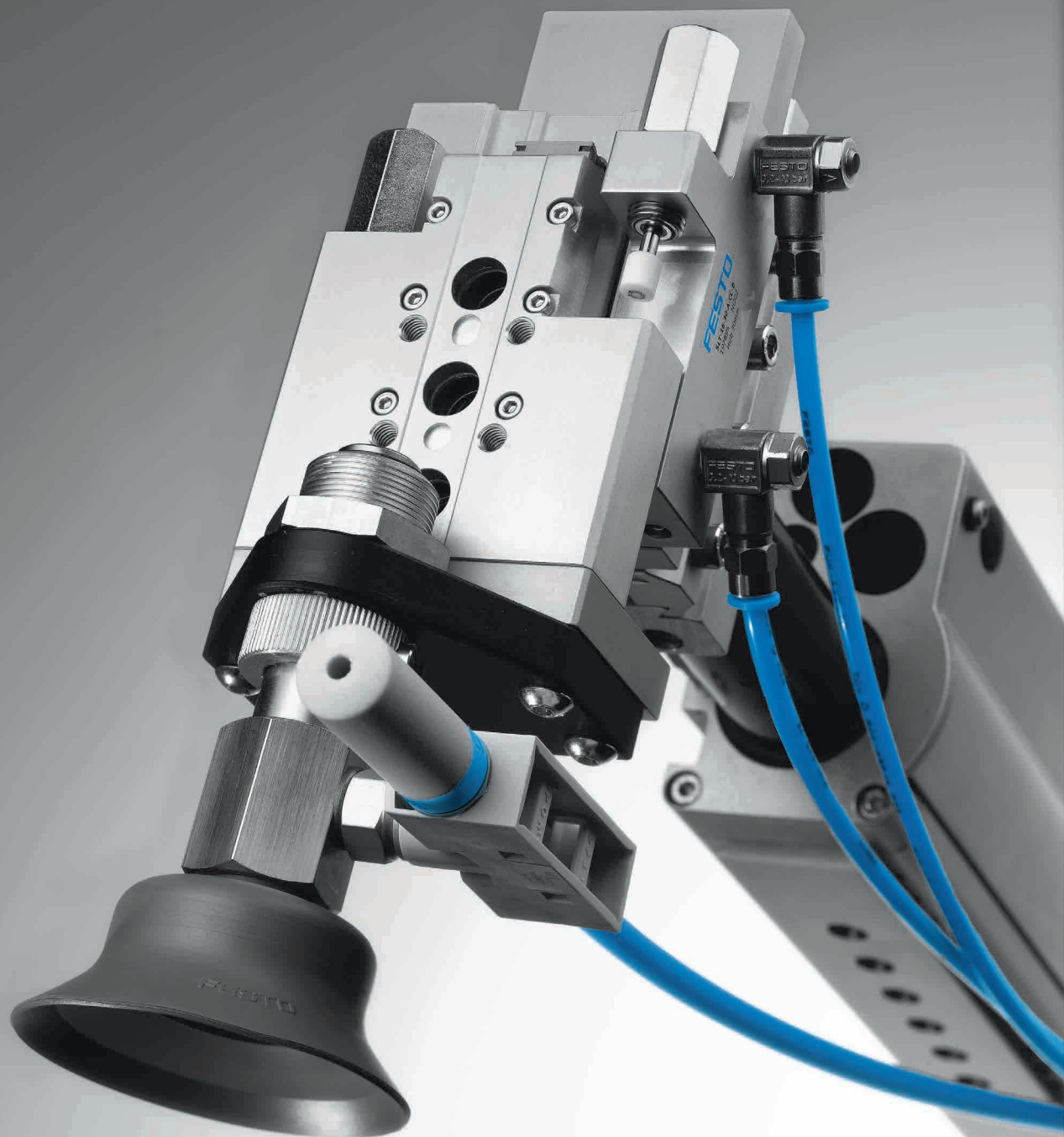

# Highlights

# Contents

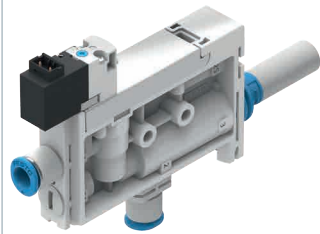

Vacuum generators

## OVEL

- + Ideal for fast small parts handling
- + Lightweight design for installing in the gripping area

→ 78

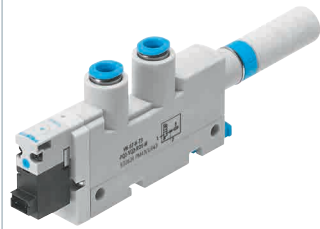

Vacuum generators

## VN

- + Generate a vacuum easily and quickly
- + Lightweight design for installing in the gripping area

→ 78

Product overview ..... 78

Product overview

Software-Tools



**Vacuum selection**



Which suction cup for which surface and which movement?  
Don't experiment – calculate!  
.This software tool even enables a distinction to be made between linear and rotary movements.



This tool can be found  
• on our website at [www.festo.com/catalogue](http://www.festo.com/catalogue) by clicking on the blue button "Engineering".

Vacuum generators

	 Vacuum generators OVEL	 Vacuum generators OVEM	 Vacuum generators, pneumatic VN
<b>Nominal width of Laval nozzle</b>	0.45 ... 0.95 mm	0.45 ... 3 mm	0.45 ... 3 mm
<b>Ejector characteristic</b>	High suction rate, high vacuum, standard	High suction rate, high vacuum, standard	High suction rate, high vacuum, standard, inline, high vacuum, high suction rate
<b>Integrated function</b>	Electrical ejector pulse, flow control valve, pressure sensor, pressure transmitter, electric on/off valve, filter, open silencer	Electric ejector pulse valve, flow control valve, electric on/off valve, filter, electric air saving function, check valve, open silencer, vacuum switch	Pneumatic ejector pulse valve, open silencer, vacuum switch
<b>Max. vacuum</b>	89 ... 92%	93%	86 ... 93%
<b>Max. suction rate with respect to atmosphere</b>	4 ... 21 l/min	6 ... 348 l/min	6.1 ... 339 l/min
<b>Description</b>	<ul style="list-style-type: none"> <li>• Low-cost, compact vacuum generator</li> <li>• Low weight</li> <li>• Various performance levels and vacuum types</li> <li>• Short switching times thanks to integrated solenoid valves</li> <li>• Fast, precise and safe setting down of the workpiece via ejector pulse</li> <li>• Simple installation via H3 plugs and push-in fittings</li> </ul>	<ul style="list-style-type: none"> <li>• Compact design</li> <li>• Monitoring with vacuum sensor with IO-Link®</li> <li>• Central electrical connection via an M12 plug</li> <li>• Maintenance-free operation and reduced noise level through an integrated, open silencer</li> <li>• Integrated filter with inspection window</li> <li>• Optionally with air-saving function and LCD display</li> <li>• Adjustable ejector pulse</li> </ul>	<ul style="list-style-type: none"> <li>• Can be used directly in the work space</li> <li>• Available as straight type (in-line: vacuum port in line with the supply port) or T-shape (standard: vacuum port at 90° to the supply port)</li> <li>• Compact and cost-effective</li> <li>• Maintenance-free operation and reduced noise level through an integrated, open silencer</li> </ul>
<b>→ Page/online</b>	<a href="#">ovel</a>	<a href="#">ovem</a>	<a href="#">vn</a>



## Vacuum gripping technology

	 Suction cups with connector ESS	 Suction cups without connector ESV	 Suction cups with connector VAS, VASB
<b>Suction cup size</b>	4x20 mm, 6x10 mm, 6x20 mm, 8x20 mm, 8x30 mm, 4x10 mm, 10x30 mm, 15x45 mm, 20x60 mm, 25x75 mm, 30x90 mm		
<b>Gripper diameter</b>			
<b>Suction cup diameter</b>	2 ... 200 mm	20 ... 200 mm	2 ... 125 mm
<b>Holding force at nominal operating pressure</b>	0.1 ... 1610 N	8.2 ... 1610 N	0.14 ... 700 N
<b>Design</b>	Round, bell-shaped	Bell-shaped or round bellows	
<b>Information on suction cup materials</b>	BR, FPM, NBR, PUR, VMQ (silicone), Vulkollan®	BR, FPM, NBR, PUR, VMQ (silicone), Vulkollan®	NBR, PUR, TPE-U (PU), VMQ (silicone)
<b>Description</b>	<ul style="list-style-type: none"> <li>• Suction cup consisting of the suction cup itself, plus the support plate with mounting</li> <li>• Suction cup volume: 0.002 ... 245 cm<sup>3</sup></li> <li>• Min. workpiece radius: 10 ... 680 mm</li> <li>• Mounting for suction cup holder: female thread, male thread, push-in connector</li> <li>• Suction cup with mounting thread</li> </ul>	<ul style="list-style-type: none"> <li>• Wearing part for suction cup ESS</li> <li>• Easily interchangeable</li> <li>• Suction cup volume: 0.318 ... 245 cm<sup>3</sup></li> <li>• Min. workpiece radius: 10 ... 680 mm</li> </ul>	<ul style="list-style-type: none"> <li>• Sturdy and reliable</li> <li>• Suction cup with fixed connecting thread</li> <li>• 11 suction cup diameters</li> <li>• Round suction cup shape, bellows</li> <li>• Vacuum port on top, on the side</li> <li>• Screw-in thread</li> </ul>
<b>→ Page/online</b>	<a href="#">ess</a>	<a href="#">esv</a>	<a href="#">vas</a>

# 07

# Valves

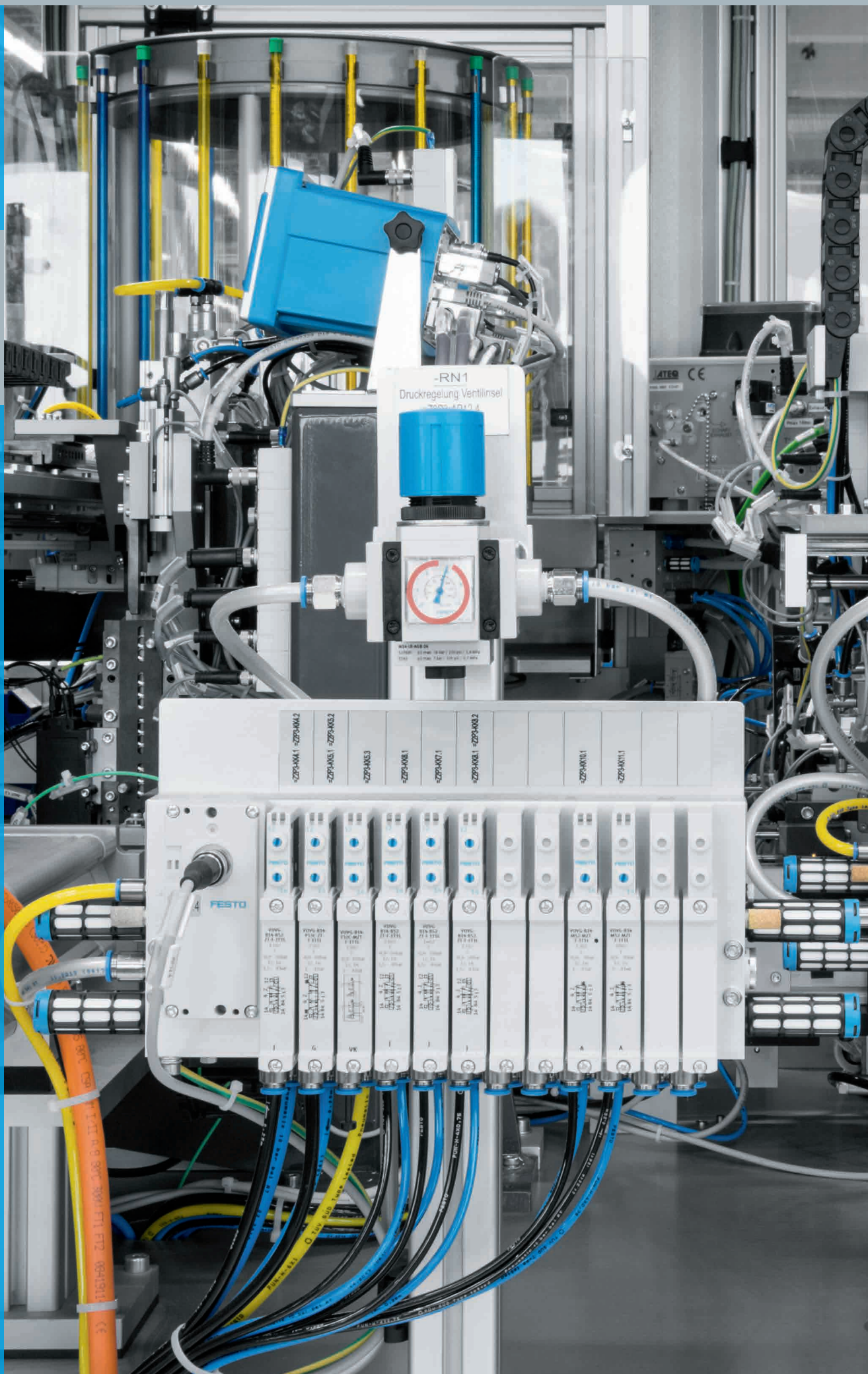

# Highlights



Universal directional control valves

## VUVS

- + Piston spool with sealing cartridge (VUVS-L) or sealing ring (VUVS-LK)
- + Can be used as an individual valve or manifold valve VTUS

→ 93



Universal directional control valves

## VUVG

- + Universal valve, sturdy and durable
- + Can be used as an individual valve or manifold valve VTUG





→ 97

# Contents





Product overview	82
Solenoid valves VUVS ★	93
Solenoid valves VUVG ★	97
Solenoid valves VSNC, to NAMUR ★	102
Solenoid valve VSVA, to ISO 5599-1 ★	104
Solenoid valve VSVA, to ISO 15407-1 ★	106
Check valves, piloted HGL ★	108
One-way flow control valves GRLA, GRLZ ★	109

Product overview

Universal directional control valves



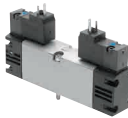

				
	<b>Solenoid valves VUVS</b>	<b>Solenoid valves, for individual connection VUVG</b>	<b>Solenoid valves, plug-in VUVG</b>	<b>Solenoid and pneumatic valves, Tiger Classic MFH, MOFH, JMFH, JMGDH, VL/O, VL, JH, JDH</b>
<b>Actuation type</b>	Electrical	Electrical	Electrical	Electrical, pneumatic
<b>Pneumatic connection 1</b>	1/8 NPT, G1/4, G1/8, G3/8	G1/4, G1/8, M3, M5, M7		G1/2, G1/4, G1/8, G3/4
<b>Pneumatic working port</b>	1/8 NPT, 1/4 NPT, 3/8 NPT, G1/4, G1/8, G3/8, QS-1/2, QS-1/4, QS-10, QS-12, QS-3/8, QS-4, QS-5/16, QS-5/32, QS-6, QS-8	Flange, G1/4, G1/8, M3, M5, M7, QS-1/4, QS-1/8, QS-10, QS-3, QS-3/16, QS-3/8, QS-4, QS-5/16, QS-5/32, QS-6, QS-8	Flange, G1/4, G1/8, M5, M7	G1/2, G1/4, G1/8, G3/4
<b>Standard nominal flow rate</b>	500 ... 2400 l/min	80 ... 1380 l/min	130 ... 1200 l/min	500 ... 7500 l/min
<b>Valve function</b>	2x3/2-way, single solenoid, closed, 2x3/2-way, single solenoid, open, 2x3/2-way, single solenoid, open/closed, 3/2-way, single solenoid, closed, 3/2-way, single solenoid, open, 5/2-way, double solenoid, 5/2-way, single solenoid, 5/3-way, pressurised, 5/3-way, exhausted, 5/3-way, closed	2x3/2-way, single solenoid, closed, 2x3/2-way, single solenoid, open, 2x3/2-way, single solenoid, open/closed, 5/2-way, double solenoid, 5/2-way, single solenoid, 5/3-way, pressurised, 5/3-way, exhausted, 5/3-way, closed	2x3/2-way, single solenoid, closed, 2x3/2-way, single solenoid, open, 2x3/2-way, single solenoid, open/closed, 3/2-way, single solenoid, closed, 3/2-way, single solenoid, open, 5/2-way, double solenoid, 5/2-way, single solenoid, 5/3-way, pressurised, 5/3-way, exhausted, 5/3-way, closed	3/2-way, solenoid/monostable, closed, 3/2-way, single solenoid/monostable, open, 3/2-way, single solenoid/monostable, open/closed, 5/2-way, double solenoid/bistable, 5/2-way, double solenoid/bistable, dominant signal, 5/2-way, single solenoid/monostable
<b>Electrical connection</b>	To EN 175301-803, type B, type C	Plug, via E-box, connection pattern H, horizontal connection, M8x1 A-coded to EN 61076-2-104, 2-pin, 3-pin	Via sub-base	Via F coil, to be ordered separately
<b>Description</b>	<ul style="list-style-type: none"> <li>• Universal valve, sturdy and durable</li> <li>• Low-cost, no limitations with regard to performance</li> <li>• Can be used as individual valves or manifold valves VTUS</li> </ul>	<ul style="list-style-type: none"> <li>• Compact universal valve</li> <li>• Connection technology via electrical connection box (E-box)</li> <li>• High flow rate relative to its size</li> <li>• In-line valves can be used as individual valves or manifold valves</li> </ul>	<ul style="list-style-type: none"> <li>• Sub-base valve</li> <li>• For valve terminal VTUG with multi-pin plug, fieldbus interface</li> <li>• Variants to EU Explosion Protection Directive (ATEX)</li> </ul>	<ul style="list-style-type: none"> <li>• Sturdy and reliable</li> <li>• Poppet valve</li> <li>• All-metal version</li> <li>• Principle with armature tube</li> </ul>
<b>→ Page/online</b>	<b>93</b>	<b>97</b>	<b>97</b>	<b>tiger classic</b>

## Standards-based directional control valves





	 <b>Solenoid valves VSNC</b>	 <b>Standards-based valves with central plug VSVA-R5, VSVA-R2</b>	 <b>Standards-based valves with indi- vidual plug VSVA-C1, VSVA-P1</b>	 <b>Standards-based valves, plug-in VSVA-T1</b>
<b>Actuation type</b>	Electrical	Electrical	Electrical	Electrical
<b>Pneumatic connection 1</b>	1/4 NPT, G1/4, QS-1/4, QS-10, QS-3/8, QS-5/16, QS-6, QS-8	Sub-base size 1 to ISO 5599-1, size 2 to ISO 5599-1	Sub-base size 18 to ISO 15407-1, size 26 to ISO 15407-1	Sub-base size 1 to ISO 5599-2, size 2 to ISO 5599-2, size 18 to ISO 15407-2, size 26 to ISO 15407-2
<b>Standard nominal flow rate</b>	800 ... 1350 l/min	400 ... 2800 l/min	400 ... 1400 l/min	370 ... 2900 l/min
<b>Valve function</b>	5/2-way, double solenoid, 5/2 or 3/2-way, convertible, 5/3-way, pressurised, 5/3-way, exhausted, 5/3-way, closed	2x2/2-way, single solenoid, closed, 2x3/2-way, single solenoid, closed, 2x3/2-way, single solenoid, open, 2x3/2-way, single solenoid, open/closed, 5/2-way, double solenoid, 5/2-way, double solenoid, dominant signal, 5/2-way, single solenoid, 5/3-way, pressurised, 5/3-way, exhausted, 5/3-way, closed	2x2/2-way, single solenoid, closed, 2x3/2-way, single solenoid, closed, 2x3/2-way, single solenoid, open, 2x3/2-way, single solenoid, open/closed, 5/2-way, double solenoid, 5/2-way, double solenoid, dominant signal, 5/2-way, single solenoid, 5/3-way, pressurised, 5/3-way, exhausted, 5/3-way, closed	2x2/2-way, single solenoid, closed, 2x3/2-way, single solenoid, closed, 2x3/2-way, single solenoid, open, 2x3/2-way, single solenoid, open/closed, 5/2-way, double solenoid, 5/2-way, double solenoid, dominant signal, 5/2-way, single solenoid, 5/3-way, pressurised 1 to 2, 4 to 5 closed, 5/3-way, pressurised, 5/3-way, exhausted, 5/3-way, closed, 5/3-way, port 2 pressurised, 4 exhausted, 5/3-way, port 4 pressurised, 2 exhausted
<b>Electrical connection</b>	Plug, to EN 175301-803, to industry standard (11 mm), type A, type B, 3-pin	Central plug, round design, 3-pin, 4-pin, M8x1, M12x1	To EN 175301-803, to DIN EN 175301-803, type C, with protective earth conductor, without protective earth conductor	Plug, plug-in, to ISO 15407-2, to ISO 5599-2, 2-pin, 4-pin
<b>Description</b>	<ul style="list-style-type: none"> <li>• Connection pattern to NAMUR to VDI/VDE 3845</li> <li>• Replaceable seal for 3/2-way or 5/2-way valve</li> <li>• Wide choice of EX solenoid systems</li> <li>• Sturdy and powerful</li> <li>• Extended temperature range</li> <li>• Outstanding value for money</li> <li>• All solenoid coils can be used on an armature tube</li> <li>• The variant VSNC-...FN achieves increased energy efficiency thanks to reduced power consumption</li> </ul>	<ul style="list-style-type: none"> <li>• Conforms to ISO 5599-1</li> <li>• Electrical connection via central plug</li> <li>• Sturdy metal housing</li> <li>• Manifold assembly with mixture of sizes possible</li> </ul>	<ul style="list-style-type: none"> <li>• Conforms to ISO 15407-1 and to ISO 15218 for pilot valve with interface</li> <li>• Electrical connection via type C plug</li> <li>• Sturdy metal housing</li> <li>• Manifold assembly with mixture of sizes possible</li> </ul>	<ul style="list-style-type: none"> <li>• For valve terminal VTSA/VTSA-F</li> <li>• Sturdy metal housing</li> </ul>
<b>→ Page/online</b>	<b>102</b>	<b>104</b>	<b>106</b>	<b>vsva</b>

Product overview



Application-specific directional control valves

	 Solenoid valves VOFD	 Solenoid valves VOFC	 Solenoid valves MHE2, MHP2, MHA2, MHE3, MHP3, MHA3, MHE4, MHP4, MHA4	 Fast-switching valves MHJ9, MHJ10
<b>Design</b>	Directly actuated poppet valve	Piston spool, piloted poppet valve	Pressure-relieved poppet valve	Poppet valve without spring return
<b>Valve function</b>	3/2-way, single solenoid, closed, semi-automatic, 3/2-way, single solenoid, closed	3/2-way, single solenoid, closed, 5/2-way, double solenoid, 5/2-way, single solenoid	3/2-way, single solenoid, closed, 3/2-way, single solenoid, open, 5/2-way, single solenoid	2/2-way, single solenoid, closed
<b>Operating pressure</b>	0 ... 12 bar	0 ... 10 bar	-0.9 ... 8 bar	0.5 ... 8 bar
<b>Ambient temperature</b>	-50 ... 60°C	-25 ... 60°C	-5 ... 60°C	-5 ... 60°C
<b>Pneumatic connection 1</b>	Connection pattern to NAMUR, 1/4 NPT, G1/4, M5	Connection pattern to NAMUR, G1/2, G1/4, M5, NPT1/4-18	Sub-base, G1/4, G1/8, M7, QS-4, QS-6, QS-8	Sub-base, QS-4, QS-6
<b>Standard nominal flow rate</b>	52 ... 1900 l/min	766 ... 2686 l/min	90 ... 400 l/min	50 ... 160 l/min
<b>Description</b>	<ul style="list-style-type: none"> <li>• Suitable for process automation, for applications in chemical and petrochemical plants</li> <li>• Suitable for outdoor use under harsh, dusty ambient conditions</li> <li>• Especially suitable for quarter turn actuators thanks to NAMUR flange pattern</li> <li>• Variants with TÜV approval up to SIL3 acc. to IEC 61508</li> </ul>	<ul style="list-style-type: none"> <li>• Suitable for process automation, for applications in chemical and petrochemical plants</li> <li>• Suitable for outdoor use under harsh, dusty ambient conditions</li> <li>• Especially suitable for quarter turn actuators thanks to NAMUR flange pattern</li> <li>• Valve can switch between internal and external pilot air</li> <li>• Variants with TÜV approval up to SIL3 acc. to IEC 61508</li> </ul>	<ul style="list-style-type: none"> <li>• Directly actuated poppet valve</li> <li>• Fast-switching valve: switching times down to 2 ms</li> <li>• Direct mounting, individual sub-base, manifold assembly</li> <li>• Manifold block for 2 ... 10 valves</li> </ul>	<ul style="list-style-type: none"> <li>• Directly actuated poppet valve</li> <li>• Identical basic valves for direct mounting or manifold installation</li> <li>• Individual valve with integrated QS fitting</li> <li>• Switching frequencies up to 1000 Hz</li> <li>• Service life &gt; 5 billion switching cycles</li> <li>• Very good reproducibility</li> <li>• MHJ9: Valve manifold assembly with individual outputs or with air nozzle output</li> <li>• MHJ9: Electrical connection via connecting cable MHJ9-KMH with integrated control electronics</li> <li>• MHJ10: Valve manifold assembly with individual outputs</li> <li>• MHJ10: Electrical connection via moulded-in cable, control electronics included in the valve</li> </ul>
<b>→ Page/online</b>	<a href="#">vofd</a>	<a href="#">vofc</a>	<a href="#">mh2</a>	<a href="#">mhj9</a>

## Manually actuated directional control valves: swivel lever valves



	 Hand lever valves VHEF-HS	 Hand lever valves VHEF, NPT thread	 Hand lever valves VHER	 Hand lever valves VHER, NPT thread
<b>Valve function</b>	3/2-way bistable, 3/2-way open/closed monostable, 5/2-way bistable, 5/2-way monostable, 5/3-way exhausted, 5/3-way closed	3/2-way bistable, 3/2-way open/closed monostable, 5/2-way bistable, 5/2-way monostable, 5/3-way exhausted, 5/3-way closed	4/3-way pressurised, 4/3-way exhausted, 4/3-way closed	4/3-way exhausted, 4/3-way closed
<b>Type of control</b>	Direct	Direct	Direct	Direct
<b>Standard nominal flow rate</b>	530 ... 1200 l/min	530 ... 1200 l/min	170 ... 3800 l/min	600 ... 3800 l/min
<b>Pneumatic working port</b>	G1/4, G1/8	NPT1/4, NPT1/4-18, NPT1/8, NPT1/8-27	G1/2, G1/4, G1/8, M5	NPT1/2-14, NPT1/4-18, NPT1/8-27
<b>Operating pressure</b>	-0.95 ... 10 bar	-0.95 ... 10 bar	0 ... 10 bar	0 ... 10 bar
<b>Description</b>	<ul style="list-style-type: none"> <li>• With hand lever on the side or on top</li> <li>• Durable thanks to tried-and-tested piston spool and disc seat valve technology</li> <li>• Sturdy metal housing</li> <li>• Attractively priced</li> <li>• Ergonomic and safe operation</li> <li>• Low actuating forces</li> <li>• Modern design</li> <li>• Reverse operation possible</li> </ul>	<ul style="list-style-type: none"> <li>• With hand lever on the side or on top</li> <li>• Durable thanks to tried-and-tested piston spool and disc seat valve technology</li> <li>• Sturdy metal housing</li> <li>• Attractively priced</li> <li>• Ergonomic and safe operation</li> <li>• Low actuating forces</li> <li>• Modern design</li> <li>• Reverse operation possible</li> </ul>	<ul style="list-style-type: none"> <li>• Lever in metal or polymer design</li> <li>• Front panel mounting, through-holes or mounting holes</li> </ul>	<ul style="list-style-type: none"> <li>• Lever in metal or polymer design</li> <li>• Front panel mounting, through or mounting holes</li> </ul>
<b>→ Page/online</b>	<a href="#">vhf</a>	<a href="#">vhf</a>	<a href="#">vher</a>	<a href="#">vher</a>

## Manually actuated directional control valves: pushbutton valves



	 Pushbutton valves VHEF-P	 Pushbutton valves VHEF-P, NPT thread	 Pushbutton valves VHEM-P
<b>Valve function</b>	3/2-way bistable, 3/2-way open/closed monostable, 5/2-way bistable, 5/2-way monostable	3/2-way bistable, 3/2-way open/closed monostable, 5/2-way bistable, 5/2-way monostable	3/2-way closed monostable, 3/2-way open monostable, 5/2-way bistable, 5/2-way monostable
<b>Type of control</b>	Direct, pilot-controlled	Direct, pilot-controlled	Direct, pilot-controlled
<b>Standard nominal flow rate</b>	750 ... 1200 l/min	750 ... 1200 l/min	500 ... 1000 l/min
<b>Pneumatic working port</b>	G1/4, G1/8	NPT1/4-18, NPT1/8-27	G1/4, G1/8
<b>Operating pressure</b>	-0.95 ... 10 bar	-0.95 ... 10 bar	-0.95 ... 10 bar
<b>Description</b>	<ul style="list-style-type: none"> <li>• With button switch</li> <li>• Durable thanks to tried-and-tested piston spool and disc seat valve technology</li> <li>• Sturdy metal housing</li> <li>• Attractively priced</li> <li>• Ergonomic and safe operation</li> <li>• Low actuating forces</li> <li>• Modern design</li> <li>• Reverse operation possible</li> </ul>	<ul style="list-style-type: none"> <li>• With button switch</li> <li>• Durable thanks to tried-and-tested piston spool and disc seat valve technology</li> <li>• Sturdy metal housing</li> <li>• Attractively priced</li> <li>• Ergonomic and safe operation</li> <li>• Low actuating forces</li> <li>• Modern design</li> <li>• Reverse operation possible</li> </ul>	<ul style="list-style-type: none"> <li>• With button switch</li> <li>• Reverse operation possible</li> </ul>
<b>→ Page/online</b>	<a href="#">vhf</a>	<a href="#">vhf</a>	<a href="#">vhem-p</a>

Product overview

Manually actuated directional control valves: finger lever valves



	 Finger lever valves VHEF-L	 Finger lever valves VHEF-L, NPT thread
<b>Valve function</b>	3/2-way open/closed monostable, 5/2-way monostable	3/2-way open/closed monostable, 5/2-way monostable
<b>Type of control</b>	Direct	Direct
<b>Standard nominal flow rate</b>	750 ... 1200 l/min	750 ... 1200 l/min
<b>Pneumatic working port</b>	G1/4, G1/8	NPT1/4-18, NPT1/8-27
<b>Operating pressure</b>	-0.95 ... 10 bar	-0.95 ... 10 bar
<b>Description</b>	<ul style="list-style-type: none"> <li>• With finger lever</li> <li>• Durable thanks to tried-and-tested piston spool and disc seat valve technology</li> <li>• Sturdy metal housing</li> <li>• Attractively priced</li> <li>• Ergonomic and safe operation</li> <li>• Low actuating forces</li> <li>• Modern design</li> <li>• Reverse operation possible</li> </ul>	<ul style="list-style-type: none"> <li>• With finger lever</li> <li>• Durable thanks to tried-and-tested piston spool and disc seat valve technology</li> <li>• Sturdy metal housing</li> <li>• Attractively priced</li> <li>• Ergonomic and safe operation</li> <li>• Low actuating forces</li> <li>• Modern design</li> <li>• Reverse operation possible</li> </ul>
<b>→ Page/online</b>	<a href="#">vhf</a>	<a href="#">vhf</a>

Manually operated directional control valves: selector switches



	 Selector valves VHEF-ES	 Selector valves VHEF, NPT thread
<b>Valve function</b>	3/2-way bistable, 3/2-way open/closed monostable, 5/2-way bistable, 5/2-way monostable, 5/3-way exhausted, 5/3-way closed	3/2-way bistable, 3/2-way open/closed monostable, 5/2-way bistable, 5/2-way monostable, 5/3-way exhausted, 5/3-way closed
<b>Type of control</b>	Direct	Direct
<b>Standard nominal flow rate</b>	530 ... 1200 l/min	530 ... 1200 l/min
<b>Pneumatic working port</b>	G1/4, G1/8	NPT1/4, NPT1/4-18, NPT1/8, NPT1/8-27
<b>Operating pressure</b>	-0.95 ... 10 bar	-0.95 ... 10 bar
<b>Description</b>	<ul style="list-style-type: none"> <li>• With selector switch on the side or on top</li> <li>• Durable thanks to tried-and-tested piston spool and disc seat valve technology</li> <li>• Sturdy metal housing</li> <li>• Attractively priced</li> <li>• Ergonomic and safe operation</li> <li>• Low actuating forces</li> <li>• Modern design</li> <li>• Reverse operation possible</li> </ul>	<ul style="list-style-type: none"> <li>• With selector switch on the side or on top</li> <li>• Durable thanks to tried-and-tested piston spool and disc seat valve technology</li> <li>• Sturdy metal housing</li> <li>• Attractively priced</li> <li>• Ergonomic and safe operation</li> <li>• Low actuating forces</li> <li>• Modern design</li> <li>• Reverse operation possible</li> </ul>
<b>→ Page/online</b>	<a href="#">vhf</a>	<a href="#">vhf</a>



## Mechanically operated directional control valves: stem actuated valves



	 Stem actuated valves VMEF-S	 Stem actuated valves VMEF-S, NPT thread
<b>Valve function</b>	3/2-way closed monostable, 5/2-way monostable	5/2-way monostable
<b>Type of control</b>	Direct, pilot-controlled	Piloted
<b>Standard nominal flow rate</b>	750 ... 1200 l/min	750 ... 1200 l/min
<b>Pneumatic working port</b>	G1/4, G1/8	NPT1/4-18, NPT1/8-27
<b>Operating pressure</b>	-0.95 ... 10 bar	-0.95 ... 10 bar
<b>Description</b>	<ul style="list-style-type: none"> <li>• Durable thanks to tried-and-tested piston spool and disc seat valve technology</li> <li>• Sturdy metal housing</li> <li>• Outstanding pneumatic performance</li> <li>• Attractively priced</li> <li>• Ergonomic and safe operation</li> <li>• Low actuating forces</li> <li>• Modern design</li> <li>• Reverse operation possible</li> </ul>	<ul style="list-style-type: none"> <li>• Durable thanks to tried-and-tested piston spool and disc seat valve technology</li> <li>• Sturdy metal housing</li> <li>• Outstanding pneumatic performance</li> <li>• Attractively priced</li> <li>• Ergonomic and safe operation</li> <li>• Low actuating forces</li> <li>• Modern design</li> <li>• Reverse operation possible</li> </ul>
<b>→ Page/online</b>	<a href="#">vmef</a>	<a href="#">vmef</a>

## Mechanically operated directional control valves: roller lever valves

	 Roller lever valves VMEF-R	 Roller lever valves VMEF-R, NPT thread
<b>Valve function</b>	3/2-way monostable, 5/2-way monostable	3/2-way monostable, 5/2-way monostable
<b>Type of control</b>	Direct	Direct
<b>Standard nominal flow rate</b>	750 ... 1200 l/min	750 ... 1200 l/min
<b>Pneumatic working port</b>	G1/4, G1/8	NPT1/4, NPT1/8
<b>Operating pressure</b>	-0.95 ... 10 bar	-0.95 ... 10 bar
<b>Description</b>	<ul style="list-style-type: none"> <li>• Durable thanks to tried-and-tested piston spool and disc seat valve technology</li> <li>• Sturdy metal housing</li> <li>• Outstanding pneumatic performance</li> <li>• Attractively priced</li> <li>• Ergonomic and safe operation</li> <li>• Low actuating forces</li> <li>• Modern design</li> <li>• Reverse operation possible</li> </ul>	<ul style="list-style-type: none"> <li>• Durable thanks to tried-and-tested piston spool and disc seat valve technology</li> <li>• Sturdy metal housing</li> <li>• Outstanding pneumatic performance</li> <li>• Attractively priced</li> <li>• Ergonomic and safe operation</li> <li>• Low actuating forces</li> <li>• Modern design</li> <li>• Reverse operation possible</li> </ul>
<b>→ Page/online</b>	<a href="#">vmef</a>	<a href="#">vmef</a>

Product overview



Mechanically operated directional control valves: roller lever valves

	 Roller lever valves VMEF-K	 Roller lever valves VMEF-K, NPT thread
<b>Valve function</b>	3/2-way monostable, 5/2-way monostable	3/2-way monostable, 5/2-way monostable
<b>Type of control</b>	Direct	Direct
<b>Standard nominal flow rate</b>	750 ... 1200 l/min	750 ... 1200 l/min
<b>Pneumatic working port</b>	G1/4, G1/8	NPT1/4, NPT1/8
<b>Operating pressure</b>	-0.95 ... 10 bar	-0.95 ... 10 bar
<b>Description</b>	<ul style="list-style-type: none"> <li>• Durable thanks to tried-and-tested piston spool and disc seat valve technology</li> <li>• Sturdy metal housing</li> <li>• Outstanding pneumatic performance</li> <li>• Attractively priced</li> <li>• Ergonomic and safe operation</li> <li>• Low actuating forces</li> <li>• Modern design</li> <li>• Reverse operation possible</li> </ul>	<ul style="list-style-type: none"> <li>• Durable thanks to tried-and-tested piston spool and disc seat valve technology</li> <li>• Sturdy metal housing</li> <li>• Outstanding pneumatic performance</li> <li>• Attractively priced</li> <li>• Ergonomic and safe operation</li> <li>• Low actuating forces</li> <li>• Modern design</li> <li>• Reverse operation possible</li> </ul>
<b>→ Page/online</b>	<a href="#">vmef</a>	<a href="#">vmef</a>



Check valves and quick exhaust valves

	 Check valves, piloted HGL
<b>Pneumatic connection 1</b>	G1/2, G1/4, G1/8, G3/8, M5, QS-10, QS-12, QS-4, QS-6, QS-8
<b>Standard nominal flow rate 1 → 2 from 6 to 5 bar</b>	130 ... 1600 l/min
<b>Operating pressure</b>	0.5 ... 10 bar
<b>Description</b>	<ul style="list-style-type: none"> <li>• Valve function: piloted non-return function</li> <li>• Pneumatically piloted</li> <li>• Screw-in with male thread</li> <li>• Pilot air connection: M5, G1/8, G1/4, G3/8, QS-4</li> <li>• Manually actuated exhaust possible with separate accessories</li> </ul>
<b>→ Page/online</b>	<a href="#">108</a>

## Ball valves and shut-off valves



	 <b>Hand slide valves</b> <b>VBOH</b>	 <b>Ball valves</b> <b>QH-QS, QHS-QS</b>
<b>Valve function</b>	3/2-way, bistable	2/2-way, bistable
<b>Pneumatic connection 1</b>	G1/2, G1/4, G1/8, G3/4, G3/8, M5	QS-4, QS-6, R1/8
<b>Standard nominal flow rate</b>	236 ... 7691 l/min	148 ... 560 l/min
<b>Operating pressure</b>	-0.95 ... 12 bar	-1 ... 10 bar
<b>Description</b>	<ul style="list-style-type: none"> <li>Used as a shut-off function for pressurising and exhausting compressed air systems, e.g. upstream of service unit combinations, for air guns and also for exhausting pneumatic cylinders</li> <li>Non-overlapping, so no pressure losses when switching</li> <li>Minimal installation effort</li> </ul>	<ul style="list-style-type: none"> <li>Shut-off valve, manually operated</li> <li>In-line installation, can be screwed in, bulkhead fitting</li> <li>Variants: thread at both ends, push-in connector at both ends, thread/push-in connector</li> </ul>
<b>→ Page/online</b>	<a href="#">vboh</a>	<a href="#">qh</a>

## One-way flow control valves



	 <b>One-way flow control valves</b> <b>GRLA, GRLZ</b>	 <b>One-way flow control valves</b> <b>VFOF</b>
<b>Valve function</b>	Exhaust air one-way flow control function, one-way flow control function, supply air one-way flow control function	Exhaust air one-way flow control function
<b>Pneumatic connection 1</b>	G1/2, G1/4, G1/8, G3/4, G3/8, M3, M5, PK-3, PK-3 with union nut, PK-4, PK-4 with union nut, PK-6 with union nut, QS-10, QS-12, QS-3, QS-4, QS-6, QS-8	QS-6, QS-8
<b>Standard nominal flow rate in flow control direction</b>	0 ... 4320 l/min	240 ... 590 l/min
<b>Adjusting element</b>	Knurled screw, slotted head screw, internal hex	Internal hex
<b>Description</b>	<ul style="list-style-type: none"> <li>Flow control valve, flow control at one end</li> <li>Polymer, metal or stainless steel design</li> <li>Standard, mini, in-line variants with different flow rates</li> <li>Functional combination of one-way flow control valve and piloted check valve</li> <li>Connections: thread at both ends, push-in connector at both ends, thread/push-in connector</li> </ul>	<ul style="list-style-type: none"> <li>Functional combination of one-way flow control valve and piloted check valve</li> <li>High flow rate</li> <li>Can be rotated horizontally through 360° when mounted</li> <li>Compact and can be operated from the side</li> </ul>
<b>→ Page/online</b>	<a href="#">109</a>	<a href="#">vfof</a>

Product overview



Proportional valves

	 Proportional pressure regulators VPPM	 Proportional pressure regulators VPPE
<b>Valve function</b>	3-way proportional pressure regulator	3-way proportional pressure regulator, 3-way proportional pressure regulator, closed
<b>Pneumatic connection 1</b>	Sub-base, G1/2, G1/4, G1/8	G1/8
<b>Pressure regulation range</b>	0.02 ... 10 bar	0.02 ... 10 bar
<b>Operating pressure</b>		8 bar
<b>Standard nominal flow rate</b>	380 ... 7000 l/min	310 ... 1250 l/min
<b>Description</b>	<ul style="list-style-type: none"> <li>• Piloted pressure regulator</li> <li>• Multi-sensor control (cascade control)</li> <li>• Integration in valve terminal MPA</li> <li>• User interface with LED displays, LCD display, adjustment/selection buttons</li> <li>• Integrated pressure sensor</li> <li>• Electrical connection via plug, round design, 8-pin, M12 or terminal linking</li> </ul>	<ul style="list-style-type: none"> <li>• Piloted pressure regulator</li> <li>• Setpoint input as analogue voltage signal (0 ... 10 V)</li> <li>• Electrical connection via M12x1 plug, 4-pin</li> <li>• Optionally with setpoint module</li> <li>• For simple control tasks</li> </ul>
<b>→ Page/online</b>	<a href="#">vppm</a>	<a href="#">vppe</a>



Solenoid actuated process and media valves

	 Solenoid valves VZWD	 Solenoid valves VZWF	 Solenoid valves VZWM
<b>Design</b>	Directly actuated poppet valve	Diaphragm valve, force pilot operated	Poppet valve with diaphragm seal
<b>Actuation type</b>	Electrical	Electrical	Electrical
<b>Nominal width</b>	1 ... 6 mm	13.5 ... 50 mm	13 ... 50 mm
<b>Flow rate Kv</b>	0.06 ... 0.4 m³/h	1.8 ... 28 m³/h	1.6 ... 39 m³/h
<b>Temperature of medium</b>	-10 ... 80°C	-10 ... 80°C	-10 ... 60°C
<b>Medium pressure</b>	0 ... 90 bar	0 ... 10 bar	
<b>Process valve connection</b>	1/4 NPT, 1/8 NPT, G1/4, G1/8, NPT1/4	1 NPT, 1 1/2 NPT, 1 1/4 NPT, 1/2 NPT, 1/4 NPT, 2 NPT, 3/4 NPT, 3/8 NPT, G1, G1 1/2, G1 1/4, G1/2, G1/4, G2, G3/4, G3/8, NPT1, NPT1 1/2, NPT1 1/4, NPT1/2, NPT1/4, NPT2, NPT3/4, NPT3/8	G1, G1 1/2, G1 1/4, G1/2, G1/4, G2, G3/4, G3/8
<b>Description</b>	<ul style="list-style-type: none"> <li>• Large pressure range</li> <li>• Directly actuated poppet valve</li> <li>• No pressure difference required</li> <li>• Can also be used in vacuum technology</li> </ul>	<ul style="list-style-type: none"> <li>• High flow rates</li> <li>• Large nominal diameters with relatively small solenoids</li> <li>• No pressure difference required</li> <li>• Can also be used in vacuum technology</li> </ul>	<ul style="list-style-type: none"> <li>• Brass or stainless steel casting design</li> <li>• Electrical connection via solenoid armature tube</li> <li>• Wide range of coils</li> <li>• Coil can be ordered separately</li> </ul>
<b>→ Page/online</b>	<a href="#">213</a>	<a href="#">214</a>	<a href="#">215</a>

## Solenoid actuated process and media valves



	 <b>Reverse jet pulse valves</b> VZWE-E, VZWE-F	 <b>Solenoid valves</b> VZWP
<b>Design</b>	Angled version, straight version with flange, diaphragm valve	Piloted piston poppet valve
<b>Actuation type</b>	Electrical	Electrical
<b>Nominal width</b>	20 ... 76 mm	13 ... 25 mm
<b>Flow rate Kv</b>	15 ... 210 m³/h	1.5 ... 11.5 m³/h
<b>Temperature of medium</b>		-10 ... 80°C
<b>Medium pressure</b>	0.35 ... 8 bar	0.5 ... 40 bar
<b>Process valve connection</b>		1 NPT, 1/2 NPT, 1/4 NPT, 3/4 NPT, 3/8 NPT, G1, G1/2, G1/4, G3/4, G3/8
<b>Description</b>	<ul style="list-style-type: none"> <li>• High flow rates</li> <li>• For mechanically cleaning filters and dust filter systems</li> <li>• Fast opening and closing times</li> <li>• Sturdy pilot system</li> </ul>	<ul style="list-style-type: none"> <li>• For all applications with a differential pressure of min. 0.5 bar</li> <li>• For high pressures and high flow rates with relatively small solenoids</li> <li>• For controlling gaseous and liquid media in open circuits</li> </ul>
<b>→ Page/online</b>	<a href="#">vzwe</a>	<a href="#">vzwp</a>

## Pneumatically and mechanically actuated process and media valves

	 <b>Angle seat valves</b> VZXF	 <b>Pinch valves</b> VZQA	 <b>Ball valves</b> VZBA
<b>Design</b>	Piston actuator with poppet valve	Pinch valve, pneumatically actuated	2-way ball valve, 3-way ball valve, L-shaped hole, T-shaped hole
<b>Valve function</b>	2/2-way, monostable, closed	2/2-way, monostable, closed, 2/2-way, monostable, open	2/2, 3/2
<b>Actuation type</b>	Pneumatic	Pneumatic	Mechanical
<b>Nominal width</b>	12 ... 45 mm		
<b>Nominal width DN</b>		6, 15, 25	8, 10, 15, 20, 25, 32, 40, 50, 65, 80, 100
<b>Process valve connection</b>		Clamp to ASME-BPE type A, clamp to ASME-BPE type B, clamp to DIN 32676 series A, 1 NPT, 1/2 NPT, 1/4 NPT, G1, G1/2, G1/4	Weld-on ends/weld-on ends, Rp1, Rp1 1/2, Rp1 1/4, Rp1/2, Rp1/4, Rp2, Rp2 1/2, Rp3, Rp3/4, Rp3/8, Rp4
<b>Flow rate Kv</b>	3.3 ... 43 m³/h	0.7 ... 18 m³/h	7 ... 1414 m³/h
<b>Temperature of medium</b>	-40 ... 200°C	-15 ... 150°C	-10 ... 200°C
<b>Medium pressure</b>	-0.9 ... 40 bar	0 ... 6 bar	
<b>Process valve PN nominal pressure</b>	16 ... 40	10	63
<b>Description</b>	<ul style="list-style-type: none"> <li>• Sturdy design</li> <li>• Stainless steel and gunmetal (red brass) process valves with stainless steel, brass or aluminium actuators</li> <li>• Safety position "closing"</li> <li>• Different actuator sizes and housing materials</li> <li>• Selection of different seat and shaft seals</li> <li>• Flow direction is freely selectable</li> <li>• For liquids, gases and other easily contaminated media</li> <li>• Easy-to-clean design</li> </ul>	<ul style="list-style-type: none"> <li>• Modular design</li> <li>• Quick and easy replacement of the diaphragm</li> <li>• Selection of different materials for housing and connection caps</li> <li>• Different connection cap designs (G and NPT thread, clamp ferrule to DIN 32676 and ASME-BPE)</li> <li>• For critical, abrasive and viscous media</li> <li>• Up to 2 million switching cycles</li> <li>• FDA-compliant materials</li> <li>• Easy-to-clean design</li> <li>• Flow direction is freely selectable</li> </ul>	<ul style="list-style-type: none"> <li>• Automatable 2-way or 3-way ball valve</li> <li>• Stainless steel design</li> <li>• Blow-out proof shaft</li> <li>• Manual operation possible using hand lever</li> <li>• Connecting thread to EN 10226-1</li> <li>• Mounting flange to ISO 5211</li> <li>• Use in zone 1, 21, 2, 22</li> </ul>
<b>→ Page/online</b>	<a href="#">211</a>	<a href="#">vzqa</a>	<a href="#">vzba</a>

Product overview

Pneumatically and mechanically actuated process and media valves

	 Ball valve actuator units VZBA	 Ball valve actuator units VZBM
<b>Design</b>	2-way ball valve, 3-way ball valve, L-shaped hole, quarter turn actuator, T-shaped hole	2-way ball valve, 3-way ball valve, quarter turn actuator
<b>Valve function</b>		
<b>Actuation type</b>	Pneumatic	Pneumatic
<b>Nominal width</b>		
<b>Nominal width DN</b>	8, 10, 15, 20, 25, 32, 40, 50, 65, 80, 100	8, 10, 15, 20, 25, 32, 40, 50
<b>Process valve connection</b>	Weld-on ends/weld-on ends, Rp1, Rp1 1/2, Rp1 1/4, Rp1/2, Rp1/4, Rp2, Rp2 1/2, Rp3, Rp3/4, Rp3/8, Rp4	Rp1, Rp1 1/2, Rp1 1/4, Rp1/2, Rp1/4, Rp2, Rp3/4, Rp3/8
<b>Flow rate Kv</b>	7 ... 1414 m³/h	5.9 ... 243 m³/h
<b>Temperature of medium</b>	-10 ... 200°C	-20 ... 130°C
<b>Medium pressure</b>		
<b>Process valve PN nominal pressure</b>	63	25 ... 40
<b>Description</b>	<ul style="list-style-type: none"> <li>• Ball valve actuator unit with double-acting or single-acting quarter turn actuator DAPS</li> <li>• Stainless steel ball valve</li> <li>• Connection pattern to NAMUR for solenoid valves/sensor boxes to VDI/VDE 3845</li> <li>• Flow is fully opened or closed in both directions</li> <li>• Use in zone 1, 21, 2, 22</li> </ul>	<ul style="list-style-type: none"> <li>• Ball valve actuator unit with double-acting or single-acting quarter turn actuator DFPD</li> <li>• Brass ball valve</li> <li>• 2-way ball valve actuator unit with pipe thread to EN 10226-1</li> <li>• 3-way ball valve actuator unit with L-shaped hole and pipe thread to EN 10226-1</li> <li>• 3-way ball valve actuator unit with T-shaped hole and pipe thread to EN 10226-1</li> <li>• Flow is fully opened or closed in both directions</li> </ul>
<b>→ Page/online</b>	<a href="#">vzba</a>	<a href="#">vzbm</a>

Customised components – for your specific requirements

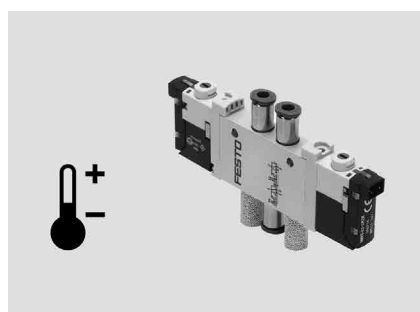

Valves with customised designs

Can't find the valve you need in our catalogue?

We can offer you customised components that are tailored to your specific requirements.

Common product modifications:

- Coatings for special ambient conditions
- Customised cables: length, pin allocation, pre-assembled with plug
- Modified actuating elements
- Modified connecting thread
- Modified valve sub-bases

Many additional variants are possible.

Ask your Festo sales engineer, who will be happy to help:

→ [www.festo.com/contact](http://www.festo.com/contact)

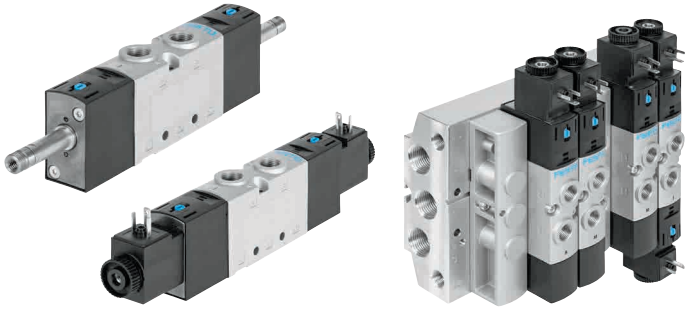

- Width of valves 20 (21 mm), 25 (26.5 mm), 30 (31 mm), flow rate up to 2300 l/min
- In-line valves can be used as individual valves or manifold valves
- Variable pressure zones
- Universal valve, sturdy and durable
- Low-cost, no limitations with regard to performance
- Can be used as a valve manifold VTUS

## Order code – Basic design

001 002 003 004 005 006 007 008 009 010 011 012 013 014  
 VUVS - L - - - - - D - - - - 1 - - - -

001	Type
VUVS	Solenoid valve
002	Valve type
L	In-line valve
003	Design principle
-	Piston spool with sealing cartridge
K	Piston spool with sealing ring
004	Size
20	Valve width 21 mm
25	Valve width 26.5 mm
30	Valve width 31 mm
005	Valve functions
B52	5/2-way valve, double solenoid
M52	5/2-way valve, single solenoid
P53C	5/3-way valve, mid-position closed
M32C	3/2-way valve, single solenoid, normally closed
006	Reset method
-	Without, for valve function B52
A	Pneumatic spring, for valve function M32 and M52
M	Mechanical spring, for valve function M32, M52 and P53
007	Pilot air supply
-	Internal

008	Manual override
D	Non-detenting, detenting
009	Pneumatic connection
G18	G1/8 thread
G14	Thread G1/4
G38	G3/8 thread
010	Exhaust
-	No fitting
011	Valve pilot control interface
-	Standard
F7	With 8 mm armature tube, short
F8	With 8 mm armature tube, long
012	Nominal operating voltage
1	24 V DC
013	Electrical connection
C1	Connection pattern type C, to EN 175301
B2	Connection pattern type B, industry standard
014	Version
-	Extended features
S	Core features

Legend:  Mandatory entry  Optional entry

## Product options

### Valve functions:

M32U 3/2-way valve, single solenoid, open  
 P53U 5/3-way valve, pressurised  
 P53E 5/3-way valve, exhausted  
 T32... 2x 3/2-way valve

### Pilot air supply:

Z External

### Manual override:

S Covered  
 H Non-detenting

### Pneumatic connection:

Push-in connector 4 ... 12 mm

### Exhaust:

QN With fitting  
 U Silencer

### Nominal operating voltage:

24 V AC, 230 V AC, 230/240 V AC, 12 V DC, 110/120 V AC

### Degree of protection for electrics:

S8 IP67

## Ordering – Product options

Configurable product

This product and all its product options can be ordered online via the configurator:

→ [www.festo.com/catalogue/vuvs-l](http://www.festo.com/catalogue/vuvs-l)

Electrically and pneumatically actuated directional control valves > Universal directional control valves >

Solenoid valves VUVS ★

Ordering – Basic design

014 Core features				
004 Size	Type	Part no.	Type	Part no.
<b>3/2-way valves</b>				
013 Connection pattern type C, to EN 175 301, 002 In-line valve, 003 Piston spool with sealing ring, 011 With standard valve pilot control interface				
	005 3/2-way, normally closed			
	006 Pneumatic spring			
20 (valve width 21 mm)	VUVS-LK20-M32C-AD-G18-1C1-S	★ 8043213		
013 Connection pattern type B, industry standard, 002 In-line valve, 003 Piston spool with sealing ring, 011 With standard valve pilot control interface				
	005 3/2-way, normally closed			
	006 Pneumatic spring			
25 (valve width 26.5 mm)	VUVS-LK25-M32C-AD-G14-1B2-S	★ 8043217		
30 (valve width 31 mm)	VUVS-LK30-M32C-AD-G38-1B2-S	★ 8049880		
<b>5/2-way valves</b>				
013 Connection pattern type C, to EN 175 301, 002 In-line valve, 003 Piston spool with sealing ring, 011 With standard valve pilot control interface				
	005 5/2-way, single solenoid		005 5/2-way, double solenoid	
	006 Pneumatic spring		006 –	
20 (valve width 21 mm)	VUVS-LK20-M52-AD-G18-1C1-S	★ 8043214	VUVS-LK20-B52-D-G18-1C1-S	★ 8043215
013 Connection pattern type B, industry standard, 002 In-line valve, 003 Piston spool with sealing ring, 011 With standard valve pilot control interface				
	005 5/2-way, double solenoid		005 5/2-way, single solenoid	
	006 –		006 Pneumatic spring	
25 (valve width 26.5 mm)	VUVS-LK25-B52-D-G14-1B2-S	★ 8043219	VUVS-LK25-M52-AD-G14-1B2-S	★ 8043218
30 (valve width 31 mm)	VUVS-LK30-B52-D-G38-1B2-S	★ 8049882	VUVS-LK30-M52-AD-G38-1B2-S	★ 8049881
<b>014 Extended features</b>				
004 Size	Type	Part no.	Type	Part no.
<b>3/2-way valves</b>				
013 Connection pattern type C, to EN 175 301, 002 In-line valve, 003 Piston spool with sealing cartridge, 011 With armature tube valve pilot control interface				
	005 3/2-way, normally closed		005 3/2-way, normally closed	
	006 Mechanical spring		006 Pneumatic spring	
20 (valve width 21 mm)	VUVS-L20-M32C-MD-G18-F7-1C1	★ 575274		
25 (valve width 26.5 mm)	VUVS-L25-M32C-MD-G14-F8-1C1	★ 575477	VUVS-L25-M32C-AD-G14-F8-1C1	★ 575475
30 (valve width 31 mm)	VUVS-L30-M32C-MD-G38-F8-1C1	★ 575570	VUVS-L30-M32C-AD-G38-F8-1C1	★ 575568
	005 5/2-way, single solenoid		005 5/2-way, double solenoid	
	006 Pneumatic spring		006 –	
20 (valve width 21 mm)	VUVS-L20-M52-AD-G18-F7-1C1	★ 575263		
25 (valve width 26.5 mm)	VUVS-L25-M52-AD-G14-F8-1C1	★ 575503	VUVS-L25-B52-D-G14-F8-1C1	★ 575518
30 (valve width 31 mm)	VUVS-L30-M52-AD-G38-F8-1C1	★ 575596	VUVS-L30-B52-D-G38-F8-1C1	★ 575611
<b>5/2-way valves</b>				
013 Connection pattern type C, to EN 175 301, 002 In-line valve, 003 Piston spool with sealing cartridge, 011 With armature tube valve pilot control interface				
	005 5/2-way, single solenoid			
	006 Mechanical spring			
20 (valve width 21 mm)	VUVS-L20-M52-MD-G18-F7-1C1	★ 575264		
25 (valve width 26.5 mm)	VUVS-L25-M52-MD-G14-F8-1C1	★ 575511		
30 (valve width 31 mm)	VUVS-L30-M52-MD-G38-F8-1C1	★ 575604		
	005 5/3-way, mid-position closed			
	006 Mechanical spring			
20 (valve width 21 mm)	VUVS-L20-P53C-MD-G18-F7-1C1	★ 575268		
25 (valve width 26.5 mm)	VUVS-L25-P53C-MD-G14-F8-1C1	★ 575525		
30 (valve width 31 mm)	VUVS-L30-P53C-MD-G38-F8-1C1	★ 575618		



## Accessories

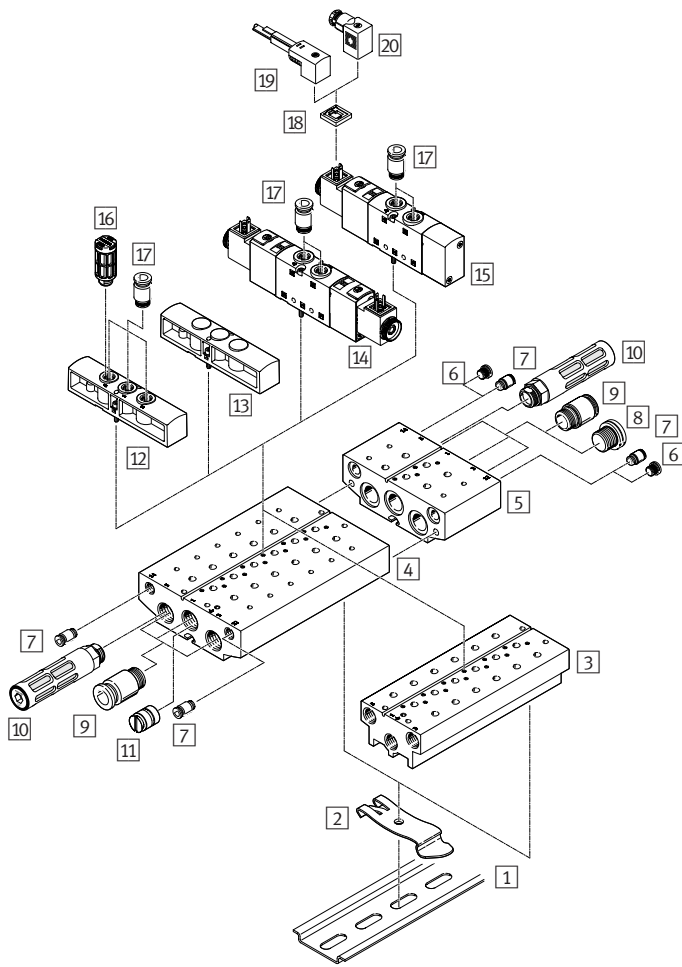

- 1 H-rail NRH-35-2000 → nrh-35
  - 2 H-rail mounting VAME-T-M4 → vuvs-l
  - 3 Manifold block, compact VABM-B10-20S → 96
  - 4 Manifold block, standard VABM-B10-20E → vuvs-l
  - 5 Extension module for standard manifold block VABM-B10-20EEE → vuvs-l
  - 6 Blanking plug B with connecting thread → 173
  - 7 Push-in fitting QS → 168
  - 8 Blanking plug B with connecting thread → 173
  - 9 Push-in fitting QS → 168
  - 10 Silencer U → 192, silencer AMTE → 191
  - 11 Separator VABD → vuvs-l
  - 12 Supply plate VABF-B10 → vuvs-l
  - 13 Blanking plate VABB-B10 → 95
  - 14 Solenoid valve VUVS, 5/3-way valve and 5/2-way valve, double solenoid, with solenoid coil
  - 15 Solenoid valve VUVS, 5/2-way valve, single solenoid, with solenoid coil
  - 16 Silencer U → 192, silencer AMTE → 191
  - 17 Push-in fitting QS → 168
  - 18 Illuminating seal MEB-LD → vuvs-l
  - 19 Plug socket with cable KMEB → 96  
Plug socket with cable KMF → 96
  - 20 Plug socket MSSD → 96
- Cover cap VAMC-B10 → 96  
Solenoid coil VACS-C, VACF-B → vuvs-l

## 13 Blanking plate VABB-B10

Description	Type	Part no.
For valve position on manifold block for 3/2-way valves		
Size 20	VABB-B10-20-E-P3	★ 576411
Size 25	VABB-B10-25-E-P3	★ 8026210
Size 30	VABB-B10-30-E-P3	★ 8026336
For valve position on manifold block for 5/2-way, 5/3-way valves		
Size 20	VABB-B10-20-E	★ 576410
Size 25	VABB-B10-25-E	★ 8026209
Size 30	VABB-B10-30-E	★ 8026335
For valve position on supply manifold		
Size 20	VABB-B10-20-A	★ 576409
Size 25	VABB-B10-25-A	★ 8026208
Size 30	VABB-B10-30-A	★ 8026334

Electrically and pneumatically actuated directional control valves > Universal directional control valves >

Solenoid valves VUVS ★

Accessories

13 Manifold block, compact VABM-B10-20S/VABM-B10-25S				
Size	Pneumatic connection	Valve positions	Type	Part no.
For 3/2-way valves, incl. seals and screws for mounting valves				
20 (21 mm)	G1/4	2	VABM-B10-20S-G14-2-P3	★ 576465
		4	VABM-B10-20S-G14-4-P3	★ 576467
		6	VABM-B10-20S-G14-6-P3	★ 576469
		8	VABM-B10-20S-G14-8-P3	★ 576471
		10	VABM-B10-20S-G14-10-P3	★ 576473
25 (26,5 mm)	G3/8	2	VABM-B10-25S-G38-2-P3	★ 8026297
		4	VABM-B10-25S-G38-4-P3	★ 8026299
		6	VABM-B10-25S-G38-6-P3	★ 8026301
		8	VABM-B10-25S-G38-8-P3	★ 8026303
		10	VABM-B10-25S-G38-10-P3	★ 8026305
30 (31 mm)	G1/2	2	VABM-B10-30S-G12-2-P3	★ 8026413
		4	VABM-B10-30S-G12-4-P3	★ 8026415
		6	VABM-B10-30S-G12-6-P3	★ 8026417
		8	VABM-B10-30S-G12-8-P3	★ 8026419
		10	VABM-B10-30S-G12-10-P3	★ 8026421
For 5/2-way and 5/3-way valves, incl. seals and screws for valve assembly				
20 (21 mm)	G1/4	2	VABM-B10-20S-G14-2	★ 576417
		4	VABM-B10-20S-G14-4	★ 576419
		6	VABM-B10-20S-G14-6	★ 576421
		8	VABM-B10-20S-G14-8	★ 576423
		10	VABM-B10-20S-G14-10	★ 576425
25 (26,5 mm)	G3/8	2	VABM-B10-25S-G38-2	★ 8026261
		4	VABM-B10-25S-G38-4	★ 8026263
		6	VABM-B10-25S-G38-6	★ 8026265
		8	VABM-B10-25S-G38-8	★ 8026267
		10	VABM-B10-25S-G38-10	★ 8026269
30 (31 mm)	G1/2	2	VABM-B10-30S-G12-2	★ 8026377
		4	VABM-B10-30S-G12-4	★ 8026379
		6	VABM-B10-30S-G12-6	★ 8026381
		8	VABM-B10-30S-G12-8	★ 8026383
		10	VABM-B10-30S-G12-10	★ 8026385
Common supply manifold for mounting on both sides, incl. seals and screws for valve assembly				
20 (21 mm)	G3/8	2	VABM-B10-20-G38-2-P53	★ 576363
		4	VABM-B10-20-G38-4-P53	★ 576365
		6	VABM-B10-20-G38-6-P53	★ 576367
		8	VABM-B10-20-G38-8-P53	★ 576369
		10	VABM-B10-20-G38-10-P53	★ 576371
25 (26,5 mm)	G1/2	2	VABM-B10-25-G12-2-P53	★ 8026219
		4	VABM-B10-25-G12-4-P53	★ 8026221
		6	VABM-B10-25-G12-6-P53	★ 8026223
		8	VABM-B10-25-G12-8-P53	★ 8026225
		10	VABM-B10-25-G12-10-P53	★ 8026227
30 (31 mm)	G3/4	2	VABM-B10-30-G34-2-P53	★ 8026338
		4	VABM-B10-30-G34-4-P53	★ 8026340
		6	VABM-B10-30-G34-6-P53	★ 8026342
		8	VABM-B10-30-G34-8-P53	★ 8026344
		10	VABM-B10-30-G34-10-P53	★ 8026346

19 Plug socket with cable KMF			
Description	Cable length	Type	Part no.
Angled socket, 3-pin, 24 V DC, type B, industry standard			
With LED	2.5 m	KMF-1-24DC-2,5-LED	★ 30935
	5 m	KMF-1-24DC-5-LED	★ 30937

20 Plug socket MSSD		
Description	Type	Part no.
Angled socket, 3-pin, 0 ... 250 V AC/DC, square plug, type C, to EN 175301-803		
Cable connector Pg7	MSSD-EB	★ 151687
Angled socket, 3-pin, 0 ... 250 V AC/DC, square design MSF, type B, industry standard		
Cable connector Pg9	MSSD-F	★ 34431

Cover cap VAMC-B10		
Description	Type	Part no.
For manual override, non-detenting or covered		
Size 20	VAMC-B10-20-CH2-S	★ 8049538
Size 25	VAMC-B10-25-CH2-S	★ 8049539
Size 30	VAMC-B10-25-CH2-S	★ 8049539

Solenoid coil VACS-C for size 20		
Description	Type	Part no.
Connection pattern type C, to EN 175 301		
12 V DC	VACS-C-C1-5	8025331
24 V DC	VACS-C-C1-1	8025330
48 V DC	VACS-C-C1-7	8025336
24 V AC; 50/60 Hz	VACS-C-C1-1A	8025335
48 V AC; 50/60 Hz	VACS-C-C1-7A	8025337
110/120 V AC; 50/60 Hz	VACS-C-C1-16B	8025334
230/240 V AC; 50/60 Hz	VACS-C-C1-3W	8025338

Solenoid coil VACF-B for size 25, 30		
Description	Type	Part no.
Connection pattern type B, industry standard		
12 V DC	VACF-B-B2-5	8030801
24 V DC	VACF-B-B2-1	8030802
48 V DC	VACF-B-B2-7	8030803
24 V AC; 50/60 Hz	VACF-B-B2-1A	8030804
48 V AC; 50/60 Hz	VACF-B-B2-7A	8030805
110/120 V AC; 50/60 Hz	VACF-B-B2-16B	8030806
230/240 V AC; 50/60 Hz	VACF-B-B2-3W	8030808
Connection pattern type C, to EN 175 301		
12 V DC	VACF-B-C1-5	8030810
24 V DC	VACF-B-C1-1	8030811
48 V DC	VACF-B-C1-7	8030812
24 V AC; 50/60 Hz	VACF-B-C1-1A	8030813
48 V AC; 50/60 Hz	VACF-B-C1-7A	8030814
110/120 V AC; 50/60 Hz	VACF-B-C1-16B	8030815
230/240 V AC; 50/60 Hz	VACF-B-C1-3W	8030817

Solenoid coil VACF-B for size 30		
Description	Type	Part no.
Connection pattern type A, to EN 175301-803		
24 V DC	VACF-A-A1-1	8030822

19 Plug socket with cable KMEB			
Description	Cable length	Type	Part no.
Angled socket, 3-pin, 24 V DC, type C, to EN 175301-803			
With LEDs	2.5 m	KMEB-1-24-2,5-LED	★ 151688
	5 m	KMEB-1-24-5-LED	★ 151689

### Designed for reliable and easy operation

The VUVG has been a huge success since it was introduced. This is due in no small part to its first-class pneumatic performance as well as numerous other technical refinements.

Integrated LED for 360° view – convenient for a fast status overview as well as reduced downtimes.

Standard: the non-detenting/detenting manual override for easy commissioning.

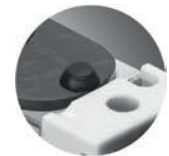

Locating lug for correct mounting of the valve.

Click! Just snap it in and it's done. E-box with numerous connection options for optimum integration into your system concept.

Retained mounting screws: robust, secure mounting, no lost parts.

Imperial connections (inch sizes) can be implemented trouble-free with hybrid fittings.

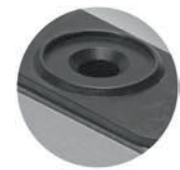

Positive-locking seal integrated into the valve.

Make the most of the available installation space with a host of connection options and functions.

Several pressure zones possible – quickly and easy with separators.



Highly flexible: individual valves can be assembled in series without an additional manifold strip thanks to axial mounting bores.



No additional components required to mount an individual valve onto a valve manifold.

Electrically and pneumatically actuated directional control valves > Universal directional control valves >

## Solenoid valves VUVG ★

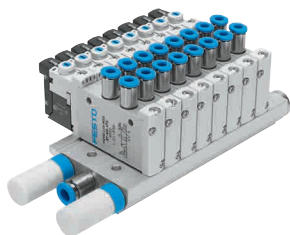

In-line valve VUVG-L10 with seal VABD-L1-10X

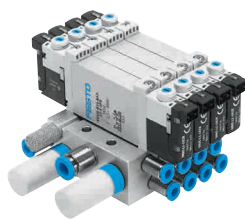

Sub-base valve VUVG-B10

- Connection technology via electrical connection box (E-box)
- Specific I-Port interface from Festo for fieldbus node
- IO-Link® mode for direct connection to a higher-level IO-Link® master
- Festo-specific I-Port interface with interlock
- Variable multi-pin plug connection using Sub-D or flat cable
- Sturdy and durable metal components
- Reversible piston spool valves
- Up to 24 valve positions

### Order code – Basic design

001 002 003 004 005 006 007 008 009 010 011 012 013 014  
**VUVG** - [ ] - [ ] - [ ] - [ ] - [ ] - [ ] - [ ] - [ ] - [ ] - [ ] - [ ] - [ ] - [ ]

<b>001</b>	<b>Type</b>
<b>VUVG</b>	Directional control valve for standard applications
<b>002</b>	<b>Valve type</b>
<b>B</b>	Sub-base valve
<b>L</b>	In-line valve/individual valve
<b>003</b>	<b>Design principle</b>
<b>-</b>	Piston spool with sealing cartridge
<b>K</b>	Piston spool with sealing ring
<b>004</b>	<b>Size</b>
<b>10</b>	Size 10
<b>14</b>	Size 14
<b>18</b>	Size 18
<b>005</b>	<b>Valve function</b>
<b>B52</b>	5/2-way valve, double solenoid
<b>M52</b>	5/2-way valve, single solenoid
<b>P53C</b>	5/3-way valve, mid-position closed
<b>T32C</b>	2x 3/2-way valve, single solenoid, normally closed
<b>006</b>	<b>Reset method</b>
<b>-</b>	None, for valve function B52 and P53
<b>A</b>	Pneumatic spring, for valve function T32 and M52
<b>M</b>	Mechanical spring, for valve function M52
<b>R</b>	Pneumatic/mechanical spring, for valve function M52
<b>007</b>	<b>Pilot air supply</b>
<b>-</b>	Internal

<b>008</b>	<b>Manual override</b>
<b>T</b>	Non-detenting, detenting
<b>009</b>	<b>Pneumatic connection</b>
<b>M5</b>	Thread M5
<b>M7</b>	Thread M7
<b>G18</b>	Thread G1/8
<b>G14</b>	Thread G1/4
<b>F</b>	Flange/sub-base
<b>010</b>	<b>Exhaust</b>
<b>-</b>	Without fitting
<b>011</b>	<b>Nominal operating voltage</b>
<b>1</b>	24 V DC
<b>012</b>	<b>Electrical connection</b>
<b>R8</b>	Individual plug M8, 3-pin
<b>H2</b>	Connection pattern H, horizontal plug
<b>013</b>	<b>Signal status display</b>
<b>L</b>	LED (integrated)
<b>014</b>	<b>Version</b>
<b>-</b>	Extended features
<b>S</b>	Core features

**Legend:** [ ] Mandatory entry [ ] Optional entry

### Product options

Type of directional control valve:

S Semi in-line valve

Valve functions:

M32C 3/2-way valve, single solenoid, closed

M32U 3/2-way valve, single solenoid, open

P53U 5/3-way valve, pressurised

P53E 5/3-way valve, exhausted

T32... 2x 3/2-way valve

Pilot air supply:

Z External

Manual override:

S Covered

H Non-detenting

Pneumatic connection:

Push-in connector 6 ... 10 mm

Push-in connector 5/32" ... 3/8"

Exhausting:

U Silencer

QN With fitting

Nominal operating voltage:

5 V DC, 12 V DC

Electrical connection

T1 Plug-in

H... Connection pattern H

S... Connection pattern S

L... With flying leads

K... With cable

R... Individual plugs

P3 Without electrical connection box

## Ordering – Product options



Configurable product

This product and all its product options can be ordered online via the configurator:

→ [www.festo.com/catalogue/vuvg](http://www.festo.com/catalogue/vuvg)

## Ordering – Basic design

014 Core features						
004 Size	Type	Part no.	Type	Part no.	Type	Part no.
012 Electrical connection box R8 with individual plug M8, 002 In-line valve/individual valve, 003 Piston spool with sealing ring						
	005 2x3/2-way, normally closed		005 5/2-way, single solenoid		005 5/2-way, double solenoid	
	006 Pneumatic spring		006 Pneumatic spring		006 –	
Size 10	VUVG-LK10-T32C-AT-M5-1R8L-S	★ 8042542	VUVG-LK10-M52-AT-M5-1R8L-S	★ 8042543	VUVG-LK10-B52-T-M5-1R8L-S	★ 8042544
	VUVG-LK10-T32C-AT-M7-1R8L-S	★ 8042550	VUVG-LK10-M52-AT-M7-1R8L-S	★ 8042551	VUVG-LK10-B52-T-M7-1R8L-S	★ 8042552
Size 14	VUVG-LK14-T32C-AT-G18-1R8L-S	★ 8042566	VUVG-LK14-M52-AT-G18-1R8L-S	★ 8042567	VUVG-LK14-B52-T-G18-1R8L-S	★ 8042568
012 Electrical connection box H2 with horizontal plug, 002 In-line valve/individual valve, 003 Piston spool with sealing ring						
	005 2x3/2-way, normally closed		005 5/2-way, single solenoid		005 5/2-way, double solenoid	
	006 Pneumatic spring		006 Pneumatic spring		006 –	
Size 10	VUVG-LK10-T32C-AT-M5-1H2L-S	★ 8042538	VUVG-LK10-M52-AT-M5-1H2L-S	★ 8042539	VUVG-LK10-B52-T-M5-1H2L-S	★ 8042540
	VUVG-LK10-T32C-AT-M7-1H2L-S	★ 8042546	VUVG-LK10-M52-AT-M7-1H2L-S	★ 8042547	VUVG-LK10-B52-T-M7-1H2L-S	★ 8042548
Size 14	VUVG-LK14-T32C-AT-G18-1H2L-S	★ 8042562	VUVG-LK14-M52-AT-G18-1H2L-S	★ 8042563	VUVG-LK14-B52-T-G18-1H2L-S	★ 8042564
012 Electrical connection box R8 with individual plug M8, 002 Sub-base valve, 003 Piston spool with sealing ring						
	005 2x3/2-way, normally closed		005 5/2-way, single solenoid		005 5/2-way, double solenoid	
	006 Pneumatic spring		006 Pneumatic spring		006 –	
Size 10	VUVG-BK10-T32C-AT-F-1R8L-S	★ 8042558	VUVG-BK10-M52-AT-F-1R8L-S	★ 8042559	VUVG-BK10-B52-T-F-1R8L-S	★ 8042560
Size 14	VUVG-BK14-T32C-AT-F-1R8L-S	★ 8042574	VUVG-BK14-M52-AT-F-1R8L-S	★ 8042575	VUVG-BK14-B52-T-F-1R8L-S	★ 8042576
012 Electrical connection box H2 with horizontal plug, 002 Sub-base valve, 003 Piston spool with sealing ring						
	005 2x3/2-way, normally closed		005 5/2-way, single solenoid		005 5/2-way, double solenoid	
	006 Pneumatic spring		006 Pneumatic spring		006 –	
Size 10	VUVG-BK10-T32C-AT-F-1H2L-S	★ 8042554	VUVG-BK10-M52-AT-F-1H2L-S	★ 8042555	VUVG-BK10-B52-T-F-1H2L-S	★ 8042556
Size 14	VUVG-BK14-T32C-AT-F-1H2L-S	★ 8042570	VUVG-BK14-M52-AT-F-1H2L-S	★ 8042571	VUVG-BK14-B52-T-F-1H2L-S	★ 8042572

014 Extended features						
004 Size	Type	Part no.	Type	Part no.	Type	Part no.
012 Electrical connection box R8 with individual plug M8, 002 In-line valve/individual valve, 003 Piston spool with sealing cartridge						
	005 2x3/2-way, normally closed		005 5/2-way, single solenoid			
	006 Pneumatic spring		006 Pneumatic/mechanical spring			
Size 18	VUVG-L18-T32C-AT-G14-1R8L	★ 8031525	VUVG-L18-M52-RT-G14-1R8L	★ 8031531		
			VUVG-L18-M52-MT-G14-1R8L <sup>1)</sup>	★ 8031532		
	005 5/3-way, mid-position closed					
	006 –					
Size 10	VUVG-L10-P53C-T-M5-1R8L	★ 577346				
	VUVG-L10-P53C-T-M7-1R8L	★ 574223				
Size 14	VUVG-L14-P53C-T-G18-1R8L	★ 574231				
Size 18	VUVG-L18-P53C-T-G14-1R8L	★ 8031534				

1) 006 Mechanical spring

Electrically and pneumatically actuated directional control valves > Universal directional control valves >

Solenoid valves VUVG ★

Accessories

In-line valve VUVG-L with seal

Sub-base valve VUVG-B

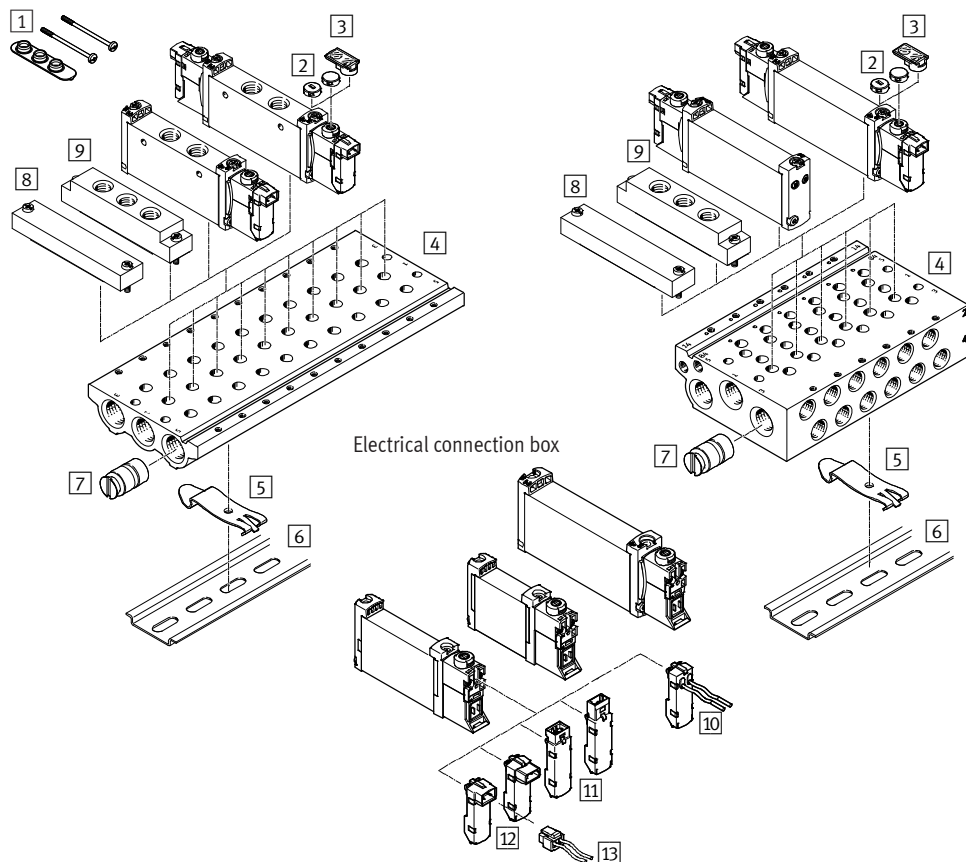

- 1 Seal VABD-L1-10X for in-line valve → 100
  - 2 Cover VMPA-HBT-B for manual override, non-detenting → 100
  - 3 Inscription label holder ASLR-D for labelling the valves, covering the retaining screw and the manual override → 100
  - 4 Manifold rail VABM for 2 to 10 valve positions → 101
  - 5 H-rail mounting VAME-T-M4 for fitting the valve manifold on an H-rail → 100
  - 6 H-rail NRH-35-2000 for mounting → nrh-35
  - 7 Separator VABD-B for creating pressure zones → 101
  - 8 Blanking plate VABB for covering an unused valve position → 101
  - 9 Supply plate VABF → 101
- Electrical connection box VAVE
- 10 With flying leads → 101
  - 11 With vertical plug → 101
  - 12 With horizontal plug → 101
  - 13 Plug socket with cable NEBV, open end → 101

Size	Pneum. connection	Type	Part no.
For VUVG-L			
002 In-line valve/individual valve, 003 Piston spool with sealing cartridge			
10	M5	VABD-L1-10X-S-M5	★ 566672
10	M7	VABD-L1-10X-S-M7	★ 566673
14	G1/8	VABD-L1-14X-S-G18	★ 566675
18	G1/4	VABD-L1-18X-S-G14	★ 574479
18	G1/4	VABD-L1-18B-S-G14	574480
For VUVG-LK			
002 In-line valve/individual valve, 003 Piston spool with sealing ring			
10	M5	VABD-L1-10XK-S-M5	★ 8043718
10	M7	VABD-L1-10XK-S-M7	★ 8043719
14	G1/8	VABD-L1-14XK-S-G18	★ 8043720

Size	Type	Part no.
10, 14, 18	VMPA-HBT-B (10 Stück)	540897
3 Inscription label holder ASLR		
Size	Type	Part no.
10, 14, 18	ASLR-D-L1 (10 Stück)	570818
5 H-rail mounting VAME		
Size	Type	Part no.
10, 14 18	VAME-T-M4 (2 Stück)	★ 569998

## Accessories

4 Manifold rail VABM						
Size	Connection <sup>1)</sup>	Valve positions	Type	Part no.		
For individual valve VUVG-L with seal VABD-L1-10X [1]						
10	M5/M7	2	VABM-L1-10S-G18-2	★ 566558		
		3	VABM-L1-10S-G18-3	★ 566559		
		4	VABM-L1-10S-G18-4	★ 566560		
		6	VABM-L1-10S-G18-6	★ 566562		
		8	VABM-L1-10S-G18-8	★ 566564		
10	M5/M7	10	VABM-L1-10S-G18-10	★ 566566		
		14	G1/4	2	VABM-L1-14S-G14-2	★ 566618
				3	VABM-L1-14S-G14-3	★ 566619
				4	VABM-L1-14S-G14-4	★ 566620
				6	VABM-L1-14S-G14-6	★ 566622
8	VABM-L1-14S-G14-8			★ 566624		
10	M5/M7	10	VABM-L1-14S-G14-10	★ 566626		
		18	G3/8	2	VABM-L1-18S-G38-2	★ 574455
				3	VABM-L1-18S-G38-3	★ 574456
4	VABM-L1-18S-G38-4			★ 574457		
6	VABM-L1-18S-G38-6			★ 574459		
8	VABM-L1-18S-G38-8			★ 574461		
10	M5	10	VABM-L1-18S-G38-10	★ 574463		
		For sub-base valve VUVG-B				
10	M5	2	VABM-L1-10W-G18-2	★ 566582		
		3	VABM-L1-10W-G18-3	★ 566583		
		4	VABM-L1-10W-G18-4	★ 566584		
		6	VABM-L1-10W-G18-6	★ 566586		
		8	VABM-L1-10W-G18-8	★ 566588		
	M7	10	VABM-L1-10W-G18-10	★ 566590		
		2	VABM-L1-10HW-G18-2	★ 566606		
		3	VABM-L1-10HW-G18-3	★ 566607		
		4	VABM-L1-10HW-G18-4	★ 566608		
		6	VABM-L1-10HW-G18-6	★ 566610		
14	G1/8	8	VABM-L1-10HW-G18-8	★ 566612		
		10	VABM-L1-10HW-G18-10	★ 566614		
		2	VABM-L1-14W-G18-2	★ 566642		
		3	VABM-L1-14W-G18-3	★ 566643		
14	G1/8	4	VABM-L1-14W-G18-4	★ 566644		
		6	VABM-L1-14W-G18-6	★ 566646		
		8	VABM-L1-14W-G18-8	★ 566648		
		10	VABM-L1-14W-G18-10	★ 566650		
		18	G3/8	2	VABM-L1-18W-G38-2	574467
3	VABM-L1-18W-G38-3			574468		
4	VABM-L1-18W-G38-4			574469		
6	VABM-L1-18W-G38-6			574471		
8	VABM-L1-18W-G38-8			574473		
10	VABM-L1-18W-G38-10			574475		

1) VABM-L1-...S: Supply ports 1, 3, 5  
VABM-L1-...W, VABM-L1-...HW: working ports 2, 4

7 Separator VABD-B		
Size	Type	Part no.
For manifold rail VABM-L1-S, for individual valve VUVG-L		
10	VABD-8-B	569995
14	VABD-10-B	569996
For manifold rail VABM-L1-W, for sub-base valve VUVG-B		
10	VABD-6-B	569994
14	VABD-10-B	569996

8 Blanking plate VABB			
Size	Type	Part no.	
For manifold rail VABM-L1-S, for individual valve VUVG-L			
10	VABB-L1-10-S	★	566462
14	VABB-L1-14	★	569989
18	VABB-L1-18	★	574482
For manifold rail VABM-L1-W, for sub-base valve VUVG-B			
10	VABB-L1-10-W	★	566495
14	VABB-L1-14	★	569989
18	VABB-L1-18	★	574482

9 Supply plate VABF			
Size	Connection	Type	Part no.
For manifold rail VABM-L1-S, for individual valve VUVG-L			
10	M5	VABF-L1-10-P3A4-M5	569991
10	M7	VABF-L1-10-P3A4-M7	569992
14	G1/8	VABF-L1-14-P3A4-G18	569993
18	G1/4	VABF-L1-18-P3A4-G14	574481
For manifold rail VABM-L1-W, for sub-base valve VUVG-B			
10	M5	VABF-L1-10-P3A4-M5	569991
10	M7	VABF-L1-10-P3A4-M7	569992
14	G1/8	VABF-L1-14-P3A4-G18	569993
18	G1/4	VABF-L1-18-P3A4-G14	574481

10/11/12 Electrical connection box VAVE		
Description	Type	Part no.
10 With flying leads, LED, protective circuit		
0.5 m, 24 and 12 V DC	VAVE-L1-1VL1-LP <sup>1)</sup>	566722
1 m	VAVE-L1-1VL2-LP <sup>1)</sup>	566723
2.5 m	VAVE-L1-1VL3-LP <sup>1)</sup>	566724
1 m	VAVE-L1-1VK7-LP <sup>3)</sup>	★ 573942
11 Vertical plug, LED, protective circuit		
24 and 12 V DC	VAVE-L1-1VH3-LP <sup>1)</sup>	566715
12 Horizontal plug, LED, protective circuit		
24 and 12 V DC	VAVE-L1-1VH2-LP <sup>1)</sup>	★ 566714
24 V DC	VAVE-L1-1H2-LR <sup>2)</sup>	★ 566716
24 and 12 V DC	VAVE-L1-1VR8-LP <sup>3)</sup>	★ 573919

1) Additional functions: spark arresting, bipolar, IP40  
2) Additional functions: spark arresting, reduction of holding current, IP40  
3) Additional functions: spark arresting, bipolar, IP65

13 Plug socket with cable NEBV			
Description	Cable length	Type	Part no.
Straight socket, 2-pin			
Flying leads, open end	0.5 m	NEBV-H1G2-KN-0.5-LE	★ 566654
	1 m	NEBV-H1G2-KN-1-LE2	★ 566655
	2.5 m	NEBV-H1G2-KN-2.5-LE	★ 566656
Individual cable, 0.5 m, open end, 2-pin	0.5 m	NEBV-H1G2-P-0.5-LE2	★ 566658
	1 m	NEBV-H1G2-P-1-LE2	★ 566659
	2.5 m	NEBV-H1G2-P-2.5-LE2	★ 566660

Electrically and pneumatically actuated directional control valves > Standards-based directional control valves >

## Solenoid valves VSNC, to NAMUR ★

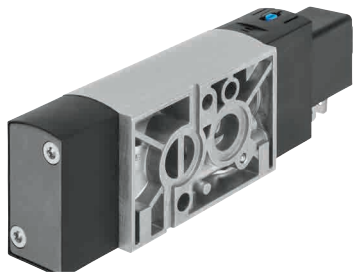

- Connection G1/4
  - Flow rate 1250 l/min
  - Voltage 12, 24, 48 V DC, 24, 48, 120, 230 V AC
  - Namur connection pattern to VDE/VDI 3845
  - Solenoid actuated, piloted
  - Mechanical spring return
  - Can be converted from 5/2- to 3/2-way function
  - Selected types in accordance with ATEX directive for potentially explosive atmospheres
- [www.festo.com/ex](http://www.festo.com/ex)

### Order code – Basic design

001 002 003 004 005 006 007 008 009 010 011 012  
**VSNC** - **F** - **C** - **M52** - **M** **D** - **G14** - - - - - - - - - - - - - - - -

001	Type
VSNC	Solenoid valve
002	Valve type
F	Flanged valve
003	Design principle
-	Piston spool
004	Additional function
C	Convertible valve function
005	Valve function
M52	5/2-way valve, single solenoid
006	Reset method for single solenoid valves
M	Mechanical spring
007	Manual override
D	Non-detenting, detenting

008	Pneumatic connection
G14	G1/4
009	Exhaust
-	Without fitting
010	Interface to valve controller
F8	With armature tube 8 mm long
FN	With armature tube 9 mm long
011	Nominal operating voltage
-	Without
1	24V DC
012	Electrical connection
-	Without
B2	Connecting cable type B, industry standard

Legend:  Mandatory entry  Optional entry

### Product options

T	Poppet valve	Pneumatic connection	N14 1/4NPT	Ignition protection type	Degree of protection for electrics
M32C	3/2-way valve, normally closed	Exhaust	QN With fitting	A Intrinsically safe	S8 IP67
B52	5/2-way valve, double solenoid	U Silencer	U Silencer	M Encapsulation	EU certification
P53C	5/3-way valve, mid-position closed	Pneumatic connection	Push-in connector 6 ... 10 mm	N Non-sparking	EX2 II 3GD
P53E	5/3-way valve, mid-position exhausted	Push-in connector 1/4 ... 3/8	Push-in connector 1/4 ... 3/8	Electrical connection	EX4 II 2GD
P53U	5/3-way valve, mid-position pressurised	Nominal operating voltage	12 V DC, 24 V AC/50-60 Hz,	A1 Connecting cable type A, to EN 175301	Certification
H	Manual override, non-detenting, resetting	48 V AC/50-60 Hz,	110 V AC/50-60 Hz, 230 V AC/50-60	C3 Cable, 3 m	U4 Class 1 Div 1 to NEC 500
S	Manual override, covered	Hz		K11 Cable with insulating conduit connection	

### Ordering – Product options

Configurable product

This product and all its product options can be ordered online via the configurator:

→ [www.festo.com/catalogue/vsnc](http://www.festo.com/catalogue/vsnc)



## Ordering – Basic design

Without solenoid coil, convertible valve function			
008 Pneumatic connection	Type	Part no.	
012 Without electrical connection			
005 5/2-way valve, single solenoid			
010 With armature tube 8 mm long			
G1/4	VSNC-FC-M52-MD-G14-F8	★	577257
010 With armature tube 9 mm long			
G1/4	VSNC-FC-M52-MD-G14-FN	★	577267

With 24 V DC solenoid coil, without plug socket, convertible valve function			
008 Pneumatic connection	Type	Part no.	
012 Electrical connection			
005 5/2-way valve, single solenoid			
010 With armature tube 8 mm long			
G1/4	VSNC-FC-M52-MD-G14-F8-1B2	★	577295
Connection pattern type B, industry standard			

## Accessories

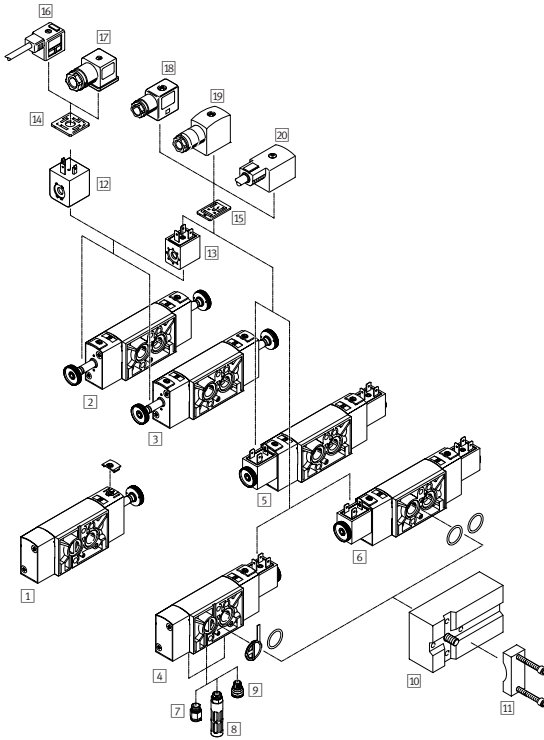

### Solenoid valves VSNC...-F8

- 1 3/2-way and 5/2-way valve, single solenoid → 103
- 2 5/2-way valve, double solenoid → vsnc
- 3 5/3-way valve, single solenoid, normally open, closed or exhausted → vsnc
- 4 3/2-way and 5/2-way valve, single solenoid, with solenoid coil → 103
- 5 5/2-way valve, double solenoid, with solenoid coil → 103
- 6 5/3-way valve, single solenoid, normally open, closed or exhausted, with solenoid coil → 103
- 7 Push-in fitting QS → 168
- 8 Silencer U → 192
- 9 Exhaust protection VABD-D3-SN-G14 → vsnc
- 10 Connection kit VABS-S7-S-G14 → vsnc
- 11 Mounting bracket VAME-S7-Y → vsnc
- 12 Solenoid coil VACF-A, VACF-N → 103
- 13 Solenoid coil VACF-B → 103
- 14 Illuminating seal MC-LD → vsnc
- 15 Illuminating seal MF-LD → vsnc
- 16 Connecting cable KMC → vsnc
- 17 Plug socket MSSD-C → vsnc
- 18 Plug socket MSSD-F → vsnc
- 19 Plug socket MSSD-F-S → vsnc
- 20 Connecting cable KMF → kmf

### 12/13 Solenoid coil VACF for F8 armature tube (8 mm)

Description	Type	Part no.
Connection pattern to industry standard, type B		
	12 V DC; 3,4 W	VACF-B-B2-5 8030801
	24 V DC; 3,3 W	VACF-B-B2-1 8030802
	48 V DC; 3,4 W	VACF-B-B2-7 8030803
	24 V AC; 50/60 Hz	VACF-B-B2-1A 8030804
	48 V AC; 50/60 Hz	VACF-B-B2-7A 8030805
	110/120 V AC; 50/60 Hz	VACF-B-B2-16B 8030806
	230/240 V AC; 50/60 Hz	VACF-B-B2-3W 8030808

Description	Type	Part no.
Connection pattern to DIN EN 175301-803, type A		
	12 V DC; 2,8 W	VACF-A-A1-5 8030821
	24 V DC; 2,6 W	VACF-A-A1-1 ★ 8030822
	48 V DC; 2,8 W	VACF-A-A1-7 8030823
	24 V AC; 50/60 Hz	VACF-A-A1-1A 8030824
	48 V AC; 50/60 Hz	VACF-A-A1-7A 8030825
	110/120 V AC; 50/60 Hz	VACF-A-A1-16B 8030826
	230/240 V AC; 50/60 Hz	VACF-A-A1-3W 8030828

### Solenoid coil VACN-N for FN armature tube (9 mm)

Description	Type	Part no.
Type of ignition protection: intrinsically safe Ex ia		
	28 V	VACN-N-A1-1-EX4-A 8029139
Type of ignition protection: non-sparking Ex nA		
	24 V DC; 2,1 W	VACN-N-A1-1-EX2-N 8029136
	110 V AC; 50/60 Hz	VACN-N-A1-16B-EX2-N 8029137
	230 V AC; 50/60 Hz	VACN-N-A1-3A-EX2-N 8029138
Degree of protection IP65 with socket		
	24 V DC; 0,7 W	VACN-N-A1-1 ★ 8029144
	110 V AC; 50/60 Hz	VACN-N-A1-16B 8029134
	230 V AC; 50/60 Hz	VACN-N-A1-3A 8029135

Description	Type	Part no.
Type of ignition protection: encapsulated Ex me		
	230 V AC; 50/60 Hz	VACN-N-K11-3A-EX4-M 8029141
	110 V AC; 50/60 Hz	VACN-N-K11-16B-EX4-M 8029142
	24 V DC; 2,6 W	VACN-N-K11-1-EX4-M 8029143
Type of ignition protection: encapsulated AEx m, Class 1, Div 1 to NEC 500		
	230 V AC; 50 Hz	VACN-N-K11-3A-0.5-U4-M 8029140
	120 V AC; 60 Hz	VACN-N-K11-16B-0.5-U4-M 8029145
	24 V DC; 4,6 W	VACN-N-K11-1-0.5-U4-M 8029146

Electrically and pneumatically actuated directional control valves > Standards-based directional control valves >

Solenoid valve VSVA, to ISO 5599-1 ★

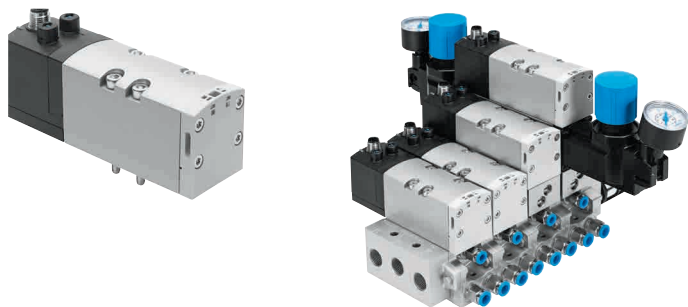

- Sturdy metal design
- Width 42 mm/ISO size 1
- Flow rate up to 1300 l/min
- Solenoid coil with central plug M12, 24 V DC
- Wide range of vertical stacking modules: pressure regulator, flow control, vertical pressure shut-off plate, etc.
- Also available as a valve manifold

Order code

001 002 003 004 005 006 007 008 009 010  
**VSVA** - **B** - [ ] - [ ] - [ ] - **D1** - **1** **R5** **L**

Legend:  Mandatory entry  Optional entry

001	Type
VSVA	Standards-based valves to ISO 5599-1
002	Valve type
B	Sub-base valve
003	Valve function
M52	5/2-way valve, single solenoid
B52	5/2-way valve, double solenoid
004	Reset method
-	Without, for valve function B52
A	Pneumatic spring, for valve function M52
M	Mechanical spring, for valve function M52
005	Pilot air supply
-	Internal

006	Manual override
D	Non-detenting, detenting
H	Non-detenting
007	Pneumatic connection (width)
D1	Width 42 mm/ISO size 1
008	Nominal operating voltage
1	24 VDC
009	Electrical connection
R5	Central plug M12x1
010	Signal status display
L	LED (integrated)

Product options

D52	5/2-way valve, double solenoid with dominant signal at 14	T32U	2x 3/2-way valve, normally open	T32N	2x 3/2-way valve, normally open, reverse operation	Additional function V 2x 2/2-way valve with vacuum operation Z External pilot air supply D2 Pneumatic connection: width 52 mm/ISO size 2
P53C	5/3-way valve, mid-position closed	T32H	2x 3/2-way valve, normally 1x open, 1x closed	T32W	2x 3/2-way valve, normally 1x open, 1x closed, reverse operation	
P53E	5/3-way valve, mid-position exhausted	T32F	2x 3/2-way valve, normally open, reverse operation	T22C	2x 2/2-way valve, normally closed	
P53U	5/3-way valve, mid-position pressurised					
T32C	2x 3/2-way valve, normally closed					

Configurable product

This product and all its product options can be ordered online via the configurator:

→ [www.festo.com/catalogue/vsva](http://www.festo.com/catalogue/vsva)

## Ordering – Basic design

003 Valve function	004 Reset method	007 Pneumatic connection (width)	Type	Part no.
5/2-way valve, single solenoid	Reset method: pneumatic spring	Width 42 mm/ISO size 1	<b>VSVA-B-M52-AD-D1-1R5L</b>	★ 561362
5/2-way valve, single solenoid	Reset method: mechanical spring		<b>VSVA-B-M52-MD-D1-1R5L</b>	★ 561363
5/2-way valve, double pilot	Without, dominance: 1st signal		<b>VSVA-B-B52-D-D1-1R5L</b>	★ 561364

## Accessories

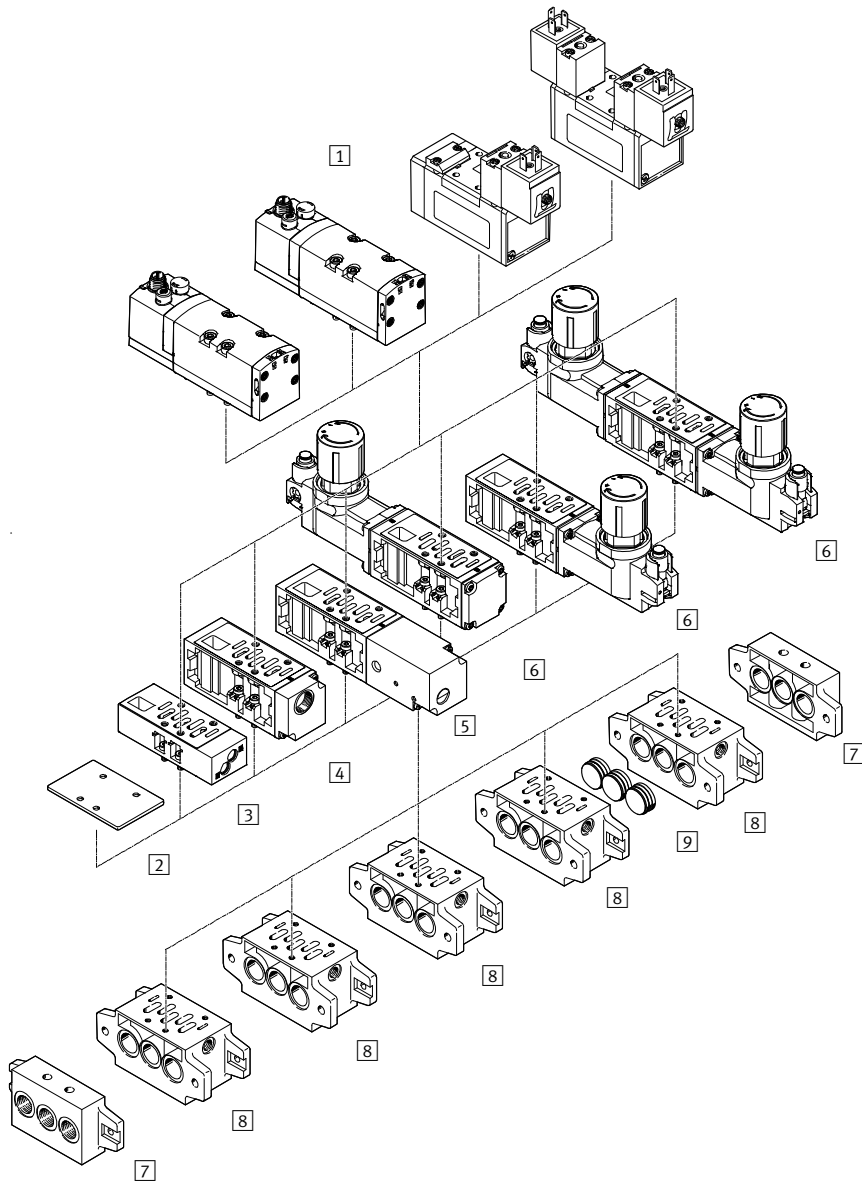

### Manifold assembly

- 1 Solenoid valve VSVA with central plug M12, 3-pin  
Individual sub-base NAS, NAU → 105
- 2 Blanking plate NDV → 105
- 3 Flow control plate  
VABF-S1-...-F1B1-C, GRO-ZP-... → vsva
- 4 Vertical pressure supply plate  
VABF-S1-...-P1A3-G38 → vsva
- 5 Vertical pressure shut-off plate  
VABF-S1-...-L1D1-C → vsva
- 6 Regulator plate VABF-S1-...-R..., LR-ZP-... → vsva
- 7 End plate kit NEV → 105
- 8 Manifold sub-base NAV → 105
- 9 Isolating disc NSC → 105

Manifold sub-base with 90° connections NAVW → 105

1 Individual sub-base NAS, NAU		
For	Type	Part no.
Lateral pneumatic connections		
42 mm	<b>NAS-1/4-1A-ISO</b>	★ 9484
Pneumatic connections underneath		
42 mm	<b>NAU-1/4-1B-ISO</b>	★ 9485

2 Blanking plate NDV		
For	Type	Part no.
42 mm	<b>NDV-1-ISO</b>	★ 9489

7 End plate kit NEV		
For	Type	Part no.
42 mm	<b>NEV-1DA/DB-ISO</b>	★ 10174

8 Manifold sub-base NAV		
For	Type	Part no.
Connections underneath		
42 mm	<b>NAV-1/4-1C-ISO</b>	★ 10173

9 Isolating disc NSC		
For	Type	Part no.
42 mm	<b>NSC-1/4-1-ISO</b>	★ 11550

Manifold sub-base with 90° connections NAVW		
For	Type	Part no.
Connections on the side and underneath		
42 mm	<b>NAVW-1/4-1-ISO</b>	★ 152789

Electrically and pneumatically actuated directional control valves > Standards-based directional control valves >

## Solenoid valve VSVA, to ISO 15407-1 ★

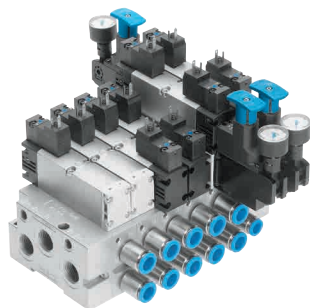

- High-performance valves in a sturdy metal housing
- Width of standards-based valve 18/26 mm, flow rates up to 1400 l/min
- Manifold assembly with mixture of sizes possible
- Electrical connection via round or square plug socket
- Complete and standardised valve range
- Wide range of vertical stacking modules: pressure regulator, flow control valve, vertical pressure shut-off plate, etc.

### Order code

001 002 003 004 005 006 007 008 009 010 011

VSVA - B - [ ] - [ ] - H - [ ] - 1 - [ ] - [ ]

Legend:  Mandatory entry  Optional entry

001	Type
VSVA	Standards-based valves, to ISO 15407-1
002	Valve type
B	Sub-base valve
003	Valve function
M52	5/2-way valve, single solenoid
B52	5/2-way valve, double solenoid
P53E	5/3-way valve, mid-position exhausted
004	Reset method
-	Without, double solenoid valve
A	Pneumatic spring
M	Mechanical spring
005	Pilot air supply
-	Internal
006	Manual override
H	With manual override

007	Pneumatic connection (width)
A1	ISO size 01, width 26 mm
A2	ISO size 02, width 18 mm
008	Nominal operating voltage
1	24 V DC
009	Electrical connection
C1	Type C to EN 175301-803
R5	Central plug M12x1
010	Signal status display
-	Without
L	LED (integrated)
011	Position sensing
-	Without sensor

### Product options

D52	5/2-way valve, double solenoid with dominant signal at 14	T32F	2x 3/2-way valve, normally open, reverse operation	Operating voltage 24 V AC, 110 V AC, 230 V AC, 12 V DC	Position sensing APC Proximity sensor PNP with open cable end APP Proximity sensor PNP with plug M8 ANC Proximity sensor NPN with open cable end ANP Proximity sensor NPN with plug M8
P53C	5/3-way valve, mid-position closed	T32N	2x 3/2-way valve, normally open, reverse operation		
P53U	5/3-way valve, mid-position pressurised	T32W	2x 3/2-way valve, normally 1x open, 1x closed, reverse operation	Electrical connection R2 Central plug M8x1 R3 Individual plug M12 P1 Without pilot valve	
T32C	2x 3/2-way valve, normally closed	T22C	2x 2/2-way valve, normally closed		
T32U	2x 3/2-way valve, normally open	Z	External pilot air supply		
T32H	2x 3/2-way valve, normally 1x open, 1x closed				



Configurable product

This product and all its product options can be ordered online via the configurator:

→ [www.festo.com/catalogue/vsva](http://www.festo.com/catalogue/vsva)

## Ordering – Basic design

003 Valve function	007 Pneumatic connection A1 Port pattern to ISO size 26 mm (01)		007 Pneumatic connection A2 Port pattern to ISO size 18 mm (02)	
	Type	Part no.	Type	Part no.
<b>009 Electrical connection R5: with central plug M12x1</b>				
5/2-way valve, single solenoid	VSVA-B-M52-AH-A1-1R5L	★ 534555	VSVA-B-M52-AH-A2-1R5L	★ 546767
	VSVA-B-M52-MH-A1-1R5L	★ 534556	VSVA-B-M52-MH-A2-1R5L	★ 546768
5/2-way valve, double pilot	VSVA-B-B52-H-A1-1R5L	★ 534557	VSVA-B-B52-H-A2-1R5L	★ 546769
5/3-way valve, mid-position exhausted	VSVA-B-P53E-H-A1-1R5L	★ 534560		
<b>009 Electrical connection C1: type C to EN 175301-803 (with pilot control with square plug type C to EN 175301-803)</b>				
5/2-way valve, single solenoid	VSVA-B-M52-AH-A1-1C1	★ 546700	VSVA-B-M52-AH-A2-1C1	★ 546701
	VSVA-B-M52-MH-A1-1C1	★ 546702	VSVA-B-M52-MH-A2-1C1	★ 546703
5/2-way valve, double pilot	VSVA-B-B52-H-A1-1C1	★ 546696	VSVA-B-B52-H-A2-1C1	★ 546697
5/3-way valve, mid-position exhausted	VSVA-B-P53E-H-A1-1C1	★ 546706		

## Accessories

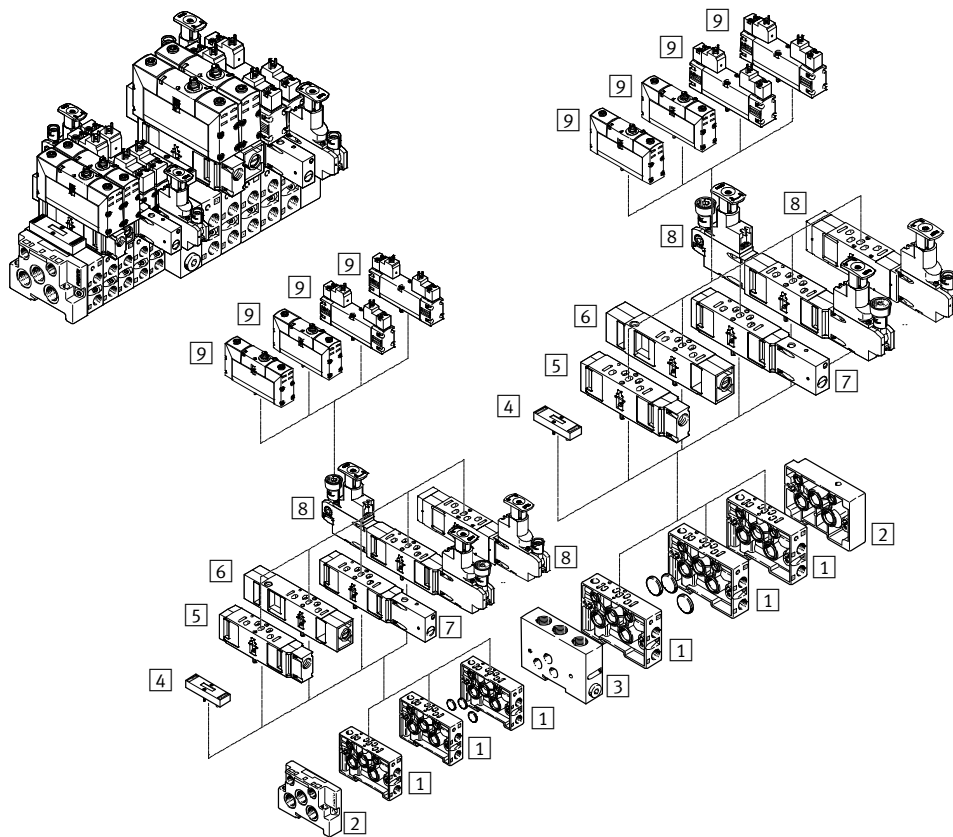

- 1 Manifold sub-base NAW with lateral ports 2 and 4 → 107
- 2 End plate kit NEV for sealing the manifold sub-bases → 107
- 3 Intermediate plate NZV for connecting width 18 mm with width 26 mm → vsva
- 4 Blanking plate NDV for vacant or spare positions → vsva
- 5 Vertical supply plate VABF...P1-A3 for intermediate air supply → vsva
- 6 Flow control plate VABF...F1-B1 for flow control in ducts 3 and 5 → vsva
- 7 Vertical pressure shut-off plate VABF...L1-D1 with switch for manual shut-off of duct 1 → vsva
- 8 Regulator plate VABF...R...-C2 → vsva
- 9 Solenoid valve VSVA → 106

Individual sub-base NAS → 107

1 Manifold sub-base NAW with lateral ports 2 and 4		
For	Type	Part no.
26 mm	NAW-1/4-01-VDMA	★ 161102
18 mm	NAW-1/8-02-VDMA	★ 161110

4 Blanking plate NDV		
For	Type	Part no.
26 mm	NDV-01-VDMA	★ 161107
18 mm	NDV-02-VDMA	★ 161114

Individual sub-base NAS		
For	Type	Part no.
26 mm	NAS-1/4-01-VDMA	★ 161109
18 mm	NAS-1/8-02-VDMA	★ 161115

2 End plate kit NEV		
For	Type	Part no.
26 mm	NEV-01-VDMA	★ 161104
18 mm	NEV-02-VDMA	★ 161112

Shut-off valves > Check valves and quick exhaust valves >

## Check valves, piloted HGL ★

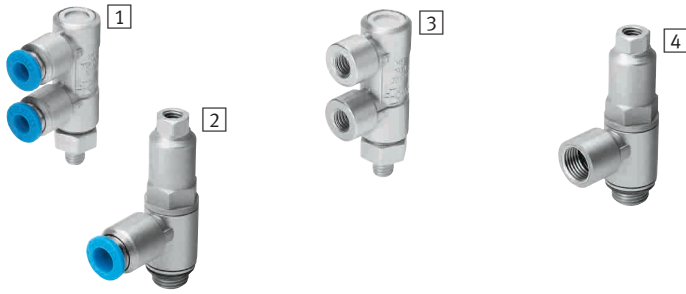

- Controlled, piloted non-return function
- Manual exhausting
- Rotatable when installed
- Push-in connector  
Flow rate 130 ... 1400 l/min
- Female thread  
Flow rate 130 ... 1600 l/min

- 1 HGL-M5-QS-4
- 2 HGL-...-QS
- 3 HGL-M5-B
- 4 HGL-...-B

## Order code

001 002 003 004  
HGL -   -    

Legend:   Mandatory entry   Optional entry

001	Type
HGL	Check valve, piloted, non-return function

002	Pneumatic connection 2
M5	Male thread M5
1/8	Male thread G1/8
1/4	Male thread G1/4
3/8	Male thread G3/8
1/2	Male thread G1/2

003	Pneumatic connection 1
-	Connection size as for connection 2, female thread
QS-4	Push-in connector for tubing O.D. 4 mm
QS-6	Push-in connector for tubing O.D. 6 mm
QS-8	Push-in connector for tubing O.D. 8 mm
QS-10	Push-in connector for tubing O.D. 10 mm
QS-12	Push-in connector for tubing O.D. 12 mm

004	Generation
-	Without
B	Optimised function

## Ordering

	002 Pneumatic connection 2	003 Pneumatic connection 1	Pilot air connection 21	Standard nominal flow rate qnN in flow direction at 6 bar 5 bar [l/min]	Standard flow rate qn in flow direction at 6 bar 0 bar [l/min]	Type	Part no.
<b>Push-in/threaded connection</b>							
<span style="border: 1px solid black; padding: 0 2px;">1</span>	M5	QS-4	QS-4	130	200	HGL-M5-QS-4	★ 530038
<span style="border: 1px solid black; padding: 0 2px;">2</span>	G1/8	QS-4	M5	200	300	HGL-1/8-QS-6	★ 530039
	G1/8	QS-6	M5	270	400	HGL-1/8-QS-6	★ 530040
	G1/4	QS-8	G1/8	390	640	HGL-1/4-QS-8	★ 530041
	G1/4	QS-10	G1/8	400	670	HGL-1/4-QS-10	★ 530042
	G3/8	QS-8	G1/4	830	1200	HGL-3/8-QS-8	★ 530043
	G3/8	QS-10	G1/4	890	1300	HGL-3/8-QS-10	★ 530044
	G1/2	QS-12	G3/8	1400	2100	HGL-1/2-QS-12	★ 530045
<b>Threaded connection at both ends</b>							
<span style="border: 1px solid black; padding: 0 2px;">3</span>	M5	M5	M5	130	200	HGL-M5-B	★ 530029
<span style="border: 1px solid black; padding: 0 2px;">4</span>	G1/8	G1/8	M5	300	430	HGL-1/8-B	★ 530030
	G1/4	G1/4	G1/8	550	680	HGL-1/4-B	★ 530031
	G3/8	G3/8	G1/4	1100	1500	HGL-3/8-B	★ 530032
	G1/2	G1/2	G3/8	1600	2100	HGL-1/2-B	★ 530033

## One-way flow control valves GRLA, GRLZ ★



- Sturdy metal design
- Can be swivelled 360° around the screw-in axis after mounting
- Push-in connector
- Flow rate 100 ... 1580 l/min

- 1 GRLA-QS-D/GRLZ-QS-D:  
with slotted head screw
- 2 GRLA-QS-RS-D:  
with knurled screw

## Order code – Basic design

001 002 003 004 005 006 007  
 -  -  -  -  -  -

Legend:  Mandatory entry  Optional entry

001	Type
GRLA	One-way flow control valve for exhaust air, elbow outlet
GRLZ	One-way flow control valve for supply air, elbow outlet
002	Pneumatic connection 2
M5	Male thread M5
1/8	Male thread G1/8
1/4	Male thread G1/4
3/8	Male thread G3/8
1/2	Male thread G1/2
003	Pneumatic connection 1, connection type
QS	Push-in connector

004	Pneumatic connection 1, tubing O.D. [mm]
...	3, 4, 6, 8, 10, 12
005	Adjusting element
-	Slotted head screw
RS	Knurled screw
006	Flow rate characteristic
-	Without
MF	Medium flow
007	Generation
D	D series

## Product options

## One-way flow control valves

GRLSA Elbow outlet, with rotary knob  
 GR Straight design  
 CRGRLA Stainless steel

## Pneumatic connection

M3 Male thread M3  
 QS-3 Push-in connector 3 mm

## Flow rate characteristic

LF Low flow

 Configurable product

This product and all its product options can be ordered online via the configurator:

→ [www.festo.com/catalogue/grla](http://www.festo.com/catalogue/grla)

Flow control valves >

One-way flow control valves GRLA, GRLZ ★

Ordering – Basic design

Pneumatic connection		Standard nominal flow rate qnN at 6 bar → 5 bar		Standard flow rate qn at 6 bar → 0 bar		Type	Part no.
		In flow control direction	In non-return direction	In flow control direction	In non-return direction		
002	003/004	[l/min]	[l/min]	[l/min]	[l/min]		
<b>001 GRLA: for exhaust air, 005 With slotted head screw</b>							
M5	QS-3	100	60 ... 100	145	150 ... 170	GRLA-M5-QS-3-D	★ 193137
	QS-4	110	65 ... 110	165	140 ... 160	GRLA-M5-QS-4-D	★ 193138
	QS-6	115	70 ... 110	185	145 ... 170	GRLA-M5-QS-6-D	★ 193139
G1/8	QS-3	130	100 ... 130	180	200 ... 220	GRLA-1/8-QS-3-D	★ 193142
	QS-4	160	120 ... 190	250	270 ... 300	GRLA-1/8-QS-4-D	★ 193143
	QS-6	185	160 ... 240	370	330 ... 390	GRLA-1/8-QS-6-D	★ 193144
	QS-8	215	175 ... 250	400	330 ... 410	GRLA-1/8-QS-8-D	★ 193145
G1/4	QS-6	400	290 ... 420	600	570 ... 680	GRLA-1/4-QS-6-D	★ 193146
	QS-8	475	325 ... 500	720	610 ... 760	GRLA-1/4-QS-8-D	★ 193147
	QS-10	480	345 ... 500	760	630 ... 790	GRLA-1/4-QS-10-D	★ 193148
G3/8	QS-6	495	320 ... 495	740	840 ... 890	GRLA-3/8-QS-6-D	★ 193149
	QS-8	820	450 ... 850	1300	1080 ... 1420	GRLA-3/8-QS-8-D	★ 193150
	QS-10	900	540 ... 975	1400	1160 ... 1620	GRLA-3/8-QS-10-D	★ 193151
G1/2	QS-12	1580	925 ... 1605	2220	1910 ... 2500	GRLA-1/2-QS-12-D	★ 193152
<b>001 GRLA: for exhaust air, 005 With slotted head screw, 006 Mid flow</b>							
G1/8	QS-6	400	290 ... 420	600	570 ... 680	GRLA-1/8-QS-6-MF-D	★ 537075
	QS-8	475	325 ... 500	720	610 ... 760	GRLA-1/8-QS-8-MF-D	★ 537076
<b>001 GRLA-RS: for exhaust air, 005 With knurled screw</b>							
M5	QS-3	100	60 ... 100	145	150 ... 170	GRLA-M5-QS-3-RS-D	★ 197576
	QS-4	110	65 ... 110	165	140 ... 160	GRLA-M5-QS-4-RS-D	★ 197577
	QS-6	115	70 ... 110	185	145 ... 170	GRLA-M5-QS-6-RS-D	★ 197578
G1/8	QS-3	130	100 ... 130	180	200 ... 220	GRLA-1/8-QS-3-RS-D	★ 197579
	QS-4	160	120 ... 190	250	270 ... 300	GRLA-1/8-QS-4-RS-D	★ 197580
	QS-6	185	160 ... 240	370	330 ... 390	GRLA-1/8-QS-6-RS-D	★ 197581
	QS-8	215	175 ... 250	400	330 ... 410	GRLA-1/8-QS-8-RS-D	★ 534337
G1/4	QS-6	400	290 ... 420	600	570 ... 680	GRLA-1/4-QS-6-RS-D	★ 534338
	QS-8	475	325 ... 500	720	610 ... 760	GRLA-1/4-QS-8-RS-D	★ 534339
	QS-10	480	345 ... 500	760	630 ... 790	GRLA-1/4-QS-10-RS-D	★ 534340
G3/8	QS-6	495	320 ... 495	740	840 ... 890	GRLA-3/8-QS-6-RS-D	★ 534341
	QS-8	820	450 ... 850	1300	1080 ... 1420	GRLA-3/8-QS-8-RS-D	★ 534342
	QS-10	900	540 ... 975	1400	1160 ... 1620	GRLA-3/8-QS-10-RS-D	★ 534343
G1/2	QS-12	1580	925 ... 1605	2220	1910 ... 2500	GRLA-1/2-QS-12-RS-D	★ 534344

Pneumatic connection		Standard nominal flow rate qnN at 6 bar → 5 bar		Standard flow rate qn at 6 bar → 0 bar		Type	Part no.
		In flow control direction	In non-return direction	In flow control direction	In non-return direction		
002	003/004	[l/min]	[l/min]	[l/min]	[l/min]		
<b>001 GRLZ: for supply air, 005 With slotted head screw</b>							
M5	QS-3	100	60 ... 100	135	130 ... 160	GRLZ-M5-QS-3-D	★ 193153
	QS-4	110	65 ... 110	160	150 ... 180	GRLZ-M5-QS-4-D	★ 193154
	QS-6	115	70 ... 110	170	160 ... 200	GRLZ-M5-QS-6-D	★ 193155
G1/8	QS-3	130	100 ... 130	200	180 ... 200	GRLZ-1/8-QS-3-D	★ 193156
	QS-4	160	120 ... 190	300	260 ... 290	GRLZ-1/8-QS-4-D	★ 193157
	QS-6	185	160 ... 240	340	390 ... 460	GRLZ-1/8-QS-6-D	★ 193158
	QS-8	215	175 ... 250	370	390 ... 470	GRLZ-1/8-QS-8-D	★ 193159



## One-way flow control valves GRLA, GRLZ ★

## Basic design – in combination with drive

Pneumatic connection		Type	Part no.	For piston Ø										
002	003/004			ADN → 26	DSBC → 29	DSNU → 32	DSNU → 34	DSNU-S → 36	ADVC → 39	AEVC → 39	DRVS → 42	DRRD → 44	DGST → 46	DFM → 48
<b>001 GRLA: for exhaust air, 005 With slotted head screw</b>														
M5	QS-3	GRLA-M5-QS-3-D	★ 193137	12, 16, 20, 25	–	12, 16	–	12, 16	12, 16, 20, 25	–	12, 16, 25	16, 20, 25	8, 10, 12, 16	12, 16, 20
	QS-4	GRLA-M5-QS-4-D	★ 193138											
	QS-6	GRLA-M5-QS-6-D	★ 193139											
G1/8	QS-3	GRLA-1/8-QS-3-D	★ 193142	32, 40, 50, 63, 80	32	20, 25	32	20, 25	32, 40, 50, 63	–	32, 40	32, 35, 40	20	25, 32, 40
	QS-4	GRLA-1/8-QS-4-D	★ 193143											
	QS-6	GRLA-1/8-QS-6-D	★ 193144											
	QS-8	GRLA-1/8-QS-8-D	★ 193145											
G1/4	QS-6	GRLA-1/4-QS-6-D	★ 193146	–	40, 50	–	–	–	–	–	–	–	–	50, 63
	QS-8	GRLA-1/4-QS-8-D	★ 193147											
	QS-10	GRLA-1/4-QS-10-D	★ 193148											
G3/8	QS-6	GRLA-3/8-QS-6-D	★ 193149	–	63, 80	–	–	–	–	–	–	–	–	–
	QS-8	GRLA-3/8-QS-8-D	★ 193150											
	QS-10	GRLA-3/8-QS-10-D	★ 193151											
G1/2	QS-12	GRLA-1/2-QS-12-D	★ 193152	–	100, 125	–	–	–	–	–	–	–	–	–
<b>001 GRLA: for exhaust air, 005 With slotted head screw, 006 Mid flow</b>														
G1/8	QS-6	GRLA-1/8-QS-6-MF-D	★ 537075	32, 40, 50, 63, 80	32	20, 25	32	–	32, 40, 50, 63	–	32, 40	32, 35, 40	20	25, 32, 40
	QS-8	GRLA-1/8-QS-8-MF-D	★ 537076											
<b>001 GRLA-RS: for exhaust air, 005 With knurled screw</b>														
M5	QS-3	GRLA-M5-QS-3-RS-D	★ 197576	12, 16, 20, 25	–	12, 16	–	–	12, 16, 20, 25	–	12, 16, 25	16, 20, 25	8, 10, 12, 16	12, 16, 20
	QS-4	GRLA-M5-QS-4-RS-D	★ 197577											
	QS-6	GRLA-M5-QS-6-RS-D	★ 197578											
G1/8	QS-3	GRLA-1/8-QS-3-RS-D	★ 197579	32, 40, 50, 63, 80	32	20, 25	32	–	32, 40, 50, 63	–	32, 40	32, 35, 40	20	25, 32, 40
	QS-4	GRLA-1/8-QS-4-RS-D	★ 197580											
	QS-6	GRLA-1/8-QS-6-RS-D	★ 197581											
	QS-8	GRLA-1/8-QS-8-RS-D	★ 534337											
G1/4	QS-6	GRLA-1/4-QS-6-RS-D	★ 534338	–	40, 50	–	–	–	–	–	–	–	–	50, 63
	QS-8	GRLA-1/4-QS-8-RS-D	★ 534339											
	QS-10	GRLA-1/4-QS-10-RS-D	★ 534340											
G3/8	QS-6	GRLA-3/8-QS-6-RS-D	★ 534341	–	63, 80	–	–	–	–	–	–	–	–	–
	QS-8	GRLA-3/8-QS-8-RS-D	★ 534342											
	QS-10	GRLA-3/8-QS-10-RS-D	★ 534343											
G1/2	QS-12	GRLA-1/2-QS-12-RS-D	★ 534344	–	100, 125	–	–	–	–	–	–	–	–	–

Pneumatic connection		Type	Part no.	Piston Ø										
002	003/004			ADN → 26	DSBC → 29	DSNU → 32	DSNU → 34	DSNU-S → 36	ADVC → 39	AEVC → 39	DRVS → 42	DRRD → 44	DGST → 46	DFM → 48
<b>001 GRLZ: for supply air, 005 With slotted head screw</b>														
M5	QS-3	GRLZ-M5-QS-3-D	★ 193153	–	–	–	–	–	–	12, 16, 20, 25	–	–	–	–
	QS-4	GRLZ-M5-QS-4-D	★ 193154											
	QS-6	GRLZ-M5-QS-6-D	★ 193155											
G1/8	QS-3	GRLZ-1/8-QS-3-D	★ 193156	–	–	–	–	–	–	32, 40, 50, 63	–	–	–	–
	QS-4	GRLZ-1/8-QS-4-D	★ 193157											
	QS-6	GRLZ-1/8-QS-6-D	★ 193158											
	QS-8	GRLZ-1/8-QS-8-D	★ 193159											

# 08

## Valve terminals

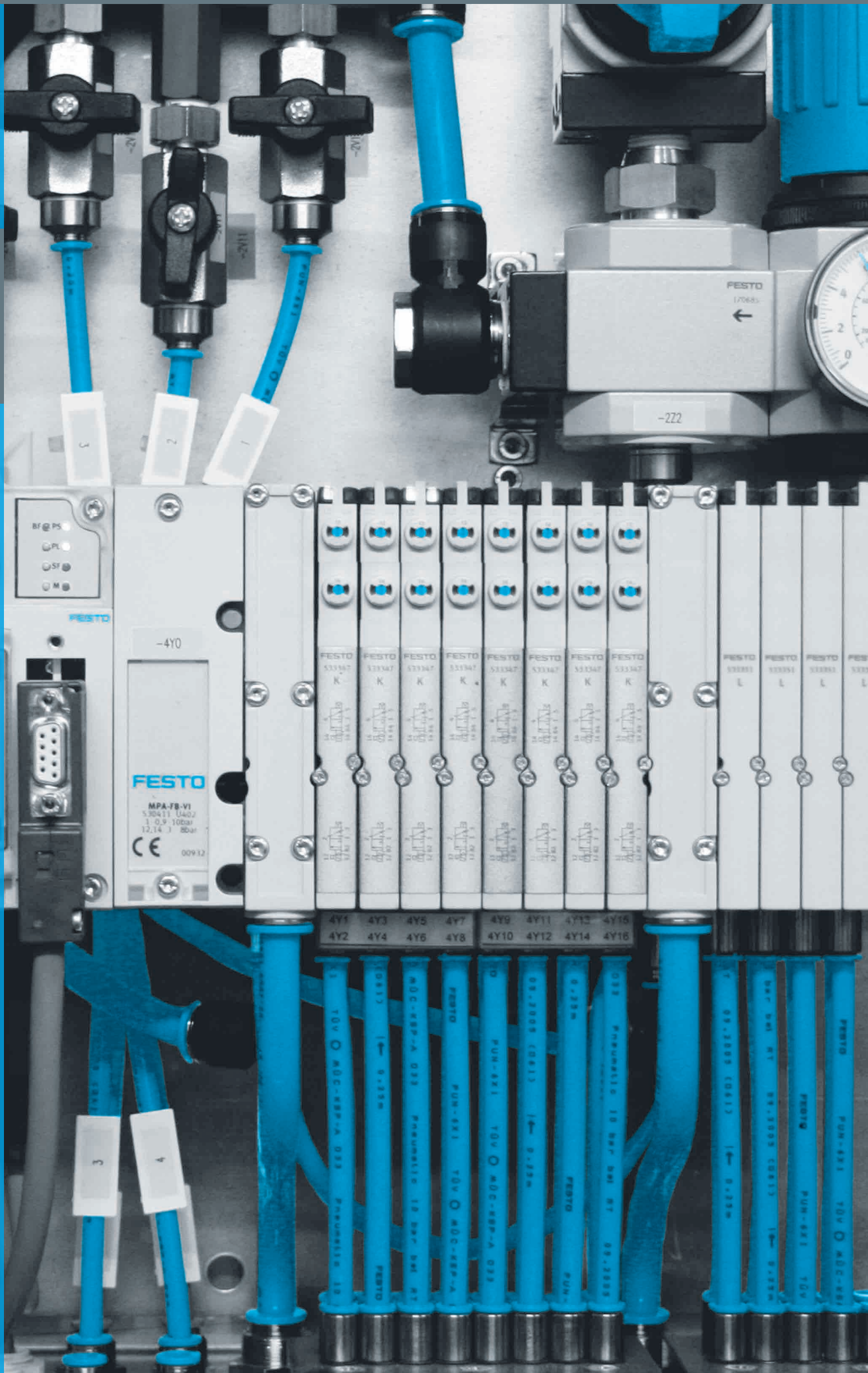

# Highlights

# Contents

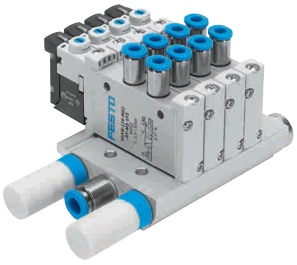

Valve manifolds with individual electrical connection

**VTUG-S**

- + Compact universal series
- + High flow rate

→ 114

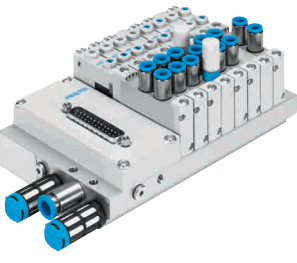

Valve terminals with multi-pin plug or fieldbus connection

**VTUG**

- + Energy-efficient thanks to reverse operation and targeted pressure reduction
- + Especially suitable for control cabinet installation

→ 114



Valve terminals

**MPA-S**

- + Extremely flexible
- + Open to PROFIBUS-DP, INTERBUS®, CANopen, DeviceNet®, CC-LINK®

→ 115

Product overview \_\_\_\_\_ 114

Product overview

Software-Tools

Product Finder for valve terminals



Find the right valve terminal quickly with the help of the Product Finder.

Start the Product Finder by clicking on the blue button "Product Finder" under "Products". Select the technical features on the left-hand side step-by-step; the selection of suitable products on the right-hand side is automatically updated to reflect the chosen technical features.

The use of logic checks ensures that only correct configurations are available for selection.

The Product Finder for valve terminals is part of the electronic catalogue and is not available as a separate software program.

This tool can be found

- on our website at [www.festo.com/catalogue](http://www.festo.com/catalogue) by clicking on the blue button "Product Finder".

Universal valve terminals



Valve manifolds VTUG-S



Valve terminals with multi-pin plug/fieldbus connection VTUG





Valve manifolds VTUS



Valve terminals MPA-L

<b>Width</b>	10 mm, 14 mm, 18 mm	10 mm, 14 mm, 18 mm	21 mm, 26.5 mm, 31 mm	10 mm, 14 mm, 20 mm
<b>Standard nominal flow rate</b>	380 l/min at 10 mm, 780 l/min at 14 mm, 1380 l/min at 18 mm	330 l/min at 10 mm, 630 l/min at 14 mm, 1200 l/min at 18 mm	600 ... 2300 l/min	360 l/min at 10 mm, 670 l/min at 14 mm, 870 l/min at 20 mm
<b>Max. no. of valve positions</b>	16	24	16	32
<b>Electrical actuation</b>	Individual connection	Individual connection, fieldbus, multi-pin plug, IO-Link®, I-Port	Individual connection	Fieldbus, multi-pin plug, IO-Link®, I-Port
<b>Valve terminal design</b>	Fixed grid	Fixed grid	Fixed grid	Valve sizes can be mixed
<b>Description</b>	<ul style="list-style-type: none"> <li>• Compact with small valves VUVG</li> <li>• Connection technology easy to change via the E-box</li> <li>• Wide range of valve functions</li> <li>• Also with semi in-line valves</li> </ul>	<ul style="list-style-type: none"> <li>• Low-cost fixed grid</li> <li>• Extremely easy assembly</li> <li>• Exchangeable electrical actuation</li> <li>• IO-Link® capable</li> <li>• Valves VUVG with individual electrical connection can be integrated</li> <li>• Also available with pneumatic multiple connector plate</li> <li>• Part of the VG series</li> <li>• Energy-efficient thanks to reverse operation and targeted pressure reduction</li> <li>• Optimised and space-saving variant available for installation in control cabinets</li> <li>• Variants with hot-swap connections: valves can be replaced during operation</li> </ul>	<ul style="list-style-type: none"> <li>• Robust valves with long service life VUVS</li> <li>• Individual electrical connection</li> <li>• Pilot air supply in the manifold rail</li> <li>• Comprehensive range of accessories</li> </ul>	<ul style="list-style-type: none"> <li>• Maximum modularity</li> <li>• Individual granularity</li> <li>• Polymer sub-base</li> <li>• 3 valve sizes</li> <li>• Tamper-proof fixed flow restrictor</li> <li>• Fieldbus connection via CPX</li> <li>• IO-Link® capable</li> </ul>
<b>→ Page/online</b>	<a href="#">vtug</a>	<a href="#">vtug</a>	<a href="#">vtus</a>	<a href="#">mpa-l</a>

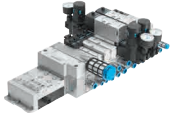
## Universal valve terminals

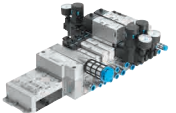

	 Valve terminals MPA-S	 Valve terminals VTSA-F	 Valve terminals VTSA-F-CB	 Valve terminals, Compact Performance CPV10, CPV14, CPV18
<b>Width</b>	10 mm, 14 mm, 20 mm	18 mm, 26 mm, 42 mm, 52 mm, 65 mm	18 mm, 26 mm	10 mm, 14 mm, 18 mm, 18 mm
<b>Standard nominal flow rate</b>	360 l/min at 10 mm, 550 l/min at 14 mm, 700 l/min at 20 mm	700 l/min at 18 mm, 1350 l/min at 26 mm, 1860 l/min at 42 mm, 2900 l/min at 52 mm, 4000 l/min at 65 mm	700 l/min at 18 mm, 1350 l/min at 26 mm	400 l/min, 400 l/min at 10 mm, 800 l/min at 14 mm, 1600 l/min at 18 mm
<b>Max. no. of valve positions</b>	8, 24, 32, 64	32		8
<b>Electrical actuation</b>	AS-Interface, fieldbus, multi-pin plug	Ethernet, fieldbus, multi-pin plug, integrated controller	Fieldbus	AS-Interface®, CPI installation system, individual connection, field- bus, multi-pin plug
<b>Valve terminal design</b>	Modular, valve sizes can be mixed	Modular, valve sizes can be mixed	Modular, valve sizes can be mixed	Fixed grid
<b>Description</b>	<ul style="list-style-type: none"> <li>Valve terminals for universal applications</li> <li>High-performance valves in a sturdy metal housing</li> <li>Metal linking</li> <li>Two valve sizes can be combined</li> <li>Excellent communication thanks to serial linking</li> <li>Fieldbus connection via CPX</li> <li>Max. 128 valves</li> </ul>	<ul style="list-style-type: none"> <li>Flow rate-optimised valve terminal VTSA</li> <li>Linking with increased flow rates</li> <li>Functions like standard valve terminals VTSA</li> </ul>	<ul style="list-style-type: none"> <li>Previous external cabling is now unnecessary, while the installation space remains the same</li> <li>Up to 96 valve addresses and up to four voltage zones, three of which can be safely shut off</li> <li>For applications with increased safety requirements such as manual work stations</li> <li>Five valve sizes can be combined on one valve terminal</li> </ul>	<ul style="list-style-type: none"> <li>Maximum performance in the smallest of spaces</li> <li>Three sizes</li> <li>Wide range of connection and mounting options</li> <li>Multi-pin or fieldbus control</li> <li>IO-Link® capable</li> </ul>
<b>→ Page/online</b>	<a href="#">mpa</a>	<a href="#">vtsa</a>	<a href="#">vtsa</a>	<a href="#">cpv</a>

## Standards-based valve terminals

	 Valve terminals VTSA
<b>Width</b>	18 mm, 26 mm, 42 mm, 52 mm, 65 mm
<b>Max. standard nominal flow rate</b>	550 l/min at 18 mm, 1100 l/min at 26 mm, 1300 l/min at 42 mm, 2900 l/min at 52 mm, 4000 l/min at 65 mm
<b>Max. no. of valve positions</b>	32
<b>Electrical actuation</b>	Ethernet, fieldbus, multi-pin plug, integrated controller
<b>Valve terminal design</b>	Modular, valve sizes can be mixed
<b>Description</b>	<ul style="list-style-type: none"> <li>Conforms to ISO 15407-2/ISO 5599-2</li> <li>Multi-pin plug connection or fieldbus connection via the CPX system</li> <li>Five valve sizes can be combined on one valve terminal</li> <li>Integratable safety functions</li> </ul>
<b>→ Page/online</b>	<a href="#">vtsa</a>

Product overview

Electrical peripherals

	 Terminal CPX	 Fieldbus modules CTEU
<b>Protocol</b>	INTERBUS, DeviceNet, PROFIBUS, CANopen, CC-Link, Ether-Net/IP, PROFINET, EtherCAT, ModbusTCP	AS-Interface, CANopen, CC-Link, CPI-B, DeviceNet, EtherCAT, EtherNet/IP, PROFINET, Modbus® TCP, PROFIBUS DP
<b>Electric actuation</b>	Fieldbus, integrated controller	
<b>Max. address volume for inputs</b>	64 Byte	2 ... 64 Byte
<b>Max. address volume for outputs</b>	64 Byte	2 ... 64 Byte
<b>Parameterisation</b>	Diagnostic behaviour, failsafe response, forcing of channels, signal setup	Activate diagnostics, diagnostic behaviour, failsafe and idle response, failsafe response, IO-Link® mode, watchdog disable, watchdog enable
<b>Degree of protection</b>	IP65, IP67	IP65, IP67
<b>Nominal operating voltage DC</b>	24 V	24 ... 30 V
<b>Operating voltage range DC</b>	18 ... 30 V	18 ... 31.6 V
<b>Description</b>	<ul style="list-style-type: none"> <li>Automation platform</li> <li>Open to all common fieldbus protocols and Ethernet</li> <li>Integrated diagnostic and maintenance functions</li> <li>Applicable as stand-alone remote I/O or with valve terminals MPA-S, MPA-L, VTSA/VTSA-F</li> <li>Choice of polymer or metal interlinking block with individual linking</li> <li>Analogue inputs and outputs, 2-way/4-way, optionally with HART protocol</li> </ul>	<ul style="list-style-type: none"> <li>For valve terminals VTUB-12, VTUG, MPA-L, CPV, VTOC</li> <li>Can be expanded into installation system CTEL</li> <li>Fieldbus-typical LEDs, interfaces and switching elements</li> <li>Isolated power supply for electronics and valves</li> </ul>
<b>→ Page/online</b>	<a href="#">cpx</a>	<a href="#">cteu</a>

Customised components – for your specific requirements



**Valve terminals with customised designs**

Can't find the valve terminal you need in our catalogue?

We can offer you customised components that are tailored to your specific requirements.

Common product modifications:

- Coatings for special ambient conditions
- Customised cables: length, pin allocation, pre-assembled with plug
- Modified actuating elements
- Modified connecting thread
- Modified valve sub-bases

Many additional variants are possible.

Ask your Festo sales engineer, who will be happy to help:

→ [www.festo.com/contact](http://www.festo.com/contact)



# 09

## Sensors





# Highlights



Proximity sensors, for T-slot  
**SME-8M/SMT-8M**  
+ Short design  
+ Variants suitable for use with  
energy chains and robots

→ 125



Pressure sensors  
**SPAN**  
+ Pressure and vacuum  
+ 13 pressure measuring ranges  
+ All standard pressure units

→ 132

# Contents



Product overview	120
Proximity sensors SME-8M/SMT-8M, for T-slot ★	125
Proximity sensors SME-10M/SMT-10M, for C-slot ★	127
Position sensors SRBS ★	129
Pressure sensors SDE5 ★	130
Pressure sensors SPAN ★	132

Product overview

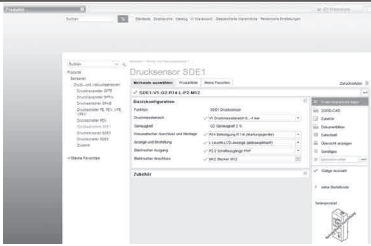
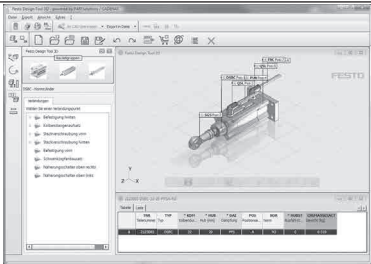

Software-Tools

<p><b>Configurator</b></p> 	<p>Design a product with numerous features reliably and quickly with the help of the configurator.</p> <p>Select all the required product features step-by-step. The use of logic checks ensures that only correct configurations are available for selection.</p> <p>A dynamic graphic generated on the basis of the configuration provides a visual aid for selecting the correct product features.</p> <p>The configurator is part of the electronic catalogue and is not available as a separate software program.</p>
<p><b>Festo Design Tool 3D</b></p> 	<p>The Festo Design Tool 3D is a 3D product configurator for generating specific CAD product combinations from Festo.</p> <p>The configurator makes your search for the right accessory easier, more reliable and faster.</p> <p>You can then order the module that has been created as a single order item, either completely pre-assembled or as individual parts in a single box.</p> <p>This considerably reduces your bill of materials, and downstream processes such as product ordering, order picking and assembly are significantly simplified.</p> <p>All ordering options are available in the following countries: AT, BE, CH, CZ, DE, DK, ES, EST, FI, FR, GB, GR, HU, IE, IT, NL, NO, PL, PT, RU, SE, SI, SK, TR, ZA.</p> <p>This tool can be found</p> <ul style="list-style-type: none"> <li>via the address: <a href="http://www.festo.com/fdt-3d-online">www.festo.com/fdt-3d-online</a> in the countries listed above.</li> </ul>

Proximity sensors, for T-slot

 <p><b>Proximity sensors SMT-8M-A</b></p>	 <p><b>Proximity sensors SME-8, SME-8M</b></p>	
<p><b>Electrical connection</b></p>	<p>Cable, cable with plug, plug, 3-pin, 2-wire, 3-wire, M8x1</p>	
<p><b>Electrical connection 1, connection type</b></p>	<p>Cable, cable with plug</p>	
<p><b>Electrical connection 1, connection technology</b></p>	<p>M8x1 A-coded to EN 61076-2-104, M12x1 A-coded to EN 61076-2-101, open end</p>	
<p><b>Electrical connection 1, occupied pins/wires</b></p>	<p>2, 3</p>	
<p><b>Operating voltage range DC</b></p>	<p>5 ... 30 V</p>	
<p><b>Switching element function</b></p>	<p>N/C, N/C or N/O, switchable, N/O</p>	
<p><b>Switching output</b></p>	<p>NPN, PNP, PNP/NPN switchable, contactless, 2-wire</p>	
<p><b>Description</b></p>	<ul style="list-style-type: none"> <li>Measuring principle: magneto-resistive</li> <li>Short design</li> <li>Variant EX2 for use in potentially explosive areas</li> <li>Insertable in the slot from above, flush with the cylinder profile</li> <li>LED switching status indication</li> <li>LED operating reserve indication</li> <li>Cable length 0.1 ... 30 m</li> </ul>	
<p><b>→ Page/online</b></p>	<p>125</p>	

## Proximity sensors, for C-slot

	 <b>Proximity sensors SME-10, SME-10M</b>	 <b>Proximity sensors SMT-10M, SMT-10G</b>
<b>Electrical connection</b>	2, 3, cable, cable with plug, M8x1 A-coded to EN 61076-2-104, M12x1 A-coded to EN 61076-2-101, open end, 3-pin, 3-wire, M8x1	2, 3, cable, cable with plug, M8x1 A-coded to EN 61076-2-104, M12x1 A-coded to EN 61076-2-101, open end
<b>Operating voltage range DC</b>	5 ... 30 V	5 ... 30 V
<b>Switching element function</b>	N/O	N/O
<b>Switching output</b>	Contacting, bipolar	NPN, PNP, non-contacting, 2-wire
<b>Description</b>	<ul style="list-style-type: none"> <li>• Measuring principle: magnetic reed</li> <li>• Clamped in the C-slot, insertable in the slot from above or lengthwise</li> <li>• LED switching status indication</li> <li>• Cable length 0.3, 2.5 m</li> </ul>	<ul style="list-style-type: none"> <li>• Measuring principle: magneto-resistive</li> <li>• Clamped in the C-slot, insertable in the slot from above or lengthwise</li> <li>• LED switching status indication</li> <li>• Cable length 0.3, 2.5 m</li> </ul>
<b>→ Page/online</b>	<b>127</b>	<b>127</b>

## Inductive sensors



	 <b>Inductive sensors SIEN</b>
<b>Size</b>	4 mm, 6.5 mm, M12, M12x1, M18, M18x1, M30, M30x1.5, M5x0.5, M8x1
<b>Switching output</b>	NPN, PNP
<b>Switching element function</b>	N/C, N/O
<b>Electrical connection</b>	Cable, plug, 3-pin, 3-wire, M8x1, M12x1
<b>Operating voltage range DC</b>	10 ... 30 V
<b>Description</b>	<ul style="list-style-type: none"> <li>• With standards-based switching distance</li> <li>• For DC voltage</li> <li>• Round design</li> <li>• Metric thread</li> <li>• Flush or non-flush mounting</li> <li>• LED switching status indication</li> <li>• Design with metal or polyamide housing</li> </ul>
<b>→ Page/online</b>	<b>sien</b>

## Product overview



### Position sensors

	 <p><b>Position sensors SRBS</b></p>
<b>Design</b>	Round
<b>Sensing range</b>	>270°
<b>Analogue output</b>	50 mA
<b>Electrical connection 1, connection type</b>	Cable with plug
<b>Electrical connection 1, connection technology</b>	M8x1 A-coded to EN 61076-2-104
<b>Electrical connection 1, occupied pins/wires</b>	4
<b>Description</b>	<ul style="list-style-type: none"> <li>• Used to detect rotation of the shaft on semi-rotary drives DRVS and DSM</li> <li>• The sensor can be quickly assembled without having to manually search for switching points</li> <li>• Simple and reliable operation using just one pushbutton directly on the device</li> </ul>
<b>→ Page/online</b>	<b>129</b>

### Pressure and vacuum sensors

	 <p><b>Pressure sensors SDE5</b></p>	 <p><b>Pressure sensors SPAN</b></p>	 <p><b>Pressure sensors SPAE</b></p>
<b>Pressure measuring range</b>	-1 ... 10 bar	-1 ... 16 bar	-1 ... 10 bar
<b>Switching element function</b>	N/C, N/O, switchable	N/C or N/O, switchable	N/C, N/O, switchable
<b>Pneumatic connection</b>	QS-1/4, QS-4, QS-5/32, QS-6	Male thread 1/8 NPT, male thread G1/8, R1/8, female thread G1/8, M5, for tubing O.D. 4	Flange, cartridge 10, push-in sleeve QS-4, QS-6, QS-3, QS-4
<b>Electrical connection</b>	Cable, plug, round design, to EN 60947-5-2, 3-pin, 3-wire, M8x1	Plug, square design, 4-pin	Cable, open end, 3-wire
<b>Display type</b>		Illuminated LCD	LED display, 2-digit
<b>Description</b>	<ul style="list-style-type: none"> <li>• Programmable and configurable pressure switch for simple pressure sensing tasks</li> <li>• Threshold/window comparator</li> <li>• Switching point adjustment by teach-in function</li> <li>• Integrated microprocessor</li> <li>• Switching status indication by an LED visible from all sides</li> <li>• Certification: c UL us Listed (OL), C-Tick</li> </ul>	<ul style="list-style-type: none"> <li>• For monitoring compressed air and non-corrosive gases</li> <li>• For network monitoring, regulator monitoring, leak testing, object detection</li> <li>• Relative measurement method based on a piezo-resistive measuring cell</li> <li>• Serial communication integrated using IO-Link® 1.1</li> <li>• Compact design 30 x 30 mm</li> <li>• High-contrast, blue backlit display</li> </ul>	<ul style="list-style-type: none"> <li>• Electronic pressure sensor with piezoresistive pressure measuring cell, integrated signal processing, numeric pressure indicator in percent, operating key and a switching output, PNP/NPN switchable</li> <li>• Display of minimum and maximum measured value</li> <li>• All parameters entered can be transferred to other SPAEs (replicator function)</li> <li>• IO-Link® communication interface</li> </ul>
<b>→ Page/online</b>	<b>130</b>	<b>132</b>	<b>spae</b>

## Pressure and vacuum sensors

	 Pressure sensors SPAU	 Pressure switches, vacuum switches PEV, VPEV
<b>Pressure measuring range</b>	-1 ... 16 bar	-1 ... 10 bar
<b>Switching element function</b>	N/C or N/O, switchable	Changeover switch
<b>Pneumatic connection</b>	Flange, 1/8 NPT, G1/8, M5, M7, QS-4, QS-5/32, QS-6, R1/4, R1/8	G1/4, G1/8, M5
<b>Electrical connection</b>		Plug, screw terminal, round design, square design, to DIN 43650, to EN 60947-5-2, type A, 4-pin, M8x1, M12x1
<b>Display type</b>	Illuminated LCD, LED	
<b>Description</b>	<ul style="list-style-type: none"> <li>• For monitoring compressed air and non-corrosive gases</li> <li>• With or without display</li> <li>• Transfer of the pressure value as switching signal, analogue signal or via IO-Link® to the connected control system</li> <li>• Maximum flexibility thanks to versatile pneumatic adaptation and switchable electrical outputs</li> </ul>	<ul style="list-style-type: none"> <li>• Mechanical pressure and vacuum switch</li> <li>• Adjustable switching point</li> <li>• Mounting: screw-in, via through-holes or via H-rail</li> <li>• Visual scale for pressure adjustment</li> <li>• Certification: CCC, c UL us – Recognized (OL), RCM</li> </ul>
<b>→ Page/online</b>	<a href="#">spau</a>	<a href="#">pev</a>

## Flow sensors



	 Flow sensors SFAH
<b>Flow measuring range final value</b>	0.1 ... 200 l/min
<b>Operating medium</b>	Argon, nitrogen, compressed air to ISO 8573-1:2010 [6:4:4]
<b>Operating pressure</b>	-0.9 ... 10 bar
<b>Pneumatic connection</b>	Female thread G1/4, G1/8, for tubing O.D. 4, 6, 8
<b>Electrical connection 1, connection type</b>	Plug
<b>Electrical connection 1, connection technology</b>	Connection pattern L1J, M8x1 A-coded to EN 61076-2-104
<b>Description</b>	<ul style="list-style-type: none"> <li>• Process, compressed air, forming gas and pneumatic object monitoring, handling of ultra-small parts, leak test</li> <li>• Compact design 20 x 58 mm</li> <li>• Clear 2-line display</li> <li>• Mounting: H-rail mounting, wall or surface mounting, front panel mounting</li> <li>• Serial communication integrated using IO-Link® 1.1</li> </ul>
<b>→ Page/online</b>	<a href="#">sfah</a>

Product overview

Optical sensors

	 <p>Retro-reflective sensors, diffuse sensors, light barriers <b>S00D</b></p>	 <p>Retro-reflective sensors, diffuse sensors, distance sensor, light barriers <b>S00E</b></p>
<b>Measurement method</b>	Retro-reflective sensor, through-beam sensor, transmitter, receiver, diffuse sensor with background suppression	Retro-reflective sensor, distance sensor, through-beam sensor, transmitter, receiver, diffuse sensor with background suppression, laser contrast sensor, retro-reflective sensor for transparent objects, diffuse sensor
<b>Working range</b>	0 ... 10000 mm	0 ... 12000000 mm
<b>Setting options</b>		IO-Link®, potentiometer, teach-in
<b>Type of light</b>	Laser, red, LED	Laser, red, LED
<b>Switching output</b>	Push-pull	Push-pull
<b>Description</b>	<ul style="list-style-type: none"> <li>• Easy to operate</li> <li>• Quick to commission</li> <li>• Reliable and stable sensing</li> <li>• Attractive price/performance ratio</li> </ul>	<ul style="list-style-type: none"> <li>• Easy to operate</li> <li>• Quick to commission</li> <li>• Reliable and stable sensing</li> <li>• Attractive price/performance ratio</li> </ul>
<b>→ Page/online</b>	<a href="#">s00d</a>	<a href="#">s00e</a>

Sensor boxes

	 <p>Sensor boxes <b>SRBC</b></p>	 <p>Sensor boxes <b>SRBE</b></p>
<b>Operating voltage range AC</b>	0 ... 250 V	0 ... 250 V
<b>Operating voltage range DC</b>	0 ... 175 V	0 ... 60 V
<b>Electrical connection</b>	Screw terminal, 10-pin	Screw terminal, 10-pin, 14-pin
<b>Type of mounting</b>	Via mounting bracket, on flange ISO 5211	Via mounting bracket, on flange ISO 5211
<b>Description</b>	<ul style="list-style-type: none"> <li>• Pre-assembled mounting adapter for ease of installation</li> <li>• The trip cams can be easily set without additional tools</li> <li>• Sturdy, corrosion-resistant design, ideal for use in harsh ambient conditions</li> <li>• Clearly visible 3D position indicator allows rapid sensing of the current position of the quarter turn actuator</li> </ul>	<ul style="list-style-type: none"> <li>• The trip cams can be easily set without additional tools</li> <li>• Sturdy, corrosion-resistant design, ideal for use in harsh ambient conditions</li> <li>• Clearly visible 3D position indicator allows rapid sensing of the current position of the quarter turn actuator</li> </ul>
<b>→ Page/online</b>	<a href="#">205</a>	<a href="#">srbe</a>

## Proximity sensors SME-8M/SMT-8M, for T-slot ★

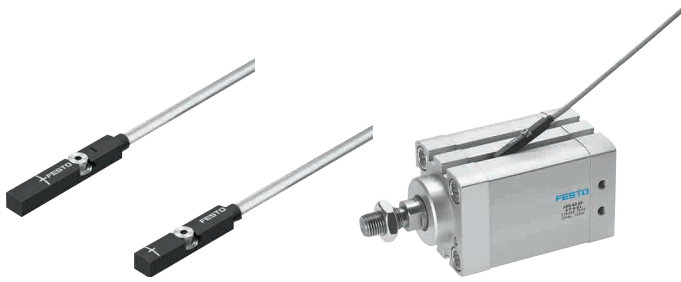

- Switching output via reed contact or non-contacting
- Insertable in the slot from above, does not protrude beyond the cylinder profile
- Variant suitable for use with energy chains and robots
- Cable clip and inscription labels included in the scope of delivery
- With switching status indication
- Selected types in accordance with ATEX directive for potentially explosive atmospheres  
→ [www.festo.com/ex](http://www.festo.com/ex)

## Order code – Basic design

001 002 003 004 005 006 007 008 009 010  
 -  -  -  -  -  -  -  -  -

Legend:  Mandatory entry  Optional entry

001	Type
SME	Proximity sensor, magnetic reed
SMT	Proximity sensor, magneto-resistive
002	Design
8M	For T-slot, insertable in the slot from above
003	Design
-	Standard
A	Short design
004	Switching output, switching element function
DS	N/O, 3-wire
ZS	N/O, 2-wire
DO	N/C, 3-wire
PS	PNP, N/O, 3-wire
NS	NPN, N/O, 3-wire
PO	PNP, N/C, 3-wire
005	Rated operating voltage
24V	24 V DC

006	Cable characteristic
K	Standard + energy chain
E	Energy chain + robot
007	Cable length
0,3	0.3 m
2,5	2.5 m
5,0	5 m
7,5	7.5 m
008	Cable designation
-	With inscription label holder
009	Electrical connection
OE	Open end
M8D	Cable with plug M8x1, rotatable thread
M12	Cable with plug M12x1, rotatable thread
010	EU certification
-	Without
EX2	II 3GD in accordance with EU Directive 2014/34/EU

## Product options

PNS PNP/NPN switchable  
 PSO PNP, N/C, N/O switchable

M8 Cable with plug M8x1,  
 snap-on flange

N Without inscription label  
 holder

Versions:  
 Corrosion-resistant, welding field-re-  
 sistant, heat-resistant

Configurable product

This product and all its product options can be ordered online via the configurator:

→ [www.festo.com/catalogue/sme-8m](http://www.festo.com/catalogue/sme-8m)

Proximity sensors >

Proximity sensors SME-8M/SMT-8M, for T-slot ★

Ordering – Basic design

001 Measuring principle	Switching output	009 Electrical connection			007 Cable length	Type	Part no.
		Cable, open end	Cable with plug, rotatable thread				
			M8x1	M12x1			
<b>003 Standard – 004 N/O contact</b>							
Magnetic reed	Contacting, bipolar	3-wire	–	–	2.5 m	SME-8M-DS-24V-K-2,5-OE	★ 543862
		3-wire	–	–	5 m	SME-8M-DS-24V-K-5,0-OE	★ 543863
		–	3-pin	–	0.3 m	SME-8M-DS-24V-K-0,3-M8D	★ 543861
		2-wire	–	–	2.5 m	SME-8M-ZS-24V-K-2,5-OE	★ 543872
<b>003 Standard – 004 N/C contact</b>							
Magnetic reed	Contacting, bipolar	3-wire	–	–	7.5 m	SME-8M-DO-24V-K-7,5-OE	★ 546799
<b>003 Short design – 004 N/O contact</b>							
Magneto-resistive	PNP	–	3-pin	–	0.3 m	SMT-8M-A-PS-24V-E-0,3-M8D	★ 574334
		3-wire	–	–	2.5 m	SMT-8M-A-PS-24V-E-2,5-OE	★ 574335
		3-wire	–	–	5 m	SMT-8M-A-PS-24V-E-5,0-OE	★ 574336
		–	–	3-pin	0.3 m	SMT-8M-A-PS-24V-E-0,3-M12	★ 574337
	NPN	3-wire	–	–	2.5 m	SMT-8M-A-NS-24V-E-2,5-OE	★ 574338
		–	3-pin	–	0.3 m	SMT-8M-A-NS-24V-E-0,3-M8D	★ 574339
	Non-contacting	2-wire	–	–	5 m	SMT-8M-A-ZS-24V-E-5,0-OE-Ex2	★ 574341
	<b>003 Short design – 004 N/C contact</b>						
Magneto-resistive	PNP	3-wire	–	–	7.5 m	SMT-8M-A-PO-24V-E-7,5-OE	★ 574340

Accessories

Mounting kit SMBR-8		
For Ø	Type	Part no.
8	SMBR-8-8	175091
10	SMBR-8-10	175092
12	SMBR-8-12	★ 175093
16	SMBR-8-16	★ 175094
20	SMBR-8-20	★ 175095
25	SMBR-8-25	★ 175096
32	SMBR-8-32	175097
40	SMBR-8-40	175098

Mounting kit SMBR-8-8		
For Ø	Type	Part no.
8 ... 100	SMBR-8-8/100-S6	★ 538937



Connecting cables, M8, 3-pin			
For SME-8M/SMT-8M with electrical connection M8D			
Cable length	Connection on the right	Type	Part no.
Connection on the left: socket M8, straight, 3-pin			
2.5 m	Open cable end, 3-wire	NEBU-M8G3-K-2.5-LE3	★ 541333
5 m		NEBU-M8G3-K-5-LE3	★ 541334
10 m		NEBU-M8G3-K-10-LE3	★ 541332
Connection on the left: socket M8, angled, 3-pin			
2.5 m	Open cable end, 3-wire	NEBU-M8W3-K-2.5-LE3	★ 541338
5 m		NEBU-M8W3-K-5-LE3	★ 541341
10 m		NEBU-M8W3-K-10-LE3	★ 541335

Connecting cables, M12, 5-pin			
For SMT-8M with electrical connection M12			
Cable length	Connection on the right	Type	Part no.
Connection on the left: socket M12, straight, 5-pin			
2.5 m	Open cable end, 3-wire	NEBU-M12G5-K-2.5-LE3	★ 541363
5 m		NEBU-M12G5-K-5-LE3	★ 541364

Plug, 3-pin		
Can be assembled with any cable lengths		
Electrical connection	Type	Part no.
Insulation displacement connector		
Straight plug, M8x1	NECU-S-M8G3-HX	562024
Straight plug, M12x1	NECU-S-M12G3-HX	562027



Proximity sensors SME-10M/SMT-10M, for C-slot ★



- Switching output PNP, NPN or non-contacting, 2-wire
- Insertable in the slot from above, does not protrude beyond the cylinder profile
- Suitable for use with energy chains and robots
- Cable clip and inscription labels included in the scope of delivery
- With switching status indication

Order code – Basic design

001 002 003 004 005 006 007 008 009  
 - **10M** -  - **24V** - **E** -  - **L** -  -  -

Legend:  Mandatory entry  Optional entry

001	Type
SME	Proximity sensor, magnetic reed
SMT	Proximity sensor, magneto-resistive
002	Design
10M	For C-slot, insertable in the slot from above
003	Switching output, switching element function
PS	PNP, N/O contact, 3-wire
NS	NPN, N/O, 3-wire
ZS	PNP, N/O contact, 2-wire
DS	N/O contact, 3-wire
004	Rated operating voltage
24V	24 V DC
005	Cable characteristic
E	Energy chain + robot

006	Cable length
0,3	0.3 m
2,5	2.5 m
007	Connection direction
L	In-line
008	Cable designation
-	With inscription label holder
009	Connection technology
OE	Open end
M8D	Cable with plug M8x1, rotatable thread

Product options

Q	Lateral cable outlet	M8	Cable with plug M8x1, snap-on flange	Cable length 0.2 ... 10 m
N	Without inscription label holder	M12	Cable with plug M12x1, rotatable thread	

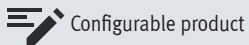

Configurable product

This product and all its product options can be ordered online via the configurator:

→ [www.festo.com/catalogue/sme-10m](http://www.festo.com/catalogue/sme-10m)

Proximity sensors >

Proximity sensors SME-10M/SMT-10M, for C-slot ★

Ordering – Basic design

003 Switching output	007 Cable outlet	Electrical connection		006 Cable length	Type	Part no.
		Cable, open end	Cable with plug, rotatable thread			
003 N/O						
PNP	In-line	3-wire	–	2.5 m	<b>SMT-10M-PS-24V-E-2,5-L-OE</b>	★ 551373
		–	M8x1, 3-pin	0.3 m	<b>SMT-10M-PS-24V-E-0,3-L-M8D</b>	★ 551375
NPN	In-line	3-wire	–	2.5 m	<b>SMT-10M-NS-24V-E-2,5-L-OE</b>	★ 551377
		–	M8x1, 3-pin	0.3 m	<b>SMT-10M-NS-24V-E-0,3-L-M8D</b>	★ 551379
Contactless, 2-wire	In-line	2-wire	–	2.5 m	<b>SMT-10M-ZS-24V-E-2,5-L-OE</b>	★ 551382
Contacting, bipolar	In-line	3-wire	–	2.5 m	<b>SME-10M-DS-24V-E-2,5-L-OE</b>	★ 551365
		–	M8x1, 3-pin	0.3 m	<b>SME-10M-DS-24V-E-0,3-L-M8D</b>	★ 551367
		2-wire	–	2.5 m	<b>SME-10M-ZS-24V-E-2,5-L-OE</b>	★ 551369

Accessories

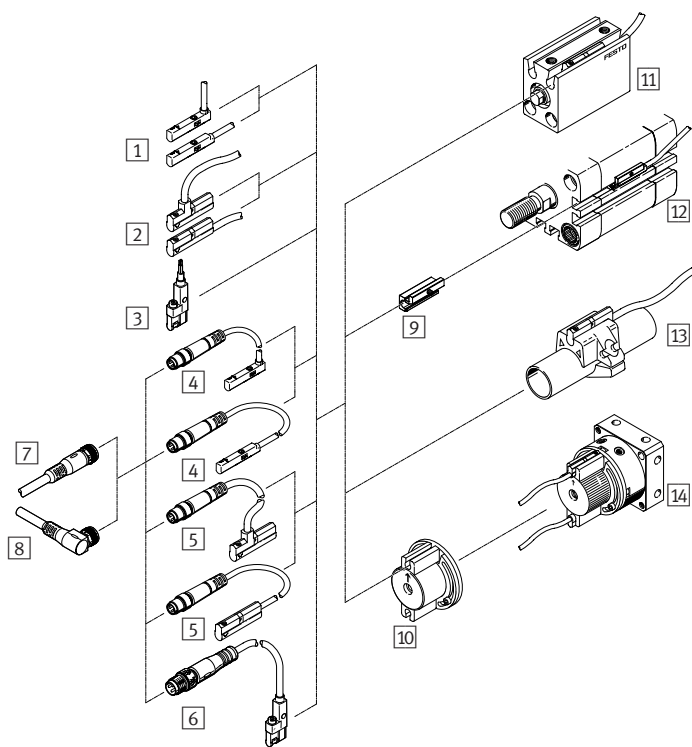

Proximity sensors

- 1 SMT-/SME-10M-...-OE, with cable → 127
  - 2 SME-10, with cable → [sme-10](#)
  - 3 SMT-10G-...-OE, with cable → [smt-10g](#)
  - 4 SMT-/SME-10M-...-M8D, with cable and plug → 127
  - 5 SME-10, with cable and plug → [sme-10](#)
  - 6 SMT-10G-...-M..., with cable and plug → [smt-10g](#)
- Connecting cables
- 7 NEBU-M8G3 → 128
  - 8 NEBU-M8W3 → 128
- Mounting kits
- 9 SMBN-10 → [sme-10](#)
  - 10 WSM-...-SME-10 → [sme-10](#)

Drives

- 11 Drives with C-slot → [dgsi](#)
- 12 Drives with T-slot → 29
- 13 Round cylinders → 32
- 14 Swivel modules DSM → [dsm](#)

7/8 Connecting cables, M8, 3-pin

For SME-10M/SMT-10M with electrical connection M8D

Cable length	Connection on the right	Type	Part no.
Connection on the left: socket M8, straight, 3-pin			
2.5 m	Open cable end, 3-wire	<b>NEBU-M8G3-K-2.5-LE3</b>	★ 541333
5 m		<b>NEBU-M8G3-K-5-LE3</b>	★ 541334
10 m		<b>NEBU-M8G3-K-10-LE3</b>	★ 541332
Connection on the left: socket M8, angled, 3-pin			
2.5 m	Open cable end, 3-wire	<b>NEBU-M8W3-K-2.5-LE3</b>	★ 541338
5 m		<b>NEBU-M8W3-K-5-LE3</b>	★ 541341
10 m		<b>NEBU-M8W3-K-10-LE3</b>	★ 541335

Plug, 3-pin

Can be assembled with any cable lengths

Electrical connection	Type	Part no.
Insulation displacement connector		
Straight plug, M8x1	<b>NECU-S-M8G3-HX-Q3</b>	564945



- Switching output 2x PNP or NPN (programmable)
- Sensing range > 270°
- Cable length 0.3 m
- Electrical connection 4-pin, cable with plug, rotatable thread M8
- Design for semi-rotary drives DRVS  
→ 42

## Order code – Basic design

001	002	003	004	005	006	007	008	009
SRBS			E	270	EP	1	S	M8

Legend:  Mandatory entry

001	Type
SRBS	Position sensor
002	Designation
Q12	Version Q12 for semi-rotary drive DRVS/swivel module DSM
Q1	Version Q1 for swivel module DSM
003	Size
...	6, 8, 10, 12, 16, 25, 32, 40
004	Display type
E	LED
005	Measuring range
270	0 ... 270°

006	Sensor principle
EP	Non-contacting, programmable switching function
007	Nominal operating voltage
1	24 V DC
008	Electrical output
S	PNP or NPN
009	Electrical connection
M8	M8 plug

## Product options

Size 63

Configurable product

This product and all its product options can be ordered online via the configurator:

→ [www.festo.com/catalogue/srbs](http://www.festo.com/catalogue/srbs)

## Ordering – Basic design

002 Designation for semi-rotary drives	Size	Type	Part no.
DRVS → 42	6	SRBS-Q12-6-E270-EP-1-S-M8	★ 2619969
	8	SRBS-Q12-8-E270-EP-1-S-M8	★ 2619972
	12	SRBS-Q12-12-E270-EP-1-S-M8	★ 2393546
	16	SRBS-Q12-16-E270-EP-1-S-M8	★ 2393547
	25	SRBS-Q12-25-E270-EP-1-S-M8	★ 2393548
	32	SRBS-Q12-32-E270-EP-1-S-M8	★ 2393549
	40	SRBS-Q12-40-E270-EP-1-S-M8	★ 2393550

002 Designation for semi-rotary drives	Size	Type	Part no.
DSM → dsm	6	SRBS-Q12-6-E270-EP-1-S-M8	★ 2619969
	8	SRBS-Q12-8-E270-EP-1-S-M8	★ 2619972
	10	SRBS-Q1-10-E270-EP-1-S-M8	★ 2412001

## Accessories

Connecting cables NEBU-M8G4, M8x1, straight socket			
Cable length	Connection on the right	Type	Part no.
Connection on the left: straight socket, M8x1, 4-pin			
2.5 m	Cable, open end, 4-wire	NEBU-M8G4-K-2.5-LE4	541342
5 m		NEBU-M8G4-K-5-LE4	541343

Pressure and vacuum sensors >  
**Pressure sensors SDE5** ★

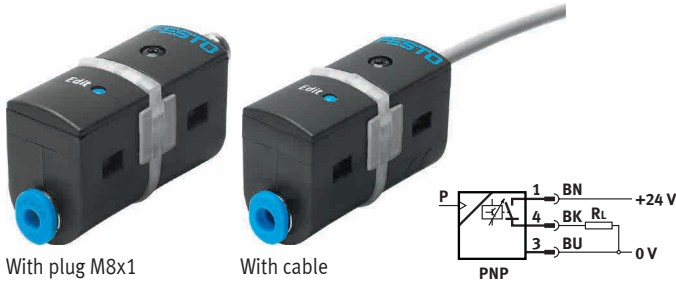

- Programmable and configurable pressure switch for simple pressure sensing tasks
- Relative pressure or differential pressure measurement
- Teach-in function for programming
- Switching status indication by an LED visible from all sides

**Order code – Basic design**

001 002 003 004 005 006 007  
**SDE5** - [ ] - [ ] - [ ] - [ ] - **P** - [ ]

**Legend:** [ ] Mandatory entry [ ] Optional entry

<b>001</b>	Type
<b>SDE5</b>	Pressure sensor
<b>002</b>	Pressure measuring range
<b>D2</b>	0 ... 2 bar
<b>D10</b>	0 ... 10 bar
<b>V1</b>	0 ... -1 bar
<b>003</b>	Supply port
-	Relative pressure
<b>004</b>	Output function
<b>FP</b>	Freely programmable (switching/teach-in function, N/O contact, N/C contact)
<b>O</b>	Threshold value with fixed hysteresis, 1 teach-in pressure, N/O
<b>C</b>	Threshold value with fixed hysteresis, 1 teach-in pressure, N/C
<b>O1</b>	Threshold value with fixed hysteresis, 2 teach-in pressures, N/O
<b>O2</b>	Threshold value with variable hysteresis, 2 teach-in pressures, N/O
<b>O3</b>	Window comparator with fixed hysteresis, 2 teach-in pressures, N/O
<b>C3</b>	Window comparator with fixed hysteresis, 2 teach-in pressures, N/C

<b>005</b>	Pneumatic connection
<b>Q4</b>	Push-in connector at both ends, for tubing O.D. 4 mm
<b>Q6</b>	Push-in connector at both ends, for tubing O.D. 6 mm
<b>Q4E</b>	Push-in connector at one end, for tubing O.D. 4 mm
<b>Q6E</b>	Push-in connector at one end, for tubing O.D. 6 mm
<b>006</b>	Electrical output
<b>P</b>	1 switching output PNP
<b>007</b>	Electrical connection
<b>K</b>	2.5 m cable, open end, 3-wire
<b>M8</b>	Plug M8x1, 3-pin

**Product options**

Pressure measuring range	Output function
D6 0 ... 6 bar	NF No binary switching function (analogue output)
Pressure inlet	
Z Differential pressure	

Pneumatic connection	Electrical accessories
T52 Push-in connector 5/32"	- Connecting cables
T14 Push-in connector 1/4"	- X teach-in point permanently set
	- X teach-in point negative
Electrical output	- Y teach-in point permanently set
N 1 switching output NPN	- Y teach-in point negative
V 1 analogue output 0 ... 10 V	

Configurable product

This product and all its product options can be ordered online via the configurator:

→ [www.festo.com/catalogue/sde5](http://www.festo.com/catalogue/sde5)

## Ordering – Basic design

004 Output function		002 Pressure measuring range						
		V1: 0 ... -1 bar		D2: 0 ... 2 bar		D10: 0 ... 10 bar		
		Type	Part no.	Type	Part no.	Type	Part no.	
<b>004 Freely programmable, (switching/teach-in function, N/O, N/C)</b>								
FP	-		-		SDE5-D10-FP-Q6E-P-M8		★ 542897	
	SDE5-V1-FP-Q6-P-M8		★ 542887			SDE5-D10-FP-Q6-P-M8		★ 542898
	-				SDE5-D10-FP-Q4E-P-K		★ 542901	
	-				SDE5-D10-FP-Q4E-P-M8		★ 542900	
						SDE5-D10-FP-Q6-P-K		★ 542899
<b>004 Threshold value with fixed hysteresis, 1 teach-in pressure, N/O</b>								
O	SDE5-V1-O-Q6E-P-M8		★ 527461			SDE5-D10-O-Q6E-P-M8		★ 527467
	-				SDE5-D2-O-Q6E-P-K		★ 542888	
	SDE5-V1-O-Q6-P-M8		★ 527458			SDE5-D10-O-Q6-P-M8		★ 527464
	SDE5-V1-O-Q4E-P-M8		★ 527460			SDE5-D10-O-Q4E-P-M8		★ 527466
	SDE5-V1-O-Q4-P-M8		★ 527457			SDE5-D10-O-Q4-P-M8		★ 527463
<b>004 Threshold value with fixed hysteresis, 1 teach-in pressure, N/C</b>								
C	-				SDE5-D10-C-Q6E-P-M8		★ 542894	
	-				SDE5-D10-C-Q4E-P-M8		★ 542889	
	-				SDE5-D10-C-Q6E-P-K		★ 542895	
<b>004 Threshold value with fixed hysteresis, 2 teach-in pressures, N/O</b>								
O1	SDE5-V1-O1-Q6-P-M8		★ 542886			-		
<b>004 Threshold value with variable hysteresis, 2 teach-in pressures, N/O</b>								
O2	-				SDE5-D10-O2-Q6-P-M8		★ 542892	
	-				SDE5-D10-O2-Q6E-P-M8		★ 542891	
<b>004 Window comparator with fixed hysteresis, 2 teach-in pressures, N/O</b>								
O3	-				SDE5-D10-O3-Q6E-P-K		★ 542893	
<b>004 Window comparator with fixed hysteresis, 2 teach-in pressures, N/C</b>								
C3	-				SDE5-D10-C3-Q6E-P-K		★ 542896	

## Accessories

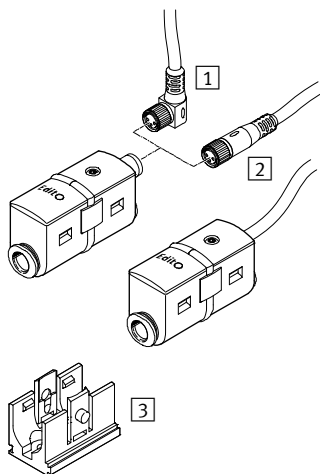

- 1 Connecting cable NEBU-M8W3, angled socket → 131
- 2 Connecting cable NEBU-M8G3, straight socket → 131
- 3 Wall bracket (included in scope of delivery)

1 Connecting cables NEBU-M8W3, M8x1, angled socket			
Cable length	Connection on the right	Type	Part no.
Connection on the left: angled socket, M8x1, 3-pin			
2.5 m	Cable, open end, 3-wire	NEBU-M8W3-K-2.5-LE3	★ 541338
5 m		NEBU-M8W3-K-5-LE3	★ 541341

2 Connecting cables NEBU-M8G3, M8x1, straight socket			
Cable length	Connection on the right	Type	Part no.
Connection on the left: straight socket, M8x1, 3-pin			
2.5 m	Cable, open end, 3-wire	NEBU-M8G3-K-2.5-LE3	★ 541333
5 m		NEBU-M8G3-K-5-LE3	★ 541334

Pressure and vacuum sensors >  
**Pressure sensors SPAN** ★



- For network monitoring, regulator monitoring, leak test and object detection
- Relative method of measurement, based on a piezoresistive measuring cell
- Serial communication integrated using IO-Link® 1.1
- Compact design
- High-contrast display

**Order code – Basic design**

001 002 003 004 005 006 007 008 009  
**SPAN** -  **R** -  - **PN** - **PN** - **L1** -

**Legend:**  Mandatory entry  Optional entry

001	Type
<b>SPAN</b>	Pressure sensor
002	Pressure measuring range
<b>B2</b>	-1 ... +1 bar
<b>P10</b>	0 ... 10 bar
003	Pressure input
<b>R</b>	Relative pressure
004	Pneumatic connection
<b>G18</b>	G1/8
<b>R18</b>	R1/8
<b>M5</b>	M5

005	Thread type
<b>F</b>	Female thread
<b>M</b>	Male thread
006	Electrical output 1
<b>PN</b>	PNP or NPN
007	Electrical output 2
<b>PN</b>	PNP or NPN
008	Electrical connection
<b>L1</b>	Plug design L1
009	Certificates
-	None

**Product options**

Pressure measuring range

B11	-1 ... 10 bar	P6	0 ... 6 bar
P025	0 ... 0.25 bar	P12	0 ... 12 bar
P05	0 ... 0.5 bar	P16	0 ... 16 bar
P1	... 1 bar	V025	0 ... -0.25 bar
P2	0 ... 2 bar	V05	0 ... -0.5 bar
		V1	0 ... -1 bar

Pneumatic connection

Q4	Push-in connector 4 mm
N18	NPT1/8
Electrical output 1	
PNLK	PNP, NPN or IO-Link®

Electrical output 2

PNVBA	PNP, NPN
	0 ... 10 V
	1 ... 5 V
	4 ... 20 mA

Certificates

T	Test report
---	-------------

Configurable product

This product and all its product options can be ordered online via the configurator:

→ [www.festo.com/catalogue/span](http://www.festo.com/catalogue/span)

## Ordering – Basic design

Electrical output			004 Pneumatic connection	Type	Part no.
Switching output	Analogue output	Serial interface			
<b>004 Pressure measuring range B2: -1 ... +1 bar</b>					
2 x PNP/NPN Switchable	-	-	G1/8 male, M5 female	<b>SPAN-B2R-G18M-PN-PN-L1</b>	★ 8035545
			R1/8 male, M5 female	<b>SPAN-B2R-R18M-PN-PN-L1</b>	★ 8035548
			M5 female	<b>SPAN-B2R-M5F-PN-PN-L1</b>	★ 8035551
<b>004 Pressure measuring range P10: 0 ... 10 bar</b>					
2 x PNP/NPN Switchable	-	-	G1/8 male, M5 female	<b>SPAN-P10R-G18M-PN-PN-L1</b>	★ 8035544
			R1/8 male, M5 female	<b>SPAN-P10R-R18M-PN-PN-L1</b>	★ 8035547

## Accessories

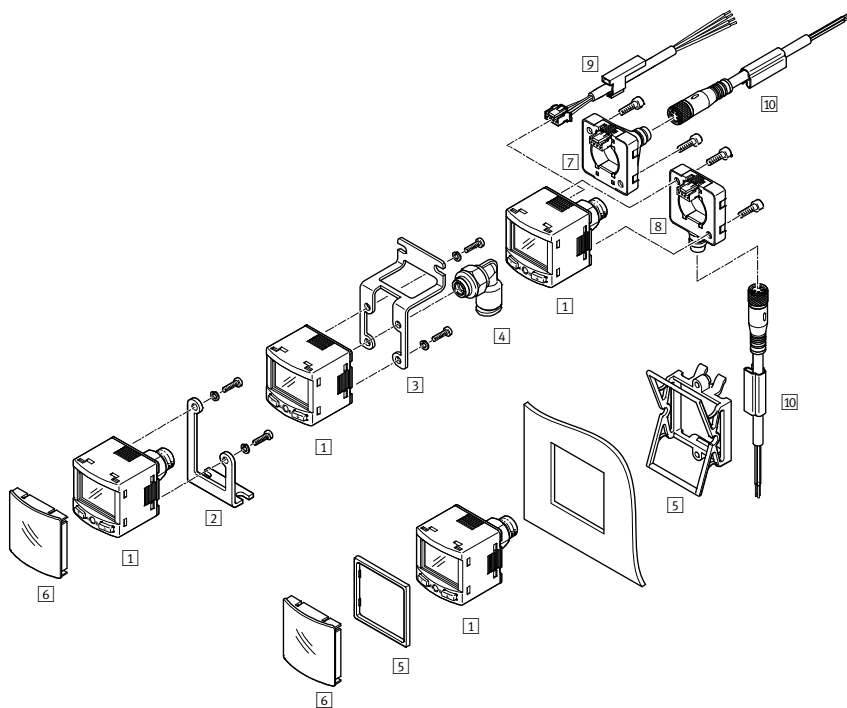

- 1 Pressure sensor SPAN
- 2 Mounting bracket SAMH-PU-A → [span](#)
- 3 Wall mounting SAMH-PN-W → 133
- 4 Push-in fitting QSML-M5 → 133
- 5 Front panel mounting kit SAMH-PN-F → 133
- 6 Safety guard SACC-PN-G → 133
- 7 Electrical adapter (only in combination with NEBU-M8) SASC-P4-A-M8-S → [span](#)
- 8 Electrical adapter (only in combination with NEBU-M8) SASC-P4-A-M8-A → [span](#)
- 9 Connecting cable NEBS-L1G4 → [span](#)
- 10 Connecting cable NEBU-M8G4/NEBU-M8W4 → 133

<b>3 Wall mounting SAMH-PN-W</b>			
Type of mounting	Type	Part no.	
For mounting devices on vertical surfaces			
Via through-hole and screw	<b>SAMH-PN-W</b>	★ 8035563	

<b>4 Push-in fitting QSM, QSML</b>			
Pneumatic connection O.D.	For tubing O.D.	Type	Part no.
<b>Straight connection</b>			
M5	4 mm	<b>QSM-M5-4</b>	★ 153304
	6 mm	<b>QSM-M5-6</b>	★ 153306
G1/8	4 mm	<b>QSM-G1/8-4</b>	★ 186264
	6 mm	<b>QSM-G1/8-6</b>	★ 186265
<b>90° connection</b>			
M5	4 mm	<b>QSML-5-4</b>	★ 153333
	6 mm	<b>QSML-5-6</b>	★ 153335
G1/8	4 mm	<b>QSML-G1/8-4</b>	★ 186268
	6 mm	<b>QSML-G1/8-6</b>	★ 186269

<b>5 Panel mounting kit SAMH-PN-F</b>		
Description	Type	Part no.
Mounting kit for front panel	<b>SAMH-PN-F</b>	★ 8035561

<b>6 Safety guard SACC-PN-G</b>		
Description	Type	Part no.
To protect the display and control elements	<b>SACC-PN-G</b>	★ 8035560

<b>10 Connecting cables NEBU-M8G4, M8x1, straight socket</b>			
Cable length	Connection on the right	Type	Part no.
Connection on the left: straight socket, M8x1, 4-pin			
2.5 m	Cable, open end, 4-wire	<b>NEBU-M8G4-K-2.5-LE4</b>	541342
5 m		<b>NEBU-M8G4-K-5-LE4</b>	541343

<b>10 Connecting cables NEBU-M8W4, M8x1, angled socket</b>			
Cable length	Connection on the right	Type	Part no.
Connection on the left: angled socket, M8x1, 4-pin			
2.5 m	Cable, open end, 4-wire	<b>NEBU-M8W4-K-2.5-LE4</b>	541344
5 m		<b>NEBU-M8W4-K-5-LE4</b>	541345

# 10

## Compressed air preparation





# Highlights



Service units,  
MS series

**MSB**

+ Combinations of filter regulator,  
filter, lubricator, on/off valve and  
soft-start valve

+ Sizes: 4, 6

→ 141



Filter regulators,  
MS series

**MS4/MS6-LFR**

+ Flow rate 850 ... 7200 l/min

+ Sizes: 4, 6

→ 145



Pressure regulators,  
MS series

**MS4/MS6-LR**

+ Flow rate 1000 ... 7500 l/min

+ Sizes: 4, 6

→ 147

# Contents



Product overview	136
Service units MSB4/MSB6, MS series ★	141
Service units MSB4/MSB6-FRC, MS series ★	143
Filter regulators MS4/MS6-LFR, MS series ★	145
Pressure regulators MS4/MS6-LR, MS series ★	147
On/off valves MS4/MS6-EM1, MS4/MS6-EE, MS series ★	149
Soft-start valves MS4/MS6-DL, MS series ★	151
Branching modules MS4/MS6-FRM, MS series ★	153
Distributor blocks MS4/MS6-FRM-FRZ, MS series ★	155
Connecting plates MS4/MS6-AG... ★	156

Product overview

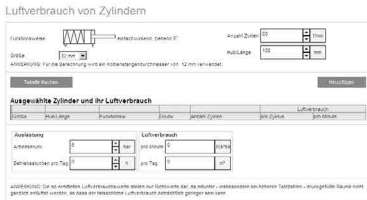
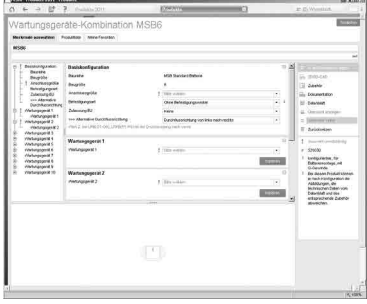
Software-Tools

<p><b>Air consumption</b></p> 	<p>Calculate your system's air consumption quickly and conveniently. Simply enter all the drives and tubing, set the cycle times and working pressure and the air consumption per minute and per day will be calculated for you. It includes a feature for exporting the input table together with the result directly to Excel.</p> <p>This tool can be found</p> <ul style="list-style-type: none"> <li>on our website at <a href="http://www.festo.com/catalogue">www.festo.com/catalogue</a> by clicking on the blue button "Engineering".</li> </ul>
<p><b>Configurator</b></p> 	<p>Design a product with numerous features reliably and quickly with the help of the configurator. Select all the required product features step by step. The use of logic checks ensures that only correct configurations are available for selection.</p> <p>A dynamic graphic generated on the basis of the configuration provides a visual aid for selecting the correct product features.</p> <p>The configurator is part of the electronic catalogue and is not available as a separate software program.</p>

Service units: MS series

	 <p><b>Service units</b> MSB4, MSB6, MSB9</p>	 <p><b>Service units</b> MSE6-E2M</p>
<b>Pneumatic connection 1</b>	G1, G1 1/2, G1 1/4, G1/2, G1/4, G1/8, G3/4, NPT1 1/2-11 1/2, NPT1 1/4-11 1/2, NPT1-11 1/2, NPT1/2-14, NPT3/4-14	G1/2
<b>Standard nominal flow rate</b>	750 ... 18000 l/min	
<b>Flow measuring range final value</b>		5000 l/min
<b>Pressure regulation range</b>	0.5 ... 16 bar	
<b>Operating pressure</b>	0 ... 20 bar	3.5 ... 10 bar
<b>Grade of filtration</b>	0.01 ... 40 µm	
<b>Fieldbus interface</b>		2x socket, M12x1, 4-pin, D-coded, 2x RJ45 push-pull socket, AIDA, 2x SCRJ push-pull socket, AIDA, Sub-D socket, 9-pin
<b>Description</b>	<ul style="list-style-type: none"> <li>Combination of filter regulator, filter, lubricator, on/off valve, soft-start valve</li> <li>Sizes: 4, 6, 9</li> </ul>	<ul style="list-style-type: none"> <li>Intelligent service unit component for optimising the use of compressed air as an energy medium in industrial automation technology</li> <li>Combination of stop valve, flow sensor, pressure sensor and fieldbus node</li> <li>Identification of machine downtimes and leakages</li> <li>User-controlled shut-off and pressurisation</li> <li>Equipped with measurement, control and diagnostic functions</li> <li>Fieldbus connection (PROFIBUS DP, PROFINET IO, EtherNet/IP or EtherCAT®) via integrated fieldbus nodes enables connection to a higher-level controller</li> <li>Size: 6</li> </ul>
<b>→ Page/online</b>	141	<a href="#">mse6</a>

## Filter regulators/lubricators: MS series

	 <p><b>Service units</b> MSB4-FRC, MSB6-FRC</p>
<b>Pneumatic connection 1</b>	G1/2, G1/4, G1/8, G3/8
<b>Standard nominal flow rate</b>	850 ... 4800 l/min
<b>Pressure regulation range</b>	0.3 ... 12 bar
<b>Operating pressure</b>	0.8 ... 20 bar
<b>Grade of filtration</b>	5 µm, 40 µm
<b>Description</b>	<ul style="list-style-type: none"> <li>• Filter, regulator and lubricator functions in a single unit</li> <li>• High flow rate and highly efficient in removing contaminants</li> <li>• Good regulation characteristics with minimal pressure hysteresis</li> <li>• Size 4, 6</li> </ul>
<b>→ Page/online</b>	143

## Filter regulators: MS series



	 <p><b>Filter regulators</b> MS2-LFR, MS4-LFR, MS6-LFR, MS9-LFR, MS12-LFR</p>
<b>Pneumatic connection 1</b>	Internal, G1/2, G1/4, G1/8, G3/8, M5, QS-6
<b>Standard nominal flow rate</b>	140 ... 24000 l/min
<b>Pressure regulation range</b>	0.3 ... 16 bar
<b>Operating pressure</b>	0.8 ... 20 bar
<b>Grade of filtration</b>	5 µm, 40 µm
<b>Description</b>	<ul style="list-style-type: none"> <li>• MS2-LFR, MS4-LFR, MS6-LFR: directly actuated diaphragm regulator, MS9-LFR: piloted or directly actuated filter-diaphragm regulator, MS12-LFR: piloted diaphragm regulator without internal air consumption</li> <li>• Good control characteristics with minimal pressure hysteresis and primary pressure compensation</li> <li>• Good particle and condensate separation</li> <li>• With or without secondary venting</li> <li>• High flow rate</li> <li>• Lockable rotary knob</li> <li>• Return flow option for exhausting from output 2 to input 1 already integrated</li> <li>• Sizes: 2, 4, 6, 9, 12</li> </ul>
<b>→ Page/online</b>	145

Product overview



Filter regulators: Individual devices

	 <p>Filter regulators PCRP</p>
<b>Pneumatic connection 1</b>	G1/2, G1/4, NPT1/2-14, NPT1/4-18
<b>Standard nominal flow rate</b>	1920 ... 4115 l/min
<b>Pressure regulation range</b>	0.5 ... 12 bar
<b>Operating pressure</b>	1 ... 20 bar
<b>Grade of filtration</b>	5 µm, 40 µm
<b>Description</b>	<ul style="list-style-type: none"> <li>• Robust housing for the specific requirements of process automation</li> <li>• Suitable for use outdoors and at temperatures down to -60 °C</li> <li>• Resistant to UV radiation and corrosive environments</li> <li>• With manual condensate drain, rotating</li> <li>• Size: 64</li> </ul>
<b>→ Page/online</b>	<a href="#">pcrp</a>



Regulators: MS series

	 <p>Pressure regulators MS2-LR, MS4-LR, MS6-LR, MS9-LR</p>		 <p>Pressure regulators MS12-LR</p>
<b>Pneumatic connection 1</b>	G1/2, G1/4, G1/8, G3/8, M5, QS-6		Connecting plate
<b>Standard nominal flow rate</b>	170 ... 30000 l/min		12000 ... 22000 l/min
<b>Pressure regulation range</b>	0.3 ... 16 bar		0.15 ... 16 bar
<b>Operating pressure</b>	0.8 ... 20 bar		0.8 ... 21 bar
<b>Max. pressure hysteresis</b>	0.25 ... 0.4 bar		0.04 ... 0.4 bar
<b>Description</b>	<ul style="list-style-type: none"> <li>• High flow rate with minimal pressure drop</li> <li>• Good control characteristics with minimal pressure hysteresis and primary pressure compensation</li> <li>• With or without secondary venting</li> <li>• Lockable rotary knob</li> <li>• Optional pressure sensor and rotary knob pressure gauge</li> <li>• Sizes: 2, 4, 6, 9</li> </ul>		<ul style="list-style-type: none"> <li>• High flow rate with minimal pressure drop</li> <li>• Good control characteristics with minimal pressure hysteresis and primary pressure compensation</li> <li>• With secondary venting</li> <li>• Lockable rotary knob</li> <li>• MS12-LR-...-PO: pneumatically actuated (pressure range determined via pilot control)</li> <li>• MS12-LR-...-PE6: solenoid actuated (pilot control via proportional pressure regulator)</li> <li>• Size: 12</li> </ul>
<b>→ Page/online</b>	<a href="#">147</a>		<a href="#">ms12-lr</a>

### On/off and soft-start valves: MS series



	 <b>On/off valves</b> MS4-EM1, MS6-EM1, MS9-EM, MS12-EM	 <b>On/off valves</b> MS4-EE, MS6-EE, MS9-EE, MS12-EE	 <b>Soft start valves</b> MS4-DL, MS6-DL, MS12-DL
<b>Pneumatic connection 1</b>	Manifold module, G1/2, G1/4, G1/8, G3/8, G3/4, G1	Manifold module, G1/2, G1/4, G1/8, G3/8, G3/4, G1	Manifold module, G1/2, G1/4, G1/8, G3/8
<b>Standard nominal flow rate</b>	1200 ... 32000 l/min	1000 ... 32000 l/min	1000 ... 42000 l/min
<b>Operating pressure</b>	0 ... 20 bar	3 ... 18 bar	2 ... 20 bar
<b>Actuation type</b>	Manual	Electrical	Pneumatic
<b>Description</b>	<ul style="list-style-type: none"> <li>• Manual 3/2-way valve for pressurising and exhausting pneumatic systems</li> <li>• A silencer can be attached or the exhaust air can be ducted at port 3</li> <li>• Switching position is immediately recognisable</li> <li>• Optionally with pressure gauge and pressure sensor</li> <li>• Sizes 4, 6, 9, 12</li> </ul>	<ul style="list-style-type: none"> <li>• Electric 3/2-way valve for pressurising and exhausting pneumatic systems</li> <li>• A silencer can be attached or the exhaust air can be ducted at port 3</li> <li>• Supply voltage 24 V DC, 110, 230 V AC</li> <li>• Optionally with pressure gauge and pressure sensor</li> <li>• With solenoid coil, without plug socket</li> <li>• Sizes 4, 6, 9, 12</li> </ul>	<ul style="list-style-type: none"> <li>• 2/2-way valve for slowly pressurising pneumatic systems (for use with on/off valves EM(1) and EE)</li> <li>• For building up pressure gradually</li> <li>• Adjustable pressure build-up time</li> <li>• Sizes: 4, 6, 12</li> </ul>
→ Page/online	149	149	151

### On/off and soft-start valves: MS series

	 <b>Soft-start/quick exhaust valves</b> MS6-SV-E, MS6-SV-D	 <b>Soft-start/quick exhaust valves</b> MS6-SV-C, MS9-SV-C
<b>Pneumatic connection 1</b>	Manifold module, G1/2	Manifold module, G1/2, G3/4, G1
<b>Standard nominal flow rate</b>	4300 l/min	5700 ... 16550 l/min
<b>Operating pressure</b>	3.5 ... 10 bar	3 ... 16 bar
<b>Actuation type</b>	Electrical	Electrical
<b>Description</b>	<ul style="list-style-type: none"> <li>• Reliable 2-channel exhausting with self-monitoring up to Performance Level e and category 4 to EN ISO 13849-1</li> <li>• For reducing pressure quickly and reliably and for building up pressure gradually</li> <li>• SIL 3</li> <li>• Adjustable pressure build-up time</li> <li>• Optionally with silencer</li> <li>• Supply voltage 24 V DC</li> <li>• Size: 6</li> </ul>	<ul style="list-style-type: none"> <li>• Single-channel exhausting up to Performance Level c and category 1 to EN ISO 13849-1</li> <li>• For reducing pressure quickly and reliably and for building up pressure gradually</li> <li>• Adjustable pressure build-up time</li> <li>• Adjustable switch-through pressure</li> <li>• Supply voltage 24 V DC</li> <li>• Sizes: 6, 9</li> </ul>
→ Page/online	ms6-sv-e	ms6-sv-c

Product overview

Compressed air distributors: MS series

	 <p><b>Branching modules</b> MS4-FRM, MS6-FRM, MS9-FRM, MS12-FRM</p>	 <p><b>Distributor blocks</b> MS4-FRM-FRZ, MS6-FRM-FRZ</p>
<b>Pneumatic connection 1</b>	Manifold module, G1/4, G1/2, G1, G2, G1, G1 1/2, G1 1/4, G1/2, G1/4, G1/8, G3/4, G3/8, NPT1 1/2-11 1/2, NPT1 1/4-11 1/2, NPT1-11 1/2, NPT1/2-14, NPT3/4-14, NPT1-11 1/2	G1/4, G1/2
<b>Standard nominal flow rate in main flow direction 1-&gt;2</b>	1200 ... 50000 l/min	4050 ... 14600 l/min
<b>Operating pressure</b>	0 ... 20 bar	0 ... 20 bar
<b>Description</b>	<ul style="list-style-type: none"> <li>Optionally with integrated non-return function and pressure sensor</li> <li>Outlet at top and bottom</li> <li>Can be used as an intermediate distributor for varying air qualities</li> <li>Optionally with pressure sensor</li> <li>Sizes 4, 6, 9, 12</li> </ul>	<ul style="list-style-type: none"> <li>Slim pneumatic distributor</li> <li>Outlet at top and bottom</li> <li>Can be used as an intermediate distributor for varying air qualities</li> <li>Can be used as an adapter between two pressure regulators with large rotary knob with pressure gauge on size MS4</li> <li>Size 4, 6</li> </ul>
<b>→ Page/online</b>	<b>153</b>	<b>155</b>

Accessories: MS series

	 <p><b>Connecting plates</b> MS4-AG..., MS6-AG...</p>
<b>Pneumatic connection 1</b>	G1/4, G3/8, G1/2, G3/4
<b>Pneumatic connection 2</b>	G1/4, G3/8, G1/2, G3/4
<b>Description</b>	<ul style="list-style-type: none"> <li>Accessories for size MS4, MS6</li> <li>Adapter for pneumatic connection</li> </ul>
<b>→ Page/online</b>	<b>156</b>

Customised components – for your specific requirements

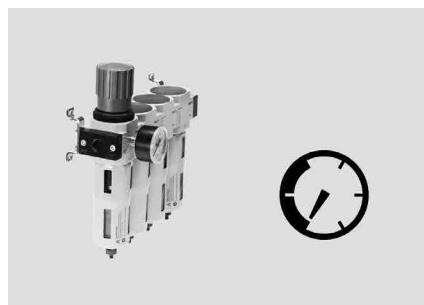

**Components for compressed air preparation with customised designs**

Can't find the compressed air preparation components you need in our catalogue?

We offer you customised components that are tailored to your specific requirements.

Common product modifications:

- Modified pressure range
- Rotary knob: in a special colour, with protection against rotation
- Fitting: integrated throttling port, special thread
- Tubing with special printing
- Pressure gauge with red-green range

Many additional variants are possible.

Ask your Festo sales engineer, who will be happy to help:

→ [www.festo.com/contact](http://www.festo.com/contact)



- For filtered and unlubricated compressed air
- Supply pressure can be opened and closed
- Output pressure is infinitely adjustable within the pressure regulation range
- Flow rate 950 ... 5500 l/min
- Operating pressure 0.8 ... 18 bar
- Grade of filtration 40 µm
- Manual rotary condensate drain

Combinations comprising:

- ① Manually operated on/off valve, filter regulator with lockable pressure gauge, mounting bracket
- ② Manually operated on/off valve, filter regulator with lockable pressure gauge, branching module with pressure switch, mounting bracket

- ③ Manually operated on/off valve, filter regulator with lockable pressure gauge, solenoid actuated on/off valve with pressure sensor for operational status indicator, mounting bracket

### Order code – Basic design

001 002 003 004 005 006  
**MSB**  -  -  : **C3** : **J1** :  - **WP**

Legend:  Mandatory entry  Optional entry

001	Type
<b>MSB</b>	Service unit
002	Size
4	Grid dimension: 40 mm
6	Grid dimension: 62 mm
003	Pneumatic connection
1/4	Thread G1/4
1/2	Thread G1/2
004	Flow direction
-	From left to right

005	Service unit
<b>C3</b>	On/off valve MS4-EM1, MS6-EM1
<b>J1</b>	Filter regulator MS4-LFR-D7-ERM-AS, MS6-LFR-D7-ERM-AS
<b>D14</b>	On/off valve MS4-EE-10V24P-AD7, MS6-EE-10V24P-AD7
<b>F12</b>	Branching module MS4-FRM-AD7, MS6-FRM-AD7
006	Type of mounting
<b>WP</b>	Mounting bracket

### Product options

- Additional connection sizes
- Connecting plates
- Grade of filtration 5 µm
- Service unit components: filter regulators, soft-start valves, lubricators, on/off valves
- Alternative flow direction
- Fully automatic condensate drain

Configurable product

This product and all its product options can be ordered online via the configurator:

→ [www.festo.com/catalogue/msb4](http://www.festo.com/catalogue/msb4)

## Ordering – Basic design

002 Size	003 Pneumatic connection	Condensate drain	Grade of filtration	Type	Part no.
① Manually operated on/off valve, filter regulator with lockable pressure gauge, mounting bracket Pressure regulation range 0.5 ... 12 bar, pressure gauge with outer scale in bar and inner scale in psi					
4	G1/4	Manual rotary	40 µm	<b>MSB4-1/4:C3J1-WP</b>	★ 8025354
6	G1/2	Manual rotary	40 µm	<b>MSB6-1/2:C3J1-WP</b>	★ 8025355
② Manually operated on/off valve, filter regulator with lockable pressure gauge, branching module with pressure sensor, mounting bracket Pressure regulation range 0.5 ... 10 bar, pressure gauge with outer scale in bar and inner scale in psi					
4	G1/4	Manual rotary	40 µm	<b>MSB4-1/4:C3J1F12-WP</b>	★ 8025356
6	G1/2	Manual rotary	40 µm	<b>MSB6-1/2:C3J1F12-WP</b>	★ 8025357
③ Manually operated on/off valve, filter regulator with lockable pressure gauge, solenoid actuated on/off valve with pressure sensor, mounting bracket Pressure regulation range 0.5 ... 10 bar, pressure gauge with outer scale in bar and inner scale in psi					
4	G1/4	Manual rotary	40 µm	<b>MSB4-1/4:C3J1D14-WP</b>	★ 8025358
6	G1/2	Manual rotary	40 µm	<b>MSB6-1/2:C3J1D14-WP</b>	★ 8025359

## Accessories

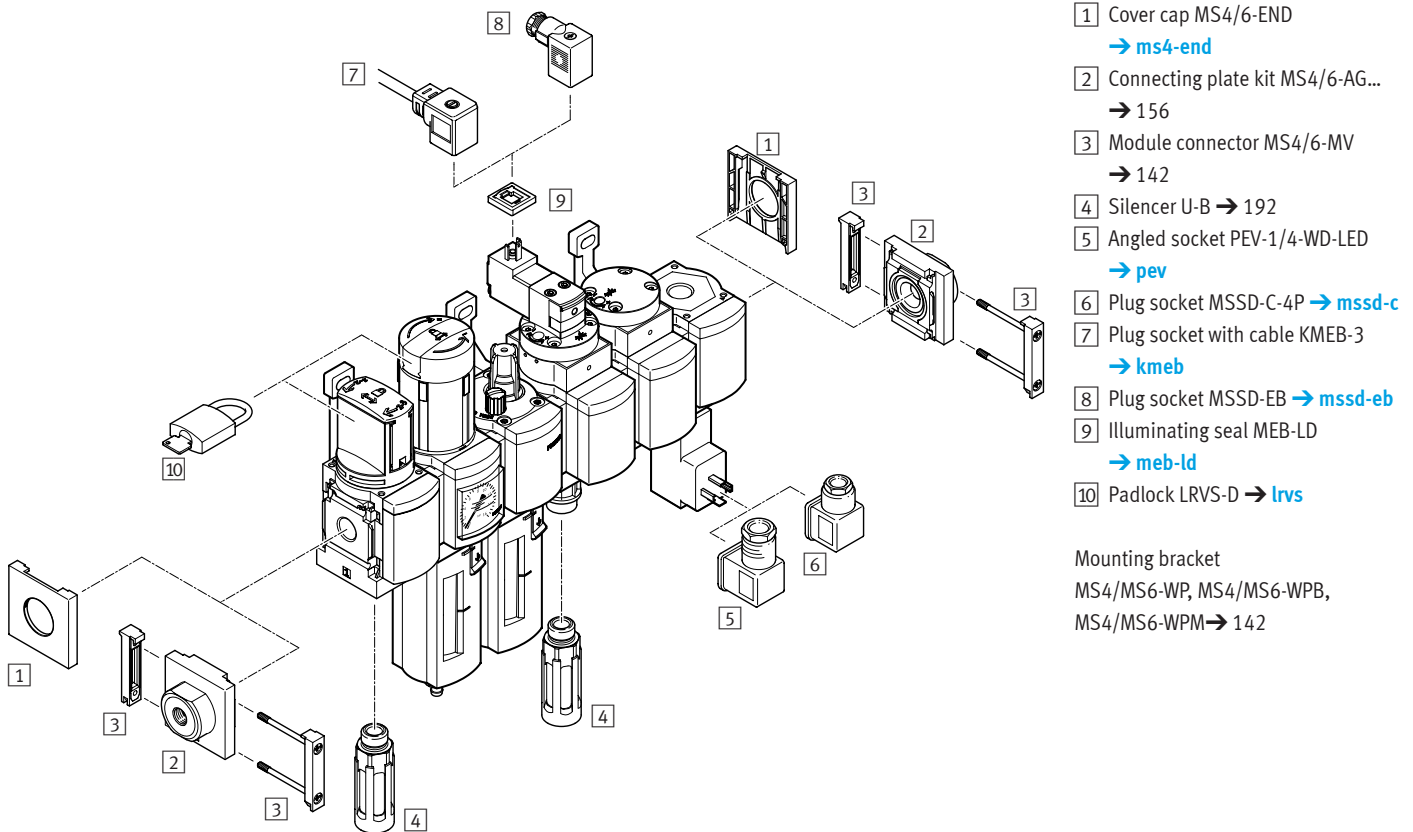

- 1 Cover cap MS4/6-END  
→ [ms4-end](#)
- 2 Connecting plate kit MS4/6-AG...  
→ 156
- 3 Module connector MS4/6-MV  
→ 142
- 4 Silencer U-B → 192
- 5 Angled socket PEV-1/4-WD-LED  
→ [pev](#)
- 6 Plug socket MSSD-C-4P → [mssd-c](#)
- 7 Plug socket with cable KMEB-3  
→ [kmeb](#)
- 8 Plug socket MSSD-EB → [mssd-eb](#)
- 9 Illuminating seal MEB-LD  
→ [meb-ld](#)
- 10 Padlock LRVS-D → [lrvs](#)

Mounting bracket  
MS4/MS6-WP, MS4/MS6-WPB,  
MS4/MS6-WPM → 142

3 Module connector MS4/6-MV		
Size	Type	Part no.
4	<b>MS4-MV</b>	★ 532798
6	<b>MS6-MV</b>	★ 532799

Mounting bracket MS4/6-WPB		
Size	Type	Part no.
For wall mounting		
4	<b>MS4-WPB</b>	★ 526063
6	<b>MS6-WPB</b>	★ 526074

Mounting bracket MS4/6-WPM		
Size	Type	Part no.
For wall mounting		
4	<b>MS4-WPM-D</b>	★ 526060
6	<b>MS6-WPM-D</b>	★ 526073

Mounting bracket MS4/6-WP		
Size	Type	Part no.
For wall mounting		
4	<b>MS4-WP</b>	★ 532184
6	<b>MS6-WP</b>	★ 532195





- Filter, regulator and lubricator functions in a single unit
- High flow rate and highly efficient in removing contaminants
- Good control characteristics with minimal pressure hysteresis
- Set values are secured by locking the rotary knob
- Flow rate 850 ... 4800 l/min
- Operating pressure 1.5 ... 20 bar
- Grade of filtration 40 µm
- Manual rotary condensate drain

## Order code – Basic design

001 002 003 004 005 006  
**MSB**  -  - **FRC5:J1** **M1** -

Legend:  Mandatory entry  Optional entry

001	Type
<b>MSB</b>	Service unit
002	Size
4	Grid dimension: 40 mm
6	Grid dimension: 62 mm
003	Pneumatic connection
1/4	Thread G1/4
1/2	Thread G1/2
004	Service unit combination
<b>FRC5:J1</b>	<ul style="list-style-type: none"> <li>• Filter regulator with pressure gauge, pressure gauge with outer scale in bar and inner scale in psi, grade of filtration 40 µm, pressure regulation range 0.5 ... 12 bar, manually rotating condensate drain, rotary knob with detent, can be locked using accessories, plastic bowl with plastic bowl guard</li> <li>• Lubricator, plastic bowl with plastic bowl guard</li> </ul>

005	Lubricator
<b>M1</b>	Plastic bowl guard
006	Flow direction
-	From left to right

## Product options

- Additional connection sizes
- Grade of filtration 5 µm
- Pressure regulation range 0.3 ... 7 bar
- Metal bowl guard for filter regulator and for lubricator
- Fully automatic condensate drain

Configurable product

This product and all its product options can be ordered online via the configurator:

→ [www.festo.com/catalogue/msb4](http://www.festo.com/catalogue/msb4)

## Ordering – Basic design

002 Size	003 Pneumatic connection	Standard nominal flow rate	Pressure regulation range	Grade of filtration	Type	Part no.
Grade of filtration 40 µm, manual rotary condensate drain						
4	G1/4	900 l/min	0.5 ... 12 bar	40 µm	<b>MSB4-1/4-FRC5:J1M1</b> ★	<b>531117</b>
6	G1/2	3700 l/min	0.5 ... 12 bar	40 µm	<b>MSB6-1/2-FRC5:J1M1</b> ★	<b>530244</b>

Filter regulators/lubricators > MS series >

Service units MSB4/MSB6-FRC, MS series ★

Accessories

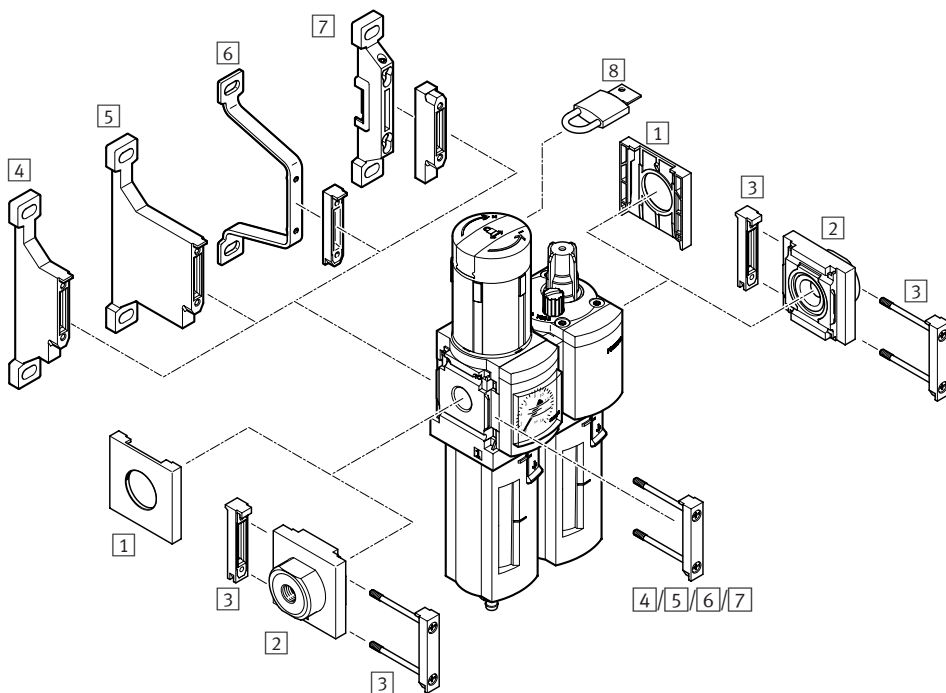

- 1 Cover cap MS4/6-END  
→ [ms4-end](#)
- 2 Connecting plate kit MS4/6-AG...  
→ 156
- 3 Module connector MS4/6-MV  
→ 144
- 4 Mounting bracket MS4/6-WP  
→ 144
- 5 Mounting bracket MS4/6-WPB  
→ 144
- 6 Mounting bracket MS4/6-WPE  
→ [ms4-wpe](#)
- 7 Mounting bracket MS4/6-WPM  
→ 144
- 8 Padlock LRVS-D → [lrvs](#)

3 Module connector MS4/6-MV		
Size	Type	Part no.
4	MS4-MV	★ 532798
6	MS6-MV	★ 532799

5 Mounting bracket MS4/6-WPB		
Size	Type	Part no.
For wall mounting		
4	MS4-WPB	★ 526063
6	MS6-WPB	★ 526074

7 Mounting bracket MS4/6-WPM		
Size	Type	Part no.
For wall mounting		
4	MS4-WPM-D	★ 526060
6	MS6-WPM-D	★ 526073

4 Mounting bracket MS4/6-WP		
Size	Type	Part no.
For wall mounting		
4	MS4-WP	★ 532184
6	MS6-WP	★ 532195



- Filter and pressure regulator in a single unit
- Good regulation characteristics with minimal hysteresis and primary pressure compensation
- Good particle and condensate separation
- Flow rate 850 ... 7200 l/min
- Operating pressure 0.8 ... 20 bar
- Grade of filtration 5 µm, 40 µm
- Manual rotary, fully automatic condensate drain

## Order code

001 002 003 004 005 006 007 008 009 010  
 MS [ ] - LFR - [ ] - [ ] - [ ] - [ ] - [ ] - AS - [ ]

Legend: [ ] Mandatory entry [ ] Optional entry

001	Type
MS	Standard service unit
002	Size
4	Grid dimension 40 mm
6	Grid dimension 62 mm
003	Service function
LFR	Filter regulator
004	Pneumatic connection
1/4	Female thread G1/4
1/2	Female thread G1/2
005	Pressure regulation range
D6	Pressure regulation range 0.3 ... 7 bar
D7	Pressure regulation range 0.5 ... 12 bar

006	Grade of filtration
C	5 µm
E	40 µm
007	Bowl guard
R	Plastic bowl guard
U	Integrated as metal bowl guard
008	Condensate drain
M	Manual rotary
V	Fully automatic
009	Lockable
AS	Rotary knob with detent, can be locked using accessories
010	Flow direction
-	From left to right

## Product options

- Size 2, 9, 12
- Pneumatic connection
- Pressure regulation range
- Condensate drain
- Pressure gauge alternatives
- Alternative pressure gauge scale
- Secondary venting
- Rotary knob
- Lockable
- Type of mounting
- EU certification
- UL certification
- Flow direction

Configurable product

This product and all its product options can be ordered online via the configurator:

→ [www.festo.com/catalogue/ms-lfr](http://www.festo.com/catalogue/ms-lfr)

Filter regulators > MS series >

Filter regulators MS4/MS6-LFR, MS series ★

Ordering – Basic design

			006 Grade of filtration 5 µm		006 Grade of filtration 40 µm		
002 Size	004 Pneumatic connection	008 Condensate drain	Type	Part no.	Type	Part no.	
Pressure regulation range 0.3 ... 7 bar, integrated pressure gauge, display unit [bar], standard rotary knob with detent, can be locked using accessories, plastic bowl guard							
4	G1/4		Manual rotary	MS4-LFR-1/4-D6-CRM-AS ★	529144	MS4-LFR-1/4-D6-ERM-AS ★	529148
			Fully automatic	MS4-LFR-1/4-D6-CRV-AS ★	529146	MS4-LFR-1/4-D6-ERV-AS ★	529150
6	G1/2		Manual rotary	MS6-LFR-1/2-D6-CRM-AS ★	529176	MS6-LFR-1/2-D6-ERM-AS ★	529180
			Fully automatic	MS6-LFR-1/2-D6-CRV-AS ★	529178	MS6-LFR-1/2-D6-ERV-AS ★	529182
Pressure regulation range 0.5 ... 12 bar, integrated pressure gauge, display unit [bar], standard rotary knob with detent, can be locked using accessories, plastic bowl guard							
4	G1/4		Manual rotary	MS4-LFR-1/4-D7-CRM-AS ★	529152	MS4-LFR-1/4-D7-ERM-AS ★	529156
			Fully automatic	MS4-LFR-1/4-D7-CRV-AS ★	529154	MS4-LFR-1/4-D7-ERV-AS ★	529158
6	G1/2		Manual rotary	MS6-LFR-1/2-D7-CRM-AS ★	529184	MS6-LFR-1/2-D7-ERM-AS ★	529188
			Fully automatic	MS6-LFR-1/2-D7-CRV-AS ★	529186	MS6-LFR-1/2-D7-ERV-AS ★	529190
Pressure regulation range 0.5 ... 12 bar, integrated pressure gauge, display unit [bar], standard rotary knob with detent, can be locked using accessories, integrated as metal bowl guard							
4	G1/4		Manual rotary			MS4-LFR-1/4-D7-EUM-AS ★	535724
			Fully automatic	MS4-LFR-1/4-D7-CUV-AS ★	535720	MS4-LFR-1/4-D7-EUV-AS ★	535722
6	G1/2		Manual rotary	MS6-LFR-1/2-D7-CUM-AS ★	530338	MS6-LFR-1/2-D7-EUM-AS ★	529192
			Fully automatic	MS6-LFR-1/2-D7-CUV-AS ★	530340	MS6-LFR-1/2-D7-EUV-AS ★	529194

Accessories

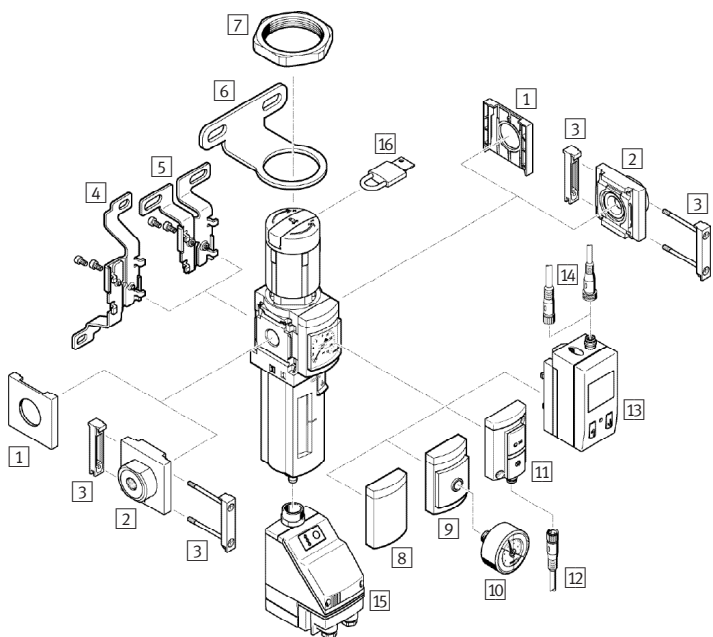

- 1 Cover cap MS-END → [ms4-end](#)
  - 2 Connecting plate kit MS4/6-AG... → 156
  - 3 Module connector MS-MV → 146
  - 4 Mounting bracket MS-WB → 146
  - 5 Mounting bracket MS-WBM → [ms4-wbm](#)
  - 6 Mounting bracket MS-WR → 146
  - 7 Hex nut MS-WRS → [ms4-wrs](#)
  - 8 Cover plate VS → [ms4-lfr](#)
  - 9 Adapter plate for EN pressure gauge → [ms4-lfr](#)
  - 10 Pressure gauge MA → [ms4-lfr](#)
  - 11 Pressure sensor without display → [ms4-lfr](#)
  - 12 Connecting cable NEBU-M8...-LE3 → 183
  - 13 Pressure sensor with display → [ms4-lfr](#)
  - 14 Connecting cable NEBU-M8...-LE3/NEBU-M12...-LE4 → 183
  - 15 Fully automatic condensate drain, electrically actuated → [ms4-lfr](#)
  - 16 Padlock LRVS-D → [lrvs](#)
- Mounting bracket MS-WP → 146  
Mounting bracket MS-WPB → 146  
Mounting bracket MS-WPM → 146

3 Module connector MS-MV		
Size	Type	Part no.
4	MS4-MV	★ 532798
6	MS6-MV	★ 532799

Module connector MS-MVM		
Size	Type	Part no.
For installation of modules with regulating knob pointing downwards		
4	MS4-MVM	★ 532800
6	MS6-MVM	★ 532801

4 Mounting bracket MS-WB		
Size	Type	Part no.
For wall mounting		
4	MS4-WB	★ 532185
6	MS6-WB	★ 532196

6 Mounting bracket MS-WR		
Size	Type	Part no.
For wall mounting		
4	MS4-WR	★ 526064
6	MS6-WR	★ 526075

Mounting bracket MS-WP		
Size	Type	Part no.
For wall mounting		
4	MS4-WP	★ 532184
6	MS6-WP	★ 532195

Mounting bracket MS-WPB		
Size	Type	Part no.
For wall mounting		
4	MS4-WPB	★ 526063
6	MS6-WPB	★ 526074

Mounting bracket MS-WPM		
Size	Type	Part no.
For wall mounting		
4	MS4-WPM-D	★ 526060
6	MS6-WPM-D	★ 526073



- Maintains a constant working pressure independent of pressure fluctuations and air consumption
- High flow rate with minimal pressure drop
- Connection G1/4, G1/2
- Flow rate 1000 ... 7500 l/min
- Operating pressure 0.8 ... 20 bar
- Selected types in accordance with ATEX directive for potentially explosive atmospheres  
→ [www.festo.com/ex](http://www.festo.com/ex)

## Order code

001 002 003 004 005 006 007  
MS - LR - AS -

Legend:  Mandatory entry  Optional entry

001	Type
MS	Standard service unit
002	Size
4	Grid dimension 40 mm
6	Grid dimension 62 mm
003	Service function
LR	Pressure regulator
004	Pneumatic connection
1/4	Female thread G1/4
1/2	Female thread G1/2

005	Pressure regulation range
D5	0.3 ... 4 bar, manually actuated
D6	0.3 ... 7 bar, manually actuated
D7	0.5 ... 12 bar, manually actuated
006	Lockable
AS	Standard rotary knob with detent, can be locked using accessories
007	Flow direction
-	From left to right

## Product options

- Size 9, 12
- Pneumatic connection
- Connecting plates
- Pressure regulation range/operation
- Pressure gauge alternatives
- Alternative pressure gauge scale
- Secondary venting
- Lockable
- Type of mounting
- EU certification
- UL certification
- Alternative flow direction

 Configurable product

This product and all its product options can be ordered online via the configurator:

→ [www.festo.com/catalogue/ms-lr](http://www.festo.com/catalogue/ms-lr)

## Ordering – Basic design

		005 Pressure regulation range 0.3 ... 4 bar		005 Pressure regulation range 0.3 ... 7 bar		005 Pressure regulation range 0.5 ... 12 bar	
002 Size	004 Pneumatic connection	Type	Part no.	Type	Part no.	Type	Part no.
Integrated pressure gauge, display unit [bar], standard rotary knob with detent, can be locked using accessories							
4	G1/4	MS4-LR-1/4-D5-AS	★ 529415	MS4-LR-1/4-D6-AS	★ 529417	MS4-LR-1/4-D7-AS	★ 529419
6	G1/2	MS6-LR-1/2-D5-AS	★ 529989	MS6-LR-1/2-D6-AS	★ 529991	MS6-LR-1/2-D7-AS	★ 529993

## Accessories

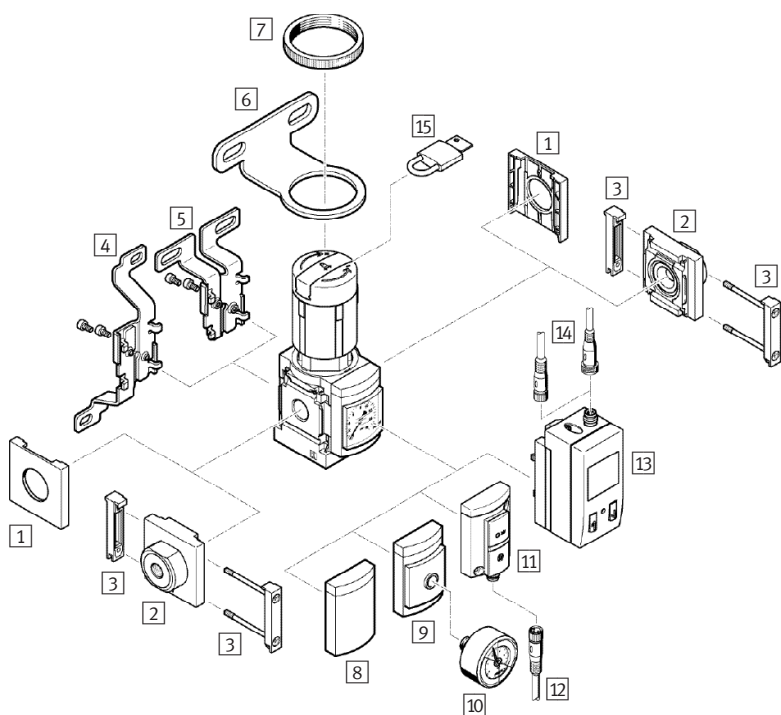

- 1 Cover cap MS-END → [ms4-end](#)
- 2 Connecting plate kit MS4/6-AG... → 156
- 3 Module connector MS-MV → 146
- 4 Mounting bracket MS-WB → 146
- 5 Mounting bracket MS-WBM → [ms4-wbm](#)
- 6 Mounting bracket MS-WR → 146
- 7 Knurled nut (included in the scope of delivery)  
MS-LR → [ms4-lr](#)
- 8 Cover plate VS → [ms4-lr](#)
- 9 Adapter plate for EN pressure gauge → [ms4-lr](#)
- 10 Pressure gauge MA → [ma](#)
- 11 Pressure sensor without display → [ms4-lr](#)
- 12 Connecting cable NEBU-M8...-LE3 → 183
- 13 Pressure sensor with display → [ms4-lr](#)
- 14 Connecting cable NEBU-M8...-LE3/NEBU-M12...-LE4 → 183
- 15 Padlock LRVS-D → [lrvs](#)

Mounting bracket  
MS-WP, MS-WPB, MS-WPM → 146



- For pressurising and exhausting pneumatic systems
- Connection G1/4, G1/2
- Flow rate 1000 ... 8700 l/min
- Operating pressure 0 ... 18 bar
- Selected types in accordance with ATEX directive for potentially explosive atmospheres  
→ [www.festo.com/ex](http://www.festo.com/ex)

### Order code – Basic design

001 002 003 004 005 006  
MS  -  -  -  -  -

Legend:  Mandatory entry  Optional entry

001	Type
MS	Standard service unit
002	Size
4	Grid dimension 40 mm
6	Grid dimension 62 mm
003	Service function
EM1	Manually operated on/off valve
EE	Solenoid actuated on/off valve
004	Pneumatic connection
1/4	Female thread G1/4
1/2	Female thread G1/2

005	Supply voltage
-	Without (manually operated on/off valve)
10V24	Supply voltage 24 V DC
006	Silencers
-	Without silencer
S	With silencer

### Product options

- Additional connection sizes
- Silencer
- Connecting plates
- Pressure gauge/pressure gauge alternatives
- Alternative pressure gauge scale
- Supply voltage
- Type of mounting
- Valve function
- EU certification
- UL certification
- Flow direction

#### Configurable product

This product and all its product options can be ordered online via the configurator:

→ [www.festo.com/catalogue/ms-e](http://www.festo.com/catalogue/ms-e)

### Ordering – Basic design

		006 Without silencer		006 With silencer	
002 Size	004 Pneumatic connection	Type	Part no.	Type	Part no.
Manually operated on/off valve					
005 Without supply voltage					
4	G1/4	MS4-EM1-1/4	★ 541258	MS4-EM1-1/4-S	★ 541259
6	G1/2	MS6-EM1-1/2	★ 541267	MS6-EM1-1/2-S	★ 541268
Solenoid actuated on/off valve					
005 Supply voltage 24 V DC					
4	G1/4	MS4-EE-1/4-10V24	★ 542578	MS4-EE-1/4-10V24-S	★ 542598
6	G1/2	MS6-EE-1/2-10V24	★ 542582	MS6-EE-1/2-10V24-S	★ 542602

On/off valves and soft-start valves > MS series > Manually/solenoid actuated on/off valves >

On/off valves MS4/MS6-EM1, MS4/MS6-EE, MS series ★

## Accessories

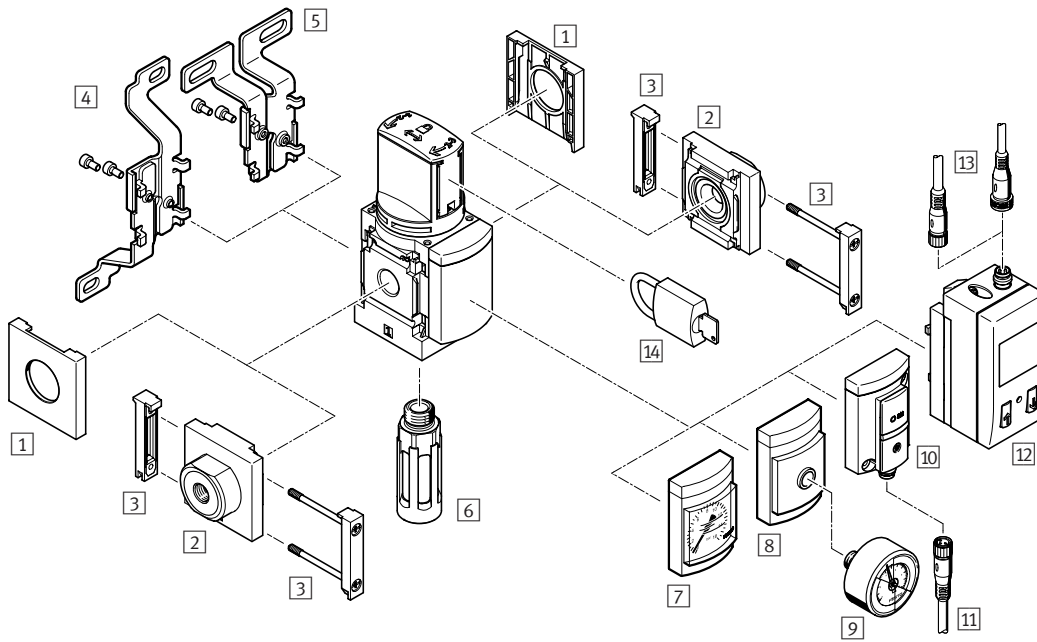

- 1 Cover cap MS-END → [ms4-end](#)
- 2 Connecting plate kit MS4/6-AG... → 156
- 3 Module connector MS-MV → 146
- 4 Mounting bracket MS-WB → 146
- 5 Mounting bracket MS-WBM → [ms4-wbm](#)
- 6 Silencer U-B → 192
- 7 MS pressure gauge → [ms4-em1](#)
- 8 Adapter plate for EN pressure gauge → [ms4-em1](#)
- 9 Pressure gauge MA → [ma](#)
- 10 Pressure sensor without display → [ms4-em1](#)
- 11 Connecting cable NEBU-M8...-LE3 → 183
- 12 Pressure sensor with display → [ms4-em1](#)
- 13 Connecting cable NEBU-M8...-LE3/NEBU-M12...-LE4 → 183
- 14 Padlock LRVS-D → [lrvs](#)

Mounting bracket  
MS-WP, MS-WPB, MS-WPM → 146



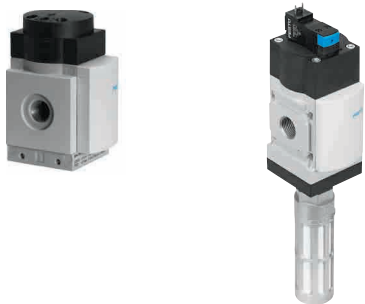

- For slowly pressurising and exhausting pneumatic installations (for use with on/off valves EM1 and EE)
- Connection G1/4, G1/2
- Flow rate 1000 ... 6450 l/min
- Operating pressure 4 ... 18 bar
- Selected types in accordance with ATEX directive for potentially explosive atmospheres  
→ [www.festo.com/ex](http://www.festo.com/ex)

## Order code – Basic design

001	002	003	004	005	006
MS					

Legend:  Mandatory entry  Optional entry

001	Type
MS	Standard service unit
002	Size
4	Grid dimension 40 mm
6	Grid dimension 62 mm
003	Service function
DL	Pneumatically actuated soft-start valve
004	Pneumatic connection
1/4	Female thread G1/4
1/2	Female thread G1/2

005	Pressure gauge/adapter
–	None
006	Type of mounting
–	Without mounting bracket

## Product options

- MS-SV-C: Soft start/quick exhaust valve
- For the gradual pressurisation and quick exhausting of system components (single channel)
  - Additional connection sizes
  - Connecting plates
  - Supply voltage
  - Pressure gauge/pressure gauge alternatives
  - Alternative pressure gauge scale
  - Type of mounting
  - Tamper protection
  - EU certification
  - UL certification
  - Flow direction

Configurable product

This product and all its product options can be ordered online via the configurator:

→ [www.festo.com/catalogue/ms-dl](http://www.festo.com/catalogue/ms-dl)

## Ordering – Basic design

002 Size	004 Pneumatic connection	Type	Part no.
Pneumatically actuated soft-start valve			
4	G1/4	MS4-DL-1/4	★ 529531
6	G1/2	MS6-DL-1/2	★ 529817

On/off and soft-start valves > MS series >

Soft-start valves MS4/MS6-DL, MS series ★

Accessories

MS4/MS6-DL

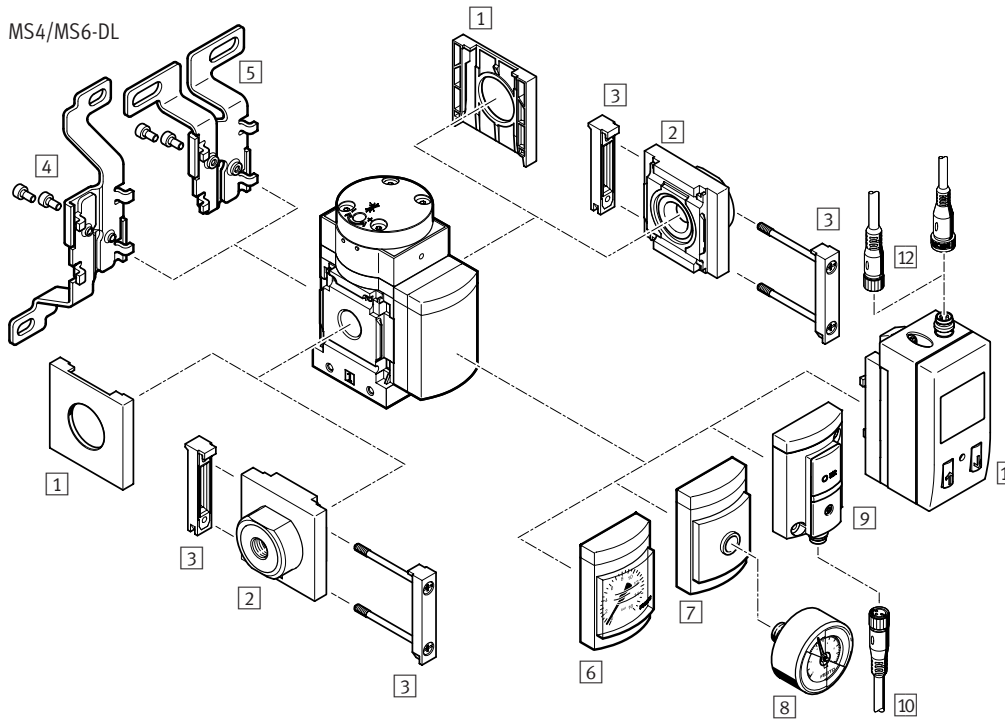

- 1 Cover cap MS-END → [ms4-end](#)
- 2 Connecting plate kit MS4/6-AG... → 156
- 3 Module connector MS-MV → 146
- 4 Mounting bracket MS-WB → 146
- 5 Mounting bracket MS-WBM → [ms4-wbm](#)
- 6 MS pressure gauge → [ms4-dl](#)
- 7 Adapter plate for EN pressure gauge → [ms4-dl](#)
- 8 Pressure gauge MA → [ma](#)
- 9 Pressure sensor without display → [ms4-dl](#)
- 10 Connecting cable NEBU-M8...-LE3 → 183
- 11 Pressure sensor with display → [ms4-dl](#)
- 12 Connecting cable NEBU-M8...-LE3/NEBU-M12...-LE4 → 183

Mounting bracket  
MS-WP, MS-WPB, MS-WPM → 146



- Can be used as an intermediate distributor for varying air qualities
- Outlet at top and bottom
- Flow rate 1200 ... 14700 l/min
- Operating pressure 0 ... 20 bar

## Order code – Basic design

001 002 003 004 005  
MS  - FRM -  -

Legend:  Mandatory entry  Optional entry

001	Series
MS	Standard service unit
002	Size
4	Grid dimension 40 mm
6	Grid dimension 62 mm
003	Service function
FRM	Branching module

004	Pneumatic connection
1/4	Female thread G1/4
1/2	Female thread G1/2
005	Non-return function/pressure switch
-	Standard

## Product options

- Additional connection sizes
- Connecting plates
- Pressure gauge/pressure gauge alternatives
- Alternative pressure gauge scale
- Pressure switch
- Type of mounting
- EU certification
- UL certification
- Flow direction



Configurable product

This product and all its product options can be ordered online via the configurator:

→ [www.festo.com/catalogue/ms-frm](http://www.festo.com/catalogue/ms-frm)

## Ordering – Basic design

002 Size	004 Pneumatic connection	Type	Part no.
6	G1/4	MS6-FRM-1/4	★ 529857
6	G1/2	MS6-FRM-1/2	★ 529853

## Accessories

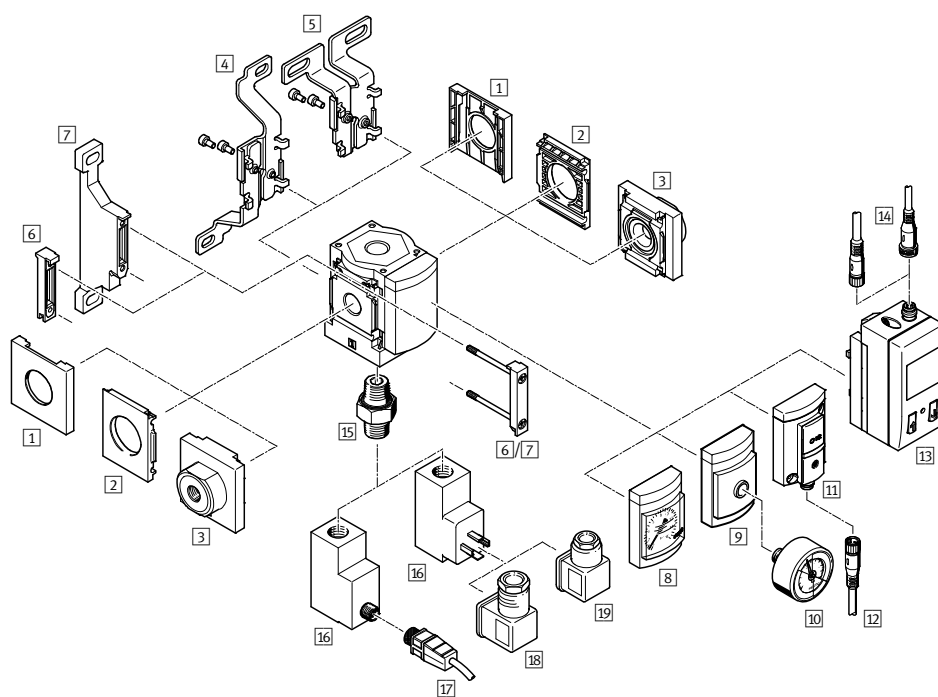

- 1 Cover cap MS4-END → [ms4-end](#)
- 2 Mounting plate MS4/6-AEND → [ms4-aend](#)
- 3 Connecting plate kit MS4/6-AG... → 156
- 4 Mounting bracket MS-WB → 146
- 5 Mounting bracket MS4-WBM → [ms4-wbm](#)
- 6 Module connector MS-MV → 146
- 7 Mounting bracket MS-WP → 146
- 8 MS pressure gauge → [ms-frm](#)
- 9 Adapter plate for EN pressure gauge → [ms-frm](#)
- 10 Pressure gauge MA → [ma](#)
- 11 Pressure sensor without display → [ms-frm](#)
- 12 Connecting cable NEBU-M8...-LE3 → 183
- 13 Pressure sensor with display → [ms-frm](#)
- 14 Connecting cable NEBU-M8...-LE3/NEBU-M12...-LE4 → 183
- 15 Double nipple ESK → [ms-frm](#)
- 16 Pressure switch PEV → [ms-frm](#)
- 17 Connecting cable NEBU-M12...-LE4 → 183
- 18 Angled socket PEV-1/4-WD-LED → [ms-frm](#)
- 19 Plug socket MSSD-C-4P → [ms-frm](#)



- Can be used as an intermediate distributor for varying air qualities
- Outlet at top and bottom
- Flow rate 2900 ... 14600 l/min
- Operating pressure 0 ... 20 bar

## Order code

001 002 003  
MS  - FRM - FRZ

Legend:  Mandatory entry

001	Series
MS	Standard service unit
002	Size
4	Grid dimension 40 mm
6	Grid dimension 62 mm
003	Service function
FRM-FRZ	Distributor block

## Ordering

002 Size	Pneumatic connection 3, 4	Type	Part no.
4	G1/4	MS4-FRM-FRZ ★	549336
6	G1/2	MS6-FRM-FRZ ★	549337

Accessories for compressed air preparation >

## Connecting plates MS4/MS6-AG... ★

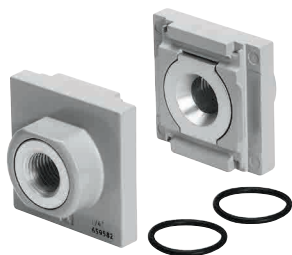

- Adapter for pneumatic connection
- MS6-AGE for implementing threaded connection G $\frac{3}{4}$

### Ordering

002 Size	Pneumatic connection	Type	Part no.
4	G1/4	MS4-AGB	★ 526069
4	G3/8	MS4-AGC	★ 526070
6	G1/2	MS6-AGD	★ 526082
6	G3/4	MS6-AGE	★ 526083



# 11

## Pneumatic connection technology

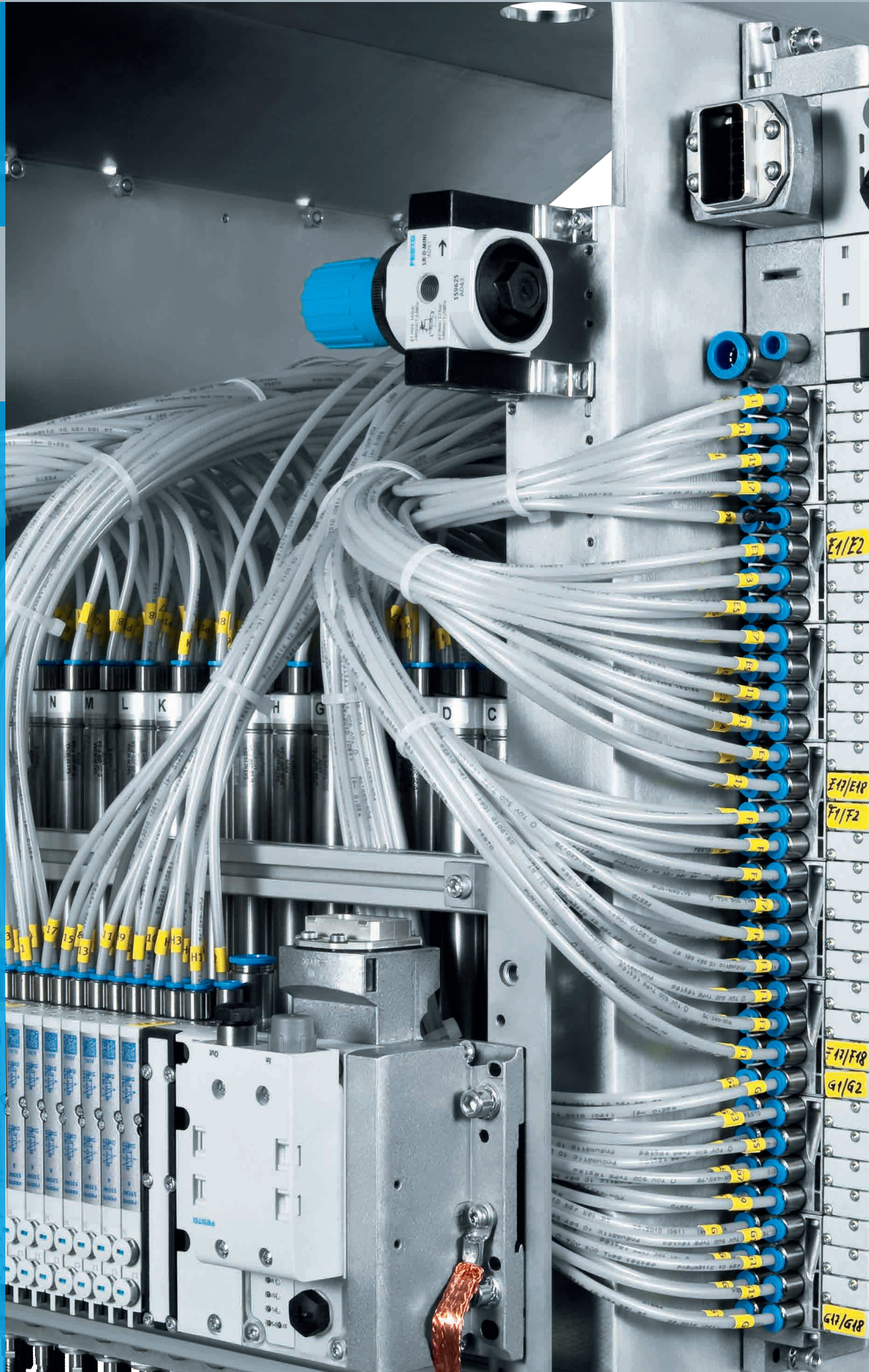



# Highlights



Plastic tubing

## PUN-H

- + Wide choice of variants
- + PUN-H: high resistance to microbes and hydrolysis and approved for use in the food industry
- + PUN-H-T: Translucent black, blue

→ 164



Push-in fittings

## QSM, QS

- + QSM: mini series for maximum component density in small installation spaces
- + QS: standard series for maximum flexibility in standard applications

→ 166, 168

# Contents



Product overview	160
Overview: Tubing/fitting combinations	163
Plastic tubing PUN-H, hydrolysis-resistant ★	164
Push-in fittings QSM, mini series ★	166
Push-in fittings QS, standard series ★	168
Blanking plugs B-... ★	173
Quick coupling sockets/plugs NPHS-D/NPHS-S, KD ★	174

Product overview

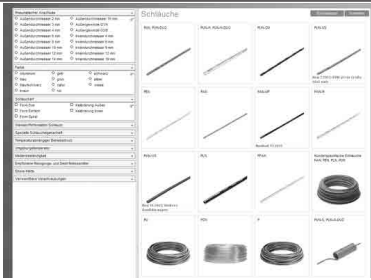
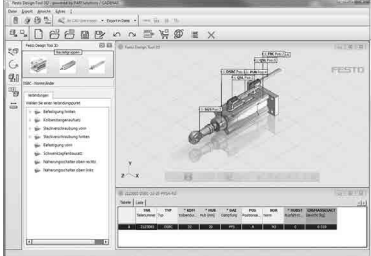

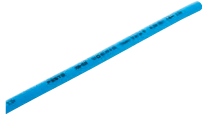

Software-Tools

<p><b>Product Finder for tubing</b></p> 	<p>Simply enter parameters such as working pressure, chemicals and required resistance to cleaning agents and have the program calculate the right tubing for your application.</p> <p>This tool can be found</p> <ul style="list-style-type: none"> <li>on our website at <a href="http://www.festo.com/catalogue">www.festo.com/catalogue</a> by clicking on the blue button "Product Finder".</li> </ul>
<p><b>Festo Design Tool 3D</b></p> 	<p>The Festo Design Tool 3D is a 3D product configurator for generating specific CAD product combinations from Festo.</p> <p>The configurator makes your search for the right accessory easier, more reliable and faster.</p> <p>You can then order the module that has been created as a single order item, either completely pre-assembled or as individual parts in a single box.</p> <p>This considerably reduces your bill of materials, and downstream processes such as product ordering, order picking and assembly are significantly simplified.</p> <p>All ordering options are available in the following countries: AT, BE, CH, CZ, DE, DK, ES, EST, FI, FR, GB, GR, HU, IE, IT, NL, NO, PL, PT, RU, SE, SI, SK, TR, ZA.</p> <p>This tool can be found</p> <ul style="list-style-type: none"> <li>via the address: <a href="http://www.festo.com/fdt-3d-online">www.festo.com/fdt-3d-online</a> in the countries listed above.</li> </ul>

O.D. tubing



	 <b>Plastic tubing PUN-H, PUN-H-DUO</b>	 <b>Plastic tubing PUN, PUN-DUO</b>	 <b>Plastic tubing PEN</b>	 <b>Plastic tubing PLN</b>
<b>O.D.</b>	2 ... 16 mm	3 ... 16 mm	4 ... 16 mm	4 ... 16 mm
<b>I.D.</b>	1.2 ... 11 mm	2 ... 11 mm	2.7 ... 10.8 mm	2.9 ... 12 mm
<b>Temperature-dependent operating pressure</b>	-0.95 ... 10 bar	-0.95 ... 30 bar	-0.95 ... 10 bar	-0.95 ... 14 bar
<b>Ambient temperature</b>	-35 ... 60°C	-35 ... 60°C	-30 ... 60°C	-30 ... 80°C
<b>Description</b>	<ul style="list-style-type: none"> <li>• Polyurethane</li> <li>• High resistance to microbes and hydrolysis</li> <li>• Food-safe, see <a href="http://www.festo.com/sp/pun-h">www.festo.com/sp/pun-h</a> &gt; "Certificates" tab</li> <li>• Suitable for energy chains</li> <li>• Also available as DUO tubing</li> <li>• Operating media: compressed air, vacuum, water</li> </ul>	<ul style="list-style-type: none"> <li>• Polyurethane</li> <li>• High resistance to stress cracks</li> <li>• Suitable for energy chains</li> <li>• Also available as DUO tubing</li> <li>• Operating media: compressed air, vacuum</li> </ul>	<ul style="list-style-type: none"> <li>• Polyethylene</li> <li>• High resistance to chemicals and very high resistance to hydrolysis</li> <li>• Resistant to most cleaning agents and lubricants</li> <li>• Suitable for energy chains</li> <li>• Operating media: compressed air, vacuum, water</li> </ul>	<ul style="list-style-type: none"> <li>• Polyethylene</li> <li>• High resistance to chemicals, microbes and hydrolysis</li> <li>• Food-safe, see <a href="http://www.festo.com/sp/pln">www.festo.com/sp/pln</a> &gt; "Certificates" tab</li> <li>• Resistant to most cleaning agents and lubricants</li> <li>• Operating media: compressed air, vacuum, water</li> </ul>
<b>→ Page/online</b>	164	<a href="#">pun</a>	<a href="#">pen</a>	<a href="#">pln</a>

## Push-in fittings



	 Push-in fittings, mini series QSM, QSMC, QSMF, QSML, QSMP, QSMS, QSMT, QSMX, QSMY	 Push-in fittings, standard series QS, QSF, QSS, QSC, QSH, QSL, QST, QSW, QSX, QSY	 Push-in fittings NPQH	 Push-in fittings/connectors, metal, standard series NPQM
<b>Pneumatic connection 1</b>	Male thread M8x1.25, male thread G1/8, M3, M5, M6, M6x0.75, M7, M8x0.75, R1/8, female thread M3, M5, push-in sleeve QS-2, QS-3, QS-4, QS-6, for tubing O.D. 2 mm, 3 mm, 4 mm, 6 mm	Male thread G1/2, G1/4, G1/8, G3/4, G3/8, M5, R1/2, R1/4, R1/8, R3/8, female thread G1/2, G1/4, G1/8, G3/8, push-in sleeve QS-10, QS-12, QS-16, QS-4, QS-6, QS-8, for tubing O.D. 10 mm, 12 mm, 16 mm, 4 mm, 6 mm, 8 mm	Male thread G1/2, G1/4, G1/8, G3/8, M5, M7, female thread G1/4, G1/8, push-in sleeve QS-10, QS-12, QS-14, QS-4, QS-6, QS-8, for tubing O.D. 10 mm, 12 mm, 14 mm, 4 mm, 6 mm, 8 mm	Push-in sleeve QS-10, QS-12, QS-14, QS-4, QS-6, QS-8, for tubing O.D. 10 mm, 12 mm, 14 mm, 4 mm, 6 mm, 8 mm, G1/2, G1/4, G1/8, G3/8, M5, M7
<b>Pneumatic connection 2</b>	For tubing O.D. 2 mm, 3 mm, 4 mm, 6 mm	Female thread G1/2, G1/4, G1/8, G3/8, push-in sleeve QS-10, QS-12, QS-16, QS-4, QS-6, QS-8, for tubing O.D. 10 mm, 12 mm, 16 mm, 22 mm, 4 mm, 6 mm, 8 mm	Push-in sleeve QS-10, QS-12, QS-14, QS-4, QS-6, QS-8, for tubing O.D. 10 mm, 12 mm, 14 mm, 4 mm, 6 mm, 8 mm	For tubing O.D. 10 mm, 12 mm, 14 mm, 3 mm, 4 mm, 6 mm, 8 mm
<b>Operating pressure for entire temperature range</b>	-0.95 ... 6 bar	-0.95 ... 14 bar	-0.95 ... 20 bar	-0.95 ... 16 bar
<b>Ambient temperature</b>	-10 ... 80°C	-20 ... 80°C	0 ... 150°C	-20 ... 70°C
<b>Description</b>	<ul style="list-style-type: none"> <li>• Mini series</li> <li>• Compact for maximum component density in confined installation spaces</li> <li>• PBT and nickel-plated brass</li> <li>• Operating media: compressed air, vacuum</li> </ul>	<ul style="list-style-type: none"> <li>• Standard series</li> <li>• Wide range of variants: large selection for maximum flexibility in standard applications</li> <li>• PBT and nickel-plated brass</li> <li>• Operating media: compressed air, vacuum, (water)</li> </ul>	<ul style="list-style-type: none"> <li>• Solid-metal brass, chemically nickel-plated</li> <li>• High corrosion and chemical resistance</li> <li>• Highly resistant to temperatures and pressure</li> <li>• Food-safe, see <a href="http://www.festo.com/sp/npqh">www.festo.com/sp/npqh</a> &gt; "Certificates" tab</li> <li>• Operating media: compressed air, vacuum, water</li> </ul>	<ul style="list-style-type: none"> <li>• Solid-metal brass, nickel-plated</li> <li>• Attractively priced metal push-in fitting</li> <li>• Sturdy</li> <li>• Operating media: compressed air, vacuum</li> </ul>
<b>→ Page/online</b>	<b>166</b>	<b>168</b>	<b>npqh</b>	<b>npqm</b>

Product overview

Threaded fittings

	 <b>Threaded fittings NPFC</b>	 <b>Blanking plug B</b>
<b>Pneumatic connection 1</b>	G1, G1/2, G1/4, G1/8, G3/4, G3/8, M3, M5, M7, R1, R1/2, R1/4, R1/8, R3/4, R3/8	Male thread G1, G1/2, G1/4, G1/8, G3/4, G3/8, M3, M5, M7
<b>Pneumatic connection 2</b>	G1, G1/2, G1/4, G1/8, G3/4, G3/8, M3, M5, R1, R1/2, R1/4, R1/8, R3/4, R3/8	
<b>Operating pressure</b>	-0.95 ... 50 bar	
<b>Ambient temperature</b>	-20 ... 150°C	
<b>Description</b>	<ul style="list-style-type: none"> <li>• Nickel-plated brass</li> <li>• Sleeve</li> <li>• Extension</li> <li>• Double nipple</li> <li>• Reducing nipple</li> <li>• L-, T-, Y- or X-fitting</li> <li>• Operating media: compressed air, vacuum</li> </ul>	<ul style="list-style-type: none"> <li>• Aluminium, stainless steel</li> <li>• With sealing ring</li> </ul>
<b>→ Page/online</b>	<a href="#">npfc</a>	<b>173</b>

Couplings

	 <b>Quick coupling sockets, quick coupling plugs NPHS-D6, NPHS-S6</b>	 <b>Quick coupling sockets, quick coupling plugs KD, KD1, KD2, KD3, KD4, KS, KS1, KS2, KS3, KS4</b>
<b>Pneumatic connection 1</b>	For plug-in nipple I.D. 9 mm, male thread G1/2, G1/4, G1/8, G3/8, female thread G1/2, G1/4, G3/8	N-6, N-9, male thread G1/2, G1/4, G1/8, G3/8, M3, M5, female thread G1/2, G1/4, G1/8, G3/8, M5, CK-3, CK-4, CK-6, CK-9, CN-2
<b>Standard nominal flow rate</b>	875 ... 2083 l/min	44 ... 1350 l/min
<b>Ambient temperature</b>	-20 ... 80°C	-10 ... 80°C
<b>Description</b>	<ul style="list-style-type: none"> <li>• Safety coupling</li> <li>• Shut-off at one end</li> <li>• Releasing sleeve made of metal or polymer</li> <li>• Exhaust the air on the connector side without releasing the coupling</li> <li>• Combination of coupling and hand slide valve</li> <li>• Can be used as an on/off valve</li> </ul>	<ul style="list-style-type: none"> <li>• Quick connection coupling for standard applications without safety function</li> <li>• Shut off at one or both ends</li> <li>• With male or female thread or with barbed fitting or quick connector</li> <li>• Nickel-plated brass, PP</li> <li>• Operating media: compressed air, vacuum</li> </ul>
<b>→ Page/online</b>	<b>174</b>	<b>174</b>

## Everything from a single source – for the ideal combination

Our range of tubing and fittings covers every conceivable task. Regardless of whether your selection is determined by standard requirements or extreme conditions such as heat, welding spatter, high pH values or resistance to hydrolysis – at Festo you'll always find the right tubing/fitting combination.

### Tubing

Material	Polyurethane (PU)					Polyethylene (PE)		Polyamide (PA)				Perfluoroalkoxy alkane
	Designation	PUN/PUN-DUO → pun	PUN-H <sup>3)</sup> ★/ PUN-H-DUO → 164	PUN-CM → pun	PUN-V0 → pun-v0	PUN-V0-C → pun-v0	PEN → pen	PLN → pln	PAN → pan	PAN-R → pan-r	PAN-V0 → pan-v0	PAN-MF → pan-mf
Operating medium	Compressed air, vacuum	Compressed air, vacuum, water <sup>1)</sup>	Compressed air, vacuum	Compressed air, vacuum, water <sup>1)</sup>	Compressed air, vacuum, water <sup>1)</sup>	Compressed air, vacuum, water <sup>1)</sup>	Compressed air, vacuum, water <sup>1)</sup>	Compressed air, vacuum	Compressed air, vacuum	Compressed air, vacuum, water <sup>1)</sup>	Compressed air, vacuum	Compressed air, vacuum, water <sup>1)</sup>
Temperature [°C]	-35 ... +60	-35 ... +60	-35 ... +60	-35 ... +60	-35 ... +60	-30 ... +60	-30 ... +80	-30 ... +80	-30 ... +80	-30 ... +90	-60 ... +100	-20 ... +150
Temperature-dependent operating pressure [bar]	-0,95 ... +10	-0,95 ... +10	-0,95 ... +10	-0,95 ... +10	-0,95 ... +10	-0,95 ... +10	-0,95 ... +14	-0,95 ... +19	-0,95 ... +35	-0,95 ... +12	-0,95 ... +31	-0,95 ... +16
Resistant to chemicals	-	+	+	+	+	++	++	+	+	+	+	+++
Food-safe <sup>2)</sup>	-	+++ FDA-listed material	-	-	-	-	+++	-	-	-	-	+++ FDA-listed material; Regulation (EC) 1935/2004
Hydrolysis-resistant	+	++	++	++	++	+++	+++	++	++	++	++	+++
Fire tested	UL 94 HB	UL 94 HB	-	UL 94 V0...V2	UL 94 V0...V2	-	-	-	-	UL 94 V0	-	UL 94 V0
Halogen-free	+++	+++	+++	+++	+++	+++	+++	+++	+++	-	+++	-
Flexibility	+++	+++	++	++	++	++	+	++	+	++	+	+
Special features	Wide choice of variants	Hydrolysis-resistant	Anti-static	Flame-retardant	Resistant to welding spatter	Suitable for use with energy chains	Weather-resistant	High load bearing capacity	Suitable for pressures up to 35 bar	Resistant to welding spatter	DIN 73378 KFZ approval	Highly resistant to chemicals

- 1) Other media on request
- 2) Suitable for use with food in accordance with supplementary material information/declaration of conformity → [www.festo.com/supportportal](http://www.festo.com/supportportal)
- 3) O.D. 3 mm and above
- +++ Highly suitable
- ++ Very suitable
- + Limited suitability (on request)
- Not suitable

### Fittings

Material	Polymer				Metal					
	Designation	NPKA → npka	NPQP → npqp	QS, QSM ★ → 168, 166	QS-V0 → qs-v0	NPQM → npqm	NPQH → npqh	NPFC → npfc	NPCK → npck	CRQS → crqs
Operating medium	Compressed air, vacuum, water <sup>1)</sup>	Compressed air, vacuum	Compressed air, vacuum, water <sup>1)</sup>	Compressed air, vacuum, water <sup>1)</sup>	Compressed air, vacuum, water <sup>1)</sup>	Compressed air, vacuum, water <sup>1)</sup>	Compressed air, vacuum <sup>1)</sup>	Compressed air, vacuum, water <sup>1)</sup>	Compressed air, vacuum, water <sup>1)</sup>	Compressed air, vacuum, water <sup>1)</sup>
Temperature [°C]	-10 ... +60	-20 ... +60	-10 ... +80	0 ... +60	-20 ... +70	0 ... +150	-20 ... +150	-20 ... +120	-15 ... +120	
Temperature-dependent operating pressure [bar]	-0,95 ... +10	-0,95 ... +10	-0,95 ... +14	-0,95 ... +10	-0,95 ... +16	-0,95 ... +20	-0,95 ... +50	-0,95 ... +12	-0,95 ... +10	
Housing material	POM and PA66	PP	PBT and nickel-plated brass	PBT	Nickel-plated brass	Nickel-plated brass	Nickel-plated brass	Stainless steel	Stainless steel	
Thread	G thread	R thread	M, G and R thread	G and R threads	M and G thread	M and G thread	M, G and R thread	M and G thread	M and R thread	
Resistant to chemicals	++	+++	+	+	+	++	+	+++	+++	
Food-safe <sup>2)</sup>	+++ FDA-listed material	+++ FDA-listed material	-	-	-	+++ FDA-listed material	-	+++ FDA-listed material	+++	
Corrosion resistance class (CRC)	4	4	1	1	1	3	1	4	4	
Special features	Cleanroom-compatible, 100% polymer	Highly resistant to chemicals	Wide choice of variants	Resistant to welding spatter	Sturdy	Resistant to high temperatures	Economical, suitable for high pressure and temperature ranges	Clean design	Highly resistant to corrosion	

- 1) Other media on request
- 2) Suitable for use with food in accordance with supplementary material information/declaration of conformity → [www.festo.com/supportportal](http://www.festo.com/supportportal)
- +++ Highly suitable
- ++ Very suitable
- + Limited suitability (on request)
- Not suitable

Reliable selection has never been this easy: our Product Finder for tubing and fittings helps you to select a tailored combination. Get started by following these links:

- [www.festo.com/productfinder/tubing](http://www.festo.com/productfinder/tubing)
- [www.festo.com/productfinder/fittings](http://www.festo.com/productfinder/fittings)

Tubing > Standard O.D. tubing >

## Plastic tubing PUN-H, hydrolysis-resistant ★



- Extremely flexible polyurethane tubing
- Suitable for use with energy chains
- Operating media: compressed air, vacuum, water
- PUN-H-T: transparent version for greater safety, e.g. solid particles can be detected immediately
- Food-safe (see → [www.festo.com/sp/pun-h](http://www.festo.com/sp/pun-h) > "Certificates" tab) and FDA-compliant
- Individual configuration for plastic tubing

### Order code – Basic design

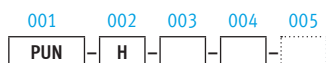

Legend:  Mandatory entry  Optional entry

001	Type
PUN	Polyurethane tubing, standard O.D.
002	Alternative material characteristic
H	Hydrolysis-resistant
003	O.D. x wall thickness [mm]
4x0,75	4.0 x 0.75
6x1	6.0 x 1.0
8x1,25	8.0 x 1.25
10x1,5	10 x 1.5
12x2	12.0 x 2.0

004	Colour
NT	Natural
SW	Black
BL	Blue
SI	Silver
TBL	Translucent blue
TSW	Translucent black
005	Packaging unit
-	50 m

### Product options

O.D.:  
2, 3, 14, 16 mm

Certifications:  
 CM Anti-static  
 H Hydrolysis-resistant  
 V0 Flame-retardant to UL 94 V0  
 R Sturdy  
 MF Automotive approval certificate  
 VOC Resistant to welding spatter

Paired tubing:  
DUO DUO tubing

Packaging units:  
100 m, 200 m, 300 m, 400 m, 500 m

Customer-specific tubing inscription

Colours:  
 GN Green  
 TGN Translucent green  
 RT Red  
 TRT Translucent red  
 WS White  
 GE Yellow  
 TGE Translucent yellow  
 BR Brown  
 BS Blue/Black

Materials:  
 PUN (Standard) polyurethane  
 PAN Polyamide  
 PFAN Perfluoralkoxy alkane  
 PEN Polyethylene

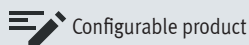

Configurable product





This product and all its product options can be ordered online via the configurator:

→ [www.festo.com/catalogue/pun](http://www.festo.com/catalogue/pun)

## Ordering – Basic design

003 O.D. [mm]	004 Colour	001 + 002 PUN-H: Polyurethane, hydrolysis-resistant		001 + 002 PUN-H-T: Polyurethane, hydrolysis-resistant, translucent	
		Type	Part no.	Type	Part no.
4	Natural	PUN-H-4X0,75-NT	★ 197376	–	
	Silver	PUN-H-4x0,75-SI	★ 558278	–	
	Blue	PUN-H-4x0,75-BL	★ 197383	PUN-H-4X0,75-TBL	★ 8048671
	Black	PUN-H-4x0,75-SW	★ 197390	PUN-H-4X0,75-TSW	★ 8048673
6	Natural	PUN-H-6X1-NT	★ 197377	–	
	Silver	PUN-H-6x1-SI	★ 558279	–	
	Blue	PUN-H-6x1-BL	★ 197384	PUN-H-6X1-TBL	★ 8048681
	Black	PUN-H-6x1-SW	★ 197391	PUN-H-6X1-TSW	★ 8048683
8	Natural	PUN-H-8X1,25-NT	★ 197378	–	
	Silver	PUN-H-8x1,25-SI	★ 558280	–	
	Blue	PUN-H-8x1,25-BL	★ 197385	PUN-H-8X1,25-TBL	★ 8048691
	Black	PUN-H-8x1,25-SW	★ 197392	PUN-H-8X1,25-TSW	★ 8048693
10	Natural	PUN-H-10X1,5-NT	★ 197379	–	
	Silver	PUN-H-10x1,5-SI	★ 558281	–	
	Blue	PUN-H-10x1,5-BL	★ 197386	PUN-H-10X1,5-TBL	★ 8048701
	Black	PUN-H-10x1,5-SW	★ 197393	PUN-H-10X1,5-TSW	★ 8048703
12	Natural	PUN-H-12X2-NT	★ 197380	–	
	Silver	PUN-H-12x2-SI	★ 558282	–	
	Blue	PUN-H-12x2-BL	★ 197387	PUN-H-12X2-TBL	★ 8048711
	Black	PUN-H-12x2-SW	★ 197394	PUN-H-12X2-TSW	★ 8048713

## Tubing/fitting combination

Fitting	Tubing	
	PUN	PUN-H
Push-in fitting QSM, mini series → 166 	–	■ For O.D. 2 mm: recommended fitting
Push-in fitting QS, standard series → 168 	■ For O.D. 3 ... 12, 16 mm: recommended fitting	■ For O.D. 3 ... 12, 16 mm: recommended fitting
Push-in fitting NPQH, metal → npqh 	■ For O.D. 4 ... 14 mm: recommended fitting	■ For O.D. 4 ... 14 mm: recommended fitting
Push-in fitting NPQM → npqm 	■ For O.D. 4 ... 14 mm	■ For O.D. 4 ... 14 mm
Quick connector CK → ck 	■ For O.D. 4 ... 8 mm	■ For O.D. 4 ... 8 mm

Fittings >

Push-in fittings QSM, mini series ★



QSM



QSML



QSMT



QSMY



QSMS

- Simple and reliable connection and release
- Compact for maximum component density in confined installation spaces

Order code

001 002 003 004 005  
 -  -

Legend:  Mandatory entry  Optional entry

001	Type
QSM	Push-in fitting/push-in connector, straight, mini series
QSML	Push-in fitting/push-in connector, L-shape, mini series
QSMT	Push-in connector, T-shape, mini series
QSMY	Push-in connector, Y-shape, mini series
QSMS	Push-in bulkhead connector, mini series

003	Pneumatic connection 2
-	Same size as connection 1
3	Push-in connector 3 mm
4	Push-in connector 4 mm
6	Push-in connector 6 mm

002	Pneumatic connection 1		
M3	M thread M3	4	Push-in connector 4 mm
M5	M thread M5	4H	Push-in sleeve 4 mm
M6	M thread M6	6	Push-in connector 6 mm
M7	M thread M7	6H	Push-in sleeve 6 mm
G1/8	G thread G1/8		
1/8	R thread R1/8		

004	Packaging unit
-	10 pieces

005	Installation method
-	Standard
I	With internal hex

Product options

- Push-in connector 2, 8, 10, 12 mm
- Push-in sleeve 3 mm
- Packaging unit 100 pieces

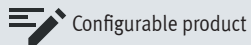

This product and all its product options can be ordered online via the configurator:

→ [www.festo.com/catalogue/qsm](http://www.festo.com/catalogue/qsm)



## Ordering

### Push-in fitting QSM, straight Male thread with external hex



Connection 1	Connection 2	Type	Part no.
<b>M thread with sealing ring</b>			
M3	4 mm	QSM-M3-4	★ 153303
M5	4 mm	QSM-M5-4	★ 153304
	6 mm	QSM-M5-6	★ 153306
M6	6 mm	QSM-M6-6	★ 132600
	<b>R thread</b>		
R1/8	4 mm	QSM-1/8-4	★ 153305
	6 mm	QSM-1/8-6	★ 153307
<b>G thread with sealing ring</b>			
G1/8	4 mm	QSM-G1/8-4	★ 186264
	6 mm	QSM-G1/8-6	★ 186265

### Push-in fitting QSML, L-shape, rotatable Male thread with external hex

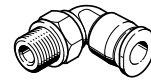

Connection 1	Connection 2	Type	Part no.
<b>M thread with sealing ring</b>			
M3	4 mm	QSML-M3-4	★ 153332
M5	4 mm	QSML-M5-4	★ 153333
	6 mm	QSML-M5-6	★ 153335
M7	4 mm	QSML-M7-4	★ 186352
	6 mm	QSML-M7-6	★ 186353
<b>R thread</b>			
R1/8	4 mm	QSML-1/8-4	★ 153334
	6 mm	QSML-1/8-6	★ 153336
<b>G thread with sealing ring</b>			
G1/8	4 mm	QSML-G1/8-4	★ 186268
	6 mm	QSML-G1/8-6	★ 186269

### Push-in connector QSM-...-I, straight Male thread with internal hex



Connection 1	Connection 2	Type	Part no.
<b>M thread with sealing ring</b>			
M3	4 mm	QSM-M3-4-I	★ 153314
M5	4 mm	QSM-M5-4-I	★ 153315
	6 mm	QSM-M5-6-I	★ 153317
M7	4 mm	QSM-M7-4-I	★ 153319
	6 mm	QSM-M7-6-I	★ 153321
<b>R thread</b>			
R1/8	4 mm	QSM-1/8-4-I	★ 153316
	6 mm	QSM-1/8-6-I	★ 153318
<b>G thread with sealing ring</b>			
G1/8	4 mm	QSM-G1/8-4-I	★ 186266
	6 mm	QSM-G1/8-6-I	★ 186267

### Push-in L-connector QSML, L-shape



Connection 1	Connection 2	Type	Part no.
4 mm	4 mm	QSML-4	★ 153344
6 mm	6 mm	QSML-6	★ 153345

### Push-in L-connector QSML-...H, L-shape With push-in sleeve

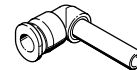

Connection 1	Connection 2	Type	Part no.
4 mm	4 mm	QSML-4H	★ 153347
6 mm	6 mm	QSML-6H	★ 153348
<b>Reducing</b>			
4 mm	3 mm	QSML-4H-3	★ 153349
6 mm	4 mm	QSML-6H-4	★ 153350

### Push-in connector QSM, straight



Connection 1	Connection 2	Type	Part no.
4 mm	4 mm	QSM-4	★ 153324
6 mm	6 mm	QSM-6	★ 153325
<b>Reducing</b>			
4 mm	3 mm	QSM-4-3	★ 153326
6 mm	4 mm	QSM-6-4	★ 153327

### Push-in T-connector QSMT, T-shape



Connection 1	Connection 2	Type	Part no.
4 mm	4 mm	QSMT-4	★ 153366
6 mm	6 mm	QSMT-6	★ 153367
<b>Reducing</b>			
4 mm	3 mm	QSMT-4-3	★ 153368
6 mm	4 mm	QSMT-6-4	★ 153369

### Push-in bulkhead connector QSMS



Connection 1	Connection 2	Type	Part no.
4 mm	4 mm	QSMS-4	★ 153376
6 mm	6 mm	QSMS-6	★ 153377

### Push-in Y-connector QSMY, Y-shape

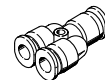

Connection 1	Connection 2	Type	Part no.
<b>Push-in connector/push-in connector</b>			
4 mm	4 mm	QSMY-4	★ 153371
6 mm	6 mm	QSMY-6	★ 153372
<b>Reducing</b>			
4 mm	3 mm	QSMY-4-3	★ 153373
6 mm	4 mm	QSMY-6-4	★ 153374

### Push-in connector QSM-...H With push-in sleeve

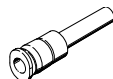

Connection 1	Connection 2	Type	Part no.
4 mm	3 mm	QSM-4H-3	★ 153328
6 mm	4 mm	QSM-6H-4	★ 153329

Fittings >

## Push-in fittings QS, standard series ★



- Simple and reliable connection and release
- Wide selection for maximum flexibility in standard applications
- Male or female thread with external or internal hexagon
- Resistant to pressure: economical for pneumatic installations up to 14 bar

### Order code

001 002 003 004 005 006 007

--	--	--	--	--	--	--

Legend:  Mandatory entry  Optional entry

001	Type
QS	Push-in fitting/push-in connector, straight, standard series
QSF	Push-in fitting, straight, standard series
QSL	Push-in fitting/push-in connector, L-shape, standard series
QSL	Push-in fitting, L-shape, long, standard series
QSLF	Push-in fitting, L-shape, standard series
QSLV	Push-in fitting, L-shape, standard series
QST	Push-in fitting/push-in connector, T-shape, standard series
QSTL	Push-in fitting, T-shape, standard series
QSY	Push-in fitting/push-in connector, Y-shape, standard series
QSVL	Push-in fitting, Y-shape, standard series
QSS	Push-in bulkhead connector, standard series
QSC	Push-in cap/blanking plug, standard series

002	Pneumatic connection 1		
M5	M thread M5	4	Push-in connector 4 mm
G1/8	G thread G1/8	4H	Push-in sleeve 4 mm
G1/4	G thread G1/4	6	Push-in connector 6 mm
G3/8	G thread G3/8	6H	Push-in sleeve 6 mm
G1/2	G thread G1/2	8	Push-in connector 8 mm
1/8	R thread R1/8	8H	Push-in sleeve 8 mm
1/4	R thread R1/4	10	Push-in connector 10 mm
3/8	R thread R3/8	10H	Push-in sleeve 10 mm
1/2	R thread R1/2	12	Push-in connector 12 mm
		12H	Push-in sleeve 12 mm
		14	Push-in connector 14 mm
		16	Push-in connector 16 mm

003	Additional feature
-	Standard
L	Long push-in sleeve
F	With fixed collar

004	Pneumatic connection 2
4	Push-in connector 4 mm
6	Push-in connector 6 mm
8	Push-in connector 8 mm
10	Push-in connector 10 mm
12	Push-in connector 12 mm

005	Packaging unit
-	10 pieces

006	Installation method
-	Standard
I	With internal hex

007	Generation
-	First generation
B	Second generation

### Product options

Types:  
QS-V0, resistant to welding spatter  
CRQS, stainless steel

Pneumatic connection 2:  
16 mm

Designs:  
W-shape, X-shape

Packaging units:  
20 pieces, 50 pieces, 100 pieces

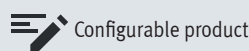

Configurable product

This product and all its product options can be ordered online via the configurator:

→ [www.festo.com/catalogue/qs](http://www.festo.com/catalogue/qs)

## Ordering

### Push-in fitting QS, straight Male thread with external hex



Connection 1	Connection 2	Type	Part no.
<b>R thread</b>			
R1/8	4 mm	QS-1/8-4	★ 153001
	6 mm	QS-1/8-6	★ 153002
	8 mm	QS-1/8-8	★ 153004
	10 mm	QS-1/8-10	★ 190643
R1/4	4 mm	QS-1/4-4	★ 190644
	6 mm	QS-1/4-6	★ 153003
	8 mm	QS-1/4-8	★ 153005
	10 mm	QS-1/4-10	★ 153007
	12 mm	QS-1/4-12	★ 164980
R3/8	6 mm	QS-3/8-6	★ 190645
	8 mm	QS-3/8-8	★ 153006
	10 mm	QS-3/8-10	★ 153008
	12 mm	QS-3/8-12	★ 153009
R1/2	10 mm	QS-1/2-10 <sup>1)</sup>	★ 190646
	12 mm	QS-1/2-12 <sup>1)</sup>	★ 153010
<b>G thread with sealing ring</b>			
G1/8	4 mm	QS-G1/8-4	★ 186095
	6 mm	QS-G1/8-6	★ 186096
	8 mm	QS-G1/8-8	★ 186098
G1/4	6 mm	QS-G1/4-6	★ 186097
	8 mm	QS-G1/4-8	★ 186099
	10 mm	QS-G1/4-10	★ 186101
	12 mm	QS-G1/4-12	★ 186350
G3/8	8 mm	QS-G3/8-8	★ 186100
	10 mm	QS-G3/8-10	★ 186102
	12 mm	QS-G3/8-12	★ 186103
G1/2	12 mm	QS-G1/2-12 <sup>1)</sup>	★ 186104

1) Packaging unit 1 piece

### Push-in fitting QS-...-I, straight Male thread with internal hex

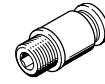

Connection 1	Connection 2	Type	Part no.
<b>R thread</b>			
R1/8	4 mm	QS-1/8-4-I	★ 153012
	6 mm	QS-1/8-6-I	★ 153013
	8 mm	QS-1/8-8-I	★ 153015
	10 mm	QS-1/8-10-I	★ 190647
R1/4	6 mm	QS-1/4-6-I	★ 153014
	8 mm	QS-1/4-8-I	★ 153016
	10 mm	QS-1/4-10-I	★ 153018
	12 mm	QS-1/4-12-I	★ 190649
R3/8	8 mm	QS-3/8-8-I	★ 153017
	10 mm	QS-3/8-10-I	★ 153019
	12 mm	QS-3/8-12-I	★ 153020
R1/2	10 mm	QS-1/2-10-I <sup>1)</sup>	★ 190648
	12 mm	QS-1/2-12-I <sup>1)</sup>	★ 153021
<b>G thread with sealing ring</b>			
G1/8	4 mm	QS-G1/8-4-I	★ 186106
	6 mm	QS-G1/8-6-I	★ 186107
	8 mm	QS-G1/8-8-I	★ 186109
G1/4	6 mm	QS-G1/4-6-I	★ 186108
	8 mm	QS-G1/4-8-I	★ 186110
	10 mm	QS-G1/4-10-I	★ 186112
G3/8	8 mm	QS-G3/8-8-I	★ 186111
	10 mm	QS-G3/8-10-I	★ 186113
	12 mm	QS-G3/8-12-I	★ 186114
G1/2	12 mm	QS-G1/2-12-I <sup>1)</sup>	★ 186115

1) Packaging unit 1 piece

### Push-in fitting QSF, straight Female thread with external hex

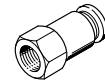

Connection 1	Connection 2	Type	Part no.
<b>G thread</b>			
G1/8	4 mm	QSF-1/8-4-B	★ 153022
	6 mm	QSF-1/8-6-B	★ 153023
	8 mm	QSF-1/8-8-B	★ 153025
G1/4	4 mm	QSF-1/4-4-B	★ 190650
	6 mm	QSF-1/4-6-B	★ 153024
	8 mm	QSF-1/4-8-B	★ 153026
	10 mm	QSF-1/4-10-B	★ 153028
	12 mm	QSF-1/4-12-B	★ 190651
G3/8	6 mm	QSF-3/8-6-B	★ 190652
	8 mm	QSF-3/8-8-B	★ 153027
	10 mm	QSF-3/8-10-B	★ 153029
	12 mm	QSF-3/8-12-B	★ 153030
G1/2	12 mm	QSF-1/2-12-B <sup>1)</sup>	★ 190653

1) Packaging unit 1 piece

Fittings >

Push-in fittings QS, standard series ★

Ordering

Push-in connector QS, straight

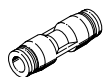

Connection 1	Connection 2	Type	Part no.
4 mm	4 mm	QS-4	★ 153031
6 mm	6 mm	QS-6	★ 153032
8 mm	8 mm	QS-8	★ 153033
10 mm	10 mm	QS-10	★ 153034
12 mm	12 mm	QS-12	★ 153035
Reducing			
6 mm	4 mm	QS-6-4	★ 153037
8 mm	4 mm	QS-8-4	★ 130606
	6 mm	QS-8-6	★ 153038
10 mm	6 mm	QS-10-6	★ 130607
	8 mm	QS-10-8	★ 153039
12 mm	8 mm	QS-12-8	★ 130608
	10 mm	QS-12-10	★ 153040

Push-in bulkhead connector QSS



Connection 1	Connection 2	Type	Part no.
4 mm	4 mm	QSS-4	★ 153157
6 mm	6 mm	QSS-6	★ 153158
8 mm	8 mm	QSS-8	★ 153159
10 mm	10 mm	QSS-10	★ 153160
12 mm	12 mm	QSS-12	★ 153161
With fixed collar			
8 mm	8 mm	QSS-8-F	★ 130642
10 mm	10 mm	QSS-10-F	★ 130643
12 mm	12 mm	QSS-12-F	★ 130644

Push-in cap QSC



Connection 1	Connection 2	Type	Part no.
4 mm	-	QSC-4	★ 153262
6 mm	-	QSC-6	★ 153263
8 mm	-	QSC-8	★ 153264
10 mm	-	QSC-10	★ 153265
12 mm	-	QSC-12	★ 153266

Push-in connector QS-...H, straight

With push-in sleeve

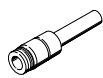

Connection 1	Connection 2	Type	Part no.
Reducing			
6 mm	4 mm	QS-6H-4	★ 153041
8 mm	4 mm	QS-8H-4	★ 130622
	6 mm	QS-8H-6	★ 153042
10 mm	6 mm	QS-10H-6	★ 130623
	8 mm	QS-10H-8	★ 153043
12 mm	6 mm	QS-12H-6	★ 132981
	8 mm	QS-12H-8	★ 130624
	10 mm	QS-12H-10	★ 153044

Blanking plug QSC-...H

Push-in sleeve

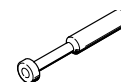

Connection 1	Connection 2	Type	Part no.
4 mm	Without	QSC-4H	★ 153267
6 mm	Without	QSC-6H	★ 153268
8 mm	Without	QSC-8H	★ 153269
10 mm	Without	QSC-10H	★ 153270
12 mm	Without	QSC-12H	★ 153271

Push-in L-fitting QSL, L-shape, rotatable

Male thread with external hex



Connection 1	Connection 2	Type	Part no.
R thread			
R1/8	4 mm	QSL-1/8-4	★ 153045
	6 mm	QSL-1/8-6	★ 153046
	8 mm	QSL-1/8-8	★ 153048
	10 mm	QSL-1/8-10	★ 190658
R1/4	4 mm	QSL-1/4-4	★ 190659
	6 mm	QSL-1/4-6	★ 153047
	8 mm	QSL-1/4-8	★ 153049
	10 mm	QSL-1/4-10	★ 153051
R3/8	6 mm	QSL-3/8-6	★ 190660
	8 mm	QSL-3/8-8	★ 153050
	10 mm	QSL-3/8-10	★ 153052
	12 mm	QSL-3/8-12	★ 153053
R1/2	10 mm	QSL-1/2-10 <sup>1)</sup>	★ 190661
	12 mm	QSL-1/2-12 <sup>1)</sup>	★ 153054
G thread with sealing ring			
G1/8	4 mm	QSL-G1/8-4	★ 186116
	6 mm	QSL-G1/8-6	★ 186117
	8 mm	QSL-G1/8-8	★ 186119
G1/4	6 mm	QSL-G1/4-6	★ 186118
	8 mm	QSL-G1/4-8	★ 186120
	10 mm	QSL-G1/4-10	★ 186122
	12 mm	QSL-G1/4-12	★ 186351
G3/8	8 mm	QSL-G3/8-8	★ 186121
	10 mm	QSL-G3/8-10	★ 186123
	12 mm	QSL-G3/8-12	★ 186124
G1/2	12 mm	QSL-G1/2-12 <sup>1)</sup>	★ 186125

1) Packaging unit 1 piece

## Ordering

### Push-in fitting QSLL, L-shape, long, rotatable



Connection 1	Connection 2	Type	Part no.
R thread (male thread with external hexagon)/push-in connector			
R1/8	4 mm	QSLL-1/8-4	★ 153076
	6 mm	QSLL-1/8-6	★ 153077
	8 mm	QSLL-1/8-8	★ 153079
R1/4	4 mm	QSLL-1/4-4	★ 190662
	6 mm	QSLL-1/4-6	★ 153078
	8 mm	QSLL-1/4-8	★ 153080
	10 mm	QSLL-1/4-10	★ 153082
R3/8	6 mm	QSLL-3/8-6	★ 190663
	8 mm	QSLL-3/8-8	★ 153081
	10 mm	QSLL-3/8-10	★ 153083
	12 mm	QSLL-3/8-12	★ 153084
R1/2	10 mm	QSLL-1/2-10 <sup>1)</sup>	★ 190664
	12 mm	QSLL-1/2-12 <sup>1)</sup>	★ 153085

1) Packaging unit 1 piece

### Push-in L-fitting QSFL, L-shape, rotatable Female thread with external hex



Connection 1	Connection 2	Type	Part no.
G thread			
G1/8	4 mm	QSFL-1/8-4-B	★ 153273
	6 mm	QSFL-1/8-6-B	★ 153274
	8 mm	QSFL-1/8-8-B	★ 153276
G1/4	6 mm	QSFL-1/4-6-B	★ 153275
	8 mm	QSFL-1/4-8-B	★ 153277
	10 mm	QSFL-1/4-10-B	★ 153279
G3/8	8 mm	QSFL-3/8-8-B	★ 153278
	10 mm	QSFL-3/8-10-B	★ 153280

### Push-in L-fitting QSLV, L-shape, rotatable Male thread with external hex



Connection 1	Connection 2	Type	Part no.
M thread			
M5	6 mm	QSLV-M5-6	★ 190666
R thread			
R1/8	4 mm	QSLV-1/8-4	★ 153086
	6 mm	QSLV-1/8-6	★ 153087
	8 mm	QSLV-1/8-8	★ 153089
R1/4	6 mm	QSLV-1/4-6	★ 153088
	8 mm	QSLV-1/4-8	★ 153090
	10 mm	QSLV-1/4-10	★ 153092
R3/8	8 mm	QSLV-3/8-8	★ 153091
	10 mm	QSLV-3/8-10	★ 153093
	12 mm	QSLV-3/8-12	★ 153094
R1/2	12 mm	QSLV-1/2-12 <sup>1)</sup>	★ 153095
G thread			
G1/8	4 mm	QSLV-G1/8-4	★ 186137
	6 mm	QSLV-G1/8-6	★ 186138
	8 mm	QSLV-G1/8-8	★ 186140
G1/4	6 mm	QSLV-G1/4-6	★ 186139
	8 mm	QSLV-G1/4-8	★ 186141
	10 mm	QSLV-G1/4-10	★ 186143
G3/8	8 mm	QSLV-G3/8-8	★ 186142
	10 mm	QSLV-G3/8-10	★ 186144
	12 mm	QSLV-G3/8-12	★ 186145
G1/2	12 mm	QSLV-G1/2-12 <sup>1)</sup>	★ 186146

1) Packaging unit 1 piece

### Push-in L-connector QSL, L-shape



Connection 1	Connection 2	Type	Part no.
4 mm	4 mm	QSL-4	★ 153070
6 mm	6 mm	QSL-6	★ 153071
8 mm	8 mm	QSL-8	★ 153072
10 mm	10 mm	QSL-10	★ 153073
12 mm	12 mm	QSL-12	★ 153074

### Push-in L-connector QSL...H, L-shape

#### With push-in sleeve



Connection 1	Connection 2	Type	Part no.
4 mm	4 mm	QSL-4H	★ 153056
6 mm	6 mm	QSL-6H	★ 153057
8 mm	8 mm	QSL-8H	★ 153058
10 mm	10 mm	QSL-10H	★ 153059
12 mm	12 mm	QSL-12H	★ 153060
Reducing			
6 mm	4 mm	QSL-6H-4	★ 153061
8 mm	6 mm	QSL-8H-6	★ 153062
10 mm	6 mm	QSL-10H-8	★ 153063
12 mm	10 mm	QSL-12H-10	★ 153064

#### Long push-in sleeve

Connection 1	Connection 2	Type	Part no.
4 mm	4 mm	QSL-4HL	★ 153065
6 mm	6 mm	QSL-6HL	★ 153066
8 mm	8 mm	QSL-8HL	★ 153067
10 mm	10 mm	QSL-10HL	★ 153068
12 mm	12 mm	QSL-12HL	★ 153069

### Push-in T-fitting QST, T-shape, rotatable Male thread with external hex

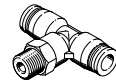

Connection 1	Connection 2	Type	Part no.
R thread			
R1/8	4 mm	QST-1/8-4	★ 153106
	6 mm	QST-1/8-6	★ 153107
	8 mm	QST-1/8-8	★ 153109
	10 mm	QST-1/8-10	★ 190667
R1/4	4 mm	QST-1/4-4	★ 190668
	6 mm	QST-1/4-6	★ 153108
	8 mm	QST-1/4-8	★ 153110
	10 mm	QST-1/4-10	★ 153112
R3/8	12 mm	QST-1/4-12	★ 190669
	6 mm	QST-3/8-6	★ 190670
	8 mm	QST-3/8-8	★ 153111
	10 mm	QST-3/8-10	★ 153113
R1/2	12 mm	QST-3/8-12	★ 153114
	10 mm	QST-1/2-10 <sup>1)</sup>	★ 190672
	12 mm	QST-1/2-12 <sup>1)</sup>	★ 153115

1) Packaging unit 1 piece

Fittings >

Push-in fittings QS, standard series ★

Ordering

Push-in T-connector QST, T-shape



Connection 1	Connection 2	Type	Part no.
4 mm	4 mm	QST-4	★ 153128
6 mm	6 mm	QST-6	★ 153129
8 mm	8 mm	QST-8	★ 153130
10 mm	10 mm	QST-10	★ 153131
12 mm	12 mm	QST-12	★ 153132
Reducing			
6 mm	4 mm	QST-6-4	★ 153134
8 mm	4 mm	QST-8-4	★ 130613
	6 mm	QST-8-6	★ 153135
10 mm	6 mm	QST-10-6	★ 130614
	8 mm	QST-10-8	★ 153136
12 mm	8 mm	QST-12-8	★ 130615
	10 mm	QST-12-10	★ 153137
16 mm	12 mm	QST-16-12 <sup>1)</sup>	★ 130616

1) Packaging unit 1 piece

Push-in T-fitting QSTL, T-shape, rotatable  
Male thread with external hex

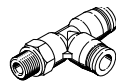

Connection 1	Connection 2	Type	Part no.
R thread			
R1/8	4 mm	QSTL-1/8-4	★ 153117
	6 mm	QSTL-1/8-6	★ 153118
	8 mm	QSTL-1/8-8	★ 153120
R1/4	6 mm	QSTL-1/4-6	★ 153119
	8 mm	QSTL-1/4-8	★ 153121
	10 mm	QSTL-1/4-10	★ 153123
R3/8	8 mm	QSTL-3/8-8	★ 153122
	10 mm	QSTL-3/8-10	★ 153124
	12 mm	QSTL-3/8-12	★ 153125
R1/2	12 mm	QSTL-1/2-12 <sup>1)</sup>	★ 153126

1) Packaging unit 1 piece

Push-in Y-fitting QSY, Y-shape, rotatable  
Male thread with external hex

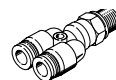

Connection 1	Connection 2	Type	Part no.
M thread with sealing ring			
M5	4 mm	QSY-M5-4	★ 190673
	6 mm	QSY-M5-6	★ 190674
R thread			
R1/8	4 mm	QSY-1/8-4	★ 153138
	6 mm	QSY-1/8-6	★ 153139
	8 mm	QSY-1/8-8	★ 153141
R1/4	4 mm	QSY-1/4-4	★ 190675
	6 mm	QSY-1/4-6	★ 153140
	8 mm	QSY-1/4-8	★ 153142
	10 mm	QSY-1/4-10	★ 153144
R3/8	8 mm	QSY-3/8-8	★ 153143
	10 mm	QSY-3/8-10	★ 153145
	12 mm	QSY-3/8-12	★ 153146
R1/2	12 mm	QSY-1/2-12 <sup>1)</sup>	★ 153147

1) Packaging unit 1 piece

Push-in Y-connector QSY, Y-shape

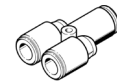

Connection 1	Connection 2	Type	Part no.
Push-in connector/push-in connector			
4 mm	4 mm	QSY-4	★ 153148
6 mm	6 mm	QSY-6	★ 153149
8 mm	8 mm	QSY-8	★ 153150
10 mm	10 mm	QSY-10	★ 153151
12 mm	12 mm	QSY-12	★ 153152
Reducing (2 reduced outlets)			
6 mm	4 mm	QSY-6-4	★ 153153
8 mm	4 mm	QSY-8-4	★ 130610
	6 mm	QSY-8-6	★ 153154
10 mm	6 mm	QSY-10-6	★ 130611
	8 mm	QSY-10-8	★ 153155
12 mm	8 mm	QSY-12-8	★ 130612
	10 mm	QSY-12-10	★ 153156
16 mm	12 mm	QSY-16-12 <sup>1)</sup>	★ 190708

1) Packaging unit 1 piece

Push-in Y-fitting QSYL, Y-shape, rotatable  
Male thread with external hex



Connection 1	Connection 2	Type	Part no.
R thread			
R1/8	4 mm	QSYL-1/8-4 <sup>1)</sup>	★ 153172
	6 mm	QSYL-1/8-6 <sup>1)</sup>	★ 153173
	8 mm	QSYL-1/8-8 <sup>1)</sup>	★ 153175
R1/4	6 mm	QSYL-1/4-6 <sup>1)</sup>	★ 153174
	8 mm	QSYL-1/4-8 <sup>1)</sup>	★ 153176
	10 mm	QSYL-1/4-10 <sup>1)</sup>	★ 153178
R3/8	8 mm	QSYL-3/8-8 <sup>1)</sup>	★ 153177
	10 mm	QSYL-3/8-10 <sup>1)</sup>	★ 153179
	12 mm	QSYL-3/8-12 <sup>1)</sup>	★ 153180
R1/2	12 mm	QSYL-1/2-12 <sup>1)</sup>	★ 153181

1) Packaging unit 1 piece



B-M3-S9



B-M5



B

- With sealing ring
- High-alloy stainless steel, aluminium, steel
- M thread, G thread

## Order code

001 002 003 004  
 -

Legend:  Mandatory entry  Optional entry

001	Type
B	Blanking plug
002	Pneumatic connection
M3	M thread M3
M5	M thread M5
M7	M thread M7
1/8	G thread G1/8
1/4	G thread G1/4
3/8	G thread G3/8
1/2	G thread G1/2
3/4	G thread G3/4
1	G thread G1

003	Version
-	Standard
S9	Corrosion- and acid-resistant version
004	Generation
-	First generation
B	Second generation

## Ordering

Blanking plug B					
Pneumatic connection	Material	Type	Part no.	PU <sup>1)</sup>	
M thread					
With external hexagon and sealing ring					
M3	High-alloy stainless steel	B-M3-S9	★ 30979	10	
M5	Aluminium	B-M5	★ 3843	10	
With internal hex and sealing ring					
M5	Galvanised steel	B-M5-B	★ 174308	10	
M7		B-M7	★ 174309	10	
G thread					
With internal hex and sealing ring					
G1/8	Galvanised steel	B-1/8	★ 3568	10	
G1/4		B-1/4	★ 3569	10	
G3/8		B-3/8	★ 3570	10	
G1/2		B-1/2	★ 3571	10	
G3/4		B-3/4	★ 3572	1	
G1		B-1	★ 5763	1	

1) Packaging unit

Couplings >

Quick coupling sockets/plugs NPHS-D/NPHS-S, KD ★



Safety coupling NPHS

- To ISO 4414
- Releasing sleeve made of metal or polymer
- Integrated hand slide valve
- Shut-off at one end

Plug-in coupling KD4

- For standard applications, without safety function
- Housing made from nickel-plated brass
- Releasing sleeve made from polymer
- Shut-off at one end
- Quick coupling sockets KD4 can be combined with all quick coupling plugs NPHS-S6

Order code

Safety coupling NPHS

001 002 003 004 005 006  
 NPHS - [ ] 6 - [ ] - [ ] [ ]

001	Type
NPHS	Safety coupling
002	Coupling element
D	Quick coupling socket
S	Quick coupling plug
003	Coupling size
6	Size 6
004	Releasing sleeve version
M	Metal
P	Polymer
005	Pneumatic connection 1
G18	G1/8
G14	G1/4
G38	G3/8
G12	G1/2
006	Thread type connection 1
-	Male thread
F	Female thread

Order code

Plug-in coupling KD

001 002 003 004  
 KD 4 - [ ] - A

001	Type
KD	Plug-in coupling with quick coupling socket
002	Coupling size
4	Size 4
003	Pneumatic connection 1
1/4	G1/4
3/8	G3/8
1/2	G1/2
004	Thread type connection 1
A	Male thread

Legend: [ ] Mandatory entry [ ] Optional entry

Product options

Pneumatic connection 1:

- Barbed fitting
- Female thread
- Quick connector with union nut
- Bulkhead quick connector with union nut

Type KS4: Plug-in coupling with quick coupling plug

Configurable product

This product and all its product options can be ordered online via the configurator:

→ [www.festo.com/catalogue/nphs](http://www.festo.com/catalogue/nphs)



Quick coupling sockets/plugs NPHS-D/NPHS-S, KD ★

Ordering – Quick coupling socket/plug NPHS-D/NPHS-S

Quick coupling plug NPHS-S6				Quick coupling socket NPHS-D6-P					
006 Thread connection 1	005 Pneumatic connection 1	Type	Part no.	Type	Part no.	Type	Part no.	Type	Part no.
				<b>NPHS-D6-P-G14</b>	★ <b>8059267</b>	<b>NPHS-D6-P-G38</b>	★ <b>8059268</b>	<b>NPHS-D6-P-G12</b>	★ <b>8059269</b>
Standard nominal flow rate $q_{nN}^1$ for quick coupling socket/plug combination									
Male thread	G1/8	<b>NPHS-S6-M-G18</b>	★ <b>8059257</b>	1183 l/min		1216 l/min		1233 l/min	
	G1/4	<b>NPHS-S6-M-G14</b>	★ <b>8059258</b>	1916 l/min		2033 l/min		2016 l/min	
	G3/8	<b>NPHS-S6-M-G38</b>	★ <b>8059259</b>	1883 l/min		2033 l/min		1983 l/min	
	G1/2	<b>NPHS-S6-M-G12</b>	★ <b>8059260</b>	1883 l/min		1966 l/min		1950 l/min	
Female thread	G1/4	<b>NPHS-S6-M-G14F</b>	★ <b>8059262</b>	1883 l/min		1950 l/min		1916 l/min	
	G3/8	<b>NPHS-S6-M-G38F</b>	★ <b>8059263</b>	1966 l/min		2083 l/min		2016 l/min	
	G1/2	<b>NPHS-S6-M-G12F</b>	★ <b>8059264</b>	1883 l/min		2000 l/min		1983 l/min	

Ordering – Quick coupling socket/plug KD/NPHS-S

Quick coupling plug NPHS-S6				Quick coupling socket KD4					
006 Thread connection 1	005 Pneumatic connection 1	Type	Part no.	Type	Part no.	Type	Part no.	Type	Part no.
				<b>KD4-1/4-A</b>	★ <b>2143</b>	<b>KD4-3/8-A</b>	★ <b>2144</b>	<b>KD4-1/2-A</b>	★ <b>2145</b>
Standard nominal flow rate $q_{nN}^1$ for quick coupling socket/plug combination									
Male thread	G1/4	<b>NPHS-S6-M-G14</b>	★ <b>8059258</b>	1260 l/min		1242 l/min		1296 l/min	
	G3/8	<b>NPHS-S6-M-G38</b>	★ <b>8059259</b>	1283 l/min		1274 l/min		1319 l/min	
	G1/2	<b>NPHS-S6-M-G12</b>	★ <b>8059260</b>	1283 l/min		1260 l/min		1301 l/min	
Female thread	G1/4	<b>NPHS-S6-M-G14F</b>	★ <b>8059262</b>	1125 l/min		1125 l/min		1148 l/min	
	G3/8	<b>NPHS-S6-M-G38F</b>	★ <b>8059263</b>	1287 l/min		1274 l/min		1337 l/min	
	G1/2	<b>NPHS-S6-M-G12F</b>	★ <b>8059264</b>	1287 l/min		1260 l/min		1305 l/min	

1) Measured at  $p_1 = 6$  bar and  $\Delta p = 1$  bar

# 12

## Electrical connection technology



# Highlights

# Contents

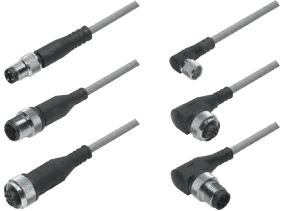

Connecting cables

### NEBU

- + The modular cable system with unlimited combination options of plugs, plug sockets, cable lengths and qualities
- + Adapted to all devices with M8 and M12 plugs
- + Cable length 0.1 ... 30 m

→ 183

Product overview \_\_\_\_\_ 178

Overview: Connecting cable NEBU, universal ★ \_\_\_\_\_ 182

Connecting cables NEBU, universal ★ \_\_\_\_\_ 183

Product overview

Software-Tools

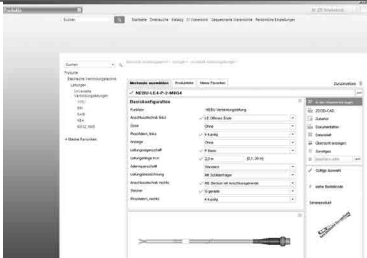
<b>Configurator</b>		<p>Design a product with numerous features reliably and quickly with the help of the configurator.</p> <p>Select all the required product features step by step. The use of logic checks ensures that only correct configurations are available for selection.</p> <p>A dynamic graphic generated on the basis of the configuration provides a visual aid for selecting the correct product features.</p> <p>The configurator is part of the electronic catalogue and is not available as a separate software program.</p>
---------------------	---	--

Universal connecting cables

 <p>Connecting cables <b>NEBU</b></p>	
<b>Electrical connection, connection type</b>	Socket, cable, plug
<b>Electrical connection, cable outlet</b>	Straight, angled, can be adjusted in 15° steps
<b>Electrical connection, design</b>	Round
<b>Electrical connection, connection technology</b>	M8x1 A-coded to EN 61076-2-104, G7/8 coded to NFPA/T3.5.29 R1-2007, M12x1 A-coded to EN 61076-2-101, open end
<b>Electrical connection, number of pins/wires</b>	3, 4, 5, 8
<b>Cable length</b>	0.1 ... 30 m
<b>Description</b>	<ul style="list-style-type: none"> <li>• Designs for static, standard, energy chain and robot applications</li> <li>• Designs with switching status indication</li> <li>• Designs for connecting sensors and actuators</li> </ul>
<b>→ Page/online</b>	<b>183</b>

## Connecting cables for control systems



	 <p>Connecting cables NEBC</p>
<b>Electrical connection</b>	Straight plug, straight plug, USB 2.0 type B, 4-pin, straight plug, RJ45, 4-pin, straight plug, USB 2.0 type A, 4-pin, straight plug, M12x1, 4-pin, D-coded, straight plug, Sub-D, 25-pin, open end, 26-wire, open end, 4-wire, 5-pin, 25-pin, straight plug/open end, square design/angled, Sub-D/Sub-D, Sub-D/-, M12x1
<b>Electrical connection, connection type</b>	Socket, plug, hybrid plug, cable
<b>Electrical connection, cable outlet</b>	Straight, angled
<b>Electrical connection, design</b>	Square, round
<b>Electrical connection, connection technology</b>	M12x1 Festo-specific coding, M9x0.5, USB 3.0 type A, M12x1 A-coded to EN 61076-2-101, open end, RJ45, Sub-D, USB 3.0 type B micro
<b>Electrical connection, number of pins/wires</b>	5, 8, 9, 10, 15
<b>Cable length</b>	0.2 ... 30 m
<b>Description</b>	<ul style="list-style-type: none"> <li>For I/O interface</li> <li>For connecting motor controller CMMS-ST to any controllers</li> </ul>
<b>→ Page/online</b>	<a href="#">nebc</a>

## Connecting cables for motors

	 <p>Motor, encoder, resolver cables NEBM</p>
<b>Electrical connection, connection type</b>	Socket, hybrid socket, cable, plug, plug and cable
<b>Electrical connection, cable outlet</b>	Straight, angled
<b>Electrical connection, design</b>	Square, round
<b>Electrical connection, connection technology</b>	Connection pattern F1, connection pattern L4, connection pattern L5, ITT M3, RJ45, RJ45 and open end, Sub-D, M12x1 A-coded to EN 61076-2-101, open end, M16x0.75, M23x1, M40x1.5
<b>Electrical connection, number of pins/wires</b>	2, 4, 6, 8, 9, 10, 12, 14, 15, 18, 28, 31
<b>Cable length</b>	0.5 ... 100 m
<b>Description</b>	<ul style="list-style-type: none"> <li>For servo motor EMMS-AS and stepper motor EMMS-ST</li> <li>Suitable for use with energy chains</li> </ul>
<b>→ Page/online</b>	<a href="#">nebm</a>

Product overview

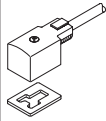

Connecting cables for valves

	 Connecting cables NEBV	 Plug sockets with cable KMEB-1, KMEB-2, KMEB-3	 Plug sockets with cable KMF
<b>Electrical connection</b>	Sub-D socket, 25-pin, socket, open end, 15-wire, open end, 25-wire, Sub-D, 44-pin, angled socket/straight plug, angled socket/cable, M8x1/M8x1, 4-pin/3-pin, 4-pin/2-wire, M8x1	Angled socket, to DIN EN 175301-803, type C, 2-pin, 3-pin, 4-pin, 5-pin	Socket
<b>Electrical connection, connection type</b>	2x individual wire, socket, narrow socket, cable, plug		
<b>Electrical connection, cable outlet</b>	Straight, angled		
<b>Electrical connection, design</b>	Square, round		
<b>Electrical connection, connection technology</b>	Connection pattern ZB, self-tapping screw, connection pattern ZC, self-tapping screw, connection pattern ZC, metric screw, connection pattern H, connection pattern S, M12x1 A-coded to EN 61076-2-101, connection pattern type A based on EN 175301-803, connection pattern type B to industry standard 11 mm, connection pattern type C to EN 175301-803, M8x1 A-coded to EN 61076-2-104, open end, Sub-D		
<b>Electrical connection, number of pins/wires</b>	2, 3, 4, 5, 8, 10, 25, 26, 27, 36, 37, 44		
<b>Cable length</b>	0.2 ... 30 m	0.5 ... 10 m	2.5 ... 10 m
<b>Description</b>	<ul style="list-style-type: none"> <li>• Pre-assembled at both ends</li> </ul>	<ul style="list-style-type: none"> <li>• For valves with EB solenoid coil</li> <li>• With PVC or PU cable</li> <li>• Mounting via central screw</li> </ul>	<ul style="list-style-type: none"> <li>• For valves with F solenoid coil</li> <li>• Mounting via central screw</li> <li>• Polyvinyl chloride cable</li> <li>• Ambient temperature -20 ... +80 °C</li> </ul>
<b>→ Page/online</b>	<a href="#">nebv</a>	<a href="#">kmeb-1</a>	<a href="#">kmf</a>

Universal plug connectors

	 Distributors NEDY
<b>Electrical connection, connection type</b>	2x socket, 2x cable, cable, plug
<b>Electrical connection, design</b>	Square, round
<b>Electrical connection, connection technology</b>	Connection pattern ZB, self-tapping screw, connection pattern ZC, self-tapping screw, connection pattern ZC, metric screw, connection pattern H, connection pattern type A to EN 175301-803, connection pattern type B to EN 175301-803, connection pattern type B to industry standard 11 mm, connection pattern type C to EN 175301-803, connection pattern type C to industry standard 9.4 mm, M8x1 A-coded to EN 61076-2-104, M12x1 A-coded to EN 61076-2-101, open end
<b>Electrical connection, number of pins/wires</b>	2, 3, 4, 5
<b>Degree of protection</b>	IP65, IP67, IP68, IP69K
<b>Description</b>	<ul style="list-style-type: none"> <li>• Collecting signals between field devices (sensors) and controller inputs with double assignment</li> <li>• Distributing signals between controller outputs with double assignment and field devices (actuators, e.g. valves)</li> </ul>
<b>→ Page/online</b>	<a href="#">nedy</a>

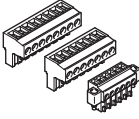
## Plug connectors for control systems

	 <p>Plug assortments NEKM</p>	 <p>Plugs NEFC-S1G25</p>
<b>Electrical connection, connection technology</b>	Screw connector	
<b>Electrical connection, number of pins/wires</b>	2 ... 9	
<b>Description</b>	<ul style="list-style-type: none"> <li>• For motor controller CMMS-ST, CMMO-ST, CMMP-AS</li> </ul>	<ul style="list-style-type: none"> <li>• 25-pin sub-D plug</li> <li>• Each wire can be individually assembled using screw terminals</li> </ul>
→ <b>Page/online</b>	<a href="#">nekm</a>	<a href="#">nefc</a>

## Plug connectors for valves

	 <p>Plug sockets MSSD</p>
<b>Electrical connection</b>	Socket, angled socket, angled socket, square design, 3-pin, type C, socket, to EN 175301-803, type C, square design, square design MSC, square design MSEB, square design MSF, square design MSN1, square design MSN2, square design MSV, to DIN EN 175301-803, to DIN EN 61984, type A, type B, type C, 3-pin, 4-pin
<b>Electrical connection, connection type</b>	Socket
<b>Electrical connection, design</b>	Square
<b>Electrical connection, connection technology</b>	Connection pattern type A to EN 175301-803, connection pattern type B to industry standard 11 mm, screw terminal
<b>Electrical connection, number of pins/wires</b>	3
<b>Connection cross section</b>	0.25 ... 1.5 mm <sup>2</sup>
<b>Degree of protection</b>	IP50, IP65, IP67, to IEC 60529
<b>Description</b>	<ul style="list-style-type: none"> <li>• For valves with F, D, N1, V, E, EB, N2, Y, Z, ZB, ZC, MD-2 and MH-2 solenoid coils</li> <li>• For connecting individual valves</li> <li>• Optionally with LED display</li> </ul>
→ <b>Page/online</b>	<a href="#">mssd</a>

Cables > Connecting cables, universal >

## Overview: Connecting cable NEBU, universal ★

The configurable connecting cables offer unlimited combinations in terms of plug sockets, cable lengths, cable qualities and plugs. They match all devices with M8 and M12 plugs such as proximity sensors, position transmitters, pressure and flow sensors, optical and inductive sensors as well as individual valves. Cable

lengths are freely selectable within a range of 0.1 ... 30 m.

The ends and middle pieces can also be freely selected for maximum customisation.

### Basic

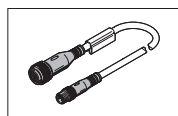
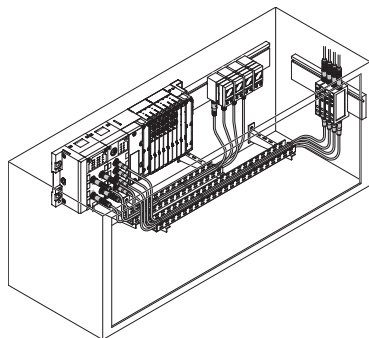

#### Applications

Static installation, no or small mechanical load

#### Properties of basic cables

Price-optimised cable for simple, mainly static applications

### Standard

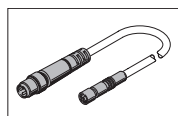
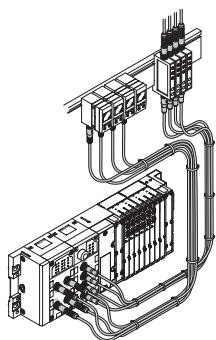

#### Applications

Low to average mechanical load, energy chains with large radius  $\geq 75$  mm

#### Properties of standard cables

Good oil resistance, good bending properties, suitable for use with energy chains

### Energy chain

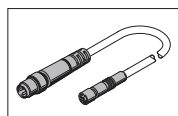
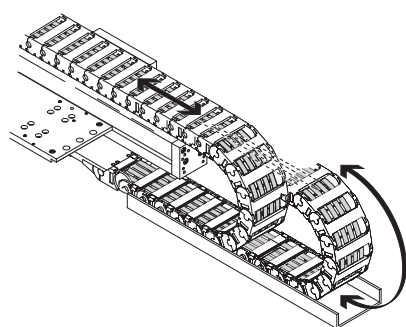

#### Applications

Energy chain applications involve high mechanical loads, particularly if very small radii are required.

#### Properties of cables suitable for use with energy chains

Very good oil resistance, very good bending properties, highly suitable for energy chains, halogen-free

### Robot

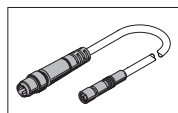
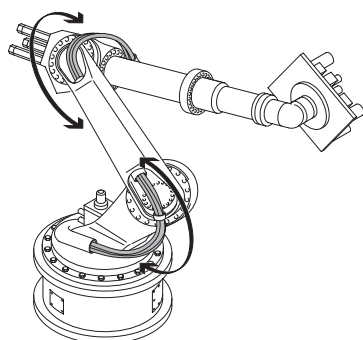

#### Applications

Robot applications involve high mechanical loads that are primarily caused by torsion.

#### Properties of robot cables

Very good oil resistance, very good bending properties, suitable for use with energy chains, halogen-free

The technical data as well as an overview of the range of options for the connecting cables NEBU can be found online

→ [www.festo.com/catalogue/nebu](http://www.festo.com/catalogue/nebu)



Connecting cables NEBU, universal ★



- Plug socket with cable for connecting inputs/outputs
- Pre-assembled at both ends

Order code – Basic design

001 002 003 004 005 006 007 008 009  
 NEBU - [ ] - [ ] - [ ] - K - [ ] - [ ] - [ ] - [ ]

Legend: [ ] Mandatory entry [ ] Optional entry

001	Type
NEBU	Connecting cable, universal
002	Connection technology on the left, field device side
M8	Socket M8x1, A-coded, EN 61076-2-104
M12	Socket M12x1, A-coded, EN 61076-2-101
003	Connection technology version, left
G3	Straight, 3-pin
G5	Straight, 5-pin
W3	Angled, 3-pin
004	Display
-	Without LED
005	Cable characteristic
K	Standard

006	Cable length
0,5	0.5 m
1	1 m
2,5	2.5 m
5	5 m
10	10 m
007	Cable designation
-	With inscription label holder
008	Connection technology on the right, control side
M8	Plug M8x1, A-coded, EN 61076-2-104
LE	Open cable end
009	Connection technology version, right
3	Open cable end, 3-wire
4	Open cable end, 4-wire
G3	Plug, straight, 3-pin

Product options

- Connection technology version
- Rotatable
- Cable characteristics
- Suitable for use with energy chains
  - Suitable for robot applications

- With LED display

Configurable product

This product and all its product options can be ordered online via the configurator:  
 → [www.festo.com/catalogue/nebu](http://www.festo.com/catalogue/nebu)

Ordering – Basic design

Connecting cables, M8, 3-pin			
Cable length	Connection on the right	Type	Part no.
Connection on the left: socket M8, straight, 3-pin			
0.5 m	Plug M8, straight, 3-pin	NEBU-M8G3-K-0.5-M8G3	★ 541346
1 m		NEBU-M8G3-K-1-M8G3	★ 541347
2.5 m		NEBU-M8G3-K-2.5-M8G3	★ 541348
5 m		NEBU-M8G3-K-5-M8G3	★ 541349
2.5 m	Open cable end, 3-wire	NEBU-M8G3-K-2.5-LE3	★ 541333
5 m		NEBU-M8G3-K-5-LE3	★ 541334
10 m		NEBU-M8G3-K-10-LE3	★ 541332
Connection on the left: socket M8, angled, 3-pin			
2.5 m	Open cable end, 3-wire	NEBU-M8W3-K-2.5-LE3	★ 541338
5 m		NEBU-M8W3-K-5-LE3	★ 541341
10 m		NEBU-M8W3-K-10-LE3	★ 541335

Connecting cables, M12, 5-pin			
Cable length	Connection on the right	Type	Part no.
Connection on the left: socket M12, straight, 5-pin			
2.5 m	Open cable end, 3-wire	NEBU-M12G5-K-2.5-LE3	★ 541363
5 m		NEBU-M12G5-K-5-LE3	★ 541364
2.5 m	Open cable end, 4-wire	NEBU-M12G5-K-2.5-LE4	★ 550326
5 m		NEBU-M12G5-K-5-LE4	★ 541328

# 13

## Control technology and software

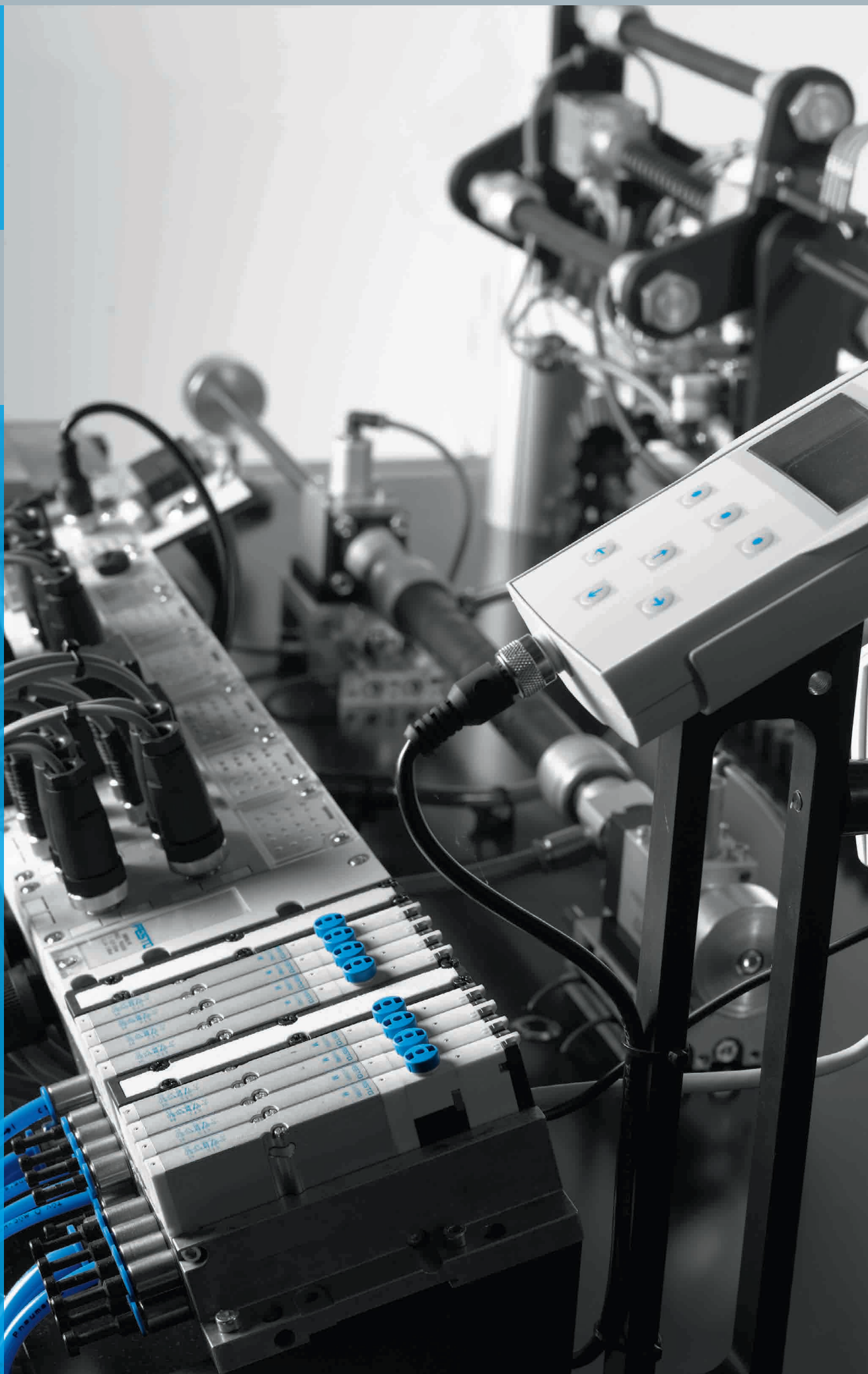

# Highlights

# Contents



Terminals

## CPX



- + Installation variants: stand-alone, remote I/O or with valve terminal VTSA/MPA
- + Digital or analogue input/output modules
- + Optional CODESYS controller

→ 186

Product overview \_\_\_\_\_ 186

Product overview

Electrical peripherals

	 <p>Terminals CPX</p>	 <p>Fieldbus modules CTEU</p>
<b>Address capacity, inputs</b>	64 Byte	2 ... 64 Byte
<b>Address capacity, outputs</b>	64 Byte	2 ... 64 Byte
<b>Electrical control</b>	Fieldbus, integrated controller	
<b>Protocol</b>	AS-Interface, CANopen, CC-Link, DeviceNet, EtherCAT, EtherNet/IP, PROFINET, Modbus® TCP, PROFIBUS DP	
<b>Description</b>	<ul style="list-style-type: none"> <li>Automation platform</li> <li>Open to all common fieldbus protocols and Ethernet</li> <li>Integrated diagnostic and maintenance functions</li> <li>Can be used as stand-alone remote I/O or with valve terminals MPA-S, MPA-L, VTSA/VTSA-F</li> <li>Choice of polymer or metal interlinking block with individual links</li> <li>Analogue inputs and outputs, 2-way/4-way, optionally with HART protocol</li> </ul>	<ul style="list-style-type: none"> <li>For valve terminals VTUB-12, VTUG, MPA-L, CPV, VTOC</li> <li>Can be expanded into installation system CTEL</li> <li>Fieldbus-typical LEDs, interfaces and switching elements</li> <li>Isolated power supply for electronics and valves</li> </ul>
<b>→ Page/online</b>	<a href="#">cpx</a>	<a href="#">cteu</a>



# 14

## Other pneumatic equipment

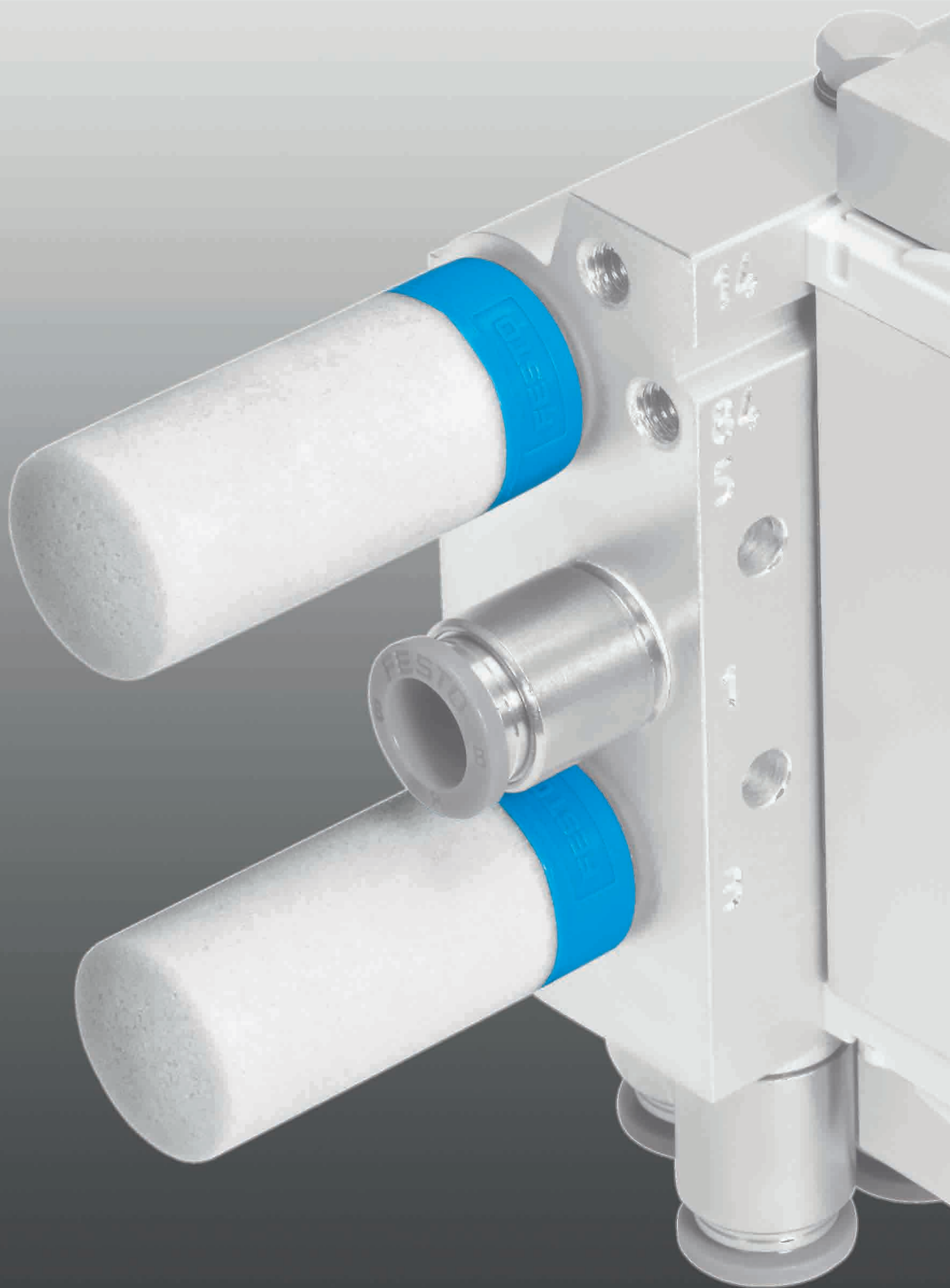

# Highlights

# Contents



Silencers  
**AMTE**  
+ Metal version  
+ High temperature resistance up to 80 °C  
+ Slim overall width  
+ Many different variants  
+ Universal applications  
→ 191





Silencers  
**U**  
+ Polymer design  
+ Connection thread G1/8, G1/4, G3/8, G1/2, G3/4, G1  
+ Noise level 74 ... 90 dB(A)  
→ 192

Product overview	190
Silencers AMTE ★	191
Silencers U ★	192

Product overview

Silencers

	 <b>Silencers AMTE</b>	 <b>Silencers U</b>	 <b>Silencers UOM, UOMS</b>
<b>Information on silencer insert materials</b>	Bronze	PE, bronze	PU foam
<b>Pneumatic connection</b>	G1, G1/2, G1/4, G1/8, G3/4, G3/8, M3, M5, NPT1/2-14, NPT1/4-18, NPT1/8-27, NPT3/8-18, UNF10-32	G1, G1/2, G1/4, G1/8, G3/4, G3/8, NPT3/4-14, PK-3, PK-4	G1/4, G3/8
<b>Noise level</b>	55 ... 95 dB(A)	70 ... 90 dB(A)	
<b>Description</b>	<ul style="list-style-type: none"> <li>• Long or short design</li> <li>• Metal version</li> <li>• Operating medium: compressed air</li> <li>• High temperature resistance up to 80 °C</li> <li>• Slim overall width</li> <li>• Many different variants</li> <li>• Universal applications</li> </ul>	<ul style="list-style-type: none"> <li>• Compact design, polymer or die-cast metal</li> <li>• Barbed connector or threaded connection</li> <li>• Operating medium: compressed air</li> </ul>	<ul style="list-style-type: none"> <li>• Special open minimal resistance silencer</li> <li>• For vacuum generators</li> <li>• Facilitates trouble-free operation of the vacuum generator</li> <li>• Silencer extension for extending the silencer for further noise reduction</li> <li>• Operating medium: compressed air</li> </ul>
<b>→ Page/online</b>	<b>191</b>	<b>192</b>	<b>uom</b>

Reservoirs

	 <b>Air reservoirs CRVZS</b>
<b>Volume</b>	0.1 l, 0.4 l, 0.75 l, 10 l, 2 l, 20 l, 5 l
<b>Information on air reservoir materials</b>	High-alloy stainless steel
<b>Conforms to standard</b>	AD 2000
<b>Condensate drain connection</b>	G3/8
<b>Description</b>	<ul style="list-style-type: none"> <li>• Corrosion-resistant</li> <li>• Can be used to compensate pressure fluctuations, and act as accumulators in the event of sudden air consumption</li> <li>• Providing large quantities of compressed air for supplying fast pulsing drives</li> <li>• With connection for condensate drain in some cases</li> <li>• Food-safe, see <a href="http://www.festo.com/sp/crvzs">www.festo.com/sp/crvzs</a> &gt; "Certificates" tab</li> <li>• Designs to EU Pressure Equipment Directive EN 286-1</li> <li>• Operating media: compressed air, vacuum</li> </ul>
<b>→ Page/online</b>	<b>crvzs</b>





- Suitable for reducing noise at the exhaust ports of pneumatic systems
- Metal design
- Long design

## Ordering

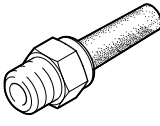
Version	Type	Part no.	PU <sup>1)</sup>	Pneumatic connection D1		Noise level [dB (A)]
				M thread	G thread	
Long design						
	AMTE-M-LH-M5	★ 1205858	20	M5	–	< 72
	AMTE-M-LH-G18	★ 1205860	20	–	G1/8	< 76
	AMTE-M-LH-G14	★ 1205861	20	–	G1/4	< 83
	AMTE-M-LH-G38	★ 1205862	10	–	G3/8	< 82
	AMTE-M-LH-G12	★ 1205863	10	–	G1/2	< 88

1) Packaging unit

## Product options

Short version

Pneumatic connection D1

- M3 M3 thread, long version
- N... NPT thread, long version
- U 10-32 UNF-2A thread

 Configurable product

This product and all its product options can be ordered online via the configurator:

→ [www.festo.com/catalogue/amte](http://www.festo.com/catalogue/amte)

## Silencers U ★



• For noise reduction at the exhaust ports of pneumatic components

• Polymer or die-cast metal design

## Ordering

Version	Type	Part no.	PU <sup>1)</sup>	Connection D1		Noise level [dB (A)]
				G thread		
Polymer, male thread						
	U-1/8	★ 2307	1	G1/8		< 74
	U-1/4	★ 2316	1	G1/4		< 76
	U-3/8	★ 2309	1	G3/8		< 82
	U-1/2	★ 2310	1	G1/2		< 82
	U-3/4	★ 2311	1	G3/4		< 85
	U-1	★ 2312	1	G1		< 90

1) Packaging unit

## Product options

Die-cast design

Configurable product

This product and all its product options can be ordered online via the configurator:

→ [www.festo.com/catalogue/u](http://www.festo.com/catalogue/u)



15

Process automation



# Highlights



Sensor boxes  
**SRBC**  
+ Weatherproof aluminium housing  
+ Cost-optimised, high-performance and reliable series  
→ 205



Positioners  
**CMSX**  
+ Very energy-efficient: no compressed air consumption at standstill  
+ Ideal for proportional flow control at process valves (e.g. flow control, dispensing/mixing)  
→ 207



Solenoid valves, to NAMUR  
**VSNC**  
+ Certified in accordance with established explosion standards  
+ Sturdy and capable of high flow rates  
→ 102



Quarter turn actuators  
**DFPD**  
+ Flange hole pattern to ISO 5211  
+ Connection pattern to NAMUR for solenoid valves and sensor boxes to VDI/VDE 3845  
→ 209

# Contents

Standardising and automating process valves \_\_\_\_\_ 196  
 Product overview \_\_\_\_\_ 197  
 Sensor boxes SRBC ★ \_\_\_\_\_ 205  
 Positioners CMSX ★ \_\_\_\_\_ 207  
 Quarter turn actuators DFPD ★ \_\_\_\_\_ 209  
 Angle seat valves VZXF ★ \_\_\_\_\_ 211  
 Solenoid valves VZWD, directly actuated ★ \_\_\_\_\_ 213  
 Solenoid valves VZWF, force pilot operated ★ \_\_\_\_\_ 214  
 Solenoid valves VZWM ★ \_\_\_\_\_ 215  
 Solenoid coils VACC-S13-18-K4-...-EX4ME, with explosion protection ★ \_\_\_\_\_ 216

## Standardising and automating process valves

Fully automated process valves from a single source make planning, procurement and commissioning significantly easier and cost effective. They eliminate a considerable amount of project management work, reduce warehousing costs for spare parts, and speed up service and maintenance.

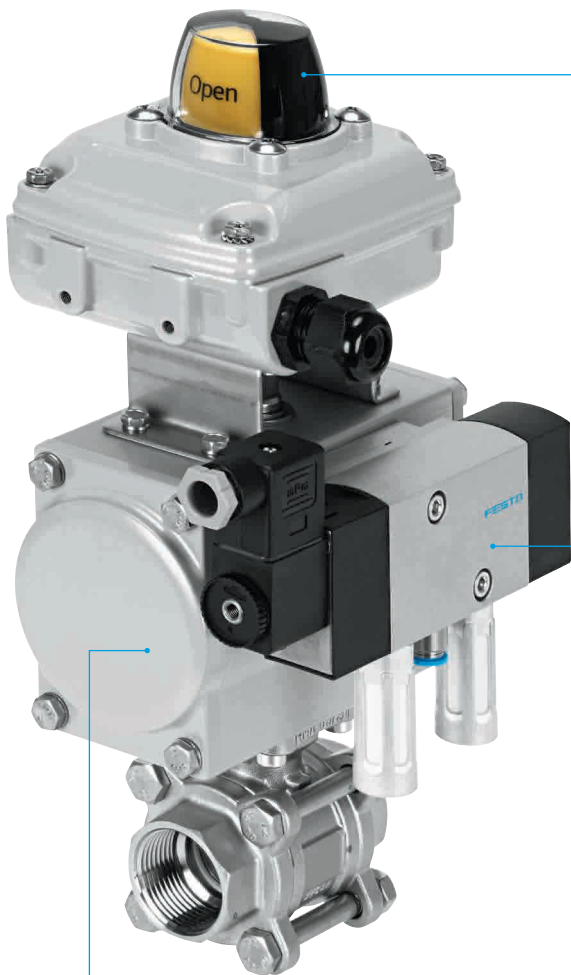

**Quarter turn actuator DFPD**  
The new benchmark for quarter turn actuators. Its range of variants and standardised hole patterns to NAMUR VDI/VDE 3845 for pilot valves open up a wide variety of possible applications.  
→ 199



**Position sensing for all application areas**  
Whether for open solutions with the sensor SRBG, the sturdy sensor box SRBC for basic applications in indoor and outdoor areas, or the all-rounder SRBE for explosion-proof areas, Festo always has the right solution.  
→ 198

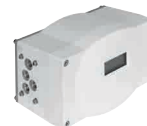

**An alternative to the sensor box: the reliable positioner CMSX for analogue control**  
It enables the positions of quarter turn actuators to be accurately sensed and flow rates to be controlled, for example.  
→ 198



**Standard NAMUR valve VSNC**  
Controls quarter turn actuators and linear actuators with a VDI/VDE 3845 interface. Globally certified in accordance with current Ex standards. Now also available with poppet valve technology.  
→ 197



**Pilot valves VOFC/VOFD**  
An extremely sturdy alternative to the valve VSNC. Ideal for outdoor areas and potentially explosive atmospheres. The extremely sturdy VOFC/VOFD can control valve actuators in the chemical, petrochemical and pharmaceutical production plants of leading companies worldwide.  
→ 197

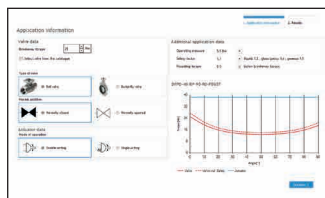



Software tools for easy selection and configuration of process valve units.  
→ [www.festo.com/process](http://www.festo.com/process)



We offer a wide selection of tubing and fittings for a broad range of applications, from standard applications to applications with specific external influences.  
→ Pneumatic connection technology  
→ 158

You can find the appropriate components here:  
→ [www.festo.com/productfinder/fittings](http://www.festo.com/productfinder/fittings)

## Pilot valves



	 <b>Solenoid valves VSNC</b>	 <b>Solenoid valves VOFC</b>	 <b>Solenoid valves VOFD</b>
<b>Valve function</b>	5/2-way, double solenoid, 5/2-way or 3/2-way, convertible, 5/3-way, pressurised, 5/3-way, exhausted, 5/3-way, closed	3/2-way, single solenoid, closed, 5/2-way, double solenoid, 5/2-way, single solenoid	3/2-way, single solenoid, closed, semi-automatic, 3/2-way, single solenoid, closed
<b>Operating pressure</b>	1.5 ... 10 bar	0 ... 10 bar	0 ... 12 bar
<b>Ambient temperature</b>	-20 ... 60°C	-25 ... 60°C	-50 ... 60°C
<b>Pneumatic port 1</b>	1/4 NPT, G1/4, QS-1/4, QS-10, QS-3/8, QS-5/16, QS-6, QS-8	Connection pattern to NAMUR, G1/2, G1/4, M5, NPT1/4-18	Connection pattern to NAMUR, 1/4 NPT, G1/4, M5
<b>Standard nominal flow rate</b>	800 ... 1350 l/min	766 ... 2686 l/min	52 ... 1900 l/min
<b>Explosion prevention and protection</b>	II 2G, II 2D, for zones 1, 2, 21, 22, Ex t IIC T80°C Db, EPL Db (IEC-EX), Ex ia IIC T6 Ga, EPL Ga (IEC-EX)	II 2G, II 2D, for zones 1, 2, 21, 22, Ex ia IIC T85°C, T125°C Db, EPL Db (IEC-EX), EPL Db (KR), Ex ia IIC T6, T5 Gb, EPL Gb (IEC-EX), EPL Gb (KR)	For zones 1, 2, 21, 22
<b>Description</b>	<ul style="list-style-type: none"> <li>• Connection pattern to NAMUR to VDI/VDE 3845</li> <li>• Rotatable seal for 3/2-way or 5/2-way valve</li> <li>• Wide choice of EX solenoid systems</li> <li>• Sturdy and powerful</li> <li>• Extended temperature range</li> <li>• Outstanding value for money</li> <li>• All solenoid coils can be used on an armature tube</li> <li>• The VSNC...FN variant achieves higher energy efficiency with reduced power consumption</li> </ul>	<ul style="list-style-type: none"> <li>• Suitable for process automation, for applications in chemical and petrochemical plants</li> <li>• Suitable for outdoor use under harsh ambient conditions</li> <li>• Especially suitable for quarter turn actuators thanks to NAMUR flange pattern</li> <li>• Valve can switch between internal and external pilot air</li> <li>• Variants with TÜV approval up to SIL3 to IEC 61508</li> </ul>	<ul style="list-style-type: none"> <li>• Suitable for process automation, for applications in chemical and petrochemical plants</li> <li>• Suitable for outdoor use under harsh ambient conditions</li> <li>• Especially suitable for quarter turn actuators thanks to NAMUR flange pattern</li> <li>• Variants with TÜV approval up to SIL3 to IEC 61508</li> </ul>
<b>→ Page/online</b>	102	<a href="#">vofc</a>	<a href="#">vofd</a>

## Accessories for valves

	 <b>Solenoid coils VACC-S13-18-K4-...-EX4ME</b>
<b>Electrical connection</b>	Terminal box, cable entry thread M20x1.5
<b>Characteristic coil data</b>	24 V DC: 1.8 W, 24 V AC: 40/65 Hz, power 1.8 VA, 60 V AC: 40/65 Hz, power 1.8 VA, 60 V DC: 1.8 W, 110 V DC: 1.8 W, 110 V AC: 40/65 Hz, power 1.8 VA, 230 V DC: 1.8 W, 230 V AC: 1.8 W
<b>Degree of protection</b>	IP65
<b>Description</b>	<ul style="list-style-type: none"> <li>• To EU Explosion Protection Directive (ATEX)</li> <li>• Compatible with solenoid valves VOFC, VOFD, with 13 mm armature tube</li> <li>• With encapsulation, enhanced safety</li> <li>• Variant with internal fuse</li> </ul>
<b>→ Page/online</b>	216

## Product overview

### Sensor boxes



	 <b>Sensor boxes SRBC</b>	 <b>Sensor boxes SRBG</b>	 <b>Sensor boxes SRBE</b>
<b>Information on materials - housing</b>	Die-cast aluminium	PBT	Die-cast aluminium
<b>Operating voltage range AC</b>	0 ... 250 V		0 ... 250 V
<b>Operating voltage range DC</b>	0 ... 175 V	6 ... 60 V	0 ... 60 V
<b>Measuring principle</b>		Inductive	Inductive, magnetic reed, mechanical/electrical, for proximity sensor
<b>Switching element function</b>	N/C contact, N/O contact, toggle switch, single-pole	N/C contact, N/C contact or N/O contact, switchable, N/O contact	N/C contact, N/O contact, toggle switch, single-pole, toggle switch, double-pole
<b>Description</b>	<ul style="list-style-type: none"> <li>• Pre-assembled mounting adapter for ease of installation</li> <li>• Trip cams can be set easily without additional tools</li> <li>• Sturdy, corrosion-resistant design, ideal for use in harsh ambient conditions</li> <li>• Clearly visible 3D position indicator allows rapid detection of the current position of the quarter turn actuator</li> </ul>	<ul style="list-style-type: none"> <li>• Compact housing with M12 plug connection</li> <li>• Direct mounting on quarter turn actuators to VDI/VDE 3845</li> <li>• AS-Interface version with extended addressing</li> <li>• Intrinsically safe version to ATEX and SIL 2 to IEC 61508</li> </ul>	<ul style="list-style-type: none"> <li>• Trip cams can be set easily without additional tools</li> <li>• Sturdy, corrosion-resistant design, ideal for use in harsh ambient conditions</li> <li>• Clearly visible 3D position indicator allows rapid detection of the current position of the quarter turn actuator</li> </ul>
<b>→ Page/online</b>	205	<a href="#">srbg</a>	<a href="#">srbe</a>

### Positioners



	 <b>Positioners CMSX</b>
<b>Standard nominal flow rate</b>	50 ... 130 l/min
<b>Ambient temperature</b>	-5 ... 60°C
<b>Reference value</b>	0 - 20 mA, 4 - 20 mA, 0 - 10
<b>Operating voltage range DC</b>	21.6 ... 26.4 V
<b>Operating pressure</b>	3 ... 8 bar
<b>Safety information</b>	Safety position: in the case of a broken cable or operating voltage failure, the regulating action is to hold. Safety position: in the case of a broken cable or an operating voltage failure, the regulating action is opening/closing.
<b>Degree of protection</b>	IP65
<b>Type of mounting</b>	Via accessories, on flange ISO 5211
<b>Information on housing materials</b>	PC
<b>Description</b>	<ul style="list-style-type: none"> <li>• Digital electropneumatic positioner for single-acting or double-acting pneumatic quarter turn actuators and double-acting pneumatic linear actuators</li> <li>• No air consumption in the regulated state</li> </ul>
<b>→ Page/online</b>	207



## Linear actuators



	 Copac linear actuators DLP	 Linear actuators with displacement encoder DFPI-NB3	 Linear actuators with displacement encoder DFPI
<b>Design</b>	Piston rod	Piston, piston rod, tie rod, cylinder barrel	Piston, piston rod, profile barrel, tie rod, cylinder barrel
<b>Mode of operation</b>	Double-acting	Double-acting	Double-acting
<b>Size of valve actuator</b>	80, 100, 125, 160, 200, 250, 320	100, 125, 160, 200, 250, 320	100, 125, 160, 200, 250, 320
<b>Stroke</b>	40 ... 600 mm	40 ... 990 mm	40 ... 990 mm
<b>Operating pressure</b>	2 ... 8 bar	3 ... 8 bar	3 ... 8 bar
<b>Ambient temperature</b>	-20 ... 80°C	-20 ... 80°C	-20 ... 80°C
<b>Description</b>	<ul style="list-style-type: none"> <li>• Mounting interfaces for process valves to DIN EN ISO 5210</li> <li>• Connection pattern to NAMUR to VDI/VDE 3845</li> <li>• Integrated air supply</li> <li>• ATEX certification</li> </ul>	<ul style="list-style-type: none"> <li>• Mounting interfaces to ISO 15552</li> <li>• Sturdy tie rod design</li> <li>• Optionally with integrated displacement encoder or fully integrated positioner</li> <li>• IP65, IP67, IP69K, NEMA4</li> <li>• ATEX certification</li> </ul>	<ul style="list-style-type: none"> <li>• Mounting interfaces for process valves to DIN EN ISO 5210</li> <li>• Integrated air duct</li> <li>• Optionally with integrated displacement encoder or fully integrated positioner</li> <li>• IP65, IP67, IP69K, NEMA4</li> <li>• ATEX certification</li> </ul>
<b>→ Page/online</b>	<a href="#">dlp</a>	<a href="#">dfpi</a>	<a href="#">dfpi</a>

## Quarter turn actuators



	 Quarter turn actuators DAPS	 Quarter turn actuators DFPD
<b>Design</b>	Scotch yoke system	Rack and pinion
<b>Mode of operation</b>	Double-acting, single-acting	Double-acting, single-acting
<b>Size of valve actuator</b>	0008, 0015, 0030, 0053, 0060, 0090, 0106, 0120, 0180, 0240, 0360, 0480, 0720, 0960, 1440, 1920, 2880, 3840, 4000, 5760, 8000	10, 20, 40, 80, 120, 160, 240, 300, 480, 700, 900, 1200, 2300
<b>Flange hole pattern</b>	F03, F04, F05, F07, F10, F12, F14, F16, F25	F03, F04, F05, F07, F10, F12, F14, F16, F0507, F0710, F1012, F1216
<b>Swivel angle</b>	90°, 92°	90°, 120°, 135°, 180°
<b>Ambient temperature</b>	-50 ... 150°C	-50 ... 150°C
<b>Operating pressure</b>	1 ... 8.4 bar	2 ... 8 bar
<b>Description</b>	<ul style="list-style-type: none"> <li>• High breakaway torques</li> <li>• Approved in accordance with Directive 2014/34/EU (ATEX)</li> <li>• Flange hole pattern to ISO 5211</li> <li>• Mounting hole pattern to VDI/VDE 3845</li> <li>• Available with handwheel as a manual emergency override</li> <li>• Corrosion-resistant version made from stainless steel</li> </ul>	<ul style="list-style-type: none"> <li>• Constant torque across the entire rotation angle range of 90° with the double-acting version</li> <li>• Process valve connection to ISO 5211</li> <li>• Mounting hole pattern to VDI/VDE 3845</li> <li>• Sturdy, non-slip and easy-to-clean aluminium housing</li> <li>• Long service life, low wear</li> <li>• Version with swivel angle 120°, 135°, 180° for the sizes 40, 120, 240, 480, double-acting</li> </ul>
<b>→ Page/online</b>	<a href="#">daps</a>	<a href="#">209</a>

Product overview





Ball valves and ball valve units

	 Ball valves VZBD	 Ball valves VZBE	 Ball valves VZBF
<b>Design</b>	2-way ball valve	2-way ball valve, 3-way ball valve, L-shaped hole, T-shaped hole	2-way ball valve
<b>Actuation type</b>	Mechanical	Mechanical	Mechanical
<b>Nominal width DN</b>	15, 20, 25, 32, 40, 50, 65, 80, 100	8, 10, 15, 20, 25, 32, 40, 50, 65, 80, 100	15, 20, 25, 32, 40, 50, 65, 80, 100, 150, 200
<b>Process valve connection</b>	Clamp to ASME-BPE, clamp to DIN 32676 series B, weld-on end to ASME-BPE, weld-on end to ISO 1127	1 NPT, 1 1/2 NPT, 1 1/4 NPT, 1/2 NPT, 1/4 NPT, 2 NPT, 2 1/2 NPT, 3 NPT, 3/4 NPT, 3/8 NPT, 4 NPT	Flange to ANSI B16.5 class 150
<b>Flow rate Kv</b>	3.5 ... 436.3 m <sup>3</sup> /h	5 ... 435.2 m <sup>3</sup> /h	8.5 ... 2078.3 m <sup>3</sup> /h
<b>Temperature of medium</b>	-20 ... 200°C	-20 ... 200°C	-20 ... 200°C
<b>Process valve PN nominal pressure</b>	16	63	20
<b>Description</b>	<ul style="list-style-type: none"> <li>• Electro-polished surfaces SFV4</li> <li>• PTFE seal with minimal dead space</li> <li>• The powerful ball valve for the pharmaceutical and cosmetic industries</li> <li>• FDA-compliant seal to FDA 21 CFR 177.1550</li> </ul>	<ul style="list-style-type: none"> <li>• 2-way manual, optionally with lockable hand lever</li> <li>• 3-way, L-shaped or T-shaped hole, optionally with lockable hand lever</li> <li>• Stainless steel design</li> <li>• Pipe thread to ASME B1.20.1</li> </ul>	<ul style="list-style-type: none"> <li>• Flanged connections to ANSI B 16.5. class 150</li> <li>• Static discharge ensured</li> <li>• API 607 Fire Safe approval</li> <li>• Easy to service</li> </ul>
<b>→ Page/online</b>	<a href="#">vzbd</a>	<a href="#">vzbe</a>	<a href="#">vzbf</a>

Ball valves and ball valve units



	 Ball valves VZBM	 Ball valve actuator units VZBM	 Ball valves QH
<b>Design</b>	2-way ball valve, 3-way ball valve, L-shaped hole, T-shaped hole	2-way ball valve, 3-way ball valve, quarter turn actuator	Ball valve
<b>Actuation type</b>	Mechanical	Pneumatic	Manual
<b>Nominal width DN</b>	8, 10, 15, 20, 25, 32, 40, 50	8, 10, 15, 20, 25, 32, 40, 50	
<b>Process valve connection</b>	Rp1, Rp1 1/2, Rp1 1/4, Rp1/2, Rp1/4, Rp2, Rp3/4, Rp3/8	Rp1, Rp1 1/2, Rp1 1/4, Rp1/2, Rp1/4, Rp2, Rp3/4, Rp3/8	
<b>Flow rate Kv</b>	5.9 ... 243 m <sup>3</sup> /h	5.9 ... 243 m <sup>3</sup> /h	
<b>Temperature of medium</b>	-20 ... 130°C	-20 ... 130°C	
<b>Process valve PN nominal pressure</b>	25, 40, 50	25, 40	30
<b>Description</b>	<ul style="list-style-type: none"> <li>• Brass design</li> <li>• Pipe thread to EN 10226-1</li> </ul>	<ul style="list-style-type: none"> <li>• Ball valve actuator unit with double-acting or single-acting quarter turn actuator DFPD</li> <li>• Brass ball valve</li> <li>• 2-way ball valve actuator unit with pipe thread to EN 10226-1</li> <li>• 3-way ball valve actuator unit with L-shaped hole and pipe thread to EN 10226-1</li> <li>• 3-way ball valve actuator unit with T-shaped hole and pipe thread to EN 10226-1</li> <li>• Flow is fully opened or closed in both directions</li> </ul>	<ul style="list-style-type: none"> <li>• Shut-off valve, manually operated</li> <li>• In-line installation</li> <li>• Female thread at both ends</li> <li>• With hand lever</li> <li>• Pipe thread to ISO 2281</li> </ul>
<b>→ Page/online</b>	<a href="#">vzbm</a>	<a href="#">vzbm</a>	<a href="#">qh</a>

## Ball valves and ball valve units



	 Ball valves VZBC	 Ball valve actuator units VZBC	 Ball valves VZBA	 Ball valve actuator units VZBA
<b>Design</b>	2-way ball valve	2-way ball valve, quarter turn actuator	2-way ball valve, 3-way ball valve, L-shaped hole, T-shaped hole	2-way ball valve, 3-way ball valve, L-shaped hole, quarter turn actuator, T-shaped hole
<b>Actuation type</b>	Mechanical	Pneumatic	Mechanical	Pneumatic
<b>Nominal width DN</b>	15, 20, 25, 32, 40, 50, 65, 80, 100	15, 20, 25, 32, 40, 50, 65, 80, 100	8, 10, 15, 20, 25, 32, 40, 50, 65, 80, 100	8, 10, 15, 20, 25, 32, 40, 50, 65, 80, 100
<b>Process valve connection</b>	Ring housing with threaded flange	Ring housing with threaded flange	Weld-on ends/weld-on ends, Rp1, Rp1 1/2, Rp1 1/4, Rp1/2, Rp1/4, Rp2, Rp2 1/2, Rp3, Rp3/4, Rp3/8, Rp4	Weld-on ends/weld-on ends, Rp1, Rp1 1/2, Rp1 1/4, Rp1/2, Rp1/4, Rp2, Rp2 1/2, Rp3, Rp3/4, Rp3/8, Rp4
<b>Flow rate Kv</b>	19.4 ... 1414 m <sup>3</sup> /h	19.4 ... 1414 m <sup>3</sup> /h	7 ... 1414 m <sup>3</sup> /h	7 ... 1414 m <sup>3</sup> /h
<b>Temperature of medium</b>	-10 ... 200°C	-10 ... 200°C	-10 ... 200°C	-10 ... 200°C
<b>Process valve PN nominal pressure</b>	16, 40	16, 40	63	63
<b>Description</b>	<ul style="list-style-type: none"> <li>• Automatable 2-way compact flanged ball valve</li> <li>• Stainless steel design</li> <li>• Short installation length</li> <li>• Blow-out proof shaft</li> <li>• Manual operation possible using hand lever</li> <li>• Flange to DIN 1092-1</li> <li>• Mounting flange to ISO 5211</li> <li>• Use in zones 1, 21, 2, 22</li> </ul>	<ul style="list-style-type: none"> <li>• Ball valve actuator unit with double-acting or single-acting quarter turn actuator DAPS</li> <li>• Stainless steel ball valve in compact design</li> <li>• Connection pattern to NAMUR for solenoid valves/sensor boxes to VDI/VDE 3845</li> <li>• Flow is fully opened or closed in both directions</li> <li>• Use in zones 1, 21, 2, 22</li> </ul>	<ul style="list-style-type: none"> <li>• Automatable 2-way or 3-way ball valve</li> <li>• Stainless steel design</li> <li>• Blow-out proof shaft</li> <li>• Manual operation possible using hand lever</li> <li>• Connecting thread to EN 10226-1</li> <li>• Mounting flange to ISO 5211</li> <li>• Use in zones 1, 21, 2, 22</li> </ul>	<ul style="list-style-type: none"> <li>• Ball valve actuator unit with double-acting or single-acting quarter turn actuator DAPS</li> <li>• Stainless steel ball valve</li> <li>• Connection pattern to NAMUR for solenoid valves/sensor boxes to VDI/VDE 3845</li> <li>• Flow is fully opened or closed in both directions</li> <li>• Use in zones 1, 21, 2, 22</li> </ul>
<b>→ Page/online</b>	<a href="#">vzbc</a>	<a href="#">vzbc</a>	<a href="#">vzba</a>	<a href="#">vzba</a>

Product overview



Angle seat valves

	 <b>Angle seat valves VZXF</b>	 <b>Angle seat valves VZXA</b>
<b>Actuator size</b>		46 mm, 75 mm, 90 mm
<b>Design</b>	Poppet valve with piston actuator	Poppet valve with piston actuator, poppet valve with diaphragm actuator
<b>Valve function</b>	2/2-way, closed, monostable	2/2
<b>Control function</b>		Closed by reduced spring force, NC, double-acting, opened by spring force, NO, closed by spring force, NC
<b>Actuation type</b>	Pneumatic	Pneumatic
<b>Nominal width</b>	12 ... 45 mm	
<b>Flow rate Kv</b>	3.3 ... 43 m <sup>3</sup> /h	6 ... 68.5 m <sup>3</sup> /h
<b>Medium pressure</b>	-0.9 ... 40 bar	0 ... 30 bar
<b>Temperature of medium</b>	-40 ... 200°C	-10 ... 180°C
<b>Process valve PN nominal pressure</b>	16, 40	
<b>Description</b>	<ul style="list-style-type: none"> <li>Sturdy design</li> <li>Stainless steel and gunmetal (red brass) process valves with stainless steel, brass or aluminium actuators</li> <li>Safety position "closing"</li> <li>Different actuator sizes and housing materials</li> <li>Selection of different seat and shaft seals</li> <li>Flow direction is freely selectable</li> <li>For liquids, gases and other easily contaminated media</li> <li>Easy-to-clean design</li> </ul>	<ul style="list-style-type: none"> <li>Highly flexible, extremely high flow rates</li> <li>Long service life</li> <li>Modular design</li> <li>Hygienic design, insensitive to dirt</li> <li>Quick and easy maintenance</li> <li>Simple and sturdy: an ideal choice for virtually all media with a viscosity of up to 600 mm<sup>2</sup>/s</li> <li>High chemical and thermal resistance</li> </ul>
<b>→ Page/online</b>	<b>211</b>	<b>VZxa</b>

Solenoid actuated media valves

	 <b>Solenoid valves VZWD</b>	 <b>Solenoid valves VZWF</b>	 <b>Solenoid valves VZWM</b>
<b>Design</b>	Directly actuated poppet valve	Diaphragm valve, force pilot operated	Poppet valve with diaphragm seal
<b>Actuation type</b>	Electrical	Electrical	Electrical
<b>Nominal width</b>	1 ... 6 mm	13.5 ... 50 mm	13 ... 50 mm
<b>Process valve connection</b>	1/4 NPT, 1/8 NPT, G1/4, G1/8, NPT1/4	1 NPT, 1 1/2 NPT, 1 1/4 NPT, 1/2 NPT, 1/4 NPT, 2 NPT, 3/4 NPT, 3/8 NPT, G1, G1 1/2, G1 1/4, G1/2, G1/4, G2, G3/4, G3/8, NPT1, NPT1 1/2, NPT1 1/4, NPT1/2, NPT1/4, NPT2, NPT3/4, NPT3/8	G1, G1 1/2, G1 1/4, G1/2, G1/4, G2, G3/4, G3/8
<b>Flow rate Kv</b>	0.06 ... 430 l/min	1.8 ... 29900 l/min	1.6 ... 31000 l/min
<b>Medium pressure</b>	0 ... 90 bar	0 ... 10 bar	0.5 ... 10 bar
<b>Temperature of medium</b>	-10 ... 80°C	-10 ... 80°C	-10 ... 60°C
<b>Description</b>	<ul style="list-style-type: none"> <li>Extensive pressure range</li> <li>Directly actuated poppet valve</li> <li>No pressure difference required</li> <li>Can also be used in vacuum technology</li> </ul>	<ul style="list-style-type: none"> <li>High flow rates</li> <li>Large nominal diameters with relatively small solenoids</li> <li>No pressure difference required</li> <li>Can also be used in vacuum technology</li> </ul>	<ul style="list-style-type: none"> <li>Brass or stainless steel casting design</li> <li>Electrical connection via solenoid armature tube</li> <li>Wide range of coils</li> <li>Coil can be ordered separately</li> </ul>
<b>→ Page/online</b>	<b>213</b>	<b>214</b>	<b>215</b>

## Solenoid actuated media valves

	 Solenoid valves VZWP	 Reverse jet pulse valves VZWE-E, VZWE-F
<b>Design</b>	Pilot-actuated piston poppet valve	Angled version, straight version with flange, diaphragm valve
<b>Actuation type</b>	Electrical	Electrical
<b>Nominal width</b>	13 ... 25 mm	20 ... 76 mm
<b>Process valve connection</b>	1 NPT, 1/2 NPT, 1/4 NPT, 3/4 NPT, 3/8 NPT, G1, G1/2, G1/4, G3/4, G3/8	G1, G1 1/2, G2, G2 1/2, G3/4, flange diameter 60, 75, 89
<b>Flow rate Kv</b>	1.5 ... 12250 l/min	15 ... 210 m3/h
<b>Medium pressure</b>	0.5 ... 40 bar	0.35 ... 8 bar
<b>Temperature of medium</b>	-10 ... 80°C	
<b>Description</b>	<ul style="list-style-type: none"> <li>• For all applications with a differential pressure of min. 0.5 bar</li> <li>• For high pressures and high flow rates with relatively small solenoids</li> <li>• For controlling gaseous and liquid media in open circuits</li> </ul>	<ul style="list-style-type: none"> <li>• High flow rates</li> <li>• For mechanically cleaning filters and dust filter systems</li> <li>• Fast opening and closing times</li> <li>• Sturdy pilot system</li> </ul>
<b>→ Page/online</b>	<a href="#">vzwp</a>	<a href="#">vzwe</a>

## Pneumatically actuated media valves

	 Pinch valves VZQA
<b>Design</b>	Pinch valve, pneumatically actuated
<b>Actuation type</b>	Pneumatic
<b>Nominal width DN</b>	6, 15, 25
<b>Process valve connection</b>	Clamp to ASME-BPE type A, clamp to ASME-BPE type B, clamp to DIN 32676 series A, 1 NPT, 1/2 NPT, 1/4 NPT, G1, G1/2, G1/4
<b>Flow rate Kv</b>	0.7 ... 18 m3/h
<b>Medium pressure</b>	0 ... 6 bar
<b>Temperature of medium</b>	-15 ... 150°C
<b>Valve function</b>	10
<b>Description</b>	<ul style="list-style-type: none"> <li>• Modular design</li> <li>• Quick and easy replacement of the diaphragm</li> <li>• Selection of different materials for housing and connection caps</li> <li>• Different connection cap designs (G and NPT thread), clamp ferrule to DIN 32676 and ASME-BPE</li> <li>• For critical, abrasive and viscous media</li> <li>• Up to 2 million switching cycles</li> <li>• FDA-compliant materials</li> <li>• Easy-to-clean design</li> <li>• Flow direction is freely selectable</li> </ul>
<b>→ Page/online</b>	<a href="#">vzqa</a>

Product overview

Filter regulators: Individual devices



Filter regulators  
PCRP

<b>Pneumatic connection 1</b>	G1/2, G1/4, NPT1/2-14, NPT1/4-18
<b>Standard nominal flow rate</b>	1920 ... 4115 l/min
<b>Pressure regulation range</b>	0.5 ... 12 bar
<b>Operating pressure</b>	1 ... 20 bar
<b>Grade of filtration</b>	5 µm, 40 µm
<b>Description</b>	<ul style="list-style-type: none"> <li>• Robust housing for the specific requirements of process automation</li> <li>• Suitable for use outdoors and at temperatures down to -60 °C</li> <li>• Resistant to UV radiation and corrosive environments</li> <li>• With manual condensate drain, rotating</li> <li>• Size 64</li> </ul>
<b>→ Page/online</b>	<a href="#">pcrp</a>



- Measuring principle: electromagnetic, magnetic reed or inductive
  - Switching element function: toggle switch, single-pole (SPDT)
  - For DC and AC voltage
  - Pre-assembled mounting bridge
  - Cable connector and blanking plug included in the scope of delivery
  - Selected types in accordance with ATEX directive for potentially explosive atmospheres
- [www.festo.com/ex](http://www.festo.com/ex)

## Order code

001	002	003	004	005	006	007	008	009	010	011
SRBC	C	A3	YR	90				C2	P20	

Legend:  Mandatory entry  Optional entry

001	Type
SRBC	Limit switch attachment
002	Design
C	Sensor box
003	Mechanical interface
A3	Mounting adapter, hole pattern 30x80 mm, shaft height 20 mm
004	Display type
YR	Position indicator yellow/red
005	Measuring range
90	0 ... 90°
006	Sensor principle
N	Proximity sensor, inductive
MW	Floating contact, changeover switch

007	Nominal operating voltage
22A	250 V AC
20N	8.2 V DC, NAMUR
1	24 V DC
008	Electrical output
1W	1-pin toggle switch
ZC	2-wire N/C contact
P	PNP
009	Electrical connection
C2	Screw terminal
010	Cable connector
P20	M20x1.5, polymer
011	EU certification
-	None
EX6	II 1 GD

## Product options

Sensor principle  
R Reed with contact

Nominal operating voltage  
2A 110 V AC, 50-60 Hz

Electrical output  
ZU 2-wire N/O contact  
N NPN



Configurable product

This product and all its product options can be ordered online via the configurator:

→ [www.festo.com/catalogue/srbc](http://www.festo.com/catalogue/srbc)

## Ordering

Electromechanical and magnetic reed		
	Type	Part no.
006	Floating contact, changeover switch	
007	250 V AC	SRBC-CA3-YR90-MW-22A-1W-C2P20 ★ 3482805

Inductive		
	Type	Part no.
006	Proximity sensor, inductive	
007	8.2 V DC, NAMUR	SRBC-CA3-YR90-N-20N-ZC-C2P20-EX6 ★ 3482807
011	II2GD	
007	24 V DC	SRBC-CA3-YR90-N-1-P-C2P20 ★ 3482808

Sensor boxes SRBC ★

Accessories

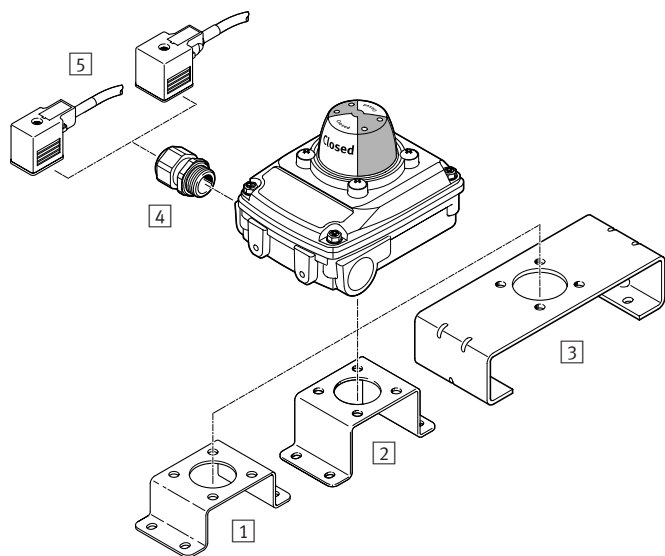

- 1) Mounting flange adapter for mounting on standards-based actuators to VDI/VDE 3845 DARQ-K-X1-A1-F05-20-R1<sup>1)</sup> → 206
- 2) Mounting flange adapter for mounting on standards-based actuators to VDI/VDE 3845 DARQ-K-X1-A1-F05-30-R1 → 206
- 3) Mounting flange adapter for mounting on standards-based actuators to VDI/VDE 3845 DARQ-K-X1-A2-F05-30-R1 → 206
- 4) Cable connector NETC-P-M20<sup>1)</sup> → [srbc](#)
- 5) Connecting cables for valve connection for sensor box with terminal rail connection NEBV → [srbc](#)

1) Included in the scope of delivery of the sensor box.

1) Mounting flange adapter DARQ-K-X1-A1-F05-20-R1				
	Actuator outlet hole pattern	Size	Type	Part no.
For mounting sensor boxes on standards-based actuators to VDI/VDE 3845				
	30x80 mm	20	DARQ-K-X1-A1-F05-20-R1	3636269

3) Mounting flange adapter DARQ-K-X1-A1-F05-20-R1				
	Actuator outlet hole pattern	Size	Type	Part no.
For mounting sensor boxes on standards-based actuators to VDI/VDE 3845				
	30x130 mm	30	DARQ-K-X1-A2-F05-30-R1	3886114

2) Mounting flange adapter DARQ-K-X1-A1-F05-30-R1				
	Actuator outlet hole pattern	Size	Type	Part no.
For mounting sensor boxes on standards-based actuators to VDI/VDE 3845				
	30x80 mm	30	DARQ-K-X1-A1-F05-30-R1	3636270





- Positioners for single-acting and double-acting pneumatic quarter turn actuators and double-acting linear actuators in process automation systems
- High process reliability thanks to analogue and digital feedback signals
- The end position can be flexibly defined via the freely configurable analogue signal
- Very energy-efficient: no compressed air consumption at standstill
- For automated butterfly valves, ball valves, bulk goods deflectors, etc.

## Order code

001	002	003	004	005	006	007	008	009
CMSX	P		C	U	F1			A

Legend:  Mandatory entry

001	Type
CMSX	Positioner, for process automation
002	Product version
P	Primarily polymers
003	Design
S	Positioner, integrated displacement/angle measurement
SE	Positioner, external displacement/angle measurement
004	Display type
C	LCD, backlit
005	Setpoint value
U	Configurable (0 ... 10 V, 0 ... 20 mA, 4 ... 20 mA)

006	Position feedback
F1	4 ... 20 mA
007	Function
D	Double-acting
S	Single-acting
008	Flow rate
50	50 l/min
130	130 l/min
009	Safety function
A	Opening or closing in the event of a system crash <sup>1)</sup>

1) Failure of the operating voltage supply or the setpoint specification.

## Product options

### Safety function

C Maintain position in the event of system failure<sup>1)</sup>

1) Failure of the operating voltage supply or the setpoint specification.



### Configurable product

This product and all its product options can be ordered online via the configurator:

→ [www.festo.com/catalogue/cmsx](http://www.festo.com/catalogue/cmsx)

## Ordering

Suitable for <sup>1)</sup>					Safety position	Type	Part no.	
Quarter turn actuators DAPS → <a href="#">daps</a>		Quarter turn actuators DFPD → 209		Linear actuators DFPI → <a href="#">dfpi</a>	Can be set to open or close in the event of system failure <sup>2)</sup>	CMSX-P-S-C-U-F1-S-50-A	★ 3929370	
Single-acting	Double-acting	Single-acting	Double-acting	CMSX-P-S-C-U-F1-D-50-A				★ 3929313
				CMSX-P-SE-C-U-F1-D-130-A				★ 3929539
Size								
≥0053	–	≥0040	–	–				
–	≥0060	–	≥0040	–				
–	–	–	–	100 ... 320				

1) The precise selection of the positioner for the actuator is dependent on the specific application. Only rough reference values are specified here.

2) Failure of the operating voltage supply or the setpoint specification.

Positioners CMSX ★

Accessories

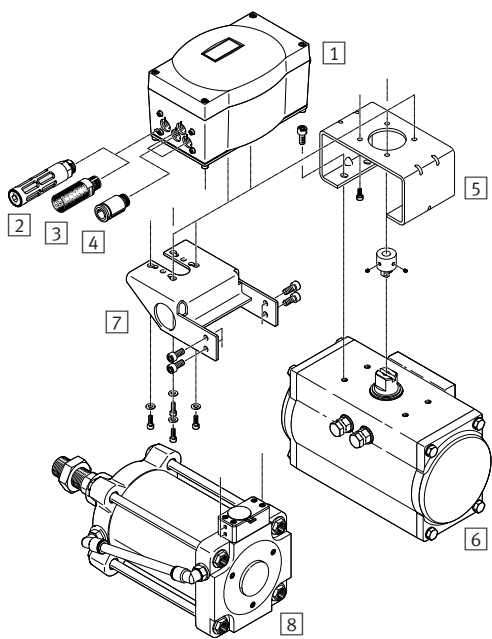

- 1 Positioner CMSX → 207
- 2 Silencer U, polymer, male thread → 192
- 3 Silencer UC, for reducing noise at valve exhaust ports → [uc](#)
- 4 Push-in fitting QS → 168
- 5 Mounting flange adapter DARQ for mounting on standards-based actuators to VDI/VDE 3845 → 208
- 6 Quarter turn actuator DFPD → 209
- 7 Adapter kit DADG, for direct mounting of a positioner on the actuator → [dadg](#)
- 8 Linear actuator DFPI → [dfpi](#)

5 Mounting flange adapter DARQ

	Actuator outlet hole pattern	Size	Type	Part no.
For mounting positioner CMSX on standards-based actuators to VDI/VDE 3845				
	30x80 mm	20	DARQ-K-P-A1-F05-20-R1	★ 2197135
	30x80 mm	30	DARQ-K-P-A1-F05-30-R1	★ 2197136
	30x130 mm	30	DARQ-K-P-A2-F05-30-R1	2197137

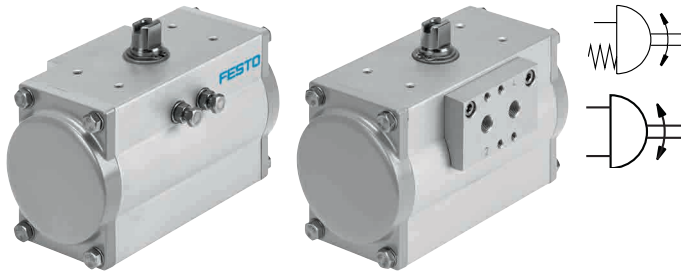

- Size 10 ... 2300
- Torque 10 ... 2300 Nm
- Swivel angle 90°, 120°, 135°, 180°
- Flange hole pattern to ISO 5211
- Connection pattern to NAMUR for solenoid valves/sensor boxes to VDI/VDE 3845

- Suitable for the automation of butterfly valves, ball valves and air dampers
- Also suitable for water/wastewater, beverage and pharmaceutical industries as well as process automation

## Order code – Basic design

001	002	003	004	005	006	007	008	009	010	011	012	013	014	015	016
DFPD				RP		90	R	D							

001	Type
DFPD	Quarter turn actuator
002	System of units
–	Metric
003	Version
–	Standard
004	Size
10	10
20	20
40	40
80	80
120	120
005	Design
RP	Rack and pinion
006	Yoke type
–	Without
007	Swivel angle
90	90°
008	Swivel direction
R	To the right

009	Function
D	Double-acting
010	Spring configuration
–	Without
011	Flange pattern 1
F03	Hole pattern F03
F04	Hole pattern F04
F05	Hole pattern F05
012	Flange pattern 2
–	None
07	Hole pattern F07
013	Manual override
–	None
014	Temperature range
–	Standard
015	Shaft material
–	Standard
016	Housing surface treatment
–	Without

Legend:  Mandatory entry  Optional entry

## Product options

DFPD-C series is suitable for the harsh conditions in the chemical industry

DFPD-HD Heavy-duty quarter turn actuator

Size

- 160, 240, 300, 480, 700, 900, 1200, 2300

Function

- Single-acting

System of units

- Imperial

Swivel angle

- 0 ... 180°

Swivel direction

- To the left

Spring configuration

- For connection pressure 2 ... 5.5 bar
- For connection pressure 6 bar

Flange pattern

Hole pattern F07, F10, F12, F14, F16

Temperature range

- 0 ... +150° C
- –50 ... +60° C

Shaft material

- Stainless steel

Housing surface treatment

- Epoxy-coated



Configurable product

This product and all its product options can be ordered online via the configurator:

→ [www.festo.com/catalogue/dfpd](http://www.festo.com/catalogue/dfpd)

Actuators >

Quarter turn actuators DFPD ★

Ordering – Basic design

004 Size	Type	Part no.
Quarter turn actuators DFPD, double-acting		
10	DFPD-10-RP-90-RD-F03	★ 8047613
20	DFPD-20-RP-90-RD-F04	★ 8047614
40	DFPD-40-RP-90-RD-F0507	★ 8047615
80	DFPD-80-RP-90-RD-F0507	★ 8047616
120	DFPD-120-RP-90-RD-F0507	★ 8048123

Accessories

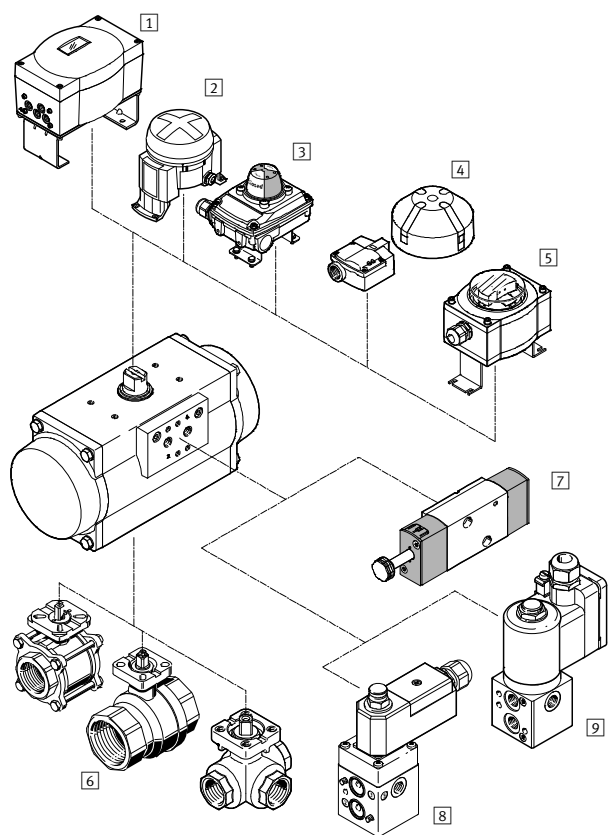

- 1 Positioner CMSX → 207
- 2 Limit switch attachment DAPZ → [dapz](#)
- 3 Sensor box SRBC → 205
- 4 Sensor box SRBG → [srbg](#)
- 5 Sensor box SRAP → [srap](#)
- 6 Ball valve VAPB → [vapb](#)  
Ball valve VZBA → [vzba](#)
- 7 Solenoid valve VSNC → 102
- 8 Solenoid valve VOFC → [vofc](#)
- 9 Solenoid valve VOFD → [vofd](#)

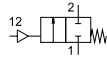

- Angle seat valves made of gunmetal (red brass) and stainless steel, fully assembled and directly actuated by compressed air supply
  - Suitable for use with lightly contaminated media
  - Can be used for steam applications
  - Direct pilot air supply
  - Selected types in accordance with ATEX directive for potentially explosive atmospheres
- [www.festo.com/ex](http://www.festo.com/ex)

## Order code – Basic design

001	002	003	004	005	006	007	008	009	010	011	012	013	014	015
VZXF	L	M22C	M	B							50			

001	Type		
VZXF	Angle seat valve, externally actuated		
002	Type of directional control valve		
L	In-line valve		
003	Valve function		
M22C	2/2-way valve, normally closed		
004	Reset method for monostable valves		
M	Mechanical spring		
005	Flow direction		
B	Under valve seat, for gaseous and liquid media		
006	Process valve connection		
G12	Thread G1/2		
G34	Thread G3/4		
G1	Thread G1		
007	Nominal width DN		
120	12 mm	180	18 mm
130	13 mm	230	23 mm
160	16 mm	240	24 mm
008	Temperature of medium		
–	Standard, –10 ... 80 °C		
M1	–40 ... 200 °C		

009	Valve housing material
H3	Gunmetal (red brass)
V4	Stainless steel
010	Actuator housing material
B1	Brass
V4	Stainless steel
011	Spindle seal material
–	Standard, NBR
T	PTFE
012	Actuator size
50	50 mm
013	Medium pressure
10	0 ... 10 bar
16	0 ... 16 bar
20	0 ... 20 bar
40	0 ... 40 bar
014	Presence of PWIS <sup>1)</sup>
–	Standard
015	EU certification
–	None

1) PWIS: paint-wetting impairment substances

Legend:  Mandatory entry  Optional entry

## Product options

### Process valve connection

- G11/4, G11/2, G2

### Sealing material

- FPM

### Actuator housing material

- Nickel-plated brass
- Aluminium
- Nickel-plated aluminium

### Flow direction

- Over valve seat, for gaseous media

### Actuator size

- 80 mm

### Nominal width

- 29 ... 45 mm

### Medium pressure

- Max. 3 ... 25 bar
- –0.9 ... 0 bar
- Max. 22 bar

### Presence of PWIS

- Free of PWIS

### EU certification

- II 2GD

Process valves >

Angle seat valves VZXF ★

Ordering – Product options



Configurable product

This product and all its product options can be ordered online via the configurator:

→ [www.festo.com/catalogue/vzxf](http://www.festo.com/catalogue/vzxf)

Ordering – Basic design

006 Process valve connection	009 Valve housing material	010 Actuator housing material	008 Temperature of medium	Type	Part no.
<b>012 Actuator size 50 mm</b>					
G1/2	Gunmetal (red brass)	Brass	-10 ... +80 °C	VZXF-L-M22C-M-B-G12-120-H3B1-50-16	★ 1002501
G3/4	Gunmetal (red brass)	Brass	-10 ... +80 °C	VZXF-L-M22C-M-B-G34-160-H3B1-50-16	★ 1002503
G1	Gunmetal (red brass)	Brass	-10 ... +80 °C	VZXF-L-M22C-M-B-G1-230-H3B1-50-10	★ 1002505
G1/2	Stainless steel	Stainless steel	-40 ... +200 °C	VZXF-L-M22C-M-B-G12-130-M1-V4V4T-50-40	★ 1002513
G3/4	Stainless steel	Stainless steel	-40 ... +200 °C	VZXF-L-M22C-M-B-G34-180-M1-V4V4T-50-20	★ 1002515
G1	Stainless steel	Stainless steel	-40 ... +200 °C	VZXF-L-M22C-M-B-G1-240-M1-V4V4T-50-10	★ 1002517

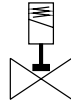

- Suitable for applications with high pressure and low flow rates
- Operating pressure 0 ... 90 bar
- Process valve PN 50 nominal pressure
- Flow rate Kv 0.06 ... 0.4 m<sup>3</sup>/h
- Solenoid actuation

## Order code – Basic design

001 002 003 004 005 006 007 008 009 010 011  
 VZWD - L - M22C - M - [ ] - [ ] - V - 1 P4 - [ ] - [ ]

Legend: [ ] Mandatory entry [ ] Optional entry

001	Type		
VZWD	Solenoid valve, directly actuated		
002	Valve type		
L	In-line valve		
003	Valve function		
M22C	2/2-way valve, normally closed, mechanical reset		
004	Reset method		
M	Mechanical spring		
005	Process valve connection		
G18	Thread G1/8		
G14	Thread G1/4		
006	Nominal width DN		
10	1 mm	40	4 mm
20	2 mm	60	6 mm
30	3 mm		

007	Sealing material
V	FPM
008	Nominal operating voltage
1	24 V DC
009	Electrical connection
P4	Plug socket, 3-pin
010	Medium pressure
4	Max. 4 bar
8	Max. 8 bar
15	Max. 15 bar
50	Max. 50 bar
011	Corrosion protection
-	Brass

## Product options

### Nominal width

- 1.5 mm
- 2.5 mm
- 5 mm

### Nominal operating voltage

- 110 V AC /50-60 Hz
- 230 V AC /50-60 Hz

### Medium pressure

- 5 ... max. 90 bar

### Corrosion protection

- Stainless steel



Configurable product

This product and all its product options can be ordered online via the configurator:

→ [www.festo.com/catalogue/vzwd](http://www.festo.com/catalogue/vzwd)

## Ordering – Basic design

005 Process valve connection	006 Nominal width DN	010 Medium pressure <sup>1)</sup>	Type	Part no.
008 Nominal operating voltage 24 V DC, 011 Corrosion protection: brass				
G1/8	1 mm	0 ... 50 bar	VZWD-L-M22C-M-G18-10-V-1P4-50	★ 1491825
	2 mm	0 ... 15 bar	VZWD-L-M22C-M-G18-20-V-1P4-15	★ 1491827
	3 mm	0 ... 15 bar	VZWD-L-M22C-M-G18-30-V-1P4-15	★ 1491836
	4 mm	0 ... 8 bar	VZWD-L-M22C-M-G18-40-V-1P4-8	★ 1491837
G1/4	3 mm	0 ... 15 bar	VZWD-L-M22C-M-G14-30-V-1P4-15	★ 1491844
	4 mm	0 ... 8 bar	VZWD-L-M22C-M-G14-40-V-1P4-8	★ 1491845
	6 mm	0 ... 4 bar	VZWD-L-M22C-M-G14-60-V-1P4-4	★ 1491847

1) The valves are suitable for vacuum with Pabs > 100 mbar. Please ensure the direction of flow corresponds to the direction of the arrow.

Process valves > Solenoid actuated media valves >

## Solenoid valves VZWF, force pilot operated ★

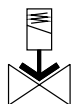

- Suitable for closed applications such as cooling or filling systems
- For control of gaseous and liquid media
- Medium pressure 0 bar or higher
- Process valve PN 40 nominal pressure
- Solenoid actuation

### Order code – Basic design

001 002 003 004 005 006 007 008 009 010 011  
**VZWF** - **B** - **L** - **M22C** - [ ] - [ ] - [ ] - **1** **P4** - [ ] - [ ]

Legend: [ ] Mandatory entry [ ] Optional entry

001	Type		
VZWF	Solenoid valve, force pilot operated		
002	Product version		
B	Optimised function		
003	Valve type		
L	In-line valve		
004	Valve function		
M22C	2/2-way valve, normally closed		
005	Process valve connection		
G14	Thread G1/4	G34	Thread G3/4
G38	Thread G3/8	G1	Thread G1
G12	Thread G1/2		

006	Nominal width DN
135	13.5 mm
275	27.5 mm
007	Material of sealing element
-	Standard (NBR)
008	Nominal operating voltage
1	24 V DC
009	Electrical connection
P4	Plug socket, 3-pin
010	Medium pressure
6	Max. 6 bar
10	Max. 10 bar
011	Corrosion protection
-	Standard (brass)

### Product options

Product version

- Standard

Nominal width DN

- 40 mm
- 50 mm

Nominal operating voltage

- 110 V AC/50-60Hz
- 230 V AC/50-60Hz

Corrosion protection

- Stainless steel

Process valve connection

- G1, G11/4, G11/2, G2

Sealing material

- EPDM

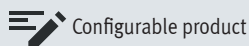

Configurable product

This product and all its product options can be ordered online via the configurator:

→ [www.festo.com/catalogue/vzwf](http://www.festo.com/catalogue/vzwf)

### Ordering – Basic design

005 Process valve connection	006 Nominal width DN	010 Medium pressure	Type	Part no.
008 Nominal operating voltage 24 V DC				
007 Material of sealing element NBR, 011 Standard corrosion protection				
G1/4	13.5 mm	0 ... 10 bar	VZWF-B-L-M22C-G14-135-1P4-10	★ 1492110
G3/8	13.5 mm	0 ... 10 bar	VZWF-B-L-M22C-G38-135-1P4-10	★ 1492111
G1/2	13.5 mm	0 ... 10 bar	VZWF-B-L-M22C-G12-135-1P4-10	★ 1492112
G3/4	27.5 mm	0 ... 6 bar	VZWF-B-L-M22C-G34-275-1P4-6	★ 1492113
G1	27.5 mm	0 ... 6 bar	VZWF-B-L-M22C-G1-275-1P4-6	★ 1492114



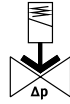
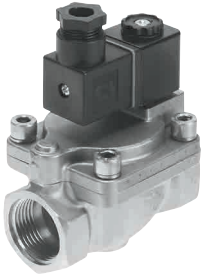

- Indirectly actuated poppet valve with diaphragm seal
- Flow rate 1400 ... 31000 l/min
- Wide range of coils

## Order code – Basic design

001	002	003	004	005	006
VZWM	L	M22C		F4	

Legend:  Mandatory entry  Optional entry

001	Type
VZWM	Solenoid valve, process directional control valve
002	Valve type
L	In-line valve
003	Valve function
M22C	2/2-way valve, normally closed

004	Process valve connection		
G14	Thread G1/4	G34	Thread G3/4
G38	Thread G3/8	G1	Thread G1
G12	Thread G1/2		
005	Electrical connection		
F4	With armature tube for solenoid coil MD-2- ... -PA		
006	Corrosion protection		
-	Standard (brass)		

## Product options

### Process valve connection

- G11/4, G11/2, G2

### Electrical connection

- With armature tube for solenoid coil MH-2- ... -PA

### Corrosion protection

- Stainless steel



Configurable product

This product and all its product options can be ordered online via the configurator:

→ [www.festo.com/catalogue/vzwm](http://www.festo.com/catalogue/vzwm)

## Ordering – Basic design

004 Process valve connection	Type	Part no.
	006 Standard corrosion protection	
G1/4	VZWM-L-M22C-G14-F4	★ 546146
G3/8	VZWM-L-M22C-G38-F4	★ 546147
G1/2	VZWM-L-M22C-G12-F4	★ 546148
G3/4	VZWM-L-M22C-G34-F4	★ 546149
G1	VZWM-L-M22C-G1-F4	★ 546150

## Accessories

Solenoid coil MD		
Voltage	Type	Part no.
Solenoid coil for VZWM- ... -F4- ...		
24 V DC	MD-2-24VDC-PA	★ 549903

Plug socket MSSD		
Electrical connection	Type	Part no.
3-pin, square design MSF	MSSD-N	★ 550067

Pilot valves > Accessories for valves >

## Solenoid coils VACC-S13-18-K4-...-EX4ME, with explosion protection ★



- Compatible with solenoid valves VOFC, VOFD, with 13 mm armature tube
- Selected types in accordance with ATEX directive for potentially explosive atmospheres  
→ [www.festo.com/ex](http://www.festo.com/ex)

### Order code

001	002	003	004	005	006	007	008
VACC	S13	18	K4			EX4	ME

Legend:  Mandatory entry  Optional entry

001	Type
VACC	Solenoid coil, C series
002	Solenoid coil type
S13	Solenoid coil, for 13 mm armature tube
003	Power consumption
18	1.8 W
004	Electrical connection
K4	Cable connector, metric
005	Operating voltage
1U	24 V DC/AC
2U	110 V DC/AC
3U	230 V DC/AC
27U	60 V DC/AC

006	Circuitry
-	None
F	With fuse
007	ATEX certification EU
EX4	ATEX category II 2GD
008	Type of ignition protection
ME	Encapsulation, enhanced safety

### Ordering

005 Operating voltage	Type	Part no.
24 V DC/AC	VACC-S13-18-K4-1U-EX4ME	★ 8109396
	VACC-S13-18-K4-1UF-EX4ME	★ 8109399
60 V DC/AC	VACC-S13-18-K4-27U-EX4ME	★ 8109400
110 V DC/AC	VACC-S13-18-K4-2U-EX4ME	★ 8109397
230 V DC/AC	VACC-S13-18-K4-3U-EX4ME	★ 8109398





# Appendix

## Axis definition

Find your handling solution in a few steps

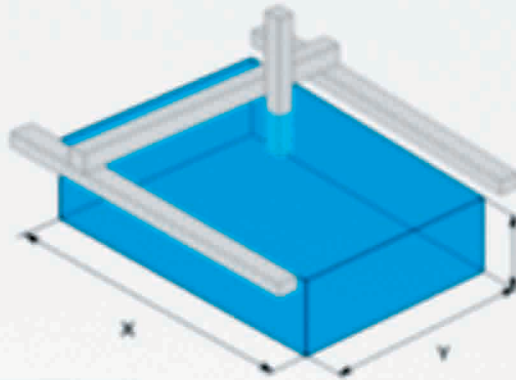

Define the drive system and working stroke

Drive system of the axis

Required working stroke

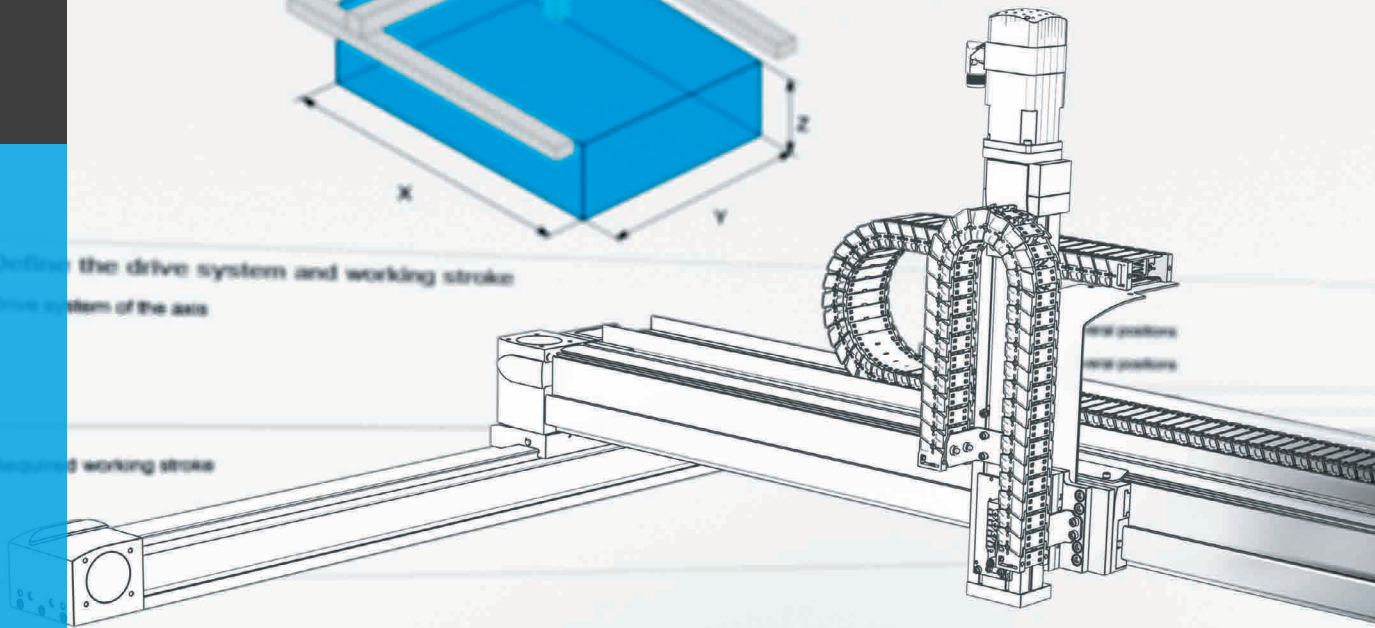



# Contents

Energy efficiency	220
Festo Services and Support	222
Food and packaging	223
Training and consulting	224
What must be taken into account when using Festo products?	225
Trademark notices	226

## Energy efficiency

### Energy efficiency in focus

We make energy efficiency happen. You can rely on our technical experts and efficient technologies that will ensure your machines and systems consume fewer resources and less energy.

This not only reduces CO<sub>2</sub> emissions, but your operating costs too. And it leads to increases too, for example in the sustainability of your production processes and your company's productivity.

#### Intelligent design

- Intelligent and innovative selection software for designing systems correctly.
- Choose smaller components, avoid the accumulation of safety factors.



#### Products and solutions

- Festo offers products and solutions that use energy more efficiently so that you can realise significant potential savings right now,
- whether with high-performance, simple pneumatic systems or precise, highly dynamic automation technology.

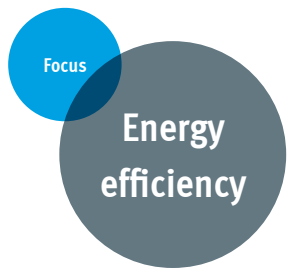

#### Industrial education

- Take advantage of the expertise of our sales engineers and energy efficiency consultants.
- Benefit from Festo Didactic's close links to industry and its training portfolio.



#### Services

- Festo Energy Saving Services: the service package for the best possible utilisation of potential savings.
- From compressed air audits to the implementation of energy-saving solutions, our specialists support you with customised services.

Just ask your local contact person or find out more at  
[→ www.festo.com/energy](http://www.festo.com/energy)

## Festo pursues a mission of sustainable management of resources and long-term value enhancement

High energy prices, rising cost pressure and a growing awareness of climate protection have turned energy efficiency into a key business task. It applies to every part of an application and therefore requires a comprehensive approach. All parameters must be correct in order for a system or machine to be energy efficient, from the planning stage through to operation.

Pneumatic systems, too, offer attractive potential savings when it comes to energy efficiency. The key to success lies in taking a thorough look at pneumatic systems.

### A sample calculation: air supply switched off during standstills

#### Energy efficiency module MSE6-E2M.

- Assembly system with 20% leakage
- Daily usage: approx. 10 hours production and 14 hours standby
- System consumption per day without MSE6-E2M: 1242 Nm<sup>3</sup>
- System consumption per day with MSE6-E2M: 970 Nm<sup>3</sup>

#### Savings: 20%

#### Three functions to save money

- Automatic shut-off of the compressed air in standby mode
- Detection and notification of leakages
- Condition monitoring for process-related data, also for Industry 4.0
- With PROFINET for the three connection variants  
M12, RJ45, SCRJ

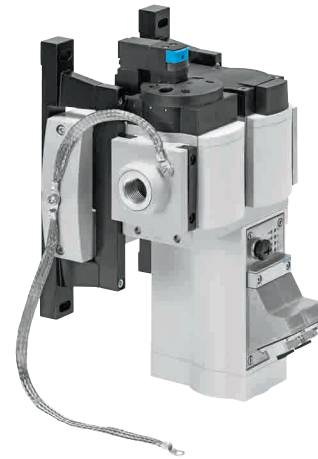

### Efficient measurement and analysis with the air-flow analyser SFGA

The proven plug & work concept from Festo has also inspired the design of the air-flow analyser. The ready-to-install analysis case can be used straightaway and includes everything you need for efficiently and flexibly measuring compressed air consumption and flow rates in your system.

#### Highlights

- Flexible flow rate and pressure measurement with a portable analysis device with integrated battery
- Extremely easy transfer of the measured values to a PC for data processing and documentation
- Including operating software
- Secure and tidy storage in the carrying case

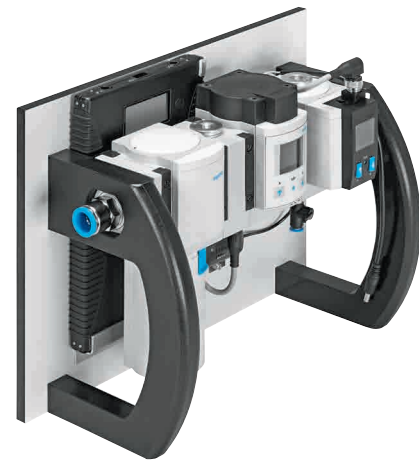

### There are opportunities – seize them!

There are lots of opportunities for increasing energy efficiency in your production processes – they only need to be exploited! Take the time to search for possible approaches – it pays off.

Our tip: Ask for advice from the experts at Festo who are extremely knowledgeable about energy efficiency and have mastered the implementation of this integrated approach.



→ [www.festo.com/energy](http://www.festo.com/energy)

## Festo Services and Support

### Consistent and comprehensive support

Festo's service and support philosophy is based on a constant analysis of the value chains of different types of customers.

Festo has built on this knowledge to develop a sophisticated portfolio that supports you along your entire value chain.

It includes numerous services such as the Energy Saving Services, customised developments of ready-to-install solutions and special designs.

Our networked digital customer information system now consists of a data-base-driven catalogue with over 30,000 products and accessories as well as tools for configuration, planning and design. Globally standardised application platforms for product lifecycle, production, logistics, sales and finance help to create integrated, global processes for your benefit.

#### Engineering



- Consulting
- Design aids
- 2D/3D CAD drawings and models
- Design and sizing tools
- Selection tools
- Engineering of ready-to-install solutions

#### Procurement/logistics



- Festo Online Shop
- 24-hour delivery service
- Logistics optimisation service
- PrePack

#### Assembly and commissioning



- Commissioning axis systems
- Compressed air consumption analysis
- Commissioning and training for servo-pneumatic welding guns

#### Operation



- Worldwide after sales service
- Energy Saving Services
- Compressed air quality analysis
- Support portal with documentation for the entire product lifecycle

Are you interested in these services?

Just ask your local contact person or find out more at → [www.festo.com/services](http://www.festo.com/services)

You will find further information about our services there.





## Food safety and efficiency ...

... are key requirements.

Our clever mix of solutions provides the perfect ingredients for production facilities that produce top-quality food economically.

→ [www.festo.com/food](http://www.festo.com/food)

→ [www.festo.com/packaging](http://www.festo.com/packaging)

## Reliable and efficient compressed air



Decide what kind of compressed air quality you need for your application. Our preconfigured service unit combinations are designed to meet your requirements and can be ordered with just a single part number. Save energy by automatically shutting off the compressed air in stand-by mode. The energy efficiency module E2M monitors and regulates the compressed air supply fully automatically.

## Certified food safe

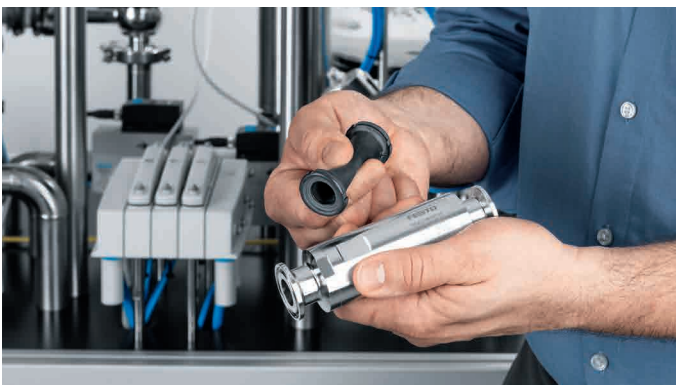

Manage demanding applications for clean and safe dispensing of food with the pneumatic pinch valve VZQA.

Its silicone diaphragm comes in an N/O variant and with a declaration of conformity in accordance with Regulation (EC) No. 1935/2004. This pinch valve variant has thus been approved for direct contact with food products.

## Maximum performance



Fast, simple and energy-efficient.

Decentralised valve terminal concepts increase the productivity of your systems. With the clean design valve terminal MPA-C there's no need for a control cabinet thanks to degree of protection IP69K.

Or you can use valve terminal VTUG in the control cabinet, with multi-pin plug, all common fieldbuses or IO-Link®.

## High operational reliability



Reliable components are essential for high machine availability.

Take the stainless-steel cylinder CRDSNU from our clean design drive portfolio, for example. It's always correctly set thanks to the self-adjusting end position cushioning system PPS – without the need for a dirt-prone adjusting screw.

## Training and consulting

Festo is a world-leading supplier of automation technology and, together with Festo Didactic, the international market leader for technical training solutions. As an integral part of the Festo Group, Festo Training and Consulting is rooted in the world of automation, and industry is just part of its DNA.

### Overview of topics



We work closely with Festo Automation and operate in the same segments as our customers. This provides us with in-depth insights into our customers' challenges and enables us to offer tailored and practical training courses for industry. Our main focus is on the core business of automation technology.

- Pneumatics
- Hydraulics
- PLCs (programmable logic controllers)
- Electrical engineering/electronics
- Process automation
- Handling systems
- Water management
- Maintenance
- Supply chain management
- Lean production
- Process optimisation
- Service and sales competence
- Industry 4.0

### Training offered



- Public courses
- Company-specific training courses
- Consulting
- Coaching
- Skills programmes
- Business games
- Learning needs analysis, certification, blended learning concepts

### Our competency – based on actual practice for real-life applications



- Industry-focused
- Global
- Customer-oriented
- Over 50 years of experience
- Certified to DIN ISO 29990:2010 as a learning service provider
- Practical learning with state-of-the-art equipment and systems
- Trainers with many years of practical experience
- In-depth knowledge of training methods and principles
- 2,900 courses annually
- 39 languages
- 42,000 participants worldwide

Do you want more details about Festo Didactic's programme or courses in your area?

Just ask your local contact person or find out more at

→ [www.festo-tac.com](http://www.festo-tac.com)

## What must be taken into account when using Festo products?

The limit values specified in the technical data and any specific safety instructions must be adhered to by the user in order to ensure correct functioning.

The pneumatic components must be supplied with correctly prepared compressed air without aggressive media.

Take the ambient conditions at the place of use into consideration. Corrosive, abrasive and dusty environments (e.g. water, ozone, grinding dust) will reduce the service life of the product.

Check the resistance of the materials of Festo products to the media used and surrounding media.

When Festo products are used in safety-oriented applications, all national and international laws and regulations, for example the EC Machinery Directive, must be observed and complied with together with the relevant references to standards, trade association rules and the applicable international regulations.

Unauthorised conversions or modifications to products and systems from Festo constitute a safety risk and are thus not permitted.

Festo does not accept any liability for any resulting damage.

You should contact Festo if one of the following applies to your application:

- The ambient conditions and conditions of use or the operating medium differ from the specified technical data.
- The product is to perform a safety function.
- A risk or safety analysis is required.
- You are unsure about the product's suitability for the planned application.
- You are unsure about the product's suitability for use in safety-oriented applications.

All technical data is correct at the time of going to print.

All content, texts, representations, illustrations and drawings included in this catalogue are the intellectual property of Festo SE & Co. KG and are protected by copyright law.

Any duplication, processing, translation, microfilming, storage, or processing in electronic systems of any kind whatsoever without the consent of Festo SE & Co. KG is prohibited.

All technical data is subject to change according to technical updates.

ABB® is a registered trademark of ABB Asea Brown Boveri Ltd. in certain countries.

Allen-Bradley® is a registered trademark of Rockwell Automation, Inc. in certain countries.

ANSI® is a registered trademark of the American National Standards Institute, Incorporated in certain countries.

AS-Interface® is a registered trademark of Verein zur Förderung busfähiger Interfaces für binäre Aktuatoren und Sensoren e. V. in certain countries.

ASME® is a registered trademark of the American Society of Mechanical Engineers in certain countries.

Beckhoff® is a registered trademark of Hans Beckhoff in certain countries.

Cage Clamp® is a registered trademark of WAGO Kontakttechnik GmbH & Co. KG in certain countries.

CANopen® is a registered trademark of CAN in AUTOMATION - International Users and Manufacturers Group e.V. in certain countries.

CC-LINK® is a registered trademark of Mitsubishi Electric Corporation in certain countries.

CIROS® is a registered trademark of Dortmunder Initiative zur rechnerintegrierten Fertigung (RIF) e.V. in certain countries.

CODESYS® is a registered trademark of 3S-Smart Software Solutions GmbH in some countries.

DeviceNet® is a registered trademark of ODVA, Inc. in certain countries.

EasyIP® is a registered trademark of Novagraaf Nederland B.V. in certain countries.

ECOLAB® is a registered trademark of Ecolab USA, Inc. in certain countries.

EHEDG European Hygienic Engineering & Design Group® is a registered trademark of Stichting Ehedg in certain countries.

EnDat® is a registered trademark of Dr. Johannes Heidenhain GmbH in certain countries.

ePLAN electric P8® and ePLAN fluid® are registered trademarks of EPLAN Software & Service GmbH & Co. KG in certain countries.

EtherCAT® is a registered trademark of Beckhoff Automation GmbH in certain countries.

Ethernet POWERLINK® is a registered trademark of ABB ASEA BROWN BOVERI LTD COMPANY in certain countries.

EtherNet/IP® is a registered trademark of ODVA, Inc. in certain countries.

Excel® is a registered trademark of Microsoft Corporation in certain countries.

Fin Ray® is a registered trademark of EvoLogics GmbH in certain countries.

HACCP - Hazard Analysis Critical Control Points® is a registered trademark of Rizzo Graziana in certain countries.

HARAX® is a registered trademark of HARTING Electric GmbH & Co. KG in certain countries.

HIPERFACE® is a registered trademark of Sick Stegmann GmbH in certain countries.

International Electrotechnical Commission® is a registered trademark of the International Electrotechnical Commission in certain countries.

INTERBUS® is a registered trademark of Phoenix Contact GmbH & Co. KG in certain countries.

IO-Link® is a registered trademark of Profibus Nutzerorganisation e.V. in certain countries.

JohnsonDiversey® is a registered trademark of S.C. Johnson & Son, Inc. in certain countries.

Loctite® is a registered trademark of Henkel IP & Holding GmbH in certain countries.

Makrolon® is a registered trademark of Covestro Deutschland AG in certain countries.

Microsoft® is a registered trademark of Microsoft Corporation in certain countries.

The above-mentioned trademarks are registered/applied-for trademarks of the respective trademark holder in certain countries. All other trademarks not listed here are the property of their respective owners in some countries.

mitsubishi® is a registered trademark of Mitsubishi Corporation in certain countries.

Modbus® is a registered trademark of Schneider Electric USA, Inc. in certain countries.

NAMUR® is a registered trademark of NAMUR - Interessengemeinschaft Automatisierungstechnik der Prozessindustrie e.V. in certain countries.

ODVA® is a registered trademark of ODVA, Inc. in certain countries.

OPC UA® is a registered trademark of the OPC Foundation in certain countries.

PROFIsafe® is a registered trademark of Siemens Aktiengesellschaft in certain countries.

Rockwell Automation® is a registered trademark of Rockwell Automation, Inc. in certain countries.

SERCOS interface® is a registered trademark of SERCOS International e.V. in certain countries.

SIMATIC® is a registered trademark of Siemens Aktiengesellschaft in certain countries.

SucoNet® is a registered trademark of Eaton Electrical IP GmbH & Co. KG in certain countries.

Systemer® is a registered trademark of TTS Tooltechnic Systems AG & Co. KG in certain countries.

Teflon® is a registered trademark of The Chemours Company FC in certain countries.

TORX® is a registered trademark of Acument Intellectual Properties, LLC in certain countries.

TwinCAT® is a registered trademark of Beckhoff Automation GmbH in certain countries.

UL® is a registered trademark of Underwriters Laboratories Inc. in certain countries.

VDMA® is a registered trademark of Verband Deutscher Maschinen- und Anlagenbau (VDMA) e.V. in certain countries.

Viton® is a registered trademark of The Chemours Company FC in certain countries.

Vulkollan® is a registered trademark of Covestro Deutschland AG in certain countries.

Windows® is a registered trademark of Microsoft Corporation in certain countries.



**Simply** part of the solution.  
The Festo core product range.

136082 (EN)  
Subject to change  
2020/02

[www.festo.com](http://www.festo.com)