



Brand of NTN Group

Technical data

UK316G2H

Insert bearings



Spherical outer diameter, fixing by adapter sleeve, seal with slinger

VISUAL (S)

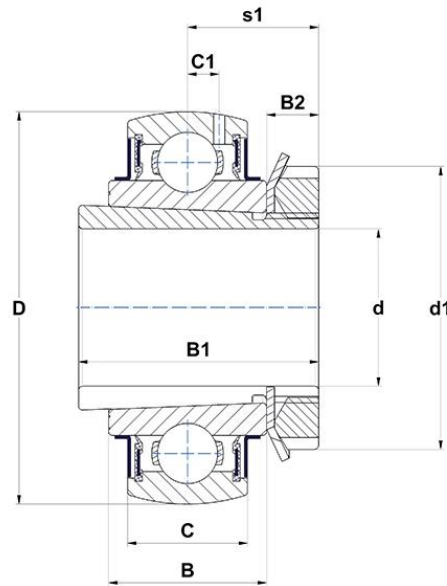

PRODUCT DEFINITION

Brand	SNR
B - Width of Inner Ring	55 mm
B1 - Overall width Inner Ring	78 mm
B2 - Width of eccentric locking collar/nut	17 mm
C - Width of Outer Ring	44 mm
C1 - Distance center of OR to center of lubrication zone	14,5 mm
d - Shaft diameter	70 mm
d1 - Outer dia of eccent. Lock. collar / nut of adapter sleeve	105 mm



NTN Europe

1 rue des Usines · BP 2017 · 74010 Annecy Cedex · France · Tel. +33 (0)4 50 65 30 00
S.A. au capital de 322 639 919 € · RCS ANNECY B 325 821 072 · Id. Fiscale : FR 48 325 821 072
SIRET 325 821 072 00015 · Code APE 2815 Z · Code NACE 28.15

PRODUCT DEFINITION

D - Outer diameter of OR	170 mm
f0 - Factor	13.2

PRODUCT PERFORMANCE

C - Dynamic load rating	122850000 mN
C0 - Static load rating	86500000 mN
Operating temperature min.	253,15 °K
Operating temperature max.	373,15 °K

OTHER FEATURES

Mass	5,59 kg
Adapter sleeve designation	H2316

BEARING FREQUENCIES

BPFO - Over rolling frequency on outer ring (60 rpm)	3.086 Hz
BPFI - Over rolling frequency on inner (60 rpm)	4.914 Hz
BSF - Over rolling frequency on rolling element (60 rpm)	4.146 Hz
BRF - Rotational frequency - rolling element (60 rpm)	2.073 Hz
FTF - Rotational frequency - cage (60 rpm)	0.386 Hz

