

## FEATURES

- **16-Bit 150ksps ADCs in MSOP Package**
- Single 3V Supply
- Low Supply Current: 450μA (Typ)
- Auto Shutdown Reduces Supply Current to 10μA at 1ksps
- True Differential Inputs
- 1-Channel (LTC1864L) or 2-Channel (LTC1865L) Versions
- SPI/MICROWIRE™ Compatible Serial I/O
- 16-Bit Upgrade to 12-Bit LTC1285/LTC1288
- Pin Compatible with 12-Bit LTC1860L/LTC1861L
- No Minimum Data Transfer Rate

## APPLICATIONS

- High Speed Data Acquisition
- Portable or Compact Instrumentation
- Low Power Battery-Operated Instrumentation
- Isolated and/or Remote Data Acquisition

## DESCRIPTION

The LTC®1864L/LTC1865L are 16-bit A/D converters that are offered in MSOP and SO-8 packages and operate on a single 3V supply. At 150ksps, the supply current is only 450μA. The supply current drops at lower speeds because the LTC1864L/LTC1865L automatically power down between conversions. These 16-bit switched capacitor successive approximation ADCs include sample-and-holds. The LTC1864L has a differential analog input with an external reference pin. The LTC1865L offers a software-selectable 2-channel MUX and an external reference pin on the MSOP version.

The 3-wire, serial I/O, small MSOP or SO-8 package and extremely high sample rate-to-power ratio make these ADCs ideal choices for compact, low power, high speed systems.

These ADCs can be used in ratiometric applications or with external references. The high impedance analog inputs and the ability to operate with reduced spans down to 1V full scale allow direct connection to signal sources in many applications, eliminating the need for external gain stages.

LT, LTC and LT are registered trademarks of Linear Technology Corporation. MICROWIRE is a trademark of National Semiconductor Corporation.

## TYPICAL APPLICATION

Single 3V Supply, 150ksps, 16-Bit Sampling ADC

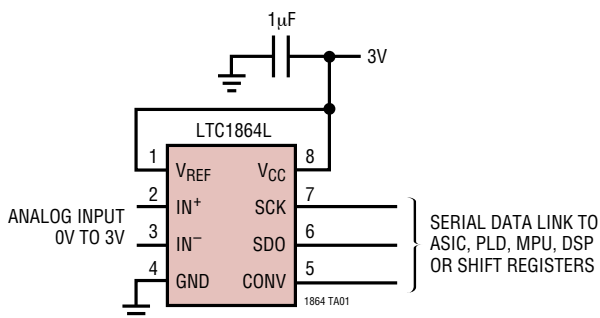

Supply Current vs Sampling Frequency

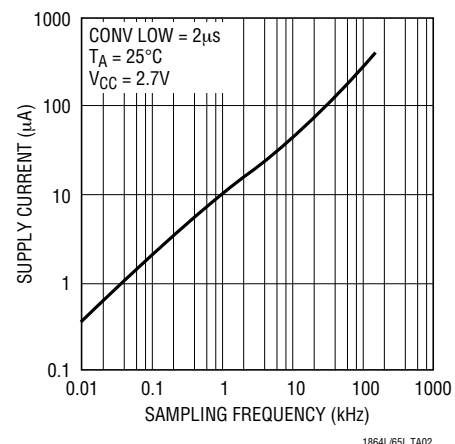

# LTC1864L/LTC1865L

## ABSOLUTE MAXIMUM RATINGS (Notes 1, 2)

Supply Voltage ( $V_{CC}$ ) .....	7V	Operating Temperature Range	
Ground Voltage Difference		LTC1864LC/LTC1865LC/	
AGND, DGND LTC1865L MSOP Package .....	$\pm 0.3V$	LTC1864LAC/LTC1865LAC .....	$0^{\circ}C$ to $70^{\circ}C$
Analog Input .....	(GND – 0.3V) to ( $V_{CC}$ + 0.3V)	LTC1864LI/LTC1865LI/	
Digital Input .....	(GND – 0.3V) to 7V	LTC1864LAI/LTC1865LAI .....	$-40^{\circ}C$ to $85^{\circ}C$
Digital Output .....	(GND – 0.3V) to ( $V_{CC}$ + 0.3V)	Storage Temperature Range .....	$-65^{\circ}C$ to $150^{\circ}C$
Power Dissipation .....	400mW	Lead Temperature (Soldering, 10 sec) .....	$300^{\circ}C$

## PACKAGE/ORDER INFORMATION

<p>MS8 PACKAGE 8-LEAD PLASTIC MSOP <math>T_{JMAX} = 150^{\circ}C, \theta_{JA} = 210^{\circ}C/W</math></p>	ORDER PART NUMBER	<p>MS PACKAGE 10-LEAD PLASTIC MSOP <math>T_{JMAX} = 150^{\circ}C, \theta_{JA} = 210^{\circ}C/W</math></p>	ORDER PART NUMBER
	LTC1864LCMS8 LTC1864LIMS8 LTC1864LACMS8 LTC1864LAIMS8		LTC1865LCMS8 LTC1865LIMS8 LTC1865LACMS8 LTC1865LAIMS8
	MS8 PART MARKING		MS PART MARKING
	LTC7		LTJ4
<p>S8 PACKAGE 8-LEAD PLASTIC SO <math>T_{JMAX} = 150^{\circ}C, \theta_{JA} = 175^{\circ}C/W</math></p>	ORDER PART NUMBER	<p>S8 PACKAGE 8-LEAD PLASTIC SO <math>T_{JMAX} = 150^{\circ}C, \theta_{JA} = 175^{\circ}C/W</math></p>	ORDER PART NUMBER
	LTC1864LCS8 LTC1864LIS8 LTC1864LACS8 LTC1864LAIS8		LTC1865LCS8 LTC1865LIS8 LTC1865LACS8 LTC1865LAIS8
	S8 PART MARKING		S8 PART MARKING
	1864L 1864LA 1864LI 864LAI		1865L 1865LA 1865LI 865LAI

Consult LTC Marketing for parts specified with wider operating temperature ranges.

## CONVERTER AND MULTIPLEXER CHARACTERISTICS

The ● denotes specifications which apply over the full operating temperature range, otherwise specifications are  $T_A = 25^{\circ}C$ .  $V_{CC} = 2.7V$ ,  $V_{REF} = 2.5V$ ,  $f_{SCK} = f_{SCK(MAX)}$  as defined in Recommended Operating Conditions, unless otherwise noted.

PARAMETER	CONDITIONS	LTC1864L/LTC1865L			LTC1864LA/LTC1865LA			UNITS
		MIN	TYP	MAX	MIN	TYP	MAX	
Resolution		●	16		16			Bits
No Missing Codes Resolution		●	14		15			Bits
INL	(Note 3)	●		$\pm 8$		$\pm 6$		LSB
Transition Noise			2		2			LSB <sub>RMS</sub>
Gain Error		●		$\pm 20$		$\pm 20$		mV

sn18645L 18645Lfs

## CONVERTER AND MULTIPLEXER CHARACTERISTICS

The ● denotes specifications which apply over the full operating temperature range, otherwise specifications are  $T_A = 25^\circ\text{C}$ .  $V_{CC} = 2.7\text{V}$ ,  $V_{REF} = 2.5\text{V}$ ,  $f_{SCK} = f_{SCK(\text{MAX})}$  as defined in Recommended Operating Conditions, unless otherwise noted.

PARAMETER	CONDITIONS	LTC1864L/LTC1865L			LTC1864LA/LTC1865LA			UNITS
		MIN	TYP	MAX	MIN	TYP	MAX	
Offset Error		●	±2	±5		±2	±5	mV
Input Differential Voltage Range	$V_{IN} = IN^+ - IN^-$	●	0	$V_{REF}$	0	$V_{REF}$		V
Absolute Input Range	$IN^+$ Input		-0.05	$V_{CC} + 0.05$	-0.05	$V_{CC} + 0.05$		V
	$IN^-$ Input		-0.05	$V_{CC}/2$	-0.05	$V_{CC}/2$		V
$V_{REF}$ Input Range	LTC1864L SO-8 and MSOP, LTC1865L MSOP		1	$V_{CC}$	1	$V_{CC}$		V
Analog Input Leakage Current	(Note 4)	●		±1		±1		μA
$C_{IN}$ Input Capacitance	In Sample Mode		12		12			pF
	During Conversion		5		5			pF

## DYNAMIC ACCURACY

$T_A = 25^\circ\text{C}$ .  $V_{CC} = 3\text{V}$ ,  $V_{REF} = 3\text{V}$ ,  $f_{\text{SAMPLE}} = 150\text{kHz}$ , unless otherwise noted.

SYMBOL	PARAMETER	CONDITIONS	LTC1864L/LTC1865L			UNITS
			MIN	TYP	MAX	
SNR	Signal-to-Noise Ratio			82		dB
S/(N + D)	Signal-to-Noise Plus Distortion Ratio	1kHz Input Signal		82		dB
THD	Total Harmonic Distortion Up to 5th Harmonic	1kHz Input Signal		92		dB
	Full Power Bandwidth			10		MHz
	Full Linear Bandwidth	$S/(N + D) \geq 75\text{dB}$		20		kHz

## DIGITAL AND DC ELECTRICAL CHARACTERISTICS

The ● denotes specifications which apply over the full operating temperature range, otherwise specifications are  $T_A = 25^\circ\text{C}$ .  $V_{CC} = 2.7\text{V}$ ,  $V_{REF} = 2.5\text{V}$ , unless otherwise noted.

SYMBOL	PARAMETER	CONDITION	LTC1864L/LTC1865L			UNITS
			MIN	TYP	MAX	
$V_{IH}$	High Level Input Voltage	$V_{CC} = 3.3\text{V}$	●	1.9		V
$V_{IL}$	Low Level Input Voltage	$V_{CC} = 2.7\text{V}$	●		0.45	V
$I_{IH}$	High Level Input Current	$V_{IN} = V_{CC}$	●		2.5	μA
$I_{IL}$	Low Level Input Current	$V_{IN} = 0\text{V}$	●		-2.5	μA
$V_{OH}$	High Level Output Voltage	$V_{CC} = 2.7\text{V}$ , $I_O = 10\mu\text{A}$	●	2.3	2.6	V
		$V_{CC} = 2.7\text{V}$ , $I_O = 360\mu\text{A}$	●	2.1	2.45	V
$V_{OL}$	Low Level Output Voltage	$V_{CC} = 2.7\text{V}$ , $I_O = 400\mu\text{A}$	●		0.3	V
$I_{OZ}$	Hi-Z Output Leakage	$CONV = V_{CC}$	●		±3	μA
$I_{SOURCE}$	Output Source Current	$V_{OUT} = 0\text{V}$		-6.5		mA
$I_{SINK}$	Output Sink Current	$V_{OUT} = V_{CC}$		6.5		mA
$I_{REF}$	Reference Current (LTC1864L SO-8 and MSOP, LTC1865L MSOP)	$CONV = V_{CC}$	●	0.001	3	μA
		$f_{SMPL} = f_{SMPL(\text{MAX})}$	●	0.01	0.1	mA
$I_{CC}$	Supply Current	$CONV = V_{CC}$ After Conversion	●	0.5	10	μA
		$f_{SMPL} = f_{SMPL(\text{MAX})}$	●	0.45	1.0	mA
$P_D$	Power Dissipation	$f_{SMPL} = f_{SMPL(\text{MAX})}$		1.22		mW

## RECOMMENDED OPERATING CONDITIONS

The ● denotes specifications which apply over the full operating temperature range, otherwise specifications are  $T_A = 25^\circ\text{C}$ .

SYMBOL	PARAMETER	CONDITIONS	LTC1864L/LTC1865L			UNITS
			MIN	TYP	MAX	
$V_{CC}$	Supply Voltage		2.7		3.6	V
$f_{SCK}$	Clock Frequency		● DC		8	MHz
$t_{CYC}$	Total Cycle Time		$16 \cdot SCK + t_{CONV}$			$\mu\text{s}$
$t_{SMPL}$	Analog Input Sampling Time (Note 5)	LTC1864L LTC1865L	16 14			SCK SCK
$t_{suCONV}$	Setup Time CONV↓ Before First SCK↑ (See Figure 1)		60			ns
$t_{hDI}$	Hold Time SDI After SCK↑	LTC1865L	30			ns
$t_{suDI}$	Setup Time SDI Stable Before SCK↑	LTC1865L	30			ns
$t_{WHCLK}$	SCK High Time	$f_{SCK} = f_{SCK(MAX)}$	45%			$1/f_{SCK}$
$t_{WLCLK}$	SCK Low Time	$f_{SCK} = f_{SCK(MAX)}$	45%			$1/f_{SCK}$
$t_{WHCONV}$	CONV High Time Between Data Transfer Cycles		$t_{CONV}$			$\mu\text{s}$
$t_{WLCONV}$	CONV Low Time During Data Transfer		16			SCK
$t_{hCONV}$	Hold Time CONV Low After Last SCK↑		26			ns

## TIMING CHARACTERISTICS

The ● denotes specifications which apply over the full operating temperature range, otherwise specifications are  $T_A = 25^\circ\text{C}$ .  $V_{CC} = 2.7\text{V}$ ,  $V_{REF} = 2.5\text{V}$ ,  $f_{SCK} = f_{SCK(MAX)}$  as defined in Recommended Operating Conditions, unless otherwise noted.

SYMBOL	PARAMETER	CONDITIONS	LTC1864L/LTC1865L			UNITS
			MIN	TYP	MAX	
$t_{CONV}$	Conversion Time (See Figure 1)			● 3.7	4.66	$\mu\text{s}$
$f_{SMPL(MAX)}$	Maximum Sampling Frequency		● 150			kHz
$t_{dDO}$	Delay Time, SCK↓ to SDO Data Valid	$C_{LOAD} = 20\text{pF}$		● 45	55 60	ns ns
$t_{dis}$	Delay Time, CONV↑ to SDO Hi-Z			● 55	120	ns
$t_{en}$	Delay Time, CONV↓ to SDO Enabled	$C_{LOAD} = 20\text{pF}$		● 35	120	ns
$t_{hDO}$	Time Output Data Remains Valid After SCK↓	$C_{LOAD} = 20\text{pF}$		● 5	15	ns
$t_r$	SDO Rise Time	$C_{LOAD} = 20\text{pF}$			25	ns
$t_f$	SDO Fall Time	$C_{LOAD} = 20\text{pF}$			12	ns

**Note 1:** Absolute Maximum Ratings are those values beyond which the life of a device may be impaired.

**Note 2:** All voltage values are with respect to GND.

**Note 3:** Integral nonlinearity is defined as deviation of a code from a straight line passing through the actual endpoints of the transfer curve. The deviation is measured from the center of the quantization band.

**Note 4:** Channel leakage current is measured while the part is in sample mode.

**Note 5:** Assumes  $f_{SCK} = f_{SCK(MAX)}$ . In the case of the LTC1864L SCK does not have to be clocked during this time if the SDO data word is not desired. In the case of the LTC1865L a minimum of 2 clocks are required on the SCK input after CONV falls to configure the MUX during this time.

# TYPICAL PERFORMANCE CHARACTERISTICS

**Supply Current vs Sampling Frequency**

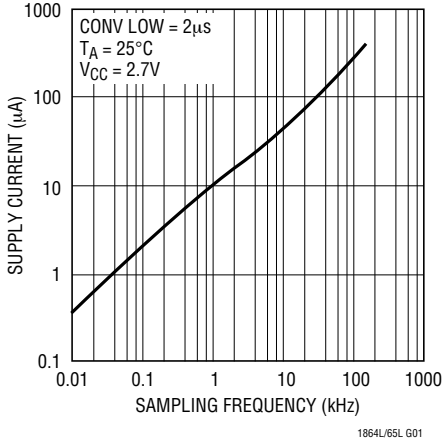

**Supply Current vs Temperature**

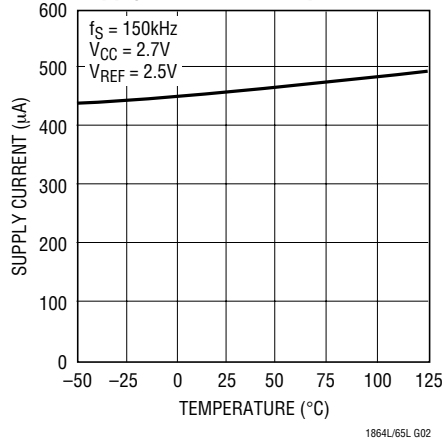

**Sleep Current vs Temperature**

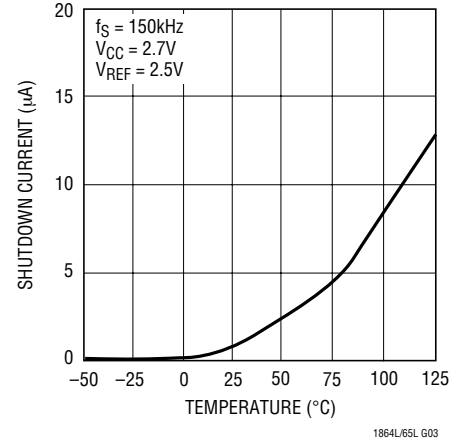

**Reference Current vs Sampling Rate**

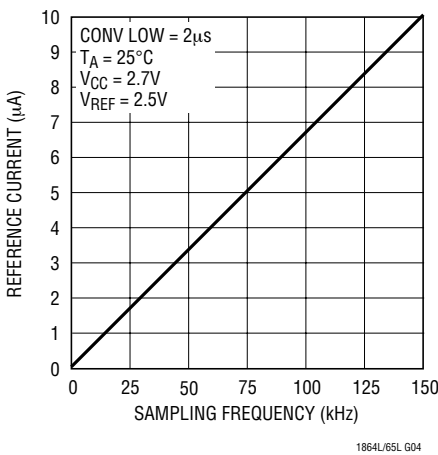

**Reference Current vs Temperature**

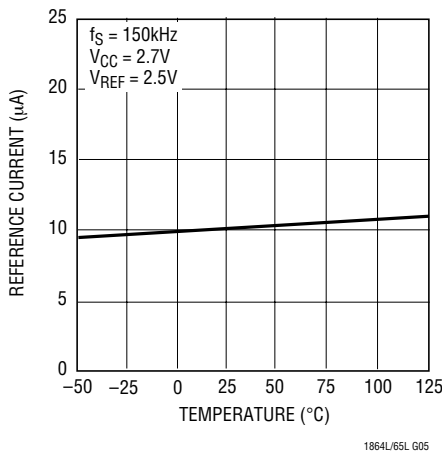

**Reference Current vs Reference Voltage**

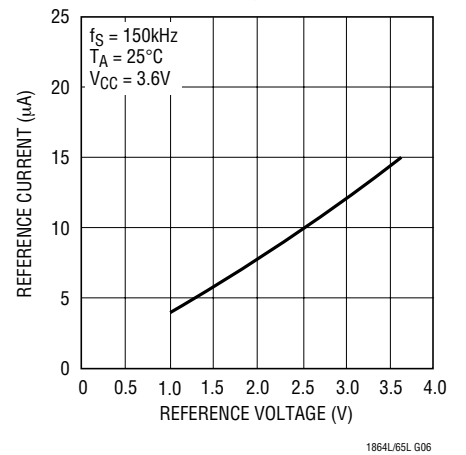

**Typical INL Curve**

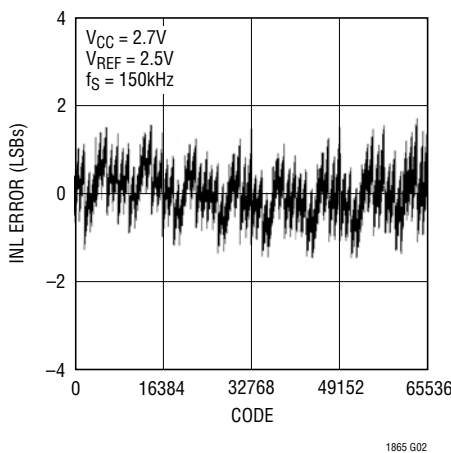

**Typical DNL Curve**

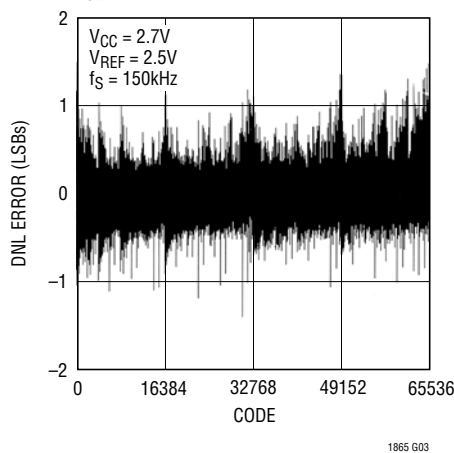

**Analog Input Leakage Current vs Temperature**

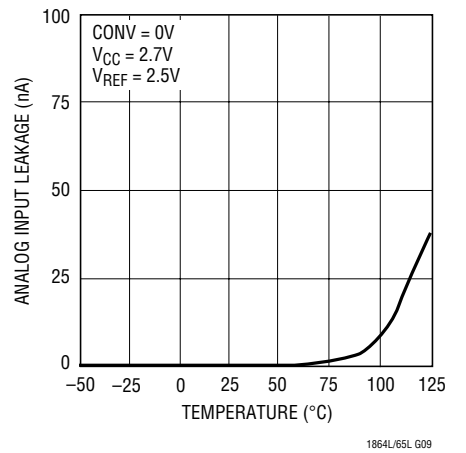

# TYPICAL PERFORMANCE CHARACTERISTICS

**Change in Offset vs Reference Voltage**

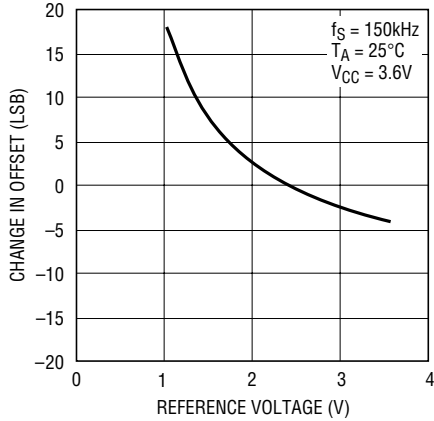

1864L/65L G10

**Change in Offset vs Temperature**

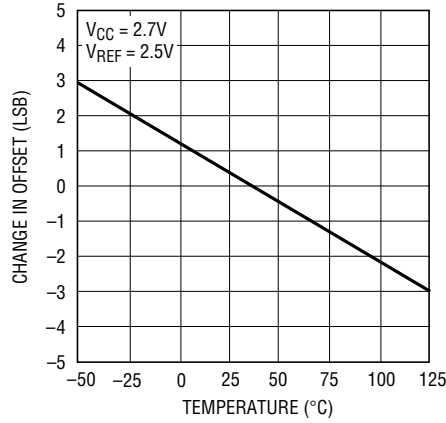

1864L/65L G11

**Change in Gain Error vs Reference Voltage**

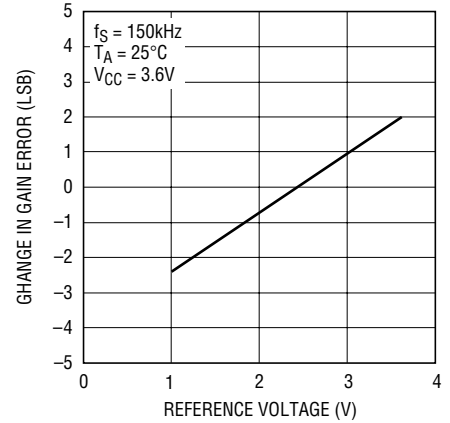

1864L/65L G12

**Change in Gain Error vs Temperature**

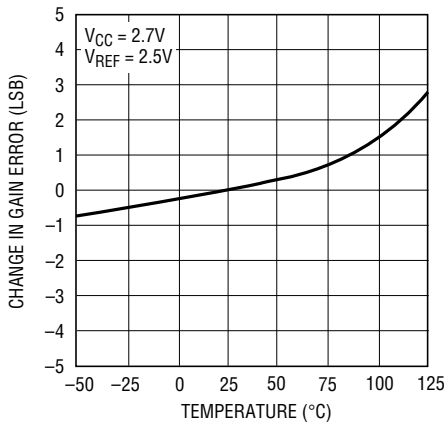

1864L/65L G13

**Histogram of 4096 Conversions of a DC Input Voltage**

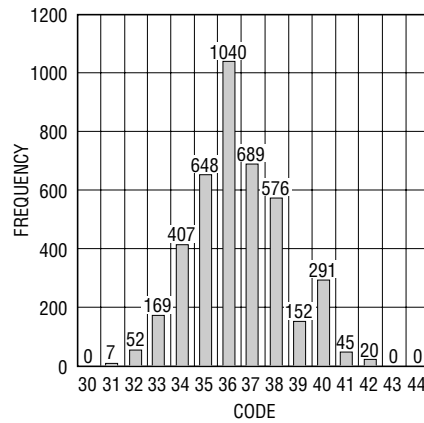

1864L/65L G14

**4096 Point FFT Nonaveraged**

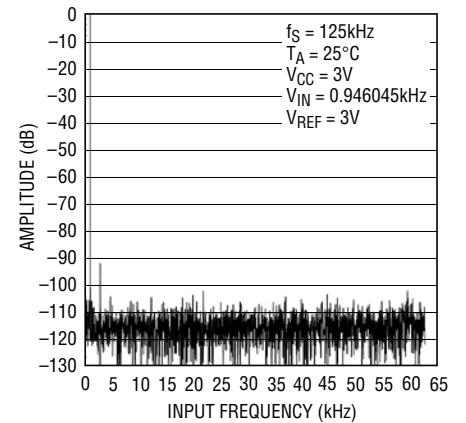

1864L/65L G15

**SINAD vs Input Frequency**

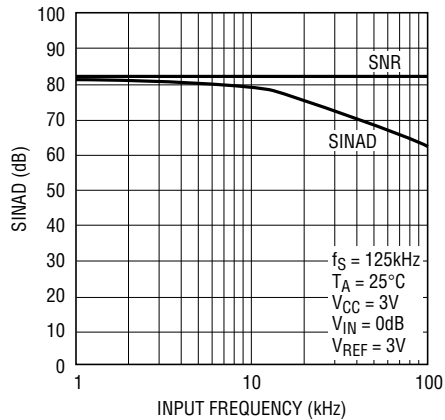

1864L/65L G16

**THD vs Input Frequency**

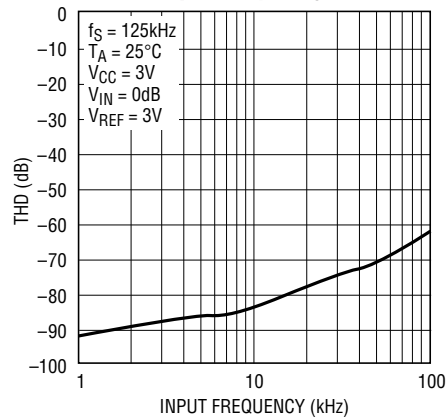

1864L/65L G17

**SFDR vs Input Frequency**

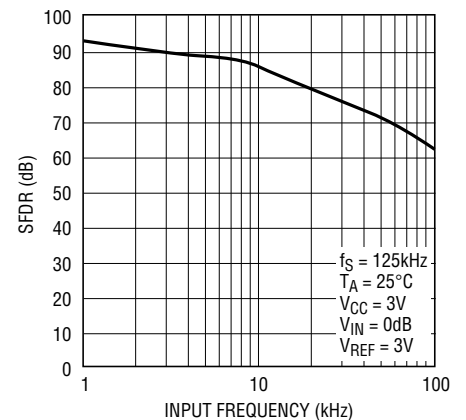

1864L/65L G18

## PIN FUNCTIONS

### LTC1864L

**V<sub>REF</sub> (Pin 1):** Reference Input. The reference input defines the span of the A/D converter and must be kept free of noise with respect to GND.

**IN<sup>+</sup>, IN<sup>-</sup> (Pins 2, 3):** Analog Inputs. These inputs must be free of noise with respect to GND.

**GND (Pin 4):** Analog Ground. GND should be tied directly to an analog ground plane.

**CONV (Pin 5):** Convert Input. A logic high on this input starts the A/D conversion process. If the CONV input is left high after the A/D conversion is finished, the part powers

down. A logic low on this input enables the SDO pin, allowing the data to be shifted out.

**SDO (Pin 6):** Digital Data Output. The A/D conversion result is shifted out of this pin.

**SCK (Pin 7):** Shift Clock Input. This clock synchronizes the serial data transfer.

**V<sub>CC</sub> (Pin 8):** Positive Supply. This supply must be kept free of noise and ripple by bypassing directly to the analog ground plane.

### LTC1865L (MSOP Package)

**CONV (Pin 1):** Convert Input. A logic high on this input starts the A/D conversion process. If the CONV input is left high after the A/D conversion is finished, the part powers down. A logic low on this input enables the SDO pin, allowing the data to be shifted out.

**CH0, CH1 (Pins 2, 3):** Analog Inputs. These inputs must be free of noise with respect to AGND.

**AGND (Pin 4):** Analog Ground. AGND should be tied directly to an analog ground plane.

**DGND (Pin 5):** Digital Ground. DGND should be tied directly to an analog ground plane.

**SDI (Pin 6):** Digital Data Input. The A/D configuration word is shifted into this input.

**SDO (Pin 7):** Digital Data Output. The A/D conversion result is shifted out of this output.

**SCK (Pin 8):** Shift Clock Input. This clock synchronizes the serial data transfer.

**V<sub>CC</sub> (Pin 9):** Positive Supply. This supply must be kept free of noise and ripple by bypassing directly to the analog ground plane.

**V<sub>REF</sub> (Pin 10):** Reference Input. The reference input defines the span of the A/D converter and must be kept free of noise with respect to AGND.

### LTC1865L (SO-8 Package)

**CONV (Pin 1):** Convert Input. A logic high on this input starts the A/D conversion process. If the CONV input is left high after the A/D conversion is finished, the part powers down. A logic low on this input enables the SDO pin, allowing the data to be shifted out.

**CH0, CH1 (Pins 2, 3):** Analog Inputs. These inputs must be free of noise with respect to GND.

**GND (Pin 4):** Analog Ground. GND should be tied directly to an analog ground plane.

**SDI (Pin 5):** Digital Data Input. The A/D configuration word is shifted into this input.

**SDO (Pin 6):** Digital Data Output. The A/D conversion result is shifted out of this output.

**SCK (Pin 7):** Shift Clock Input. This clock synchronizes the serial data transfer.

**V<sub>CC</sub> (Pin 8):** Positive Supply. This supply must be kept free of noise and ripple by bypassing directly to the analog ground plane. V<sub>REF</sub> is tied internally to this pin.

# FUNCTIONAL BLOCK DIAGRAM

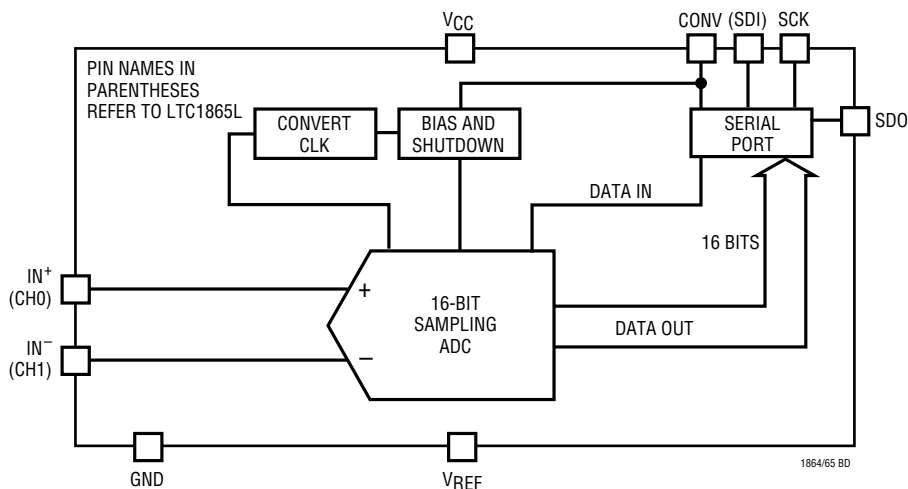

## TEST CIRCUITS

Load Circuit for  $t_{dDO}$ ,  $t_r$ ,  $t_f$ ,  $t_{dis}$  and  $t_{en}$

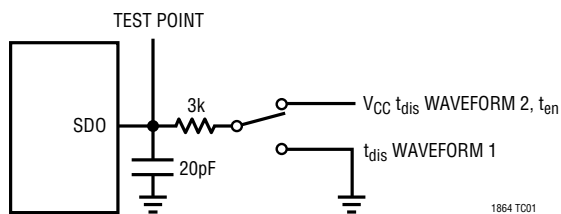

Voltage Waveforms for SDO Rise and Fall Times,  $t_r$ ,  $t_f$

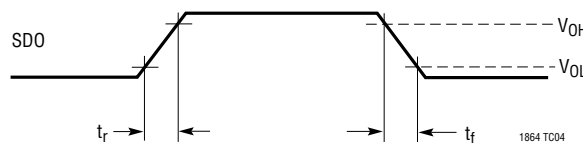

Voltage Waveforms for  $t_{en}$

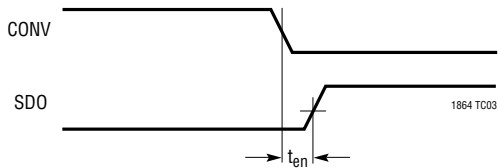

Voltage Waveforms for  $t_{dis}$

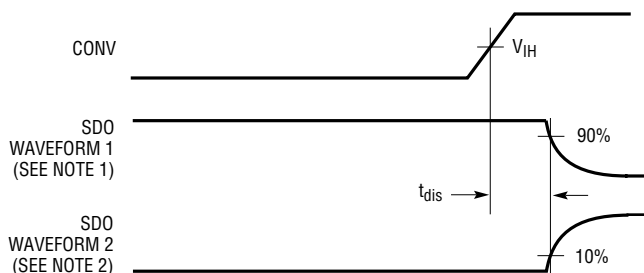

Voltage Waveforms for SDO Delay Times,  $t_{dDO}$  and  $t_{hDO}$

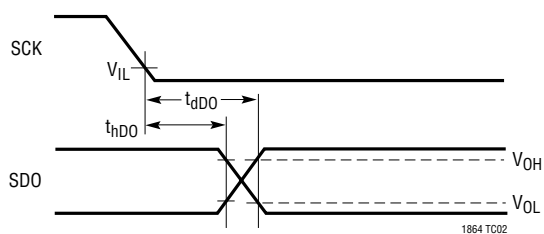

NOTE 1: WAVEFORM 1 IS FOR AN OUTPUT WITH INTERNAL CONDITIONS SUCH THAT THE OUTPUT IS HIGH UNLESS DISABLED BY THE OUTPUT CONTROL  
 NOTE 2: WAVEFORM 2 IS FOR AN OUTPUT WITH INTERNAL CONDITIONS SUCH THAT THE OUTPUT IS LOW UNLESS DISABLED BY THE OUTPUT CONTROL

1864 TC05



# APPLICATIONS INFORMATION

## LTC1864L OPERATION

### Operating Sequence

The LTC1864L conversion cycle begins with the rising edge of CONV. After a period equal to  $t_{CONV}$ , the conversion is finished. If CONV is left high after this time, the LTC1864L goes into sleep mode drawing only leakage current. On the falling edge of CONV, the LTC1864L goes into sample mode and SDO is enabled. SCK synchronizes the data transfer with each bit being transmitted from SDO on the falling SCK edge. The receiving system should capture the data from SDO on the rising edge of SCK. After completing the data transfer, if further SCK clocks are applied with CONV low, SDO will output zeros indefinitely. See Figure 1.

### Analog Inputs

The LTC1864L has a unipolar differential analog input. The converter will measure the voltage between the “IN+” and “IN-” inputs. A zero code will occur when  $IN^+$  minus  $IN^-$  equals zero. Full scale occurs when  $IN^+$  minus  $IN^-$  equals  $V_{REF}$  minus 1LSB. See Figure 2. Both the “IN+” and “IN-” inputs are sampled at the same time, so common mode noise on the inputs is rejected by the ADC. If “IN-” is grounded and  $V_{REF}$  is tied to  $V_{CC}$ , a rail-to-rail input span will result on “IN+” as shown in Figure 3.

### Reference Input

The voltage on the reference input of the LTC1864L defines the full-scale range of the A/D converter. The LTC1864L can operate with reference voltages from  $V_{CC}$  to 1V.

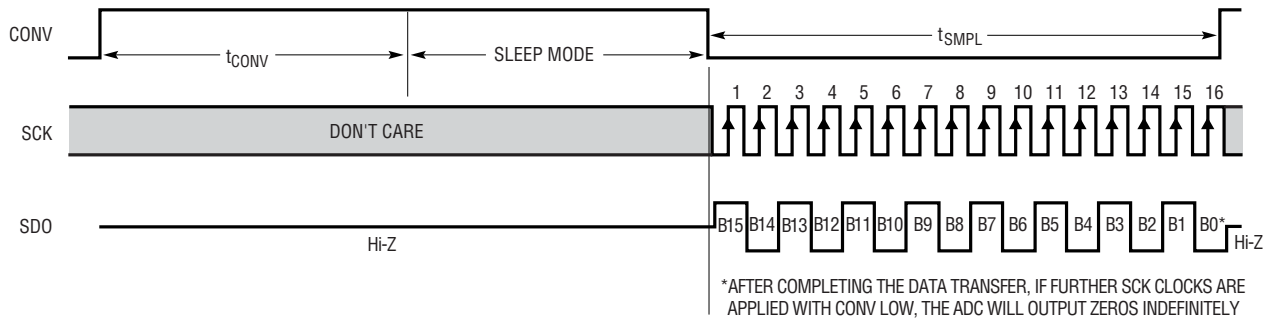

Figure 1. LTC1864L Operating Sequence

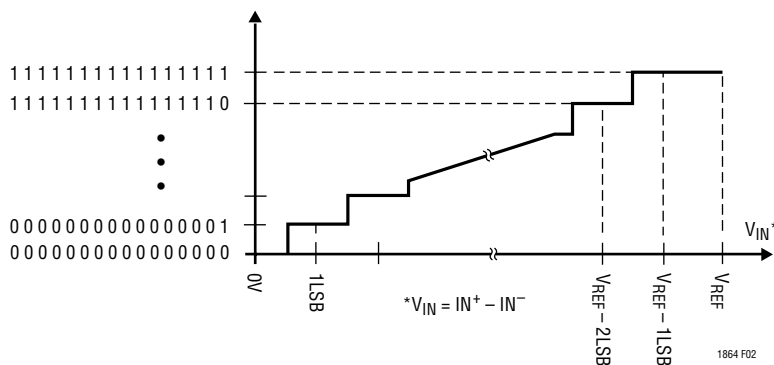

Figure 2. LTC1864L Transfer Curve

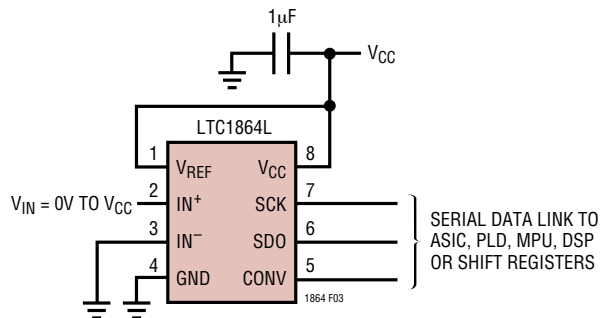

Figure 3. LTC1864L with Rail-to-Rail Input Span

## APPLICATIONS INFORMATION

### LTC1865L OPERATION

#### Operating Sequence

The LTC1865L conversion cycle begins with the rising edge of CONV. After a period equal to  $t_{CONV}$ , the conversion is finished. If CONV is left high after this time, the LTC1865L goes into sleep mode drawing only leakage current. The LTC1865L's 2-bit data word is clocked into the SDI input on the rising edge of SCK after CONV goes low. Additional inputs on the SDI pin are then ignored until the next CONV cycle. The shift clock (SCK) synchronizes the data transfer with each bit being transmitted on the falling SCK edge and captured on the rising SCK edge in both transmitting and receiving systems. The data is transmitted and received simultaneously (full duplex). After completing the data transfer, if further SCK clocks are applied with CONV low, SDO will output zeros indefinitely. See Figure 4.

#### Analog Inputs

The two bits of the input word (SDI) assign the MUX configuration for the next requested conversion. For a given channel selection, the converter will measure the voltage between the two channels indicated by the “+” and “-” signs in the selected row of Table 1. In

single-ended mode, all input channels are measured with respect to GND. A zero code will occur when the “+” input minus the “-” input equals zero. Full scale occurs when the “+” input minus the “-” input equals  $V_{REF}$  minus 1LSB. See Figure 5. Both the “+” and “-” inputs are sampled at the same time so common mode noise is rejected. The input span in the SO-8 package is fixed at  $V_{REF} = V_{CC}$ . If the “-” input in differential mode is grounded, a rail-to-rail input span will result on the “+” input.

#### Reference Input

The reference input of the LTC1865L SO-8 package is internally tied to  $V_{CC}$ . The span of the A/D converter is therefore equal to  $V_{CC}$ . The voltage on the reference input of the LTC1865L MSOP package defines the span of the A/D converter. The LTC1865L MSOP package can operate with reference voltages from 1V to  $V_{CC}$ .

**Table 1. Multiplexer Channel Selection**

	MUX ADDRESS		CHANNEL #		
	SGL/DIFF	ODD/SIGN	0	1	GND
SINGLE-ENDED MUX MODE	1	0	+	-	-
	1	1		+	-
DIFFERENTIAL MUX MODE	0	0	+	-	-
	0	1	-	+	-

1864 TBL1

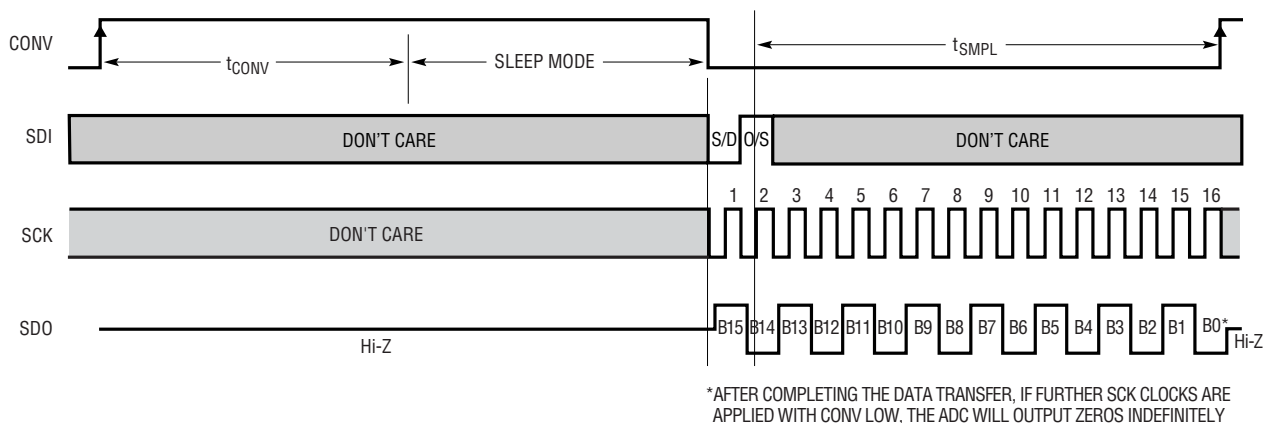

1864 F04

**Figure 4. LTC1865L Operating Sequence**

## APPLICATIONS INFORMATION

### GENERAL ANALOG CONSIDERATIONS

#### Grounding

The LTC1864L/LTC1865L should be used with an analog ground plane and single point grounding techniques. Do not use wire wrapping techniques to breadboard and evaluate the device. To achieve the optimum performance, use a printed circuit board. The ground pins (AGND and DGND for the LTC1865L MSOP package and GND for the LTC1864L and LTC1865L SO-8 package) should be tied directly to the analog ground plane with minimum lead length.

#### Bypassing

For good performance, the  $V_{CC}$  and  $V_{REF}$  pins must be free of noise and ripple. Any changes in the  $V_{CC}/V_{REF}$  voltage with respect to ground during the conversion cycle can

induce errors or noise in the output code. Bypass the  $V_{CC}$  and  $V_{REF}$  pins directly to the analog ground plane with a minimum of  $1\mu\text{F}$  tantalum. Keep the bypass capacitor leads as short as possible.

#### Analog Inputs

Because of the capacitive redistribution A/D conversion techniques used, the analog inputs of the LTC1864L/LTC1865L have capacitive switching input current spikes. These current spikes settle quickly and do not cause a problem if source resistances are less than  $200\Omega$  or high speed op amps are used (e.g., the LT<sup>®</sup>1211, LT1469, LT1807, LT1810, LT1630, LT1226 or LT1215). But if large source resistances are used, or if slow settling op amps drive the inputs, take care to ensure the transients caused by the current spikes settle completely before the conversion begins.

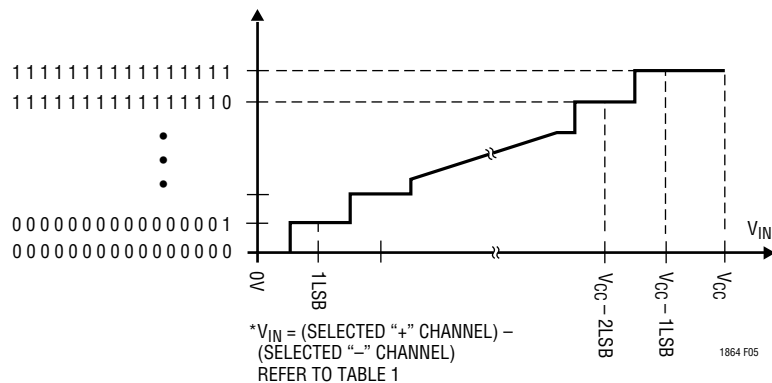
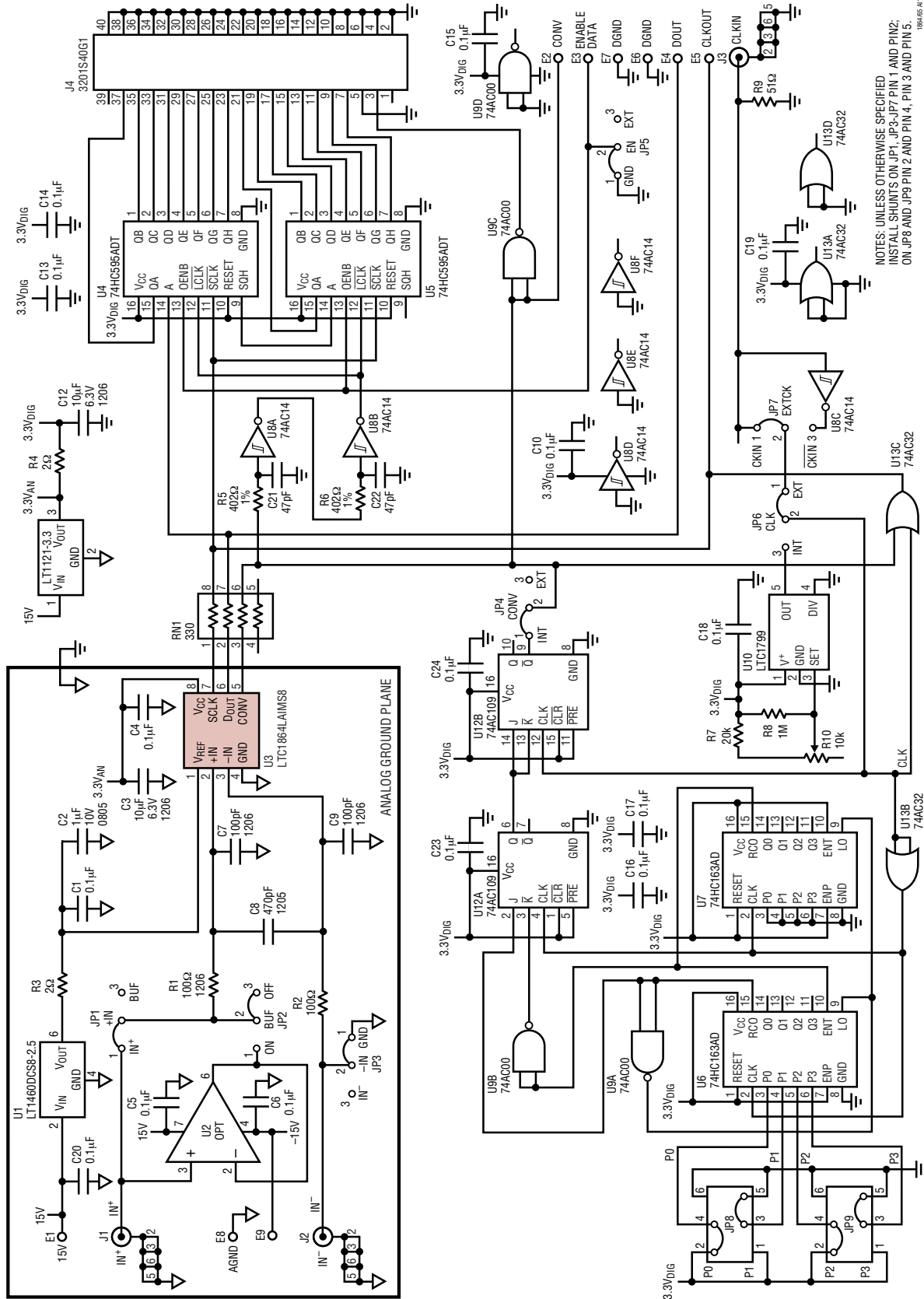

Figure 5. LTC1865L Transfer Curve

APPLICATIONS INFORMATION

LTC1864L Evaluation Circuit Schematic



NOTES: UNLESS OTHERWISE SPECIFIED  
 INSTALL SHUNTS ON JP1, JP3-JP7 PIN 1 AND PIN2;  
 ON JP8 AND JP9 PIN 2 AND PIN 4, PIN 3 AND PIN 5.

APPLICATIONS INFORMATION

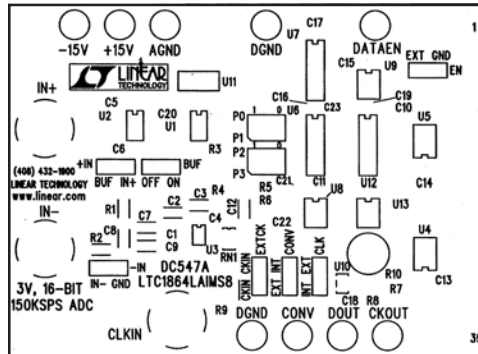

Component Side Silk Screen for LTC1864L Evaluation Circuit

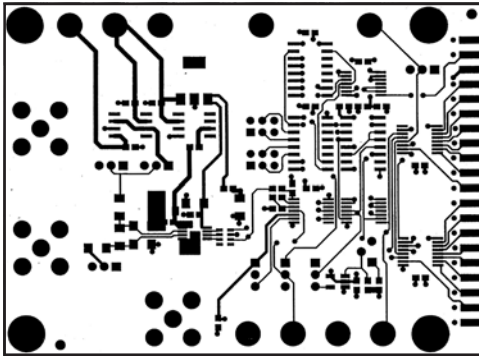

Component Side Showing Traces  
(Note Wider Traces on Analog Side)

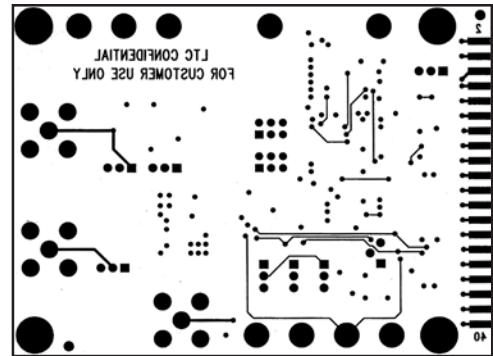

Bottom Side Showing Traces  
(Note Almost No Analog Traces on Board Bottom)

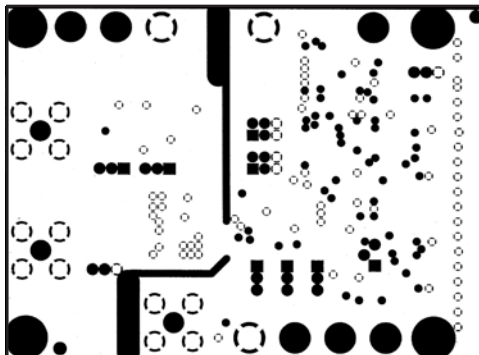

Ground Layer with Separate Analog and Digital Grounds

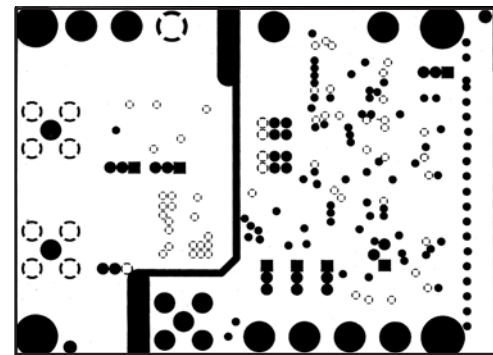

Supply Layer with 5V Digital Supply and Analog Ground Repeated

# PACKAGE DESCRIPTION

**MS8 Package**  
**8-Lead Plastic MSOP**  
 (Reference LTC DWG # 05-08-1660)

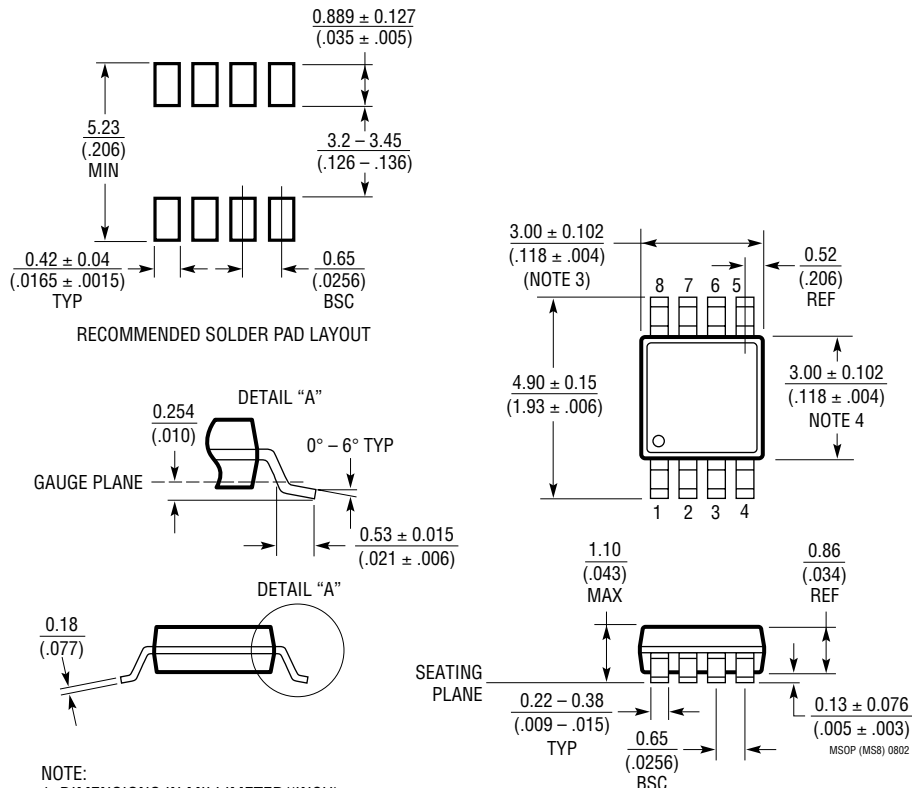

- NOTE:
1. DIMENSIONS IN MILLIMETER/(INCH)
  2. DRAWING NOT TO SCALE
  3. DIMENSION DOES NOT INCLUDE MOLD FLASH, PROTRUSIONS OR GATE BURRS.  
MOLD FLASH, PROTRUSIONS OR GATE BURRS SHALL NOT EXCEED 0.152mm (.006") PER SIDE
  4. DIMENSION DOES NOT INCLUDE INTERLEAD FLASH OR PROTRUSIONS.  
INTERLEAD FLASH OR PROTRUSIONS SHALL NOT EXCEED 0.152mm (.006") PER SIDE
  5. LEAD COPLANARITY (BOTTOM OF LEADS AFTER FORMING) SHALL BE 0.102mm (.004") MAX

# PACKAGE DESCRIPTION

## S8 Package 8-Lead Plastic Small Outline (Narrow .150 Inch) (Reference LTC DWG # 05-08-1610)

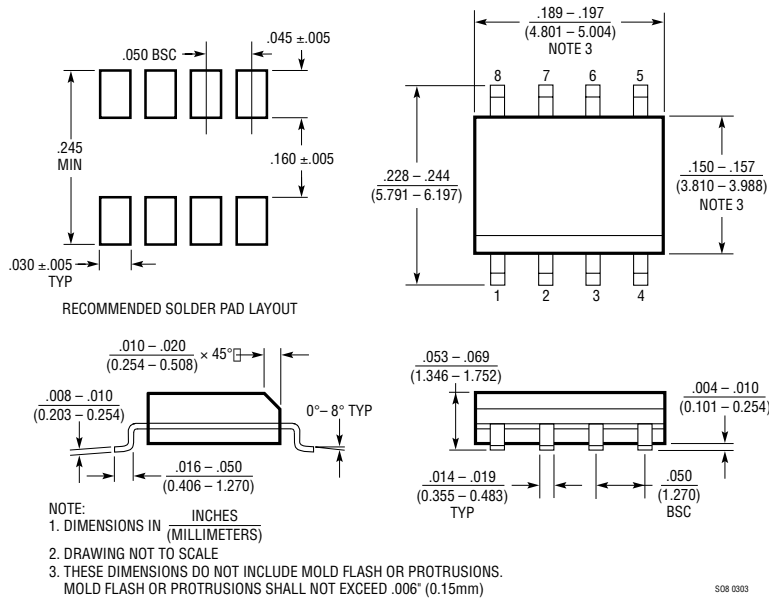

## MS Package 10-Lead Plastic MSOP (Reference LTC DWG # 05-08-1661)

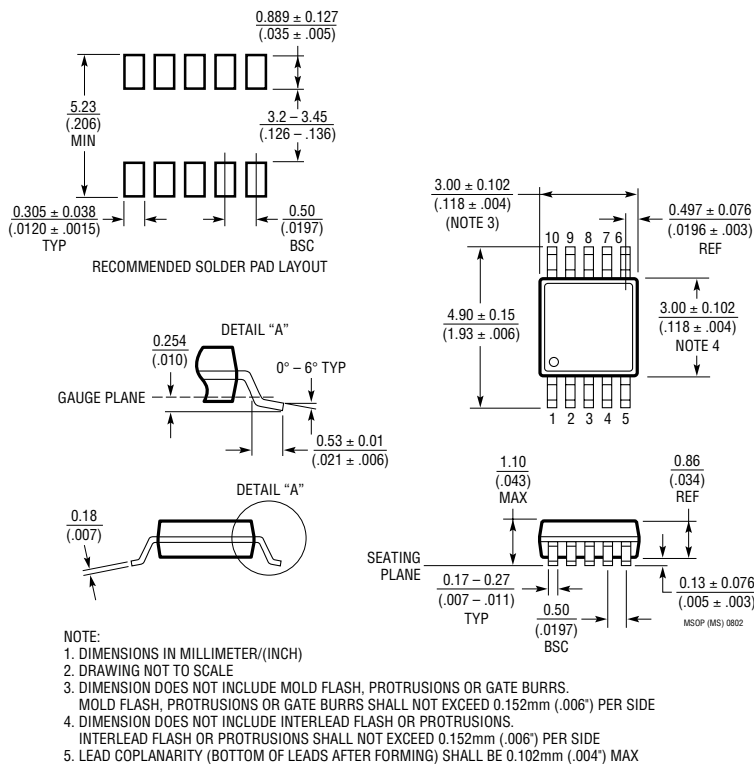

sn18645L 18645Lts

## TYPICAL APPLICATION

### Tiny 2-Chip Data Acquisition System

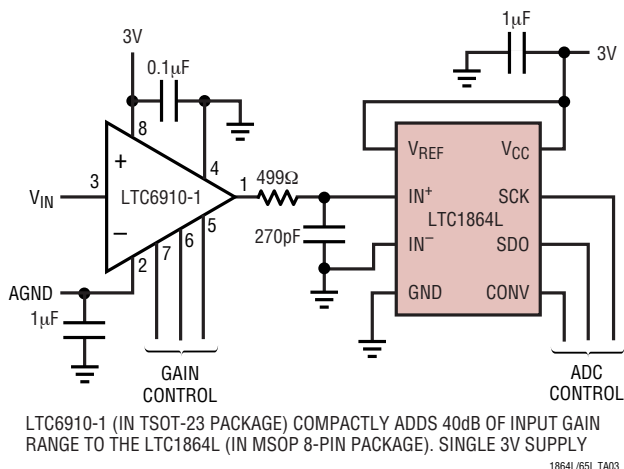

## RELATED PARTS

PART NUMBER	SAMPLE RATE	POWER DISSIPATION	DESCRIPTION
<b>12-Bit Serial I/O ADCs</b>			
LTC1860L/LTC1861L	150ksps	1.22mW	Pin Compatible with LTC1864L/LTC1865L
LTC1860/LTC1861	250ksps	4.25mW	Pin Compatible with LTC1864/LTC1865
<b>14-Bit Serial I/O ADCs</b>			
LTC1417	400ksps	20mW	16-Pin SSOP, Unipolar or Bipolar, Reference, 5V or ±5V
LTC1418	200ksps	15mW	Serial/Parallel I/O, Internal Reference, 5V or ±5V
<b>16-Bit Serial I/O ADCs</b>			
LTC1609	200ksps	65mW	Configurable Bipolar or Unipolar Input Ranges, 5V
LTC1864/LTC1865	250ksps	4.25mW	MSOP, SO-8, 1- and 2-Channel, 5V Supply
<b>References</b>			
LT1460	Micropower Precision Series Reference		Bandgap, 130µA Supply Current, 10ppm/°C, Available in SOT-23
LT1790	Micropower Low Dropout Reference		60µA Supply Current, 10ppm/°C, SOT-23
<b>Op Amps</b>			
LT1468/LT1469	Single/Dual 90MHz, 16-Bit Accurate Op Amps		22V/µs Slew Rate, 75µV/125µV Offset
LT1806/LT1807	Single/Dual 325MHz Low Noise Op Amps		140V/µs Slew Rate, 3.5nV/√Hz Noise, -80dBc Distortion
LT1809/LT1810	Single/Dual 180MHz Low Distortion Op Amps		350V/µs Slew Rate, -90dBc Distortion at 5MHz