



Brand of NTN Group

Technical data

SUC201

Insert bearings



Stainless steel insert, spherical outer diameter with locking pin, fixing by socket set screw, seal with slinger, food grease

VISUAL (S)

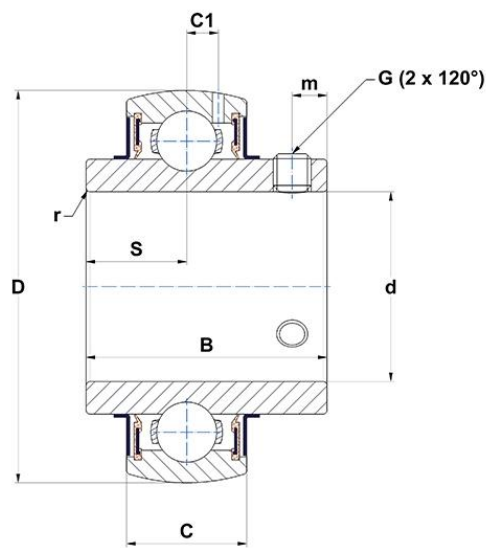

PRODUCT DEFINITION

Brand	SNR
B - Width of Inner Ring	31 mm
C - Width of Outer Ring	17 mm
C1 - Distance center of OR to center of lubrication zone	3,7 mm
d - Shaft diameter	12 mm
D - Outer diameter of OR	47 mm
G - Set screw size	M6x1
m - Distance to set screw	5 mm



NTN Europe

1 rue des Usines · BP 2017 · 74010 Annecy Cedex · France · Tel. +33 (0)4 50 65 30 00
S.A. au capital de 322 639 919 € · RCS ANNECY B 325 821 072 · Id. Fiscale : FR 48 325 821 072
SIRET 325 821 072 00015 · Code APE 2815 Z · Code NACE 28.15

PRODUCT DEFINITION

r - Radius Inner Ring	0.5
S - Distance front side/bearing centre	12,7 mm
f0 - Factor	13.2
SW - Wrench size	3 mm

PRODUCT PERFORMANCE

C - Dynamic load rating	12800000 mN
C0 - Static load rating	6600000 mN
Operating temperature min.	253,15 °K
Operating temperature max.	373,15 °K

OTHER FEATURES

Mass	0,2 kg
Recommended tightening torque for set screw	3.9 N-m

BEARING FREQUENCIES

BPFO - Over rolling frequency on outer ring (60 rpm)	3.06342182890855 Hz
BPMF - Over rolling frequency on inner (60 rpm)	4.93657817109145 Hz
BSF - Over rolling frequency on rolling element (60 rpm)	4.03672159895942 Hz
BRF - Rotational frequency - rolling element (60 rpm)	2.01836079947971 Hz
FTF - Rotational frequency - cage (60 rpm)	0.382927728613569 Hz

