

PNP Silicon AF Transistors

- For AF input stages and driver applications
- High current gain
- Low collector-emitter saturation voltage
- Low noise between 30 Hz and 15 kHz
- Complementary types: BCW60, BCX70 (NPN)
- Pb-free (RoHS compliant) package
- Qualified according AEC Q101

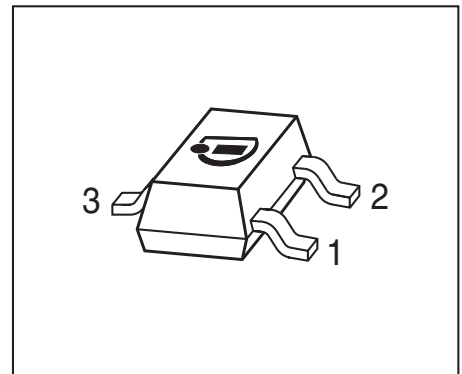

Type	Marking	Pin Configuration			Package
		1=B	2=E	3=C	
BCW61A	BAs	1=B	2=E	3=C	SOT23
BCW61B	BBs	1=B	2=E	3=C	SOT23
BCW61C	BCs	1=B	2=E	3=C	SOT23
BCW61D	BDs	1=B	2=E	3=C	SOT23
BCX71G	BGs	1=B	2=E	3=C	SOT23
BCX71H	BHs	1=B	2=E	3=C	SOT23
BCX71J	BJs	1=B	2=E	3=C	SOT23
BCX71K	BKs	1=B	2=E	3=C	SOT23

Maximum Ratings

Parameter	Symbol	Value	Unit
Collector-emitter voltage BCW61... BCX71...	V_{CEO}	32 45	V
Collector-base voltage BCW61... BCX71...	V_{CBO}	32 45	
Emitter-base voltage	V_{EBO}	5	
Collector current	I_C	100	mA
Peak collector current, $t_p \leq 10$ ms	I_{CM}	200	
Peak base current	I_{BM}	200	
Total power dissipation- $T_S \leq 71$ °C	P_{tot}	330	mW
Junction temperature	T_j	150	-
Storage temperature	T_{stg}	-65 ... 150	°C

Thermal Resistance

Parameter	Symbol	Value	Unit
Junction - soldering point ¹⁾	R_{thJS}	≤ 240	K/W

¹⁾For calculation of R_{thJA} please refer to Application Note AN077 (Thermal Resistance Calculation)

Electrical Characteristics at $T_A = 25^\circ\text{C}$, unless otherwise specified

Parameter	Symbol	Values			Unit
		min.	typ.	max.	
DC Characteristics					
Collector-emitter breakdown voltage $I_C = 10\text{ mA}$, $I_B = 0$, BCW61... $I_C = 10\text{ mA}$, $I_B = 0$, BCX71...	$V_{(BR)CEO}$	32 45	- -	- -	V
Collector-base breakdown voltage $I_C = 10\text{ }\mu\text{A}$, $I_E = 0$, BCW61... $I_C = 10\text{ }\mu\text{A}$, $I_E = 0$, BCX71...	$V_{(BR)CBO}$	32 45	- -	- -	
Emitter-base breakdown voltage $I_E = 1\text{ }\mu\text{A}$, $I_C = 0$	$V_{(BR)EBO}$	5	-	-	
Collector-base cutoff current $V_{CB} = 32\text{ V}$, $I_E = 0$ $V_{CB} = 45\text{ V}$, $I_E = 0$ $V_{CB} = 32\text{ V}$, $I_E = 0$, $T_A = 150^\circ\text{C}$, BCW61... $V_{CB} = 45\text{ V}$, $I_E = 0$, $T_A = 150^\circ\text{C}$, BCX71...	I_{CBO}	- - - -	- - - -	0.02 0.02 20 20	μA
Emitter-base cutoff current $V_{EB} = 4\text{ V}$, $I_C = 0$	I_{EBO}	-	-	20	nA
DC current gain ¹⁾ $I_C = 10\text{ }\mu\text{A}$, $V_{CE} = 5\text{ V}$, h_{FE} -grp. A/G $I_C = 10\text{ }\mu\text{A}$, $V_{CE} = 5\text{ V}$, h_{FE} -grp. B/H $I_C = 10\text{ }\mu\text{A}$, $V_{CE} = 5\text{ V}$, h_{FE} -grp. C/J $I_C = 10\text{ }\mu\text{A}$, $V_{CE} = 5\text{ V}$, h_{FE} -grp. D/K $I_C = 2\text{ mA}$, $V_{CE} = 5\text{ V}$, h_{FE} -grp. A/G $I_C = 2\text{ mA}$, $V_{CE} = 5\text{ V}$, h_{FE} -grp. B/H $I_C = 2\text{ mA}$, $V_{CE} = 5\text{ V}$, h_{FE} -grp. C/J $I_C = 2\text{ mA}$, $V_{CE} = 5\text{ V}$, h_{FE} -grp. D/K $I_C = 50\text{ mA}$, $V_{CE} = 1\text{ V}$, h_{FE} -grp. A/G $I_C = 50\text{ mA}$, $V_{CE} = 1\text{ V}$, h_{FE} -grp. B/H $I_C = 50\text{ mA}$, $V_{CE} = 1\text{ V}$, h_{FE} -grp. C/J $I_C = 50\text{ mA}$, $V_{CE} = 1\text{ V}$, h_{FE} -grp. D/K	h_{FE}	20 30 40 100 120 180 250 380 60 80 100 110	140 200 300 460 170 250 350 500 - - - -	- - - - 220 310 460 630 - - - -	-

DC Electrical Characteristics

Parameter	Symbol	Values			Unit
		min.	typ.	max.	
Characteristics					
Collector-emitter saturation voltage ¹⁾ $I_C = 10 \text{ mA}, I_B = 0.25 \text{ mA}$ $I_C = 50 \text{ mA}, I_B = 1.25 \text{ mA}$	V_{CEsat}	- -	0.12 0.2	0.25 0.55	V
Base emitter saturation voltage ¹⁾ $I_C = 10 \text{ mA}, I_B = 0.25 \text{ mA}$ $I_C = 50 \text{ mA}, I_B = 1.25 \text{ mA}$	V_{BEsat}	- -	0.7 0.83	0.85 1.05	
Base-emitter voltage ¹⁾ $I_C = 10 \text{ }\mu\text{A}, V_{CE} = 5 \text{ V}$ $I_C = 2 \text{ mA}, V_{CE} = 5 \text{ V}$ $I_C = 50 \text{ mA}, V_{CE} = 1 \text{ V}$	$V_{BE(ON)}$	- 0.55 -	0.52 0.65 0.78	- 0.75 -	

¹⁾Pulse test: $t < 300\mu\text{s}$; $D < 2\%$

AC Characteristics					
Transition frequency $I_C = 20 \text{ mA}, V_{CE} = 5 \text{ V}, f = 100 \text{ MHz}$	f_T	-	250	-	MHz
Collector-base capacitance $V_{CB} = 10 \text{ V}, f = 1 \text{ MHz}$	C_{cb}	-	1.5	-	pF
Emitter-base capacitance $V_{EB} = 0.5 \text{ V}, f = 1 \text{ MHz}$	C_{eb}	-	8	-	
Short-circuit input impedance $I_C = 2 \text{ mA}, V_{CE} = 5 \text{ V}, f = 1 \text{ kHz}, h_{FE}\text{-grp. A/B}$ $I_C = 2 \text{ mA}, V_{CE} = 5 \text{ V}, f = 1 \text{ kHz}, h_{FE}\text{-grp. B/H}$ $I_C = 2 \text{ mA}, V_{CE} = 5 \text{ V}, f = 1 \text{ kHz}, h_{FE}\text{-grp. C/J}$ $I_C = 2 \text{ mA}, V_{CE} = 5 \text{ V}, f = 1 \text{ kHz}, h_{FE}\text{-grp. D/K}$	h_{11e}	-	2.7 3.6 4.5 7.5	-	k Ω
Open-circuit reverse voltage transf. ratio $I_C = 2 \text{ mA}, V_{CE} = 5 \text{ V}, f = 1 \text{ kHz}, h_{FE}\text{-grp. A/B}$ $I_C = 2 \text{ mA}, V_{CE} = 5 \text{ V}, f = 1 \text{ kHz}, h_{FE}\text{-grp. B/H}$ $I_C = 2 \text{ mA}, V_{CE} = 5 \text{ V}, f = 1 \text{ kHz}, h_{FE}\text{-grp. C/J}$ $I_C = 2 \text{ mA}, V_{CE} = 5 \text{ V}, f = 1 \text{ kHz}, h_{FE}\text{-grp. D/K}$	h_{12e}	-	1.5 2 2 3	-	10^{-4}
Short-circuit forward current transf. ratio $I_C = 2 \text{ mA}, V_{CE} = 5 \text{ V}, f = 1 \text{ kHz}, h_{FE}\text{-grp. A/B}$ $I_C = 2 \text{ mA}, V_{CE} = 5 \text{ V}, f = 1 \text{ kHz}, h_{FE}\text{-grp. B/H}$ $I_C = 2 \text{ mA}, V_{CE} = 5 \text{ V}, f = 1 \text{ kHz}, h_{FE}\text{-grp. C/J}$ $I_C = 2 \text{ mA}, V_{CE} = 5 \text{ V}, f = 1 \text{ kHz}, h_{FE}\text{-grp. D/K}$	h_{21e}	-	200 260 330 520	-	-
Open-circuit output admittance $I_C = 2 \text{ mA}, V_{CE} = 5 \text{ V}, f = 1 \text{ kHz}, h_{FE}\text{-grp. A/B}$ $I_C = 2 \text{ mA}, V_{CE} = 5 \text{ V}, f = 1 \text{ kHz}, h_{FE}\text{-grp. B/H}$ $I_C = 2 \text{ mA}, V_{CE} = 5 \text{ V}, f = 1 \text{ kHz}, h_{FE}\text{-grp. C/J}$ $I_C = 2 \text{ mA}, V_{CE} = 5 \text{ V}, f = 1 \text{ kHz}, h_{FE}\text{-grp. D/K}$	h_{22e}	-	18 24 30 50	-	μS
Noise figure $I_C = 200 \mu\text{A}, V_{CE} = 5 \text{ V}, f = 1 \text{ kHz},$ $\Delta f = 200 \text{ Hz}, R_S = 2 \text{ k}\Omega, h_{FE}\text{-grp. A/K}$	F	-	2	-	dB

DC current gain $h_{FE} = f(I_C)$

$V_{CE} = 5\text{ V}$

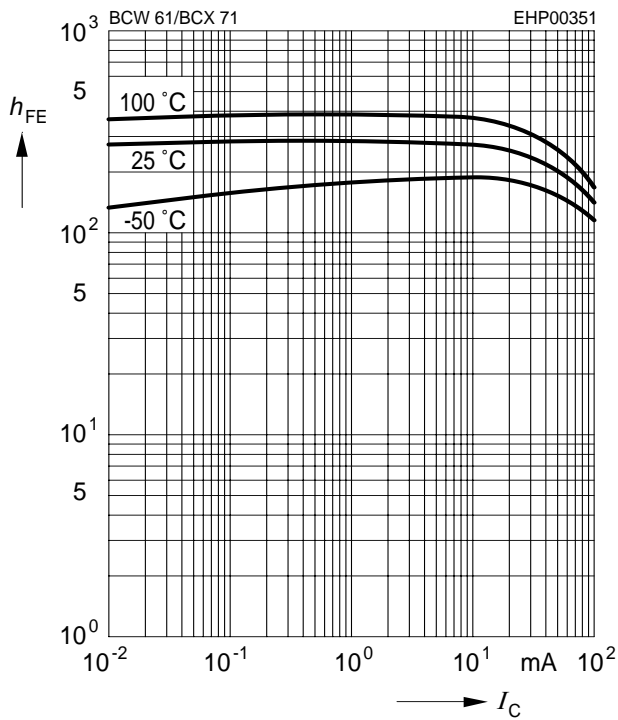

Collector-emitter saturation voltage

$I_C = f(V_{CEsat}), h_{FE} = 40$

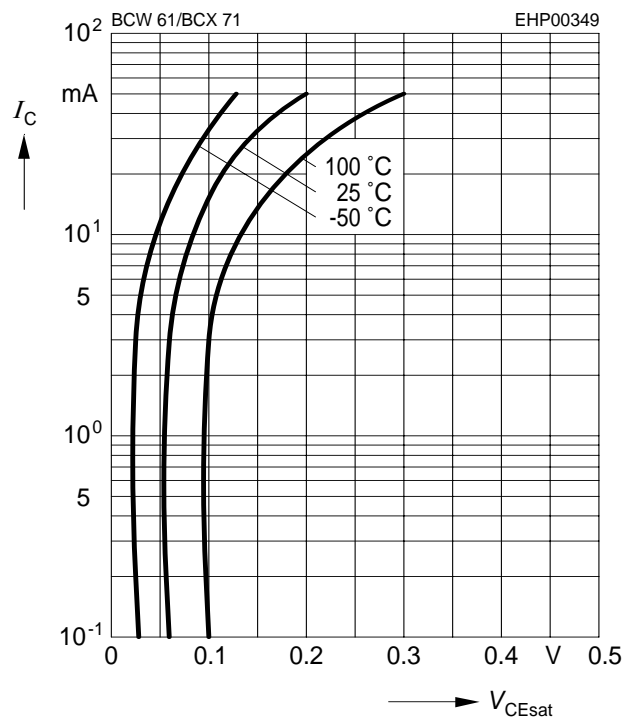

Base-emitter saturation voltage

$I_C = f(V_{BEsat}), h_{FE} = 40$

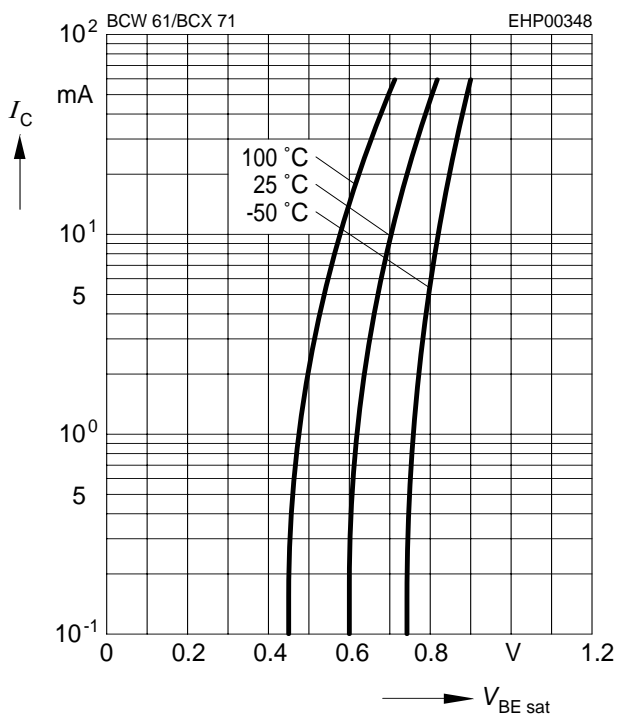

Collector current $I_C = f(V_{BE})$

$V_{CE} = 5\text{ V}$

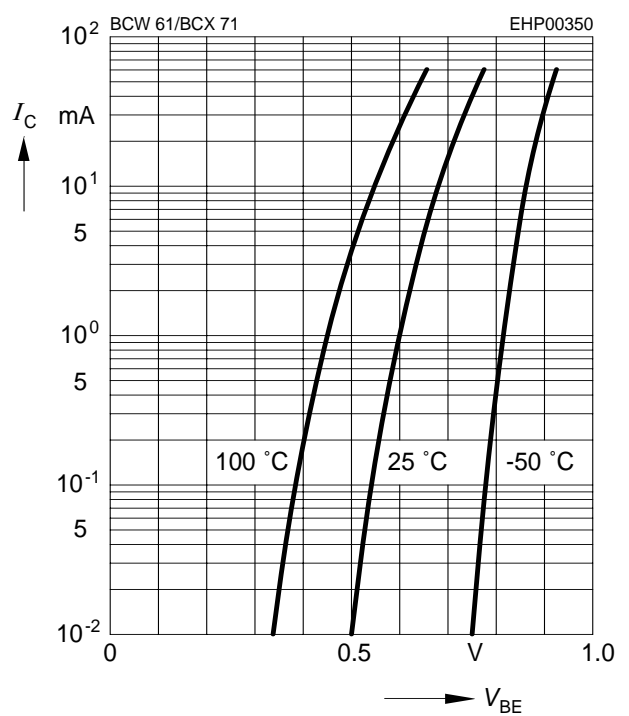

Collector cutoff current $I_{CBO} = f(T_A)$

$V_{CB} = V_{CEmax}$

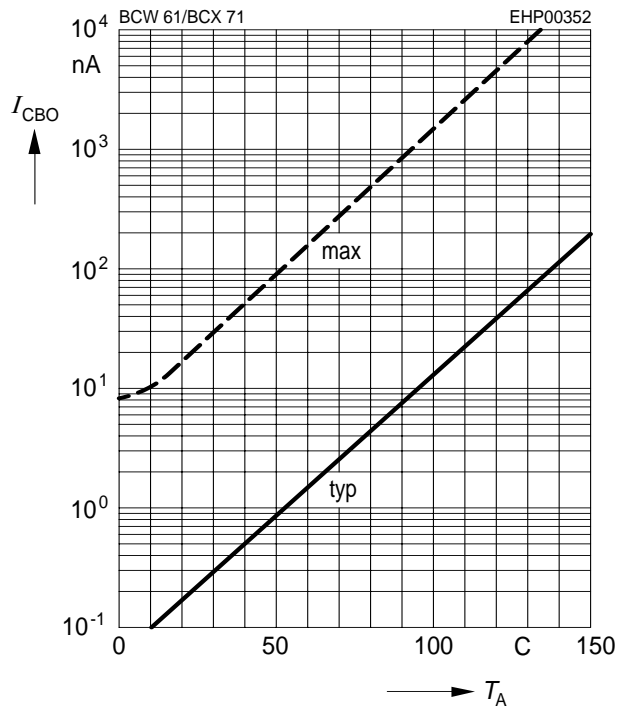

Transition frequency $f_T = f(I_C)$

$V_{CE} = \text{parameter in V, } f = 2 \text{ GHz}$

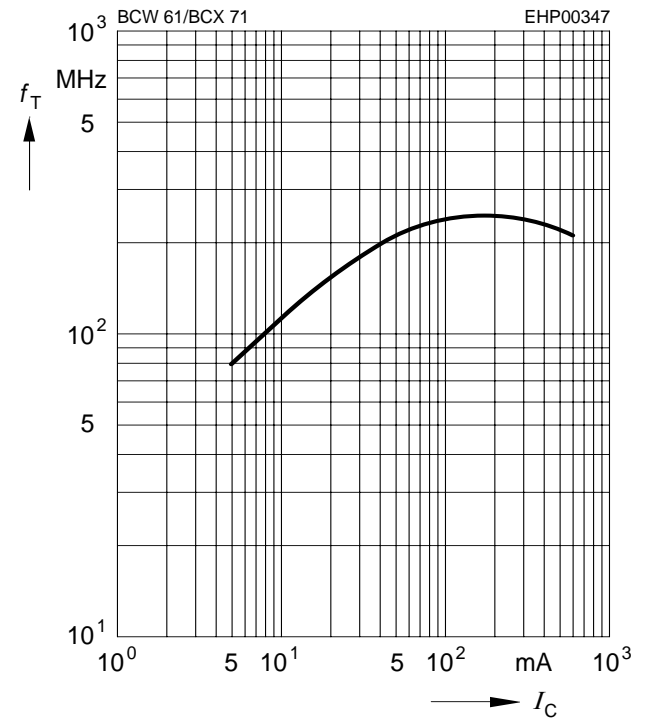

Collector-base capacitance $C_{cb} = f(V_{CB})$

Emitter-base capacitance $C_{eb} = f(V_{EB})$



Total power dissipation $P_{tot} = f(T_S)$

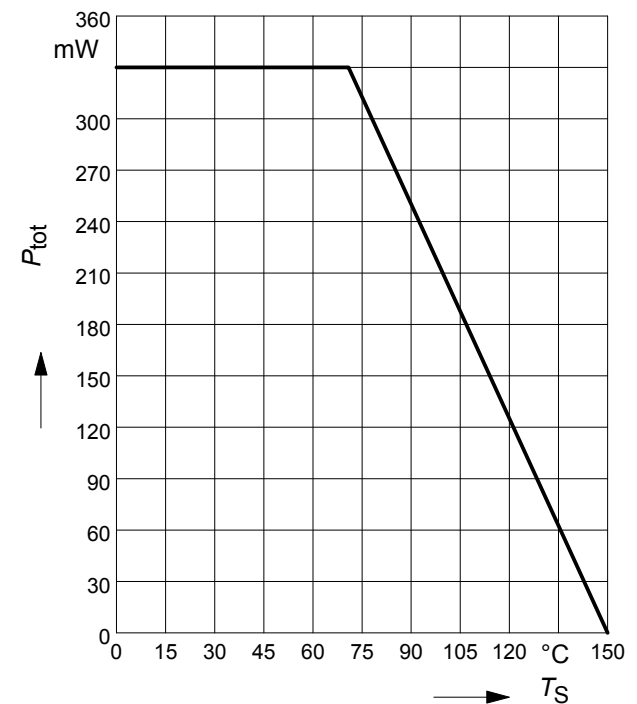

Permissible Pulse Load

$$P_{\text{totmax}}/P_{\text{totDC}} = f(t_p)$$



h parameter $h_e = f(I_C)$ normalized

$$V_{\text{CE}} = 5\text{V}$$



h parameter $h_e = f(V_{\text{CE}})$ normalized

$$I_C = 2\text{mA}$$

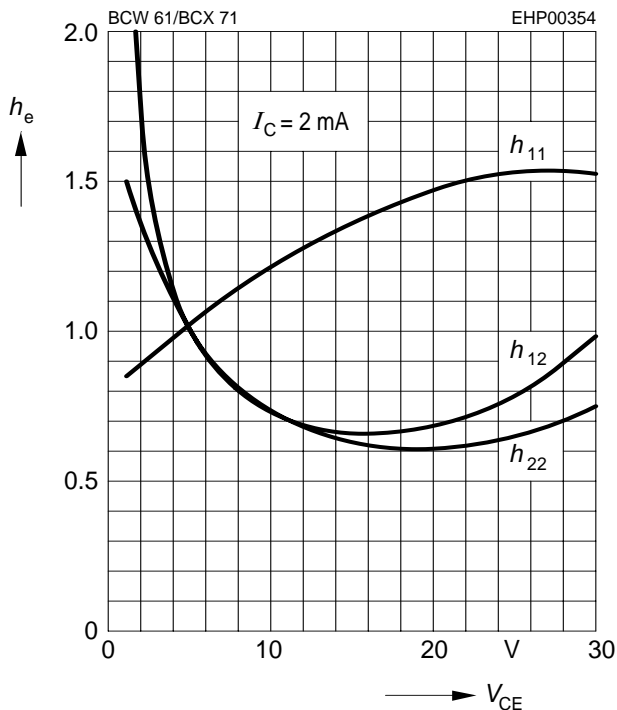

Noise figure $F = f(V_{\text{CE}})$

$$I_C = 0.2\text{mA}, R_S = 2\text{k}\Omega, f = 1\text{kHz}$$

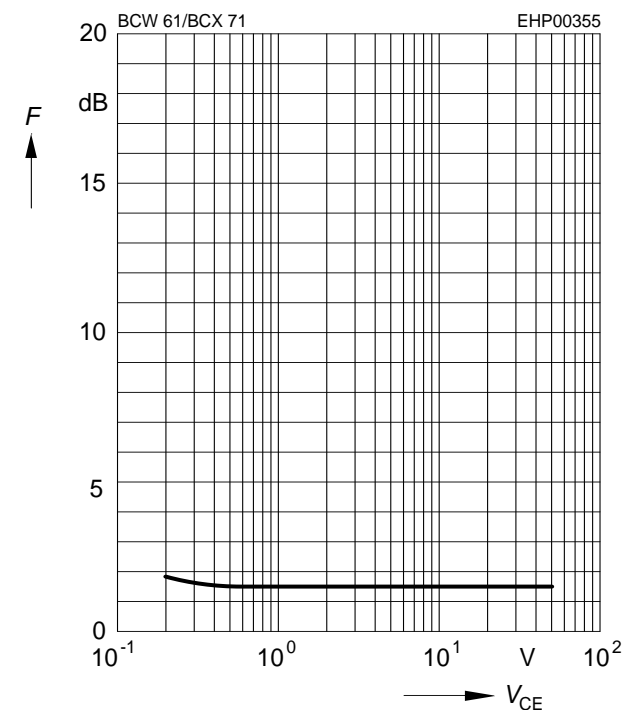

Noise figure $F = f(f)$

$V_{CE} = 5V, Z_S = Z_{Sopt}$

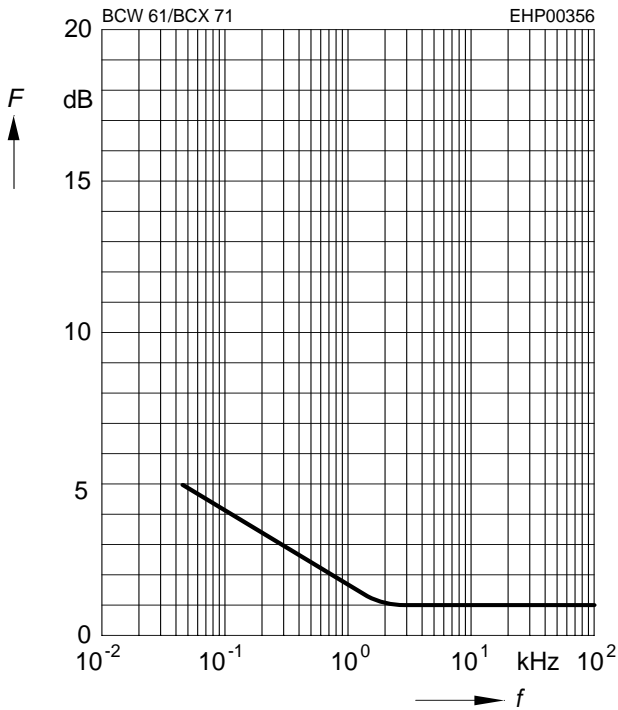

Noise figure $F = f(I_C)$

$V_{CE} = 5V, f = 120Hz$

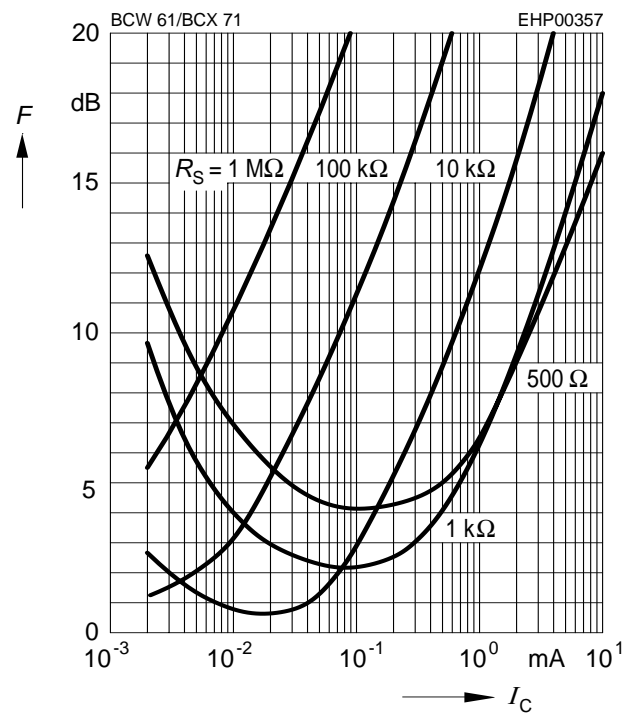

Noise figure $F = f(I_C)$

$V_{CE} = 5V, f = 1kHz$

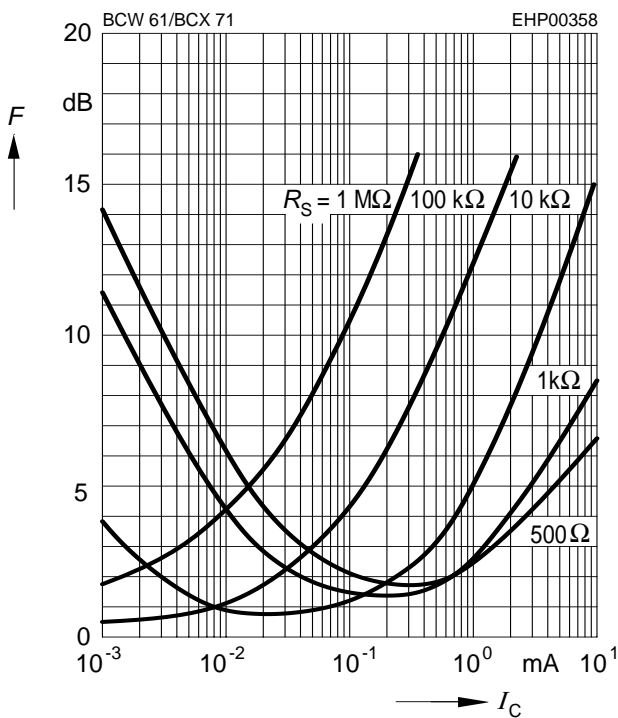

Noise figure $F = f(I_C)$

$V_{CE} = 5V, f = 10kHz$

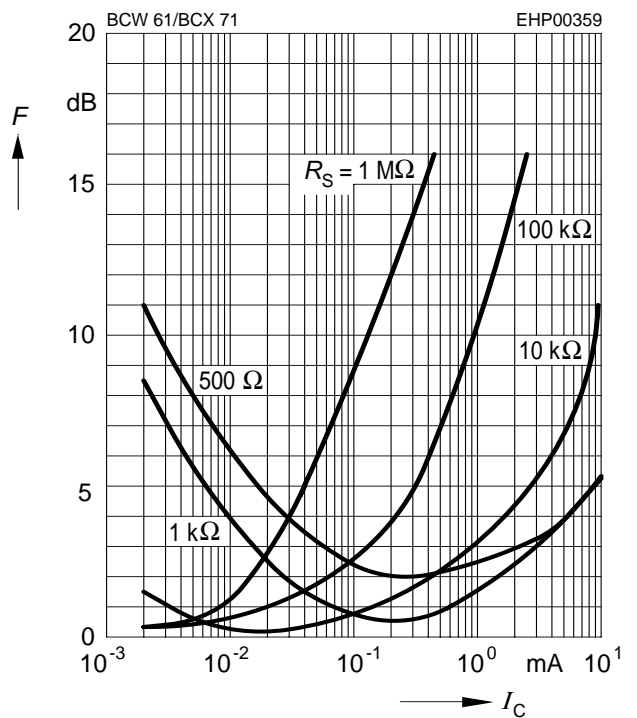

Package Outline



1) Lead width can be 0.6 max. in dambar area

Foot Print



Marking Layout (Example)



Standard Packing

Reel \varnothing 180 mm = 3.000 Pieces/Reel
 Reel \varnothing 330 mm = 10.000 Pieces/Reel



Edition 2009-11-16

**Published by
Infineon Technologies AG
81726 Munich, Germany**

**© 2009 Infineon Technologies AG
All Rights Reserved.**

Legal Disclaimer

The information given in this document shall in no event be regarded as a guarantee of conditions or characteristics. With respect to any examples or hints given herein, any typical values stated herein and/or any information regarding the application of the device, Infineon Technologies hereby disclaims any and all warranties and liabilities of any kind, including without limitation, warranties of non-infringement of intellectual property rights of any third party.

Information

For further information on technology, delivery terms and conditions and prices, please contact the nearest Infineon Technologies Office ([<www.infineon.com>](http://www.infineon.com)).

Warnings

Due to technical requirements, components may contain dangerous substances. For information on the types in question, please contact the nearest Infineon Technologies Office.

Infineon Technologies components may be used in life-support devices or systems only with the express written approval of Infineon Technologies, if a failure of such components can reasonably be expected to cause the failure of that life-support device or system or to affect the safety or effectiveness of that device or system. Life support devices or systems are intended to be implanted in the human body or to support and/or maintain and sustain and/or protect human life. If they fail, it is reasonable to assume that the health of the user or other persons may be endangered.