



Models Available

Features/Benefits

- Compact size—small footprint
- Single and double pole models
- PC and panel mount options available

Typical Applications

- Hand-held telecommunications
- Instrumentation
- Medical equipment

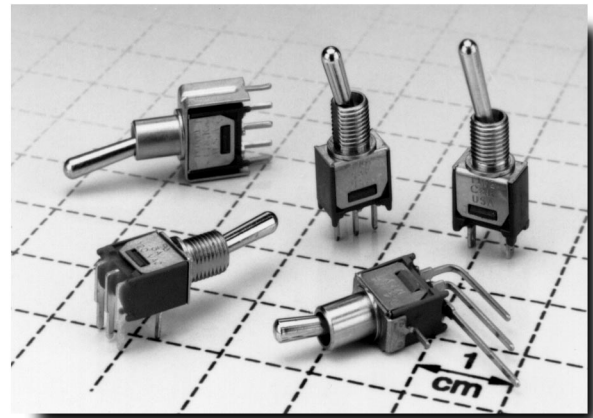

A

Toggle

Build-A-Switch

Our easy Build-A-Switch concept allows you to mix and match options to create the switch you need. Below is a complete listing of options shown in catalog. To order, simply select desired option from each category and place in the appropriate box. Switches with standard options are shown on pages A-40 and A-41. Available options are shown and described on pages A-41 thru A-45. For additional options not shown in catalog, consult Customer Service Center. All models have epoxy terminal seal and are compatible with all "bottom-wash" PCB cleaning methods.

Typical Example: T 1 0 1 — S — H — Z — Q — E —

Switch Function

- T101** (STD.) SPDT On-None-On
- T103** (STD.) SPDT On-Off-On
- T105** (STD.) SPDT Mom.-Off-Mom.
- T201** (STD.) DPDT On-None-On
- T102** SPST Off-None-On
- T107** SPDT On-Off-Mom.
- T108** SPDT On-None-Mom.
- T203** DPDT On-Off-On
- T205** DPDT Mom.-Off-Mom.
- T207** DPDT On-Off-Mom.
- T208** DPDT On-None-Mom.
- T211** DPDT On-On-On

Actuator

- M** (STD.) .210" high
- P3** (STD.) Flatted, anti-rotation, .450" high
- S** (STD.) .370" high
- K** Locking lever
- K1** Locking lever
- L** .290" high
- L1** .620" high
- M1** .220" high
- S1** .410" high

Bushing

- H** (STD.) .220" high, threaded, flat
- H9** (STD.) .220" high, unthreaded, flat
- CF** Splashproof, .310" high, threaded, flat
- D9** .260" high, unthreaded, keyway
- K9** .310" high, unthreaded, keyway
- T** .310" high, threaded, flat
- T9** .310" high, unthreaded, flat
- TD** .260" high, threaded, keyway
- TK** .310" high, threaded, keyway
- Y** .220" high, threaded, keyway
- Y9** .220" high, unthreaded, keyway

Terminations

- A** (STD.) Right angle, PC thru-hole
- AV** (STD.) Vertical right angle, PC thru-hole
- C** (STD.) PC Thru-hole
- V3** (STD.) Vertical mount V-bracket
- Z** (STD.) Solder lug
- W** Wire wrap

Contact Material

- B** (STD.) Gold
- Q** (STD.) Silver
- K** Gold
- M** Silver
- G** Gold over silver
- L** Gold over silver

Seal

- E** (STD.) Epoxy

Locking Lever Actuator Finish

- NONE** (STD.) Natural aluminum
- 2** Black
- 3** Red
- 7** Blue

Specifications

CONTACT RATING: B contact material: 0.4 VA max. @ 20 V AC or DC max. Q contact material (TX01 models): 3 AMPS @ 120 V AC or 28 V DC. All other models: 2 AMPS @ 120 V AC or 28 V DC. See page A-45 for additional ratings.

ELECTRICAL LIFE: TX01 models: 60,000 make-and-break cycles at full load. All other models: 30,000 cycles.

CONTACT RESISTANCE: Below 20 milliohms typ. initial @ 2-4 V DC, 100 mA, for both silver and gold plated contacts.

INSULATION RESISTANCE: 10⁹ ohms min.

DIELECTRIC STRENGTH: 1000 V RMS min. @ sea level.

OPERATING TEMPERATURE: -30°C to 85°C.

SOLDERABILITY: Per MIL-STD-202F method 208D, or EIA RS-186E method 9 (1 hour steam aging).

NOTE: Specifications and materials listed above are for switches with standard options. For information on specific and custom switches, consult Customer Service Center.

Materials

CASE: Glass filled nylon 6/6, flame retardant, heat stabilized or diallyl phthalate (DAP), (UL 94V-0).

ACTUATOR: Brass, chrome plated.

BUSHING: Brass, nickel plated.

HOUSING: Stainless steel.

SWITCH SUPPORT: Brass, tin plated.

END CONTACTS: B contact material: Copper alloy, with gold plate over nickel plate. Q contact material: Coin silver, silver plated. See page A-45 for additional contact materials.

CENTER CONTACTS & TERMINALS: B contact material: Copper alloy, with gold plate over nickel plate. Q contact material: Copper alloy, silver plated. See page A-45 for additional contact materials.

TERMINAL SEAL: Epoxy.

HARDWARE: Nut & Locking Ring: Brass, nickel plated.
Lockwasher: Steel, nickel plated.

T Series Subminiature Toggle Switches



Toggle

SWITCHES WITH STANDARD OPTIONS



T101SHZQE
SPDT

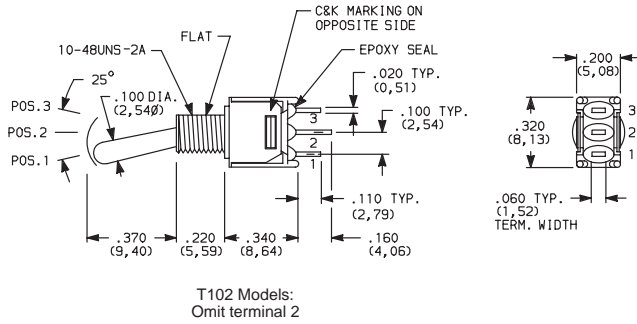

PART NUMBER	NO. POLES	POS. 1	POS. 2	POS. 3
T101SHZQE	SPDT	ON	NONE	ON

NOTE: For PC termination, replace 'Z' with 'C'.
For panel mounting information, see page A-42.
For PC mounting information, see page A-43.



T201SHZQE
DPDT

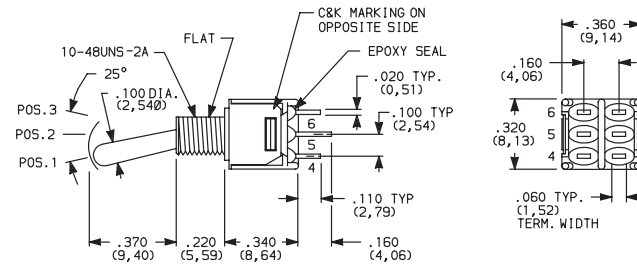

PART NUMBER	NO. POLES	POS. 1	POS. 2	POS. 3
T201SHZQE	DPDT	ON	NONE	ON

NOTE: For PC termination, replace 'Z' with 'C'.
For panel mounting information, see page A-42.
For PC mounting information, see page A-43.



T101MH9ABE
Horizontal Actuation
SPDT

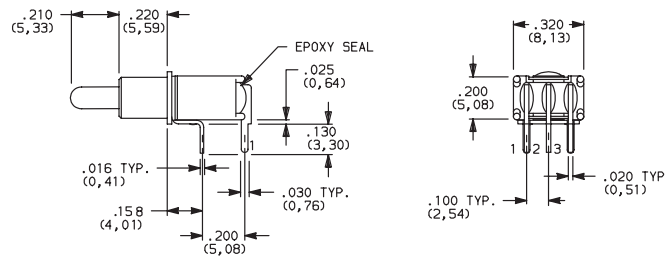

PART NUMBER	NO. POLES	POS. 1	POS. 2	POS. 3
T101MH9ABE	SPDT	ON	NONE	ON
T103MH9ABE		ON	OFF	ON
T105MH9ABE		MOM.	OFF	MOM.
T107MH9ABE		ON	OFF	MOM.
T108MH9ABE		ON	NONE	MOM.

NOTE: For PC mounting information, see page A-43.
MOM. = Momentary

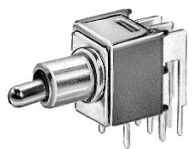

T201MH9ABE
Horizontal Actuation
DPDT

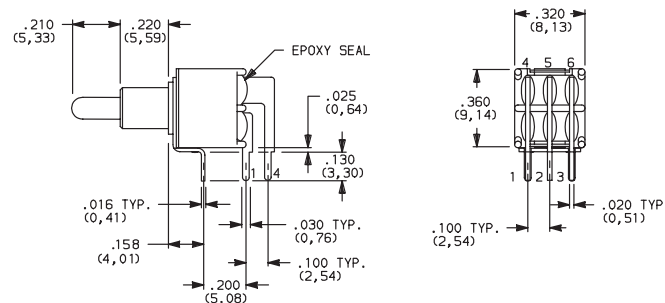

PART NUMBER	NO. POLES	POS. 1	POS. 2	POS. 3
T201MH9ABE	DPDT	ON	NONE	ON

NOTE: For PC mounting information, see page A-43.

SWITCH WITH STANDARD OPTIONS

PART NUMBER	NO. POLES	POS. 1	POS. 2	POS. 3
T101MH9AVBE	SPDT	ON	NONE	ON

NOTE: For PC mounting information, see page A-44.

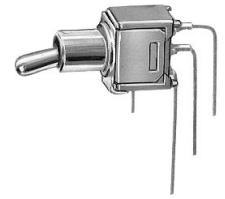
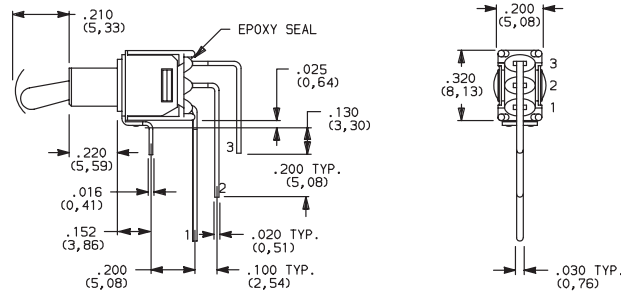

T101MH9AVBE
Vertical Actuation
SPDT



SWITCH FUNCTION

NO. POLES	MODEL NO.	SWITCH FUNCTION			CONNECTED TERMINALS			SCHEMATIC
		POS. 1	POS. 2	POS. 3	POS. 1	POS. 2	POS. 3	
SP	T101 (STD.)	ON	NONE	ON	2-3	OPEN	2-1	
	T103 (STD.)	ON	OFF	ON				
	T105 (STD.)	MOM.	OFF	MOM.				
	T107	ON	OFF	MOM.				
	T108	ON	NONE	MOM.				
	T102	OFF	NONE	ON				
DP	T201 (STD.)	ON	NONE	ON	2-3,5-6	OPEN	2-1,5-4	
	T203	ON	OFF	ON				
	T205	MOM.	OFF	MOM.				
	T207	ON	OFF	MOM.				
	T208	ON	NONE	MOM.				
	T211*	ON	ON	ON				

MOM. = Momentary

* Wiring for 3-way switch, see page L-29.

All models with all options when ordered with G, L, M or Q contact material.

ACTUATOR

M (STD.) .210" HIGH

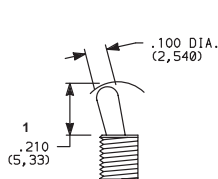

Standard with A, AV or V3 terminations.

S (STD.) .370" HIGH

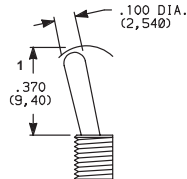

Standard with Z, C or W terminations.

M1 .220" HIGH

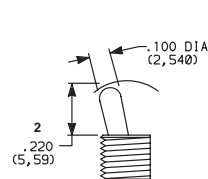

S1 .410" HIGH

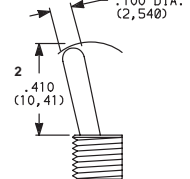

L .290" HIGH

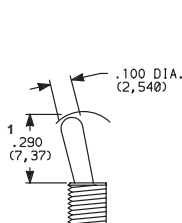

L1 .620" HIGH

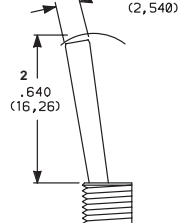

P3 (STD.) ANTI-ROTATION, FLATTED, .450" HIGH

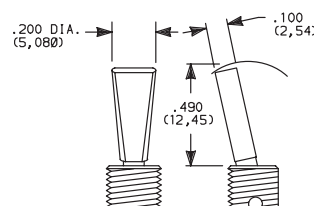

Available with T & T9 bushings only.

1 Actuator shown with standard H bushing. Subtract .040 (1,02) for TD and D9 bushings, subtract .090 (2,29) for T, T9, TK, K9 & CF bushings.

2 Actuators shown with T, TK & CF bushings, add .050 (1,27) for TD and D9 bushings, add .090 (2,29) for H, H9, Y & Y9 bushings.

NOTE: Dress nut part number 709901201 supplied standard with threaded bushing. All actuators have chrome finish (except K & K1). No finish selection required.

T Series Subminiature Toggle Switches



Toggle
A

ACTUATOR ACTUATOR FINISH

K LOCKING LEVER

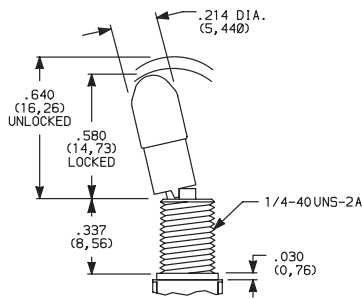

K1 LOCKING LEVER

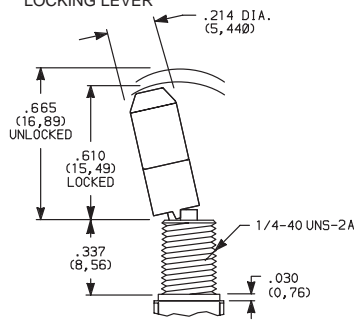

Locking Positions



-01 & -02 Models
2 Position lock



-03 & -11 Models
3 Position lock



-08 Models
1 Position lock

Not available with CF bushing option.

NOTE: Keyway on right side. To prevent accidental actuation, toggles must be lifted before being actuated. When released, toggles again lock in place. Overtightening mounting nut may cause actuator to bind.

Bushing option code not required. Not available with TX05 & TX07 models.

OPTION CODE	K & K1 ACTUATOR CAP FINISH
NONE	(STD.) NATURAL AL.
2	BLACK ANODIZED AL.
3	RED ANODIZED AL.
7	BLUE ANODIZED AL.

BUSHING

H (STD.) .220" HIGH THREADED, FLAT

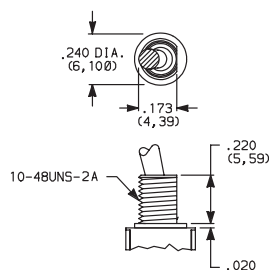

H standard with C, W & Z terminations.
H9 standard with A, AV & V3 terminations.

Y .220" HIGH THREADED, KEYWAY

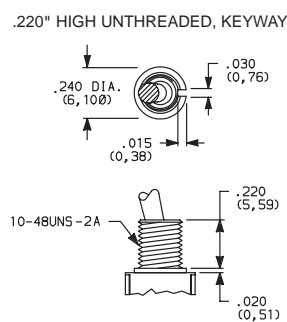

T .310" HIGH THREADED, FLAT

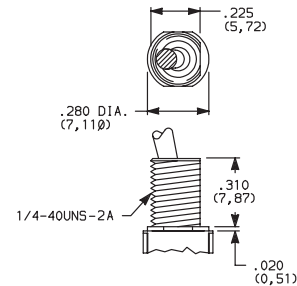

TK .310" HIGH THREADED, KEYWAY

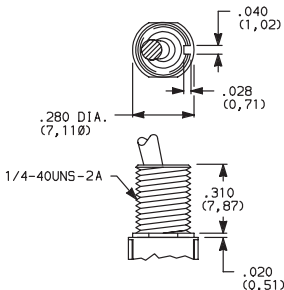

TD .260" HIGH THREADED, KEYWAY

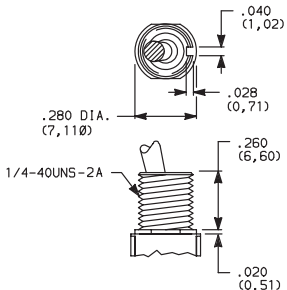

CF SPLASHPROOF, .310" HIGH THREADED, FLAT

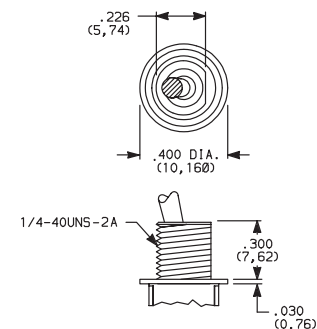

IP67 Degree of protection.
Internal o-ring actuator seal and external bushing seal washer standard.

Not available with K Locking lever option.

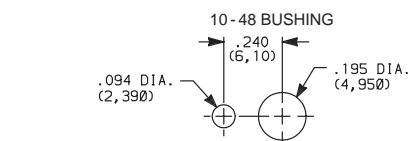

With Standard Locking Ring

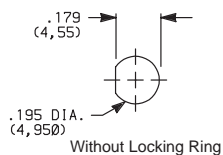

Without Locking Ring

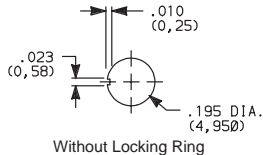

Without Locking Ring

PANEL MOUNTING

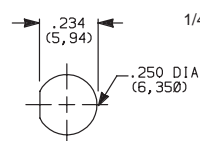

With Standard Locking Ring

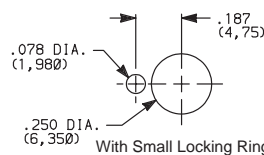

With Small Locking Ring

1/4 IN. BUSHING

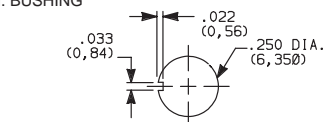

With Standard Locking Ring

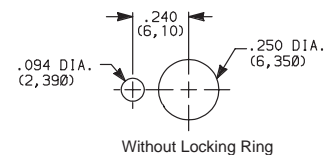

Without Locking Ring

TERMINATIONS



A

Toggle

Z (STD.) SOLDER LUG

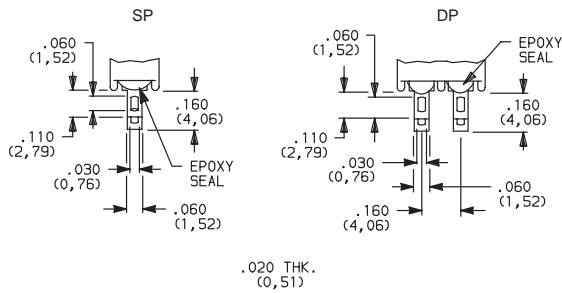

Not available with K, L or M contact materials.

C (STD.) PC THRU-HOLE

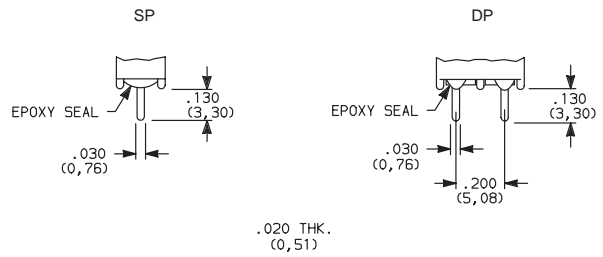

W WIRE WRAP

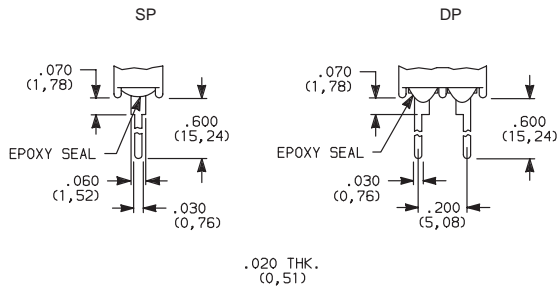

PC MOUNTING

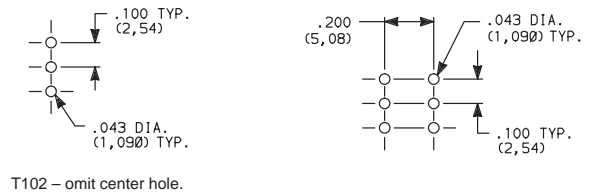

A (STD.) RIGHT ANGLE, PC THRU-HOLE

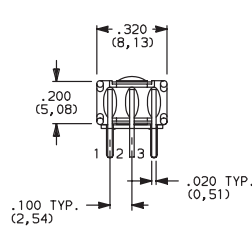
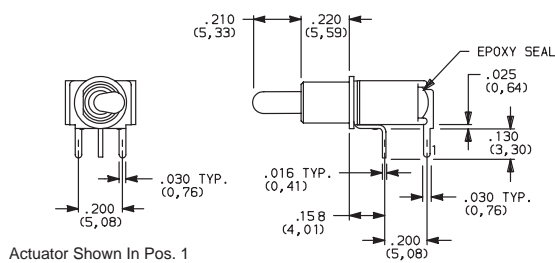

PC MOUNTING

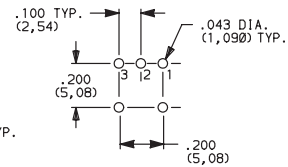

T101MH9ABE
Horizontal Actuation
SPDT

Not available with T102 model.

A (STD.) RIGHT ANGLE, PC THRU-HOLE

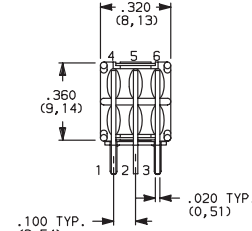
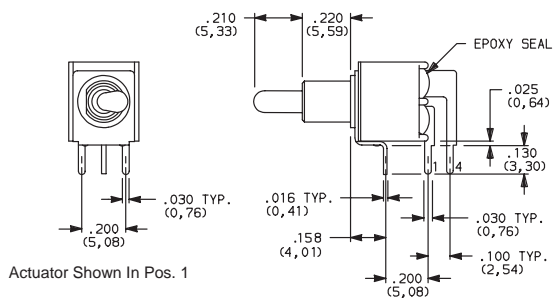

PC MOUNTING

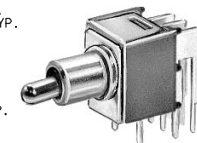
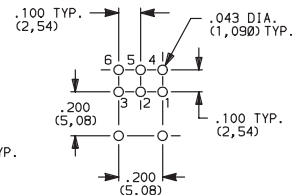

T201MH9ABE
Horizontal Actuation
DPDT

T Series Subminiature Toggle Switches



TERMINATIONS

AV (STD.) VERTICAL RIGHT ANGLE, PC THRU-HOLE

A

Toggle

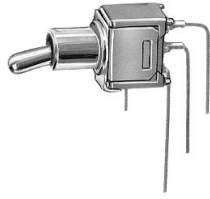

T101MH9AVBE
Vertical Actuation
SPDT

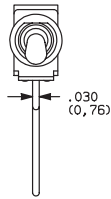

Actuator Shown In Pos. 1

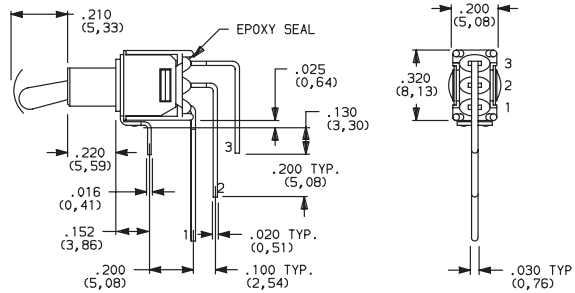

T102 Models: Omit terminal 2

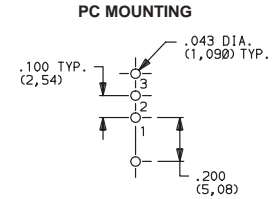

NOTE: Terminal bend radii and lead-in manufacturing option.

AV (STD.) VERTICAL RIGHT ANGLE, PC THRU-HOLE

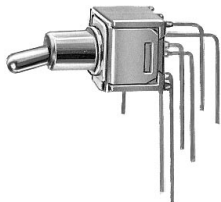

T201MH9AVBE
Vertical Actuation
DPDT

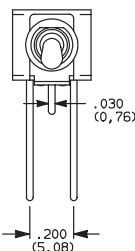

Actuator Shown In Pos. 1

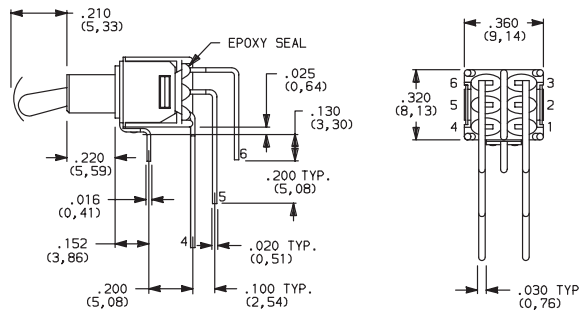

PC MOUNTING

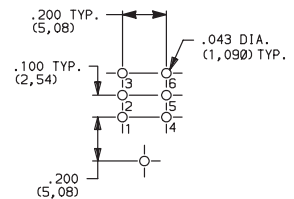

NOTE: Terminal bend radii and lead-in manufacturing option.

V3 (STD.) VERTICAL MOUNT, V-BRACKET



T101MH9V3BE
SPDT

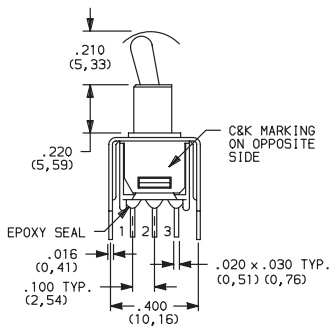

Actuator Shown In Pos. 1

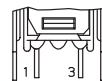

T102 Models:
Omit terminal 2

PC MOUNTING

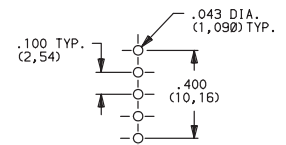

T102 Models:
Omit center hole.

TERMINATIONS

V3 (STD.) VERTICAL MOUNT, V-BRACKET



T201MH9V3BE
DPDT

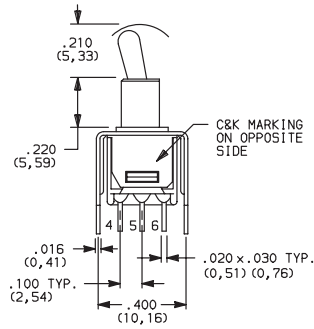

Actuator Shown In Pos. 1

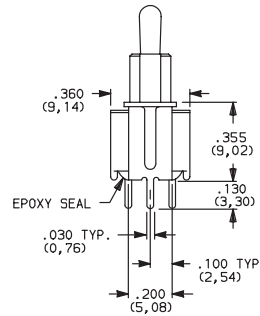

PC MOUNTING

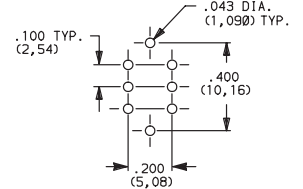

CONTACT MATERIAL

OPTION CODE	CONTACT MATERIAL	TERMINAL PLATING	RATINGS	
B (STD.)	GOLD ¹	GOLD ¹	LOW LEVEL / DRY CIRCUIT	0.4 VA MAX. @ 20 V AC OR DC MAX.
K		TIN-LEAD ⁶		
Q (STD.)	SILVER ^{4,5}	SILVER ⁵	POWER	TX01 MODELS: 3 AMPS @ 120 V AC OR 28 V DC. ALL OTHER MODELS: 2 AMPS @ 120 V AC OR 28 V DC.
M		TIN-LEAD ⁶		
G	GOLD OVER SILVER ^{2,3}	GOLD ³	LOW LEVEL / DRY CIRCUIT OR POWER	TX01 MODELS: 0.4 VA MAX @ 20 V AC OR DC MAX. OR 3 AMPS @ 120 V AC OR 28 V DC. ALL OTHER MODELS: 0.4 VA MAX. @ 20 V AC OR DC MAX. OR 2 AMPS @ 120 V AC OR 28 V DC.
L		TIN-LEAD ⁶		

CONTACT MATERIAL / APPLICATION RECOMMENDATIONS – SEE CHART, PAGE L-31.

- ¹ CONTACTS & TERMINALS: Copper alloy, with gold plate over nickel plate.
- ² END CONTACTS: Coin silver, with gold plate over nickel plate.
- ³ CENTER CONTACTS & ALL TERMINALS: Copper alloy, with gold plate over nickel plate.
- ⁴ END CONTACTS: Coin silver, silver plated.
- ⁵ CENTER CONTACT & ALL TERMINALS: Copper alloy, silver plated.
- ⁶ TERMINALS: Copper alloy, with tin-lead alloy over nickel plate.

- All models with all options when ordered with G, L, M or Q contact material.
- B contact material standard with A, AV, V3 & W terminations.
- Q contact material standard with C & Z terminations.

SEAL

E (STD.) EPOXY SEAL

