



RSGD General Purpose Soft Starters

Switch

RSGD Series

Compact 3-Phase Soft Starter Series

RSGD is a user-friendly soft starting solution for 3-phase AC induction motors. Supplied in one of the most compact housings in its category, the RSGD series is suitable for soft starting and soft stopping motors rated up to 22kW/25HP @ 400V.

The RSGD reduces starting current significantly whilst maintaining balanced currents on all motor phases. Ramp-up time, ramp-down time and initial torque may be independently adjusted to suit your application needs. Optional relay outputs are also available for top of ramp and alarm indication to provide useful information on the soft starter status to your control system.

Moreover, additional accessories are also available for an easy interconnection to Carlo Gavazzi's manual motor starters, thus resulting in a complete motor starting solution.



The new generation of soft starters

More soft starters in less panel space

RSGD soft starters are designed in an extremely compact 45mm wide housing and are suitable for 3-phase induction motors up to 45A, providing an easy fit in the electrical panel.

Moreover the IP20 housing with a fully enclosed heatsink results in additional protection to personnel and easier installation.

Less heat dissipation

The RSGD series includes internal bypass relays that are triggered as soon as the motor reaches nominal speed, thus reducing heat dissipation inside the electrical panel.

Improved reliability

The internal algorithm ensures that the relays are only triggered at the right instant to avoid current spikes and torque oscillations on the motor, thereby enhancing the lifetime of your system.

Reduced installation costs

With the built-in power supply on the RSGD series (up to 400VAC), quicker and easier installation is guaranteed since fewer connections are required.

Additionally, since there is no need for an auxiliary power supply (RSGD40 models only), panel costs are reduced and less panel space is required.

Flexibility for your applications

The RSGD40 series is available in two control voltage ranges for start and stop signals (24VAC/DC or 110 - 400VAC) facilitating installation and reducing wiring time. The RSGD60 series requires an external supply and the same unit can work with a wider range of supply voltages (220 - 600VAC) with a control voltage range for start and stop signals of 100 - 240VAC.

Main specifications

Operational voltage	RSGD40: 220-400VAC RSGD60: 220-600VAC
Operational current	12/16/25/32/37/45 AAC
Control voltage	Option "E": 110 - 400VAC (available on RSGD40 models only) Option "F": 24VAC/DC (available on RSGD40 models only) Option "G": 100 - 240VAC (available on RSGD60 models only)
Operating temperature	-25°C to + 60°C
Dimensions	12 - 32 A: 45 x 125 x 106 mm (WxHxD) 37 - 45 A: 45 x 130 x 150 mm (WxHxD)
Mounting	DIN or panel
Ramp-up time	1 - 20s
Ramp-down time	0 - 20s
Optional relay outputs	Alarm: Normally closed, (NC) Bypass: Normally open (NO)
Approvals	CE, cULus (UL508), CCC*

*pending

Selection guide

Operational Voltage (Ue)	Rated Operational Current (Ie)	Supply voltage (Us)	Control voltage (Uc)	Motor power 220V (Pe)	Motor power 400V (Pe)	No relay output	With relay output
220 - 400	12A	Internally supplied	110 - 400VAC 24VAC/DC	3kW/3HP	5.5kW/5HP	RSGD4012E0VD00 RSGD4012F0VD00	RSGD4012E0VD20 RSGD4012F0VD20
	16A		110 - 400VAC 24VAC/DC	4kW/5HP	7.5kW/7.5HP	RSGD4016E0VD00 RSGD4016F0VD00	RSGD4016E0VD20 RSGD4016F0VD20
	25A		110 - 400VAC 24VAC/DC	5.5kW/7.5HP	11kW/10HP	RSGD4025E0VD00 RSGD4025F0VD00	RSGD4025E0VD20 RSGD4025F0VD20
	32A		110 - 400VAC 24VAC/DC	9kW/10HP	15kW/15HP	RSGD4032E0VD00 RSGD4032F0VD00	RSGD4032E0VD20 RSGD4032F0VD20
	37A		110 - 400VAC 24VAC/DC	9kW/10HP	18.5kW/20HP	RSGD4037E0VX00 RSGD4037F0VX00	RSGD4037E0VX20 RSGD4037F0VX20
	45A		110 - 400VAC 24VAC/DC	11kW/15HP	22kW/25HP	RSGD4045E0VX00 RSGD4045F0VX00	RSGD4045E0VX20 RSGD4045F0VX20
220 - 600	12A	100 - 240 VAC	100 - 240 VAC	3kW/3HP	5.5kW/5HP	9kW/10HP	RSGD6012GGVD20
	16A			4kW/5HP	7.5kW/7.5HP	11kW/15HP	RSGD6016GGVD20
	25A			5.5kW/7.5HP	11kW/10HP	20kW/20HP	RSGD6025GGVD20
	32A			9kW/10HP	15kW/15HP	22kW/30HP	RSGD6032GGVD20
	37A			9kW/10HP	18.5kW/20HP	30kW/30HP	RSGD6037GGVX20
	45A			11kW/15HP	22kW/25HP	37kW/40HP	RSGD6045GGVX20

RSGD Series

Compact 3-Phase Soft Starter Series

High starting currents with conventional starting methods

Starting motors via direct on line (contactors) always results in a high inrush current, normally reaching 6 to 8 times the rated motor current.

As of June 2011, new efficiency classes for induction motors have been introduced as part of the European Energy using Products (EuP) Directive.

Motor current

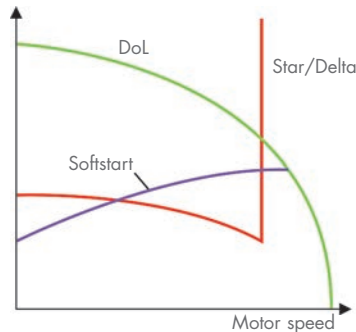

Torque

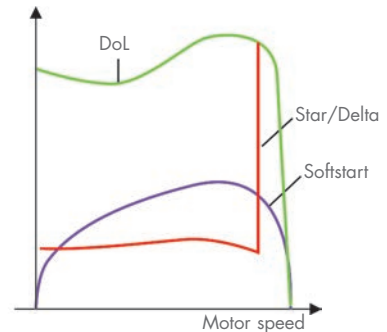

Higher starting currents with higher efficiency motors

Higher efficiency motors (such as IE2, IE3, NEMA Premium) may require even higher currents to start (up to 15 times the rated motor current) causing:

- Disturbance to the supply network
- Tripping of protection equipment
- Water hammering in pump installations

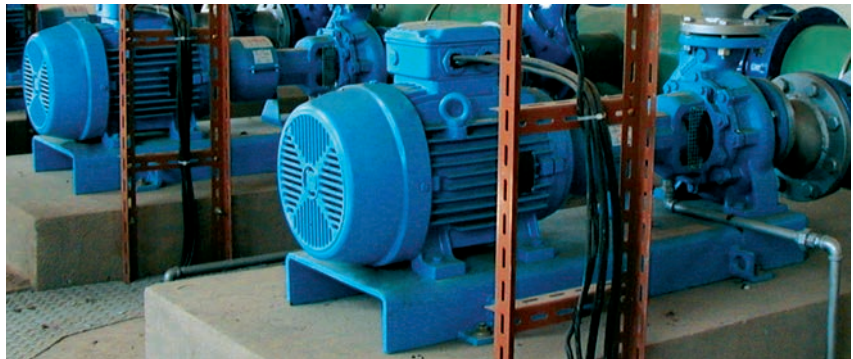

Extending motor lifetime through start current reduction & current balancing strategy

RSGD soft starters are designed to significantly reduce motor starting currents through an advanced control algorithm, thereby reducing mechanical vibrations during starting and electrical disturbances.

All this translates into an increased motor lifetime and reduction in breakdowns.

Moreover, the auto-adaptive algorithm on the RSGD series improves the product's performance at every start by achieving an outstanding balance of the currents on all the motor phases.

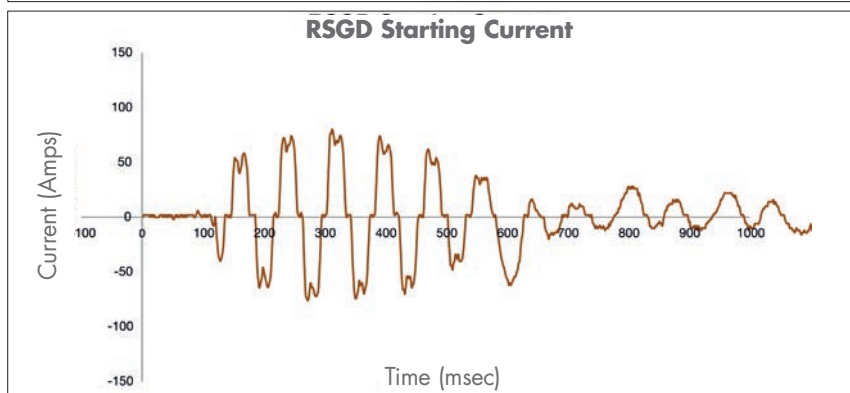
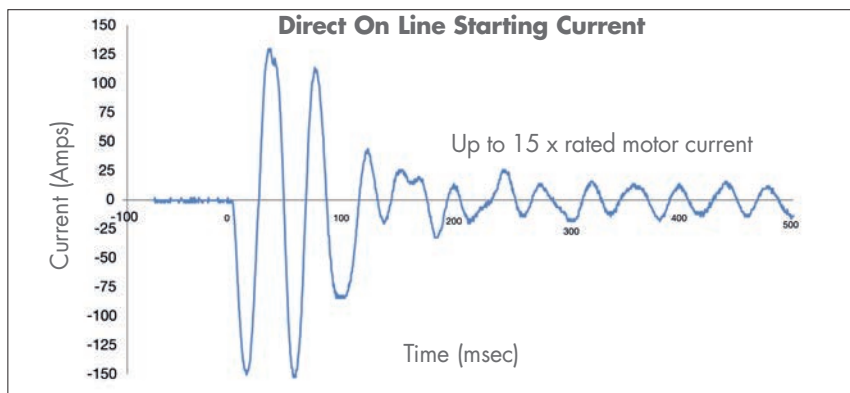

RSGD Soft Starters benefits

- Easy integration in panels through the compact 45mm wide housing
- User friendly installation
- Improved inrush current reduction
- Less current imbalance during start
- Less voltage disturbances
- Less heat dissipation
- Reduced panel costs

Easy configuration

Every single application requires different starting and stopping parameters to achieve optimal starting

and stopping performance. The RSGD can be configured for the particular application requirements through

three independently adjustable knobs for starting voltage, starting and stopping time.

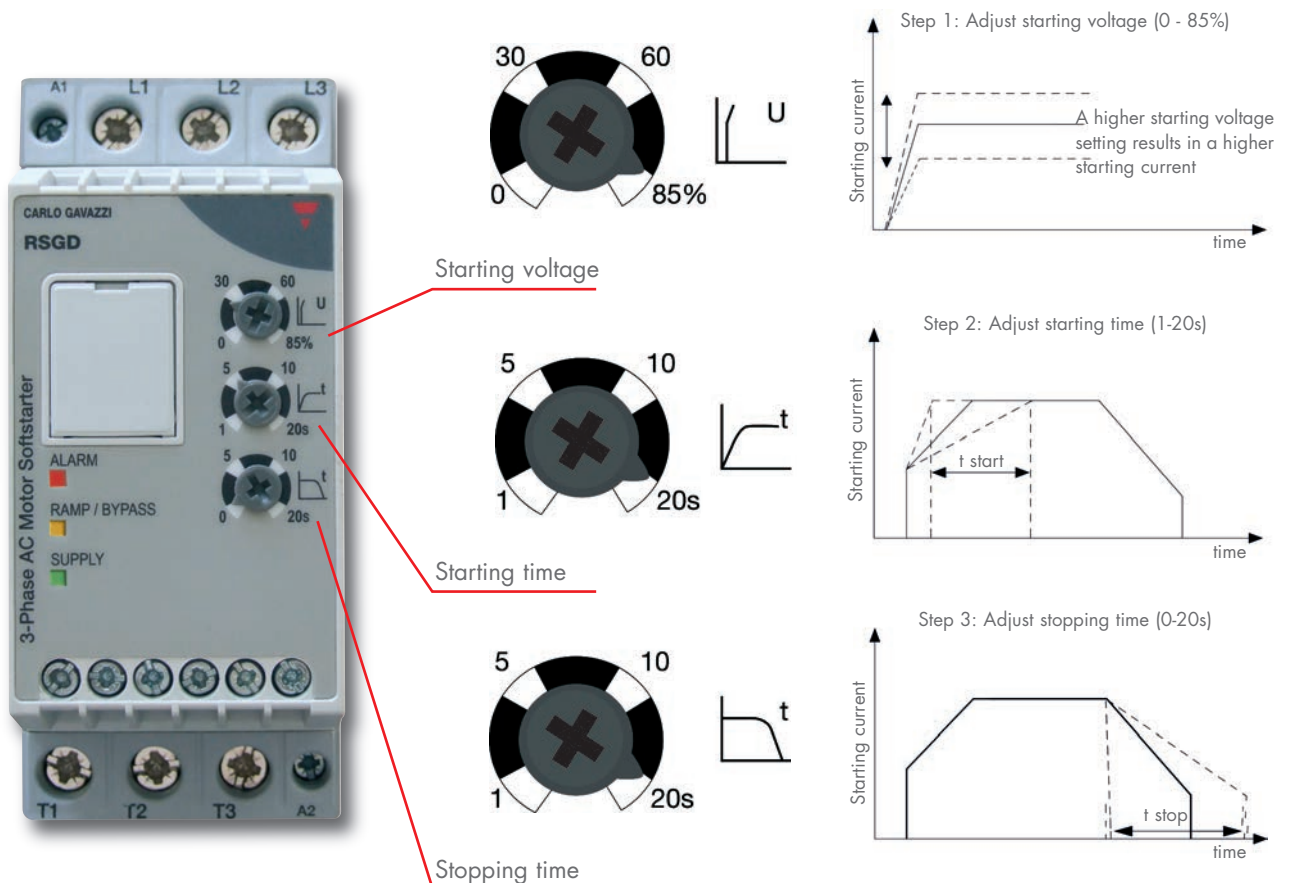

RSGD Series

Compact 3-Phase Soft Starter Series

Expanding operational flexibility through modular design

GMS32S

Short circuit and Overload Protection



GMS32H

Short circuit and Overload Protection



RTPMGMS32SL/RTPMGMS32HL

Interconnecting clip

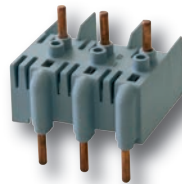

LED indication

For Supply, Alarm and Status

ALARM



RAMP/BYPASS



SUPPLY



Optional relay output

For alarm and Top of ramp indication



Alarm information

on side label

CARLO GAVAZZI

Alarm Indications (Red LED)

No of Flashes	Alarm Condition
2	Wrong Phase Sequence
3	Line Voltage Out of Range
4	Frequency Out of Range
5	Locked Rotor Condition (during Ramp)
6	Ramp Up Time
7	Over Temperature
8	Current Not Normal (at Bypass)
9	Supply Voltage Unbalance

Increased flexibility through auxiliary contacts

Optional relay contacts for alarm and bypass indication, available on the RSGD, ensure that the product meets a wider range of application requirements.

More protection with inbuilt diagnostic

The RSGD series is equipped with a number of diagnostic functions such as:

- Phase sequence monitoring
- Locked rotor protection
- Voltage unbalance
- Under and over voltage detection

These provide additional functionality and protection without the need for additional components in the electrical panel.

Complete motor protection

Short circuit and overload protection is easily achieved through the Carlo Gavazzi GMS manual motor starters which can be connected to the RSGD soft starters without the need for special tools, resulting in a solution that offers greater panel space saving and reduced installation time.

More starts when required

When the application requires a higher number of starts/hr, the RSGD starting capacity can be increased through the use of the easy to install fan available, as an option, on the 37 and 45A units.

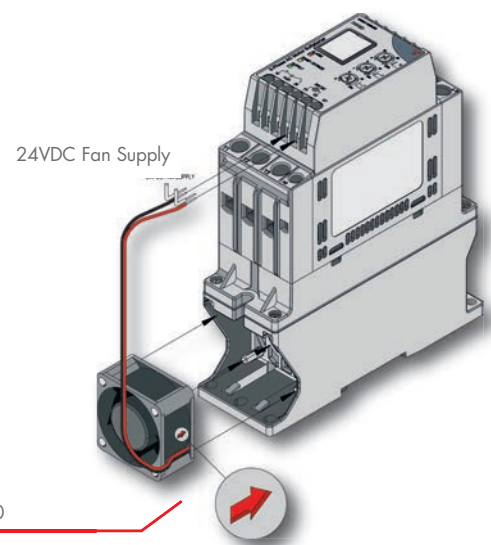

Applications

HVAC

- Piston compressors
- Air compressors
- Centrifugal pumps
- Screw compressor
- Ventilators



Lifts & Escalators

- Hydraulic lifts
- Material handling lifts



Agriculture

- Centrifugal pumps
- Irrigation systems
- Aerators
- Water treatment
- Booster pumps
- Suction pumps
- Distribution pumps



Plastic & Rubber

- Extruding machines
- Grinders
- Mixers
- Blowers
- Dryers

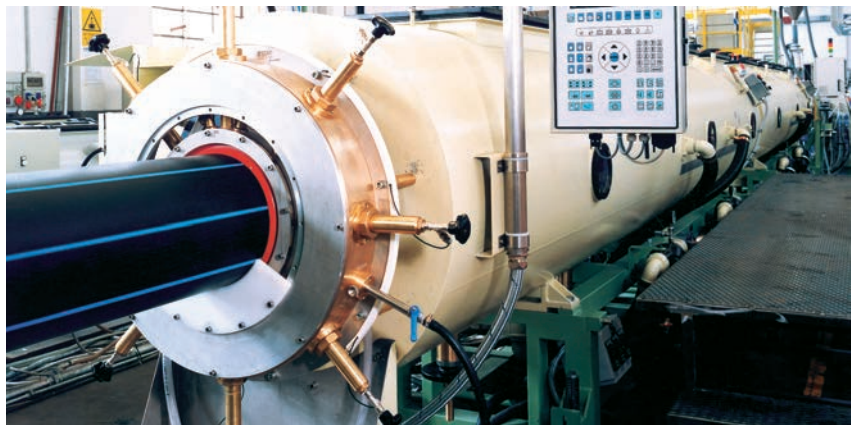

OUR SALES NETWORK IN EUROPE

AUSTRIA - Carlo Gavazzi GmbH
Ketzergerasse 374, A-1230 Wien
Tel: +43 1 888 4112
Fax: +43 1 889 10 53
office@carlogavazzi.at

BELGIUM - Carlo Gavazzi NV/SA
Mechelsesteenweg 311, B-1800 Vilvoorde
Tel: +32 2 257 4120
Fax: +32 2 257 41 25
sales@carlogavazzi.be

DENMARK - Carlo Gavazzi Handel A/S
Over Hadstenvej 40, DK-8370 Hadsten
Tel: +45 89 60 6100
Fax: +45 86 98 15 30
handel@gavazzi.dk

FINLAND - Carlo Gavazzi OY AB
Petaksentie 2-4, FI-00661 Helsinki
Tel: +358 9 756 2000
Fax: +358 9 756 20010
myynti@gavazzi.fi

FRANCE - Carlo Gavazzi Sarl
Zac de Paris Nord II, 69, rue de la Belle
Etoile, F-95956 Roissy CDG Cedex
Tel: +33 1 49 38 98 60
Fax: +33 1 48 63 27 43
french.team@carlogavazzi.fr

GERMANY - Carlo Gavazzi GmbH
Pfnorstr. 10-14
D-64293 Darmstadt
Tel: +49 6151 81000
Fax: +49 6151 81 00 40
info@gavazzi.de

GREAT BRITAIN - Carlo Gavazzi UK Ltd
7 Springlakes Industrial Estate,
Deadbrook Lane, Hants GU12 4UH,
GB-Aldershot
Tel: +44 1 252 339600
Fax: +44 1 252 326 799
sales@carlogavazzi.co.uk

ITALY - Carlo Gavazzi SpA
Via Milano 13, I-20020 Lainate
Tel: +39 02 931 761
Fax: +39 02 931 763 01
info@gavazziacbu.it

NETHERLANDS - Carlo Gavazzi BV
Wijkemeerweg 23,
NL-1948 NT Beverwijk
Tel: +31 251 22 9345
Fax: +31 251 22 60 55
info@carlogavazzi.nl

NORWAY - Carlo Gavazzi AS
Melkeveien 13, N-3919 Porsgrunn
Tel: +47 35 93 0800
Fax: +47 35 93 08 01
post@gavazzi.no

PORTUGAL - Carlo Gavazzi Lda
Rua dos Jerónimos 38-B,
P-1400-212 Lisboa
Tel: +351 21 361 7060
Fax: +351 21 362 13 73
carlogavazzi@carlogavazzi.pt

SPAIN - Carlo Gavazzi SA
Avda. Iparraguirre, 80-82,
E-48940 Leioa (Bizkaia)
Tel: +34 94 480 4037
Fax: +34 94 480 10 61
gavazzi@gavazzi.es

SWEDEN - Carlo Gavazzi AB
V:a Kyrkogatan 1,
S-652 24 Karlstad
Tel: +46 54 85 1125
Fax: +46 54 85 11 77
info@carlogavazzi.se

SWITZERLAND - Carlo Gavazzi AG
Verkauf Schweiz/Vente Suisse
Sumpfstrasse 6312,
CH-632 Steinhausen
Tel: +41 41 747 4535
Fax: +41 41 740 45 40
info@carlogavazzi.ch

OUR SALES NETWORK IN NORTH AMERICA

USA - Carlo Gavazzi Inc.
750 Hastings Lane,
USA-Buffalo Grove, IL 60089,
Tel: +1 847 465 6100
Fax: +1 847 465 7373
sales@carlogavazzi.com

CANADA - Carlo Gavazzi Inc.
2660 Meadowvale Boulevard,
CDN-Mississauga Ontario L5N 6M6,
Tel: +1 905 542 0979
Fax: +1 905 542 22 48
gavazzi@carlogavazzi.com

MEXICO - Carlo Gavazzi Mexico S.A. de
C.V.
Calle La Montaña no. 28, Fracc. Los
Pastores
Naucalpan de Juárez, EDOMEX CP 53340
Tel & Fax: +52.55.5373.7042
mexicosales@carlogavazzi.com

BRAZIL - Carlo Gavazzi Automação
Ltda. Avenida Brig. Luis Antônio, 3067
B. J. Paulista CEP 01401-000 São Paulo
Tel: +55 11 3052 0832
Fax: +55 11 3057 1753
info@carlogavazzi.com.br

OUR SALES NETWORK IN ASIA AND PACIFIC

SINGAPORE - Carlo Gavazzi Automation
Singapore Pte. Ltd.
61 Tai Seng Avenue
#05-06 UE Print Media Hub
Singapore 534167
Tel: +65 67 466 990
Fax: +65 67 461 980

MALAYSIA - Carlo Gavazzi Automation
(M) SDN. BHD.
D12-06-G, Block D12,
Pusat Perdagangan Dana 1,
Jalan PJU 1A/46, 47301 Petaling Jaya,
Selangor, Malaysia.
Tel: +60 3 7842 7299
Fax: +60 3 7842 7399

CHINA - Carlo Gavazzi Automation
(China) Co. Ltd.
Unit 2308, 23/F.,
News Building, Block 1, 1002
Middle Shennan Zhong Road,
Shenzhen, China
Tel: +86 755 83699500
Fax: +86 755 83699300

HONG KONG - Carlo Gavazzi
Automation Hong Kong Ltd.
Unit 3 12/F Crown Industrial Bldg.,
106 How Ming St., Kwun Tong,
Kowloon, Hong Kong
Tel: +852 23041228
Fax: +852 23443689

OUR COMPETENCE CENTRES AND PRODUCTION SITES

Carlo Gavazzi Industri A/S
Hadsten - **DENMARK**

Carlo Gavazzi Ltd
Zejtun - **MALTA**

Carlo Gavazzi Controls SpA
Belluno - **ITALY**

Uab Carlo Gavazzi Industri Kaunas
Kaunas - **LITHUANIA**

Carlo Gavazzi Automation
(Kunshan) Co., Ltd.
Kunshan - **CHINA**

HEADQUARTERS

Carlo Gavazzi Automation SpA
Via Milano, 13 - I-20020
Lainate (MI) - **ITALY**
Tel: +39 02 931 761
info@gavazziautomation.com



CARLO GAVAZZI
Automation Components

Energy to Components!

www.gavazziautomation.com

