

KEMET Part Number: SSRH7H-M06237
(UALSH7M0623700)

KEMET, SSRH7H-M, AC Line Filters, Common Mode, 0.0237 H

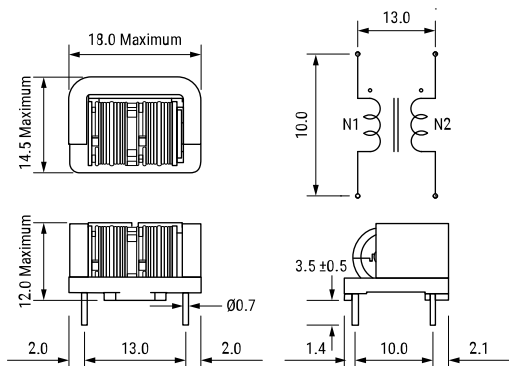

Dimensions

L	18mm MAX
T	14.5mm MAX
H	12mm MAX
LL	3.5mm +/-0.5mm
S	13mm NOM

Packaging Specifications

Packaging:	Tray
Packaging Quantity:	600
Weight:	5.2 g

General Information

Series:	SSRH7H-M
Style:	Through-Hole
RoHS:	Yes
Notes:	M06 Lot No.
Miscellaneous:	Temperature Rise Maximum: 55 K

Specifications

Voltage AC:	250 VAC
Inductance:	23.7 mH (10 kHz)
Current:	600 mA
Temperature Range:	-25/+120°C
DC Resistance:	780 mOhms