

Your Global Automation Partner

TURCK

TBEN-LL-8IOL

IO-Link Master Module

Instructions for Use



Table of Contents

1	About These Instructions	7
1.1	Target groups.....	7
1.2	Explanation of symbols used	7
1.3	Additional documents.....	7
1.4	Feedback about these instructions.....	7
2	Notes on the Product	8
2.1	Product identification.....	8
2.2	Scope of delivery	8
2.3	Legal requirements	8
2.4	Manufacturer and service	8
3	For Your Safety	9
3.1	Intended use.....	9
3.2	General safety notes	9
4	System Description IO-Link	10
4.1	Features.....	10
4.2	System architecture	11
4.3	Operating principle.....	12
4.4	Operating modes.....	12
4.4.1	IO-Link mode	12
4.4.2	Standard I/O mode (SIO mode)	14
5	Product Description	15
5.1	Device overview	15
5.1.1	Block diagram.....	16
5.2	Properties and features.....	16
5.3	Operating principle.....	17
5.4	Functions and operating modes	17
5.4.1	Multiprotocol technology.....	17
5.4.2	IO-Link channels.....	17
5.4.3	Configurable digital channels – functions.....	18
6	Mounting	19
6.1	Mounting the device outdoors	19
6.2	Grounding the device.....	20
6.2.1	Equivalent wiring diagram and shielding concept	20
6.2.2	Shielding of the fieldbus and I/O level.....	20
6.2.3	Grounding the device – I/O level and fieldbus level	21
7	Connecting	23
7.1	Connecting the device to Ethernet.....	23
7.2	Connecting the power supply	24
7.2.1	Supply concept.....	25
7.3	Connecting IO-Link devices and digital sensors	26
8	Commissioning	28
8.1	Setting the IP address.....	28
8.1.1	Setting the IP address via switches at the device.....	28
8.1.2	Setting the IP address with Turck Service Tool	30

8.1.3	Setting the IP address via the web server	32
8.2	ARGEE/FLC	33
8.3	Commissioning an IO-Link device with IO-Link V1.0.....	33
8.4	Commissioning an IO-Link device with IO-Link V1.1.....	34
8.5	Read in connected IO-Link devices: topology scan in the DTM	36
8.6	Commissioning the device in PROFINET.....	37
8.6.1	PROFINET IO device model.....	37
8.6.2	Device model – TBEN-L...-8IOL	38
8.6.3	Address setting in PROFINET	39
8.6.4	FSU – Fast Start-Up (prioritized startup).....	39
8.6.5	MRP (Media Redundancy Protocol).....	39
8.6.6	User data for acyclic services	40
8.6.7	The IO-Link function block IOL_CALL.....	44
8.7	Connecting the device to a Siemens PLC in PROFINET	48
8.7.1	Installing the GSDML file	49
8.7.2	Connecting the devices to the PLC	50
8.7.3	Assigning the PROFINET device name	51
8.7.4	Setting the IP address in TIA Portal	52
8.7.5	Configuring device functions.....	53
8.7.6	Going online with the PLC.....	56
8.7.7	PROFINET – mapping	56
8.7.8	Use the IO_LINK_DEVICE function block in TIA Portal.....	57
8.8	Commissioning the device in Modbus TCP.....	64
8.8.1	Implemented Modbus functions	64
8.8.2	Modbus registers	64
8.8.3	Data width	67
8.8.4	Register mapping.....	68
8.8.5	Error Behavior (watchdog).....	70
8.9	Commissioning the Device in EtherNet/IP	70
8.9.1	Common EtherNet/IP features.....	70
8.9.2	EDS files and catalog files.....	70
8.9.3	Device Level Ring (DLR)	71
8.9.4	Diagnostic messages via process data	71
8.9.5	EtherNet/IP standard classes	72
8.9.6	VSC-Vendor Specific Classes	92
8.10	Connecting the Devices to a Rockwell PLC with EtherNet/IP	106
8.10.1	Adding the devices from the catalog files to the new project	107
8.10.2	Configuring the device in RS Logix	109
8.10.3	Parameterizing the device.....	110
8.10.4	Going online with the PLC.....	111
8.10.5	Reading process data	113
9	Parameterizing and Configuring	114
9.1	Parameters.....	114
9.1.1	Adapting process data mapping.....	120
9.1.2	PROFINET parameters	121
9.2	IO-Link functions for acyclic communication	121
9.2.1	Port functions for Port 0 (IO-Link Master).....	122
10	Operating	127
10.1	Process input data.....	127
10.2	Process output data	129
10.3	LED displays.....	130

10.4	Software diagnostic messages	131
10.4.1	Status- and control word.....	132
10.4.2	Diagnostic telegram.....	133
10.4.3	PROFINET diagnostics	135
10.5	Using the data storage mode.....	137
10.5.1	Parameter "data storage mode" = activated	137
10.5.2	Parameter "data storage mode" = read in	139
10.5.3	Parameter "data storage mode" = overwrite.....	139
10.5.4	Parameter "data storage mode" = deactivated, clear.....	139
11	Troubleshooting	140
11.1	Eliminate parameterization errors.....	140
12	Maintenance	141
12.1	Carry out firmware update via FDT/DTM.....	141
13	Repair	144
13.1	Returning devices.....	144
14	Disposal	144
15	Technical data	145

1 About These Instructions

These operating instructions describe the structure, functions and the use of the product and will help you to operate the product as intended. Read these instructions carefully before using the product. This is to avoid possible damage to persons, property or the device. Retain the instructions for future use during the service life of the product. If the product is passed on, pass on these instructions as well.

1.1 Target groups

These instructions are aimed at qualified personal and must be carefully read by anyone mounting, commissioning, operating, maintaining, dismantling or disposing of the device.

1.2 Explanation of symbols used

The following symbols are used in these instructions:



DANGER

DANGER indicates a dangerous situation with high risk of death or severe injury if not avoided.



WARNING

WARNING indicates a dangerous situation with medium risk of death or severe injury if not avoided.



CAUTION

CAUTION indicates a dangerous situation of medium risk which may result in minor or moderate injury if not avoided.



NOTICE

NOTICE indicates a situation which may lead to property damage if not avoided.



NOTE

NOTE indicates tips, recommendations and useful information on specific actions and facts. The notes simplify your work and help you to avoid additional work.



CALL TO ACTION

This symbol denotes actions that the user must carry out.



RESULTS OF ACTION

This symbol denotes relevant results of actions.

1.3 Additional documents

The following additional documents are available online at www.turck.com:

- Data sheet
- EU Declaration of Conformity
- Commissioning manual IO-Link devices

1.4 Feedback about these instructions

We make every effort to ensure that these instructions are as informative and as clear as possible. If you have any suggestions for improving the design or if some information is missing in the document, please send your suggestions to techdoc@turck.com.

2 Notes on the Product

2.1 Product identification

These instructions apply for the following IO-Link master module:

- TBEN-LL-8IOL

2.2 Scope of delivery

The scope of delivery includes:

- TBEN-LL-8IOL
- Closure caps for M12 female connectors
- Label clips

2.3 Legal requirements

The device falls under the following EU directives:

- 2014/30/EU (electromagnetic compatibility)
- 2011/65/EU (RoHS Directive)

2.4 Manufacturer and service

Hans Turck GmbH & Co. KG
Witzlebenstraße 7
45472 Mülheim an der Ruhr
Germany

Turck supports you with your projects, from initial analysis to the commissioning of your application. The Turck product database contains software tools for programming, configuration or commissioning, data sheets and CAD files in numerous export formats. You can access the product database at the following address: www.turck.de/products

For further inquiries in Germany contact the Sales and Service Team on:

- Sales: +49 208 4952-380
- Technology: +49 208 4952-390

Outside Germany, please contact your local Turck representative.

3 For Your Safety

The product is designed according to state-of-the-art technology. However, residual risks still exist. Observe the following warnings and safety notices to prevent damage to persons and property. Turck accepts no liability for damage caused by failure to observe these warning and safety notices.

3.1 Intended use

These devices are designed solely for use in industrial areas.

The multiprotocol I/O module TBEN-LL-8IOL is an IO-Link master according to IO-Link specification V1.1 and can be operated in the three Ethernet protocols PROFINET, Ethernet/IP and Modbus TCP. The module detects the bus protocol automatically during the start-up.

The IO-Link master module TBEN-LL-8IOL has eight IO-Link channels. Up to eight IO-Link sensors or IO hubs with IO-Link can be connected to the M12 sockets. In addition, up to 12 digital sensors can be connected directly to it. When using I/O hubs, it is possible to connect up to 128 digital sensors per device.

The devices may only be used as described in these instructions. Any other use is not in accordance with the intended use. Turck accepts no liability for any resulting damage.

3.2 General safety notes

- The device may only be assembled, installed, operated, parameterized and maintained by professionally-trained personnel.
- The device may only be used in accordance with applicable national and international regulations, standards and laws.
- The device only meets the EMC requirements for industrial areas and is not suitable for use in residential areas.
- Change the default password of the integrated web server after the first login. Turck recommends using a secure password.

4 System Description IO-Link

IO-Link is a fieldbus independent communication interface for sensors and actuators. Signals and energy can be exchanged between any networks, fieldbuses and backplane buses via a digital, serial point-to-point connection.

Each IO-Link system consists of an IO-Link master and an IO-Link device (e.g. sensor, I/O hub, valve block). An IO-Link master is provided with at least one IO-Link port (channel). One IO-Link device can be connected to each port. The system components are interconnected according to the port specification via unshielded 3-wire or 5-wire standard cables.

The IO-Link technology is described in the "IO-Link Interface and System Specification" and IEC 61131-9. IO-Link capable devices comply either with specification V1.0 or specification V1.1.

The properties, functions and parameters of the IO-Link device are represented in an electronic device description (IODD). The IODDs for Turck devices can be downloaded via the Turck Software Manager and can also be obtained free of charge from www.turck.com. The IODDs of all devices have the same structure and contain the following information for system integration

- Communication properties
- Device parameters with value range and default value
- Identification, process and diagnostic data
- Device data
- Text description
- Picture of the device
- Logo of the manufacturer

The structure of the IODD is defined by the IO-Link specification and is the same for all IO-Link devices. The IODD is based on indexes. The communication properties, device parameters, identification, process, diagnostic and device data are assigned to fixed indexes in the IODD, via which the parameters can be controlled. Some indexes are further divided by sub indexes.

4.1 Features

- Point-to-point connection (max. cable length: 20 m)
- Unshielded 3-wire or 5-wire standard cables
- Cyclical process data transmission
- Acyclical data transmission, e.g. device data and events
- Communication between IO-Link master and IO-Link device possible in three transmission rates
- Parallel exchange of device data without influencing the process data
- Communication via 24 V pulse modulation, standard UART protocol

4.2 System architecture

At least one IO-Link master and one IO-Link device (e.g. sensor or actuator) are required for IO-Link communication. IO-Link master and IO-Link device are interconnected via an unshielded 3-wire or 5-wire standard cable. The setting can be carried out with a configuration tool or via the fieldbus level.

The IO-Link master establishes the connection between IO-Link device and the higher-level control system. An IO-Link master can have several IO-Link ports. Only one IO-Link device can be connected to each port.

IO-Link hubs also make it possible to integrate devices without an IO-Link output in automation systems via IO-Link.

Standard tools and functions are provided for the integration, commissioning and configuration of the IO-Link communication.

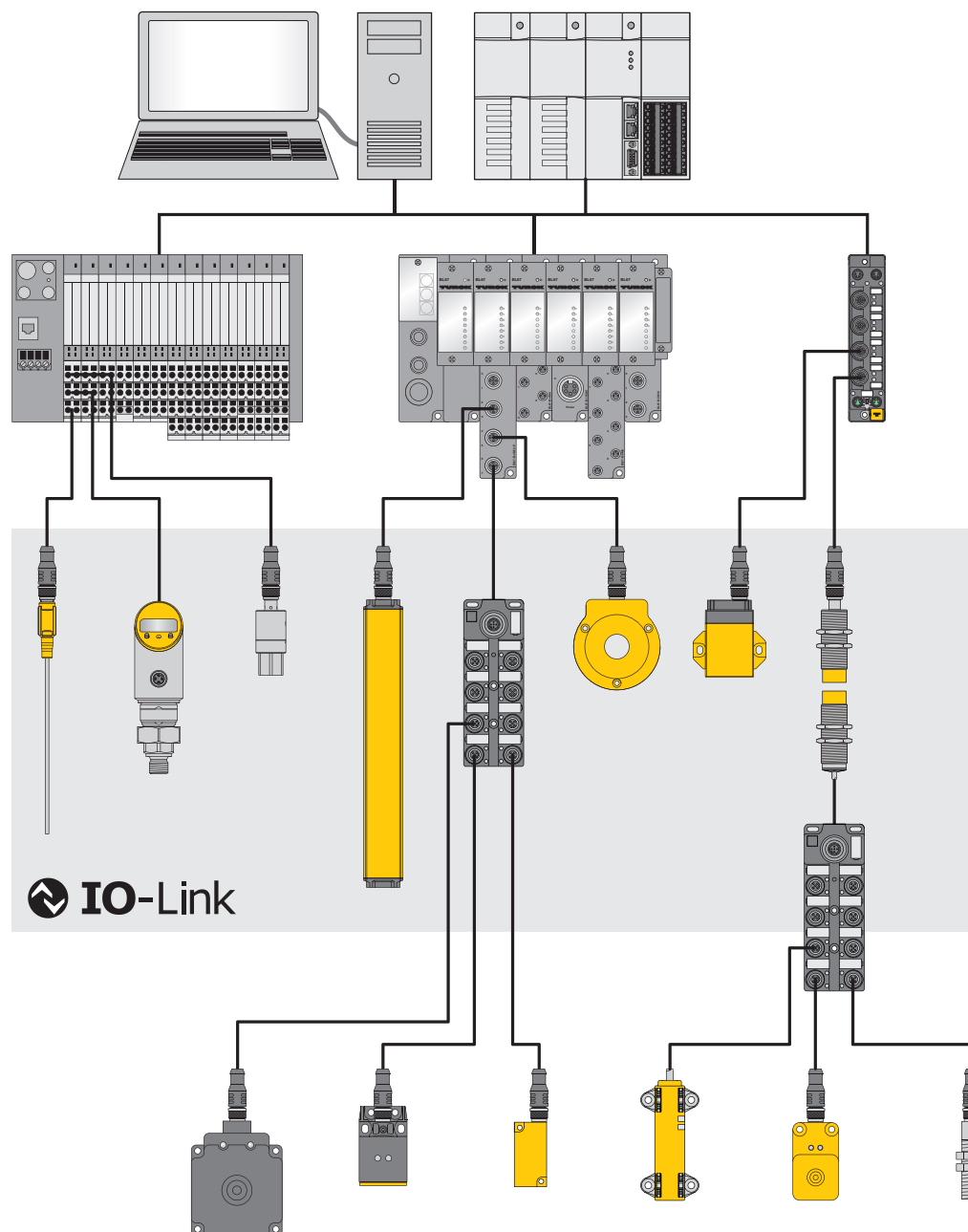

Fig. 1: IO-Link system overview

4.3 Operating principle

IO-Link is a digital point-to-point connection between an IO-Link master and an IO-Link device. Process data and other information such as parameters and diagnostic messages are transferred with a 24 V pulse modulation via a combined switching status and data channel (C/Q).

IO-Link communication is independent of the fieldbus used.

4.4 Operating modes

The operating mode can be set separately at any port of the IO-Link master.

Two operating modes are available for the IO-Link master:

- IO-Link mode: IO-Link communication possible
- Standard I/O mode (SIO): digital I/O communication

IO-Link communication is implemented via the switching and communication cable (C/Q).

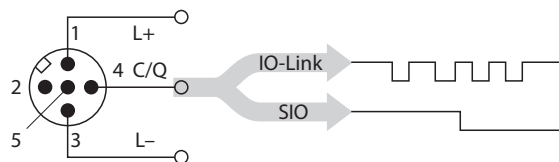

Fig. 2: IO-Link communication via C/Q

During initialization the ports of the IO-Link master behave like a normal digital input. The IO-Link devices are operated in IO-Link mode. A command of the higher-level IO-Link master establishes IO-Link communication in IO-Link mode. This command is called the “Wake-up request”.

4.4.1 IO-Link mode

In IO-Link mode communication takes place between an IO-Link master and an IO-Link device. Communication always starts from the IO-Link master.

Transmission speed between IO-Link master and IO-Link device

Three transmission rates are defined in the IO-Link specification:

- 4,8 kBaud
- 38,4 kBaud
- 230,4 kBaud

Each device supports only one transmission rate, an IO-Link master supports all transmission rates. The transfer time of the cyclical process data is determined by the telegram length as well as the delay times in the device and the master. With a transmission rate of 38.4 kBaud and a telegram length of 2 byte the transmission time is typically 2.3 ms.

Response times

The response time of the IO-Link system provides information on the frequency and speed of the data transmission between IO-Link master and IO-Link device. This response time depends on the following factors:

- Minimum cycle time: Intervals defined in the IODD in which the IO-Link master addresses the IO-Link device. Different minimum cycle times can be defined for different devices.
- Internal processing time of the IO-Link master and the IO-Link device

Cyclical and Acyclical Communication

The data exchanged between IO-Link master and the IO-Link device can be divided into cyclical process data and acyclical data. Process data and value states are transferred cyclically. Acyclical data is transferred separately to cyclic process data. Acyclical data includes device data, parameter functions and events such as diagnostic information, which is only transferred on request. The two communication types are independent of each other and do not interact.

Cyclical communication	
Process data	Value status (port qualifier)
<ul style="list-style-type: none"> ■ 0...32 bytes of process data possible per device (each input and output) ■ Process data size determined by the device 	<ul style="list-style-type: none"> ■ The Port Qualifier indicates whether the process data is valid or not.
Acyclical communication	
Device data	Value status (port qualifier)
<ul style="list-style-type: none"> ■ Parameters, identification data or diagnostic information ■ Data exchange on request of the IO-Link master ■ Device data can be written to the device or read from the device. 	<ul style="list-style-type: none"> ■ Device indicates event to master: Error messages and warnings ■ Master indicates event to device: e.g. cable break or communication abort

Combining IO-Link devices with different specifications

Only devices of specification V1.0 can be operated on IO-Link masters of specification V1.0. Devices of specification V1.0 and V1.1 can be operated on IO-Link masters of specification V1.1.

	IO-Link device V1.0	IO-Link device V1.1
IO-Link master V1.0	x	-
IO-Link master V1.1	x	x

Data storage mode



NOTE

Data storage mode is only available for devices complying with the IO-Link specification V1.1.

Data storage mode makes it possible to replace IO-Link devices without the need for a reconfiguration.

The IO-Link master or the IO-Link device save the device parameters set in the previous configuration. In data storage mode the parameter data memories of IO-Link master and IO-Link device are synchronized. If data storage mode is activated in the IO-Link master, the master writes the stored device parameters to the new device after a device is replaced. The application can be restarted without having to perform a new configuration.

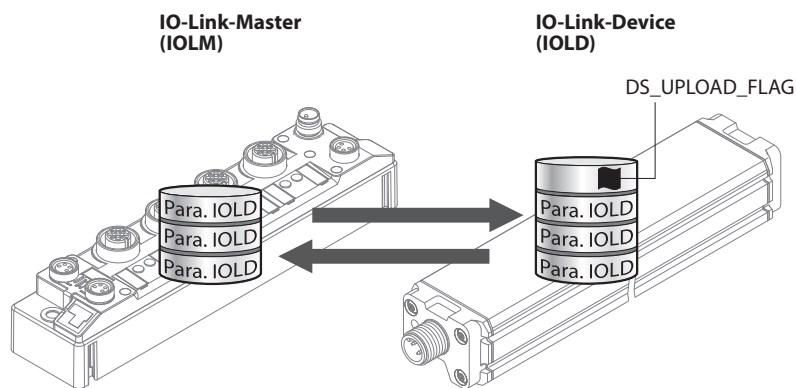

Fig. 3: Data storage mode – general principle, Para. IOLD = parameters of the IO-Link device

4.4.2 Standard I/O mode (SIO mode)

In standard I/O mode IO-Link devices behave like digital sensors or actuators. In this mode the devices only send input or output data to the higher-level instance. IO-Link access to the device is not possible.

5 Product Description

The devices are designed in a fully encapsulated housing with degree of protection IP65/IP67/IP69K.

The IO-Link master module TBEN-LL-8IOL has eight IO-Link ports for connecting IO-Link devices. The IO-Link ports at the connectors X0...X3 are designed as Class A ports. The IO-Link ports at the connectors X4...X7 are designed as Class B ports. In addition to the four IO-Link-channels, four universal digital DXP channels (PNP) are available. The eight IO-Link channels can be parameterized independently of each other and operated either in IO-Link mode or in SIO mode (DI).

With Turck's "Simple IO-Link Device Integration (SIDI)", IO-Link devices can be directly integrated into PROFINET via the GSDML file of the TBEN-LL-8IOL.

The 4 universal digital channels are designed as DXP-channels and can therefore be parameterized as in- or output.

For connecting the supply voltage, the device has 5-pin M12 connectors.

The multiprotocol device can be operated with the three Ethernet protocols PROFINET, Ethernet/IP and Modbus TCP mentioned above by automatic protocol detection without user intervention

5.1 Device overview

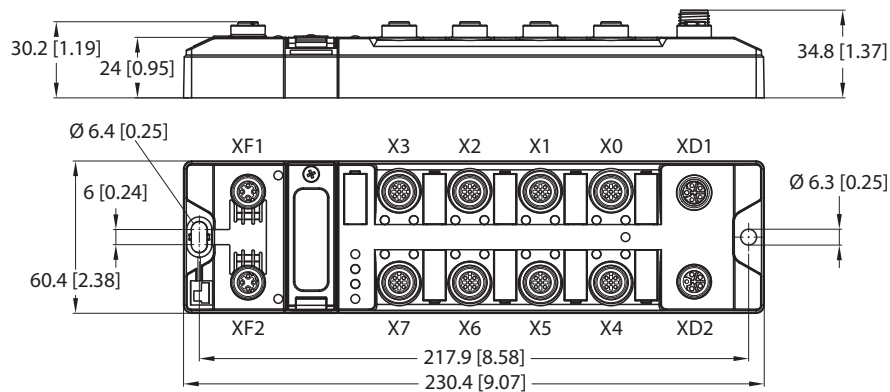

Fig. 4: Dimensions TBEN-LL-8IOL

5.1.1 Block diagram

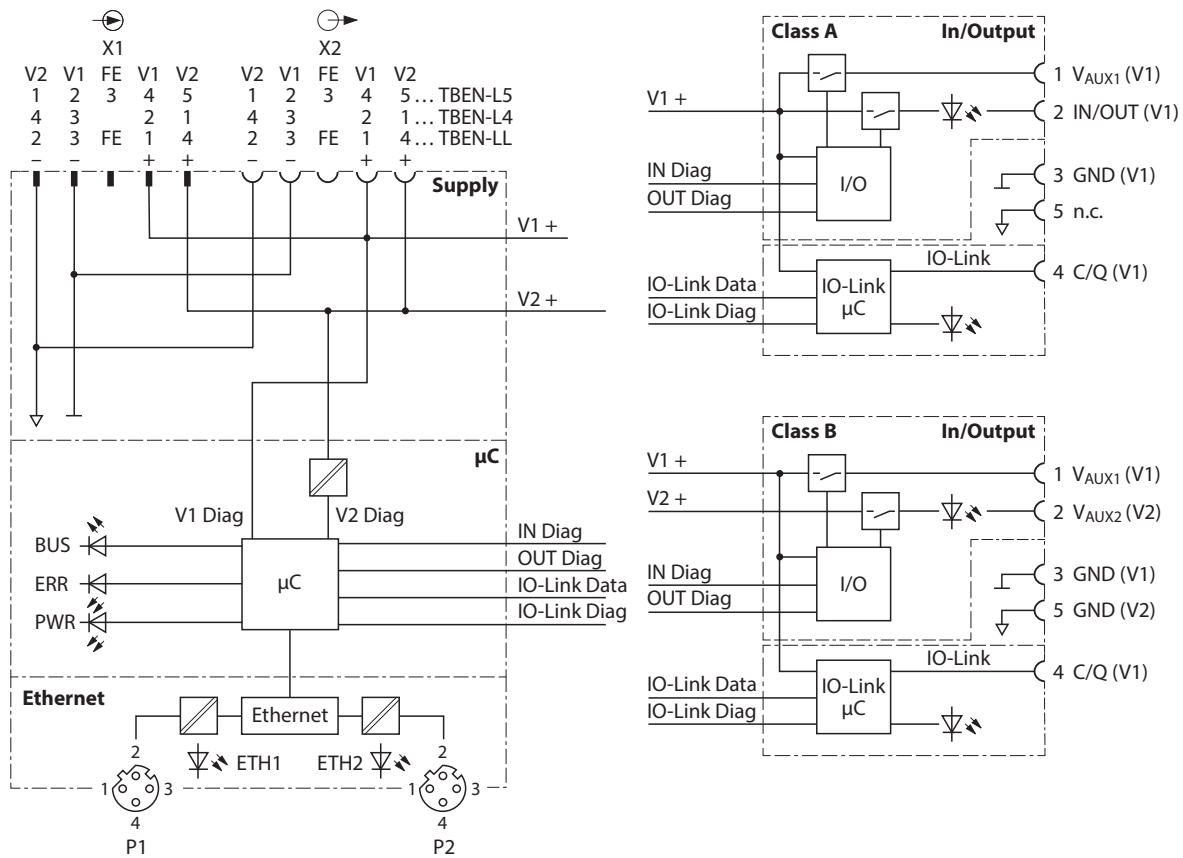

Fig. 5: Block diagram

5.2 Properties and features

- Fibre-glass reinforced housing
- Shock and vibration tested
- Fully potted module electronics
- Degree of protection IP67/IP69K
- UV-resistant according to DIN EN ISO 4892-2
- Metal connectors
- 4 IO-Link ports Class A and 4 IO-Link ports Class B
- Multiprotocol functionality: PROFINET Device, EtherNet/IP Device, Modbus TCP Slave
- 4 universal DXP channels
- PROFINET:
 - Conformance Class B PA
 - Simple IO-Link Device Integration (SIDI)
 - Conformance according to PROFINET specification V2.35
 - System redundancy S2
 - Network load class 3
- EtherNet/IP:
 - Support of the IO-Link Parameter Object for asynchronous services (IO-Link CALL)
 - Predefined in- and output assemblies

5.3 Operating principle

The IO-Link master module TBEN-LL-8IOL connects IO-Link sensors and actuators with the higher-level control system. The device has an Ethernet interface and fieldbus-independent I/O electronics with IO-Link master functionality (Class A and Class B ports). Via the Ethernet interface, the IO-Link master is connected to an (existing) Ethernet network as an EtherNet/IP device, Modbus TCP slave or PROFINET device. During operation, the process data is exchanged between Ethernet and IO-Link. In addition the devices can process signals from sensors and actuators via four configurable digital channels.

5.4 Functions and operating modes

5.4.1 Multiprotocol technology

The devices can be used in the following three Ethernet protocols:

- Modbus TCP
- EtherNet/IP
- PROFINET

The required Ethernet protocol can be detected automatically or determined manually.

Automatic protocol detection

A multi-protocol device can be operated without intervention of the user (which means, without changes in the parameterization) in all of the three Ethernet protocols mentioned.

During the system start-up phase (snooping phase), the module detects which Ethernet protocol requests a connection to be established and adjusts itself to the corresponding protocol. After this an access to the device from other protocols is read-only.

Manual Protocol Selection

The user can also define the protocol manually. In this case, the snooping phase is skipped and the device is fixed to the selected protocol. With the other protocols, the device can only be accessed read-only.

Protocol Dependent Functions

The device Supported the following Ethernet protocol specific functions:

PROFINET

- FSU - Fast Start-Up (prioritized startup)
- Topology discovery
- Address assignment via LLDP
- MRP (Media Redundancy Protocol)

EtherNet/IP

- QC – QuickConnect
- Device Level Ring (DLR)

5.4.2 IO-Link channels

The IO-Link master module TBEN-LL-8IOL has four Class A IO-Link ports (slots X0...X3) and four Class B IO-Link ports (slots X4...X7).

The eight IO-Link channels can be parameterized independently of each other and operated either in IO-Link mode or in SIO mode (DI).

Simple IO-Link Device Integration (SIDI)

Turck's Simple IO-Link Device Integration (SIDI) simplifies the handling of IO-Link devices in PROFINET engineering systems. Since the devices are already integrated in the GSDML file of the master, the user can select the devices from the device library (for example in the TIA portal) and integrate them into his project via drop-down fields as if the devices were submodules of a modular I/O system. The user benefits from plain text access to all device properties and parameters. Measuring ranges, switching points and pulse rates can be set directly from the engineering system - without programming or additional software.

5.4.3 Configurable digital channels – functions

The device is provided with four digital channels, which can be configured as inputs or outputs according to the application requirements. In all, up to four 3-wire PNP sensors or four PNP DC actuators with a maximum output current of 0.5 A can be connected per input or output.

6 Mounting



NOTICE

Mounting on uneven surfaces

Device damage due to stresses in the housing

- ▶ Fix the device on a flat mounting surface.
- ▶ Use two M6 screws for mounting.

The device can be screwed onto a flat mounting plate.

- ▶ Attach the module to the mounting surface with two M6 screws. The maximum tightening torque for the screws is 1.5 Nm.
- ▶ Avoid mechanical stresses.
- ▶ Optional: Ground the device.

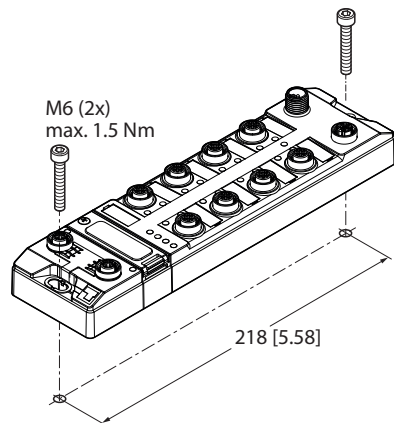

Fig. 6: Mounting the device on a mounting plate

6.1 Mounting the device outdoors

The device is UV-resistant according to DIN EN ISO 4892-2. Direct sunlight can cause material abrasion and color changes. The mechanical and electrical properties of the device are not affected.

- ▶ To avoid material abrasion and color changes: Protect the device from direct sunlight, e.g. by using protective shields.

6.2 Grounding the device

6.2.1 Equivalent wiring diagram and shielding concept

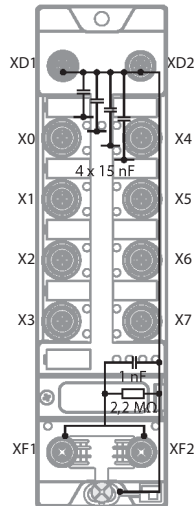

Fig. 7: TBEN-LL-8IOL equivalent circuit diagram and shielding concept

6.2.2 Shielding of the fieldbus and I/O level

The fieldbus and the I/O level of the modules can be grounded separately.

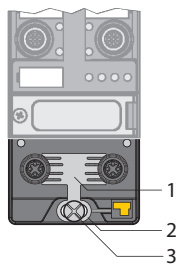

Fig. 8: Grounding clip (1), grounding ring (2) and metal screw (3)

The grounding ring (2) is the module grounding. The shielding of the I/O level is permanently connected to the module grounding. The module grounding is only connected to the reference potential of the installation when the module is mounted.

Shielding concept of the I/O modules (I/O level)

In the case of direct mounting on a mounting plate, the module grounding is connected to the reference potential of the system via the metal screw in the lower mounting hole (3). If module grounding is not desired, the electrical connection to the reference potential must be interrupted, e.g. by using a plastic screw.

Shielding concept of the fieldbus level

On delivery, a grounding clip is provided on the connectors for the fieldbus connection.

When mounted directly on a mounting plate, the shielding of the fieldbus cables is routed directly to the module ground via the grounding clip and the metal screw in the lower mounting hole.

If direct grounding of the fieldbus shield is not desired, the grounding clip must be removed. In this case, the fieldbus shield is connected to the module ground via an RC element.

6.2.3 Grounding the device – I/O level and fieldbus level

The grounding of the fieldbus level can either be connected directly via the grounding clip (1) or connected and routed indirectly via an RC element to the grounding of the I/O level. If the grounding is to be routed via an RC element, the grounding clip must be removed.

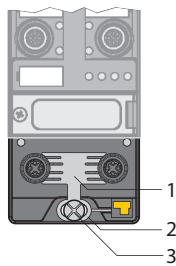

Fig. 9: Grounding clamp (1)

Removing the grounding clip: disconnect the direct grounding of the fieldbus level

- ▶ Use a flat screwdriver to slide the grounding clamp forward and remove it.

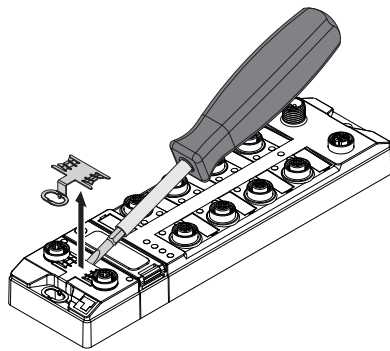

Fig. 10: Removing the grounding clamp

Mounting the grounding clip: grounding the fieldbus level directly

- ▶ Place the grounding clamp between the fieldbus connectors by using a screwdriver in such way that the clamp contacts the metal housing of the connectors.
- ▶ The shielding of the fieldbus cables is connected to the grounding clip.

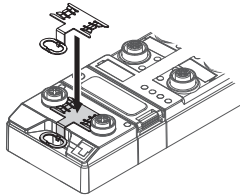

Fig. 11: Mounting the grounding clip

Grounding the device – mounting on a mounting plate

- ▶ For mounting onto a mounting plate: Fix the Device with an M6 metal screw through the lower mounting hole.
- ⇒ The shielding of the M12 flanges for the I/O level is connected to the reference potential of the installation via the M6 metal screw.
- ⇒ With mounted grounding clip: The shielding of the fieldbus is connected to the reference potential of the installation via the module grounding of the I/O level.

7 Connecting

7.1 Connecting the device to Ethernet

For the connection to Ethernet the device has an integrated auto-crossing switch with two 4-pole, D-coded M12 x 1-Ethernet-connectors. The maximum tightening torque is 0.6 Nm.

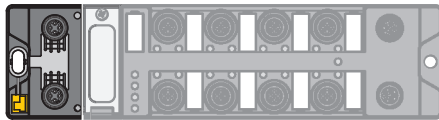

Fig. 12: M12 Ethernet connector

- ▶ Connect the device to Ethernet according to the pin assignment below.

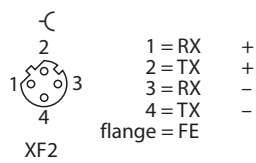
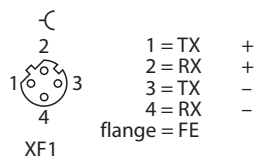

Fig. 13: Pin assignment Ethernet connectors

7.2 Connecting the power supply

For the connection to the power supply, the device has two 5-pin, L coded M12 connectors. V1 and V2 are galvanically isolated from each other. The maximum tightening torque is 0.8 Nm.

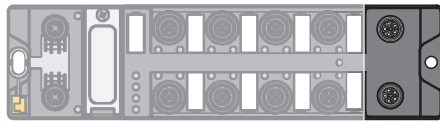

Fig. 14: M12 connector for connecting the supply voltage

- ▶ Connect the device to the power supply according to the pin assignment shown below.

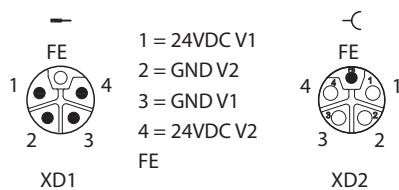

Fig. 15: pin assignment power supply connectors

Connector	Function
XD1	Power feed
XD2	Continuation of the power to the next node
V1	System supply: power supply 1 (incl. supply of electronics)
V2	Load voltage: power supply 2



NOTE

The system voltage (V1) and the load voltage (V2) are fed in and monitored separately. In case of an undercut of the admissible voltage, the connectors are switched-off according to the module's supply concept. In case of an undervoltage at V2, the LED PWR changes from green to red. In case of an undervoltage at V1, the LED PWR is turned off.

7.2.1 Supply concept

The Device is supplied via two separate voltages V1 and V2.

The I/O-channels are therefore consequently separated into the different potential groups "detachable I/O" (supplied through V2) and "non-detachable" I/O (supplied through V1). This allows a safety shutdown of parts of an installation via emergency-off circuits.

V1 = supply of the module electronics and the respective slots

V2 = supply of module electronics and the respective connectors (separately detachable)

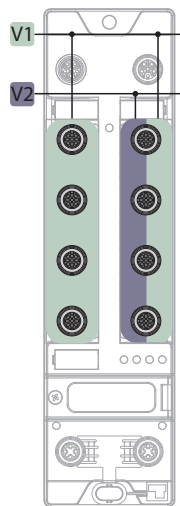

Fig. 16: Power supply of TBEN-LL-8IOL

7.3 Connecting IO-Link devices and digital sensors

The device has eight M12 female connectors for connecting IO-Link devices and digital sensors and actuators. The maximum tightening torque is 0.8 Nm.



NOTICE

Wrong supply of IO-Link devices

Damage to the device electronics

- ▶ Only supply IO-Link devices with the voltage provided at the M12 connectors.

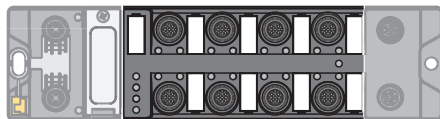

Fig. 17: M12 connectors, IO-Link master ports

- ▶ Connect the sensors and actuators to the device according to the pin assignment.

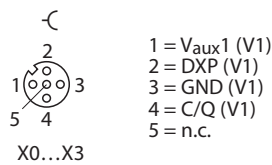

Fig. 18: Pin assignment of IO-Link master ports, Class A, X0...X3

Pin	Meaning
Pin 1	VAUX1, switchable via process data
Pin 2	Digital in- or output (DXP)
Pin 3	Ground (V1)
Pin 4	IO-Link or digital input
Pin 5	Not connected

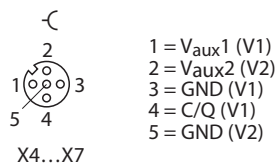

Fig. 19: Pin assignment of IO-Link master ports, Class B, X4...X7

- ▶ Connect the sensors and actuators to the device according to the pin assignment.

Pin	Meaning
Pin 1	VAUX1, switchable via process data
Pin 2	Switchable Class B supply (VAUX2)
Pin 3	Ground V1
Pin 4	IO-Link or digital input
Pin 5	Ground V2



NOTICE

Connection of Class A devices to Class B ports

Loss of the galvanic isolation with Class A devices at pin 2 and 5

- ▶ Only use Class A devices with signals on pin 1, pin 3 and pin 4 at Class B ports.

8 Commissioning

8.1 Setting the IP address

The IP address can be set via three decimal rotary coding switches and DIP switches on the device, via the web server or via the Turck Service Tool.

8.1.1 Setting the IP address via switches at the device

The IP address can be set via three decimal rotary coding switches on the device.

The switches are located under a cover together with the SET button.

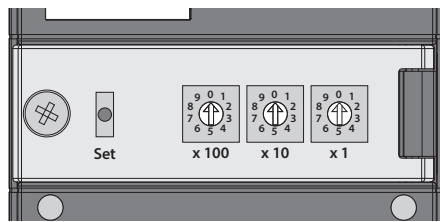

Fig. 20: Switches for setting the IP address

- ▶ Open the cover over the switches.
- ▶ Set the required rotary coding switches to the required position according to the table below.
- ▶ Carry out a voltage reset.
- ▶ **NOTICE!** IP67 or IP69K protection is not guaranteed when the cover over the rotary coding switches is opened. Device damage through penetrating foreign objects or liquids is possible. Close the cover over the switches securely.

Addressing options

The IP address of the devices can be set in different ways. The following addressing options can be selected via the switches on the device. Setting changes are activated after a voltage reset.

Setting option	Rotary coding switch	Description
Default address	000	IP address: 192.168.1.254 Subnet mask: 255.255.255.0 Gateway: 192.168.1.1
Rotary mode	1...254	In Rotary mode, the last byte of the IP address can be set manually on the gateway. The other network settings can be stored retentively in the gateway memory and cannot be changed in Rotary mode. Addresses 1...254 can be set.
BootP mode	300	In BootP mode, the complete IP address is assigned automatically by a BootP server in the network. The subnet mask assigned by the BootP server and the default gateway address are stored retentively in the gateway memory.
DHCP mode	400	In DHCP mode, the complete IP address is assigned automatically by a DHCP server in the network. The subnet mask assigned by the DHCP server and the default gateway address are stored retentively in the gateway memory. DHCP supports three types of IP address assignment: <ul style="list-style-type: none"> ■ Automatic address assignment: The DHCP server assigns a permanent IP address to the client. ■ Dynamic address assignment: The IP address assigned by the server is always only reserved for a specific period. After this time has elapsed or after the explicit release by a client, the IP address is reassigned. ■ Manual address assignment: A network administrator assigns an IP address to the client. DHCP is only used in this case to transfer the assigned IP address to the client.
PGM mode	500	In PGM mode, the complete IP address is assigned manually via the Turck Service tool, FDT/DTM or via a web server. In PGM mode, the set IP address and the subnet mask are stored in the gateway memory. All network settings (IP address, subnet mask, default gateway) are accepted by the internal EEPROM of the module.
PGM-DHCP mode	600	In PGM-DHCP mode, the gateway transmits DHCP requests until it is assigned a fixed IP address. The DHCP client is automatically deactivated if an IP address is assigned to the gateway via the DTM or a web server.
F_Reset	900	F_Reset mode resets all device settings to the default values and clears all data in the internal flash memory of the device. The following values are reset or deleted: <ul style="list-style-type: none"> ■ IP address and subnet mask ■ PROFINET Device Name ■ Parameters

8.1.2 Setting the IP address with Turck Service Tool

- ▶ Connect the device to a PC via the Ethernet interface.
- ▶ Open the Turck Service Tool.
- ▶ Click **Search** or press F5.

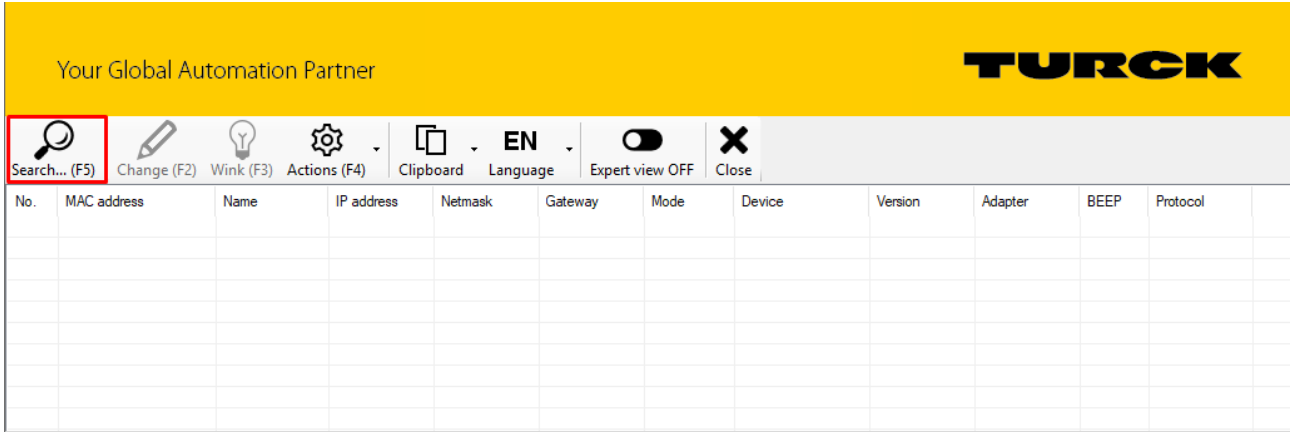

Fig. 21: Turck Service Tool – start dialog

The Turck Service Tool shows the connected devices.

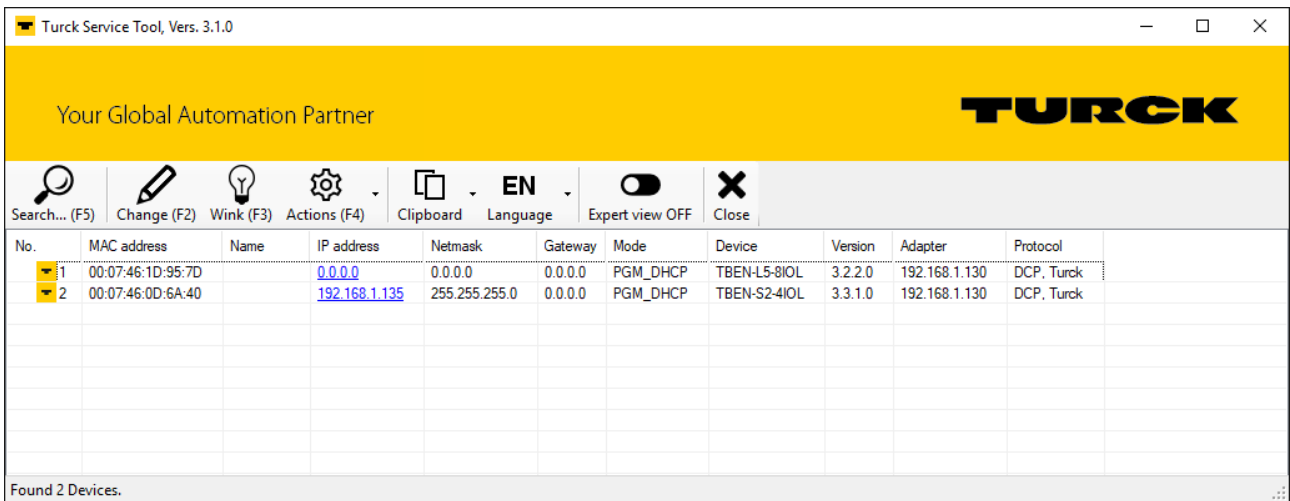

Fig. 22: Turck Service Tool – found devices

- ▶ Click on the desired device.
- ▶ Click **Change** or press [F2].

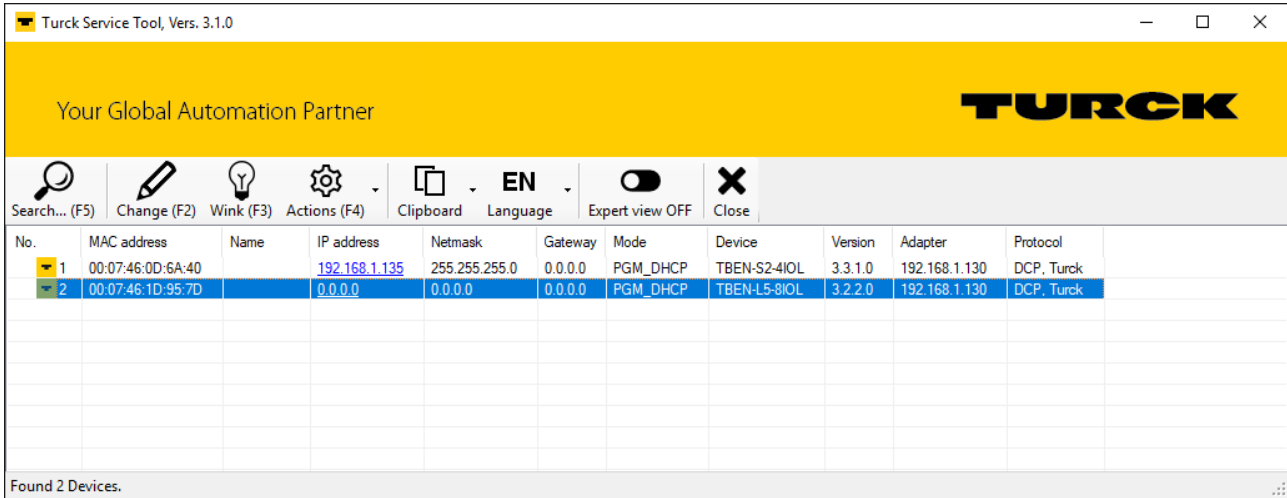

Fig. 23: Turck Service Tool – select the device to be addressed



NOTE

Clicking the IP address of the device opens the web server.

- ▶ Change the IP address and the network mask if necessary.
- ▶ Assume the changes by clicking **Set in device**.

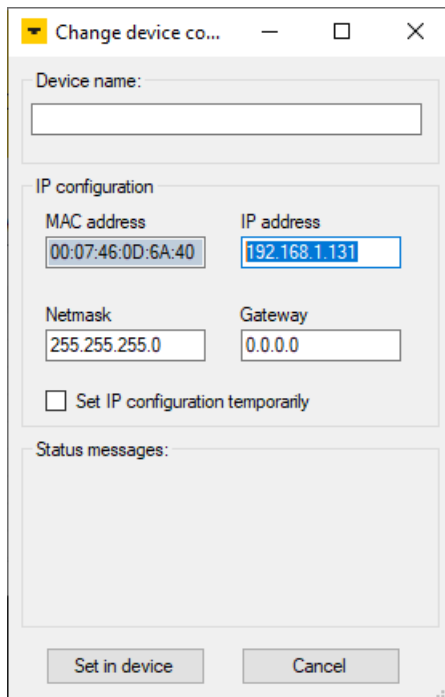

Fig. 24: Turck Service Tool – Change device configuration

8.1.3 Setting the IP address via the web server



NOTE

To set the IP address via the web server, the device must be in PGM mode.

- ▶ Opening the web server
- ▶ Log- in to the web server as administrator. The default password for the web server is "password".
- ▶ Click **Station** → **Network Configuration**.
- ▶ Change the IP address and if necessary also the subnet mask and default gateway.
- ▶ Write the new IP address, subnet mask and default gateway via **Submit** to the device.

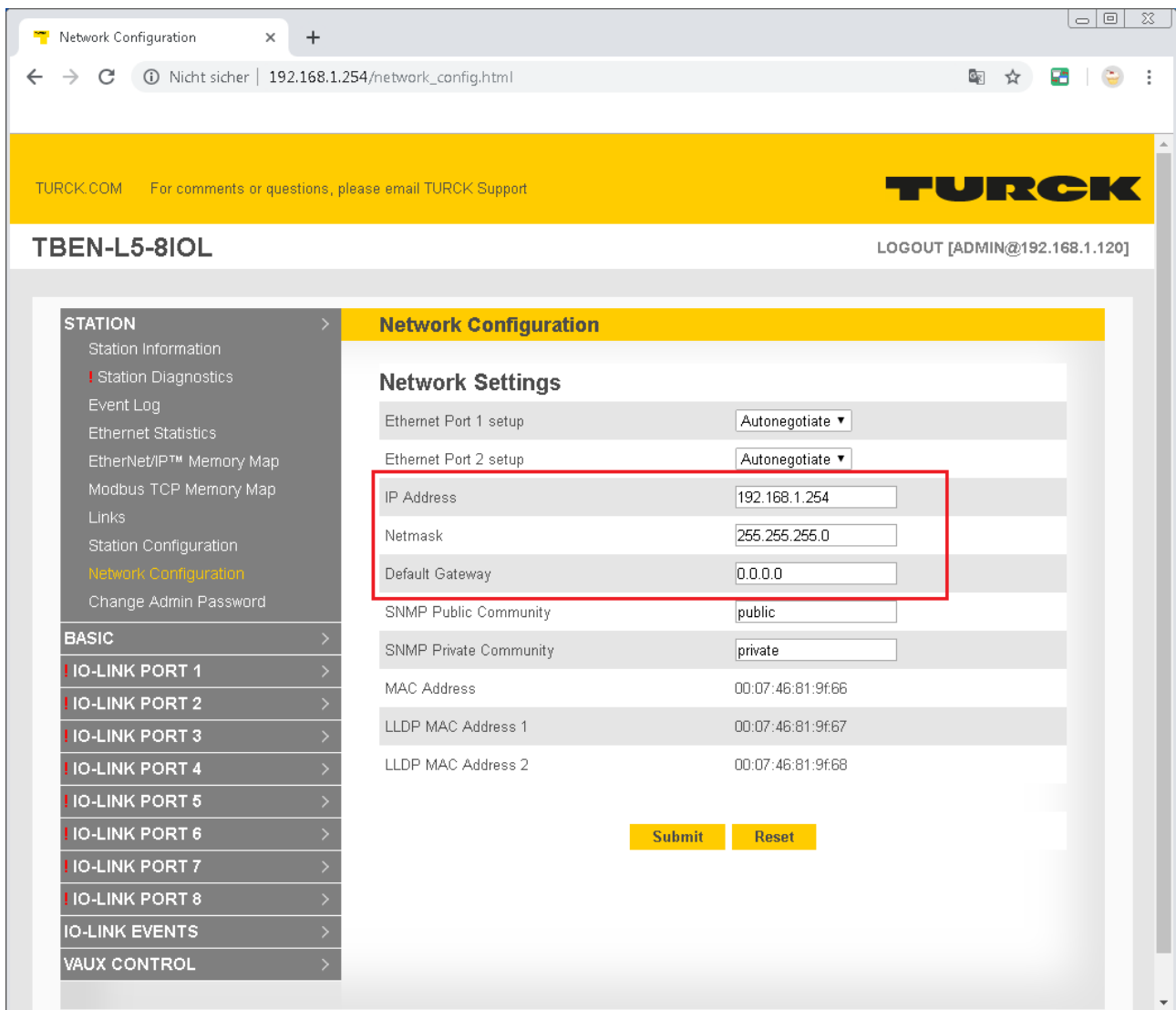

Fig. 25: Setting the IP Address via the Web Server

8.2 ARGEE/FLC

The ARGEE FLC programming software can be downloaded free of charge from www.turck.com.

The Zip archive "SW_ARGEE_Environment_Vx.x.zip" contains the software and the respective software documentation.

8.3 Commissioning an IO-Link device with IO-Link V1.0

IO-Link devices in accordance with IO-Link specification V1.0 do not support data storage. If an IO-Link V1.0 device is used, data storage at the IO-Link port must be deactivated.

- ▶ Set **Data storage mode** at the port to **deactivated, clear**.
- ▶ Load the parameter changes into the device.
- ▶ Connect the IO-Link V1.0 device.
- ⇒ The LED IOL at the IO-Link port is green, IO-Link communication active.

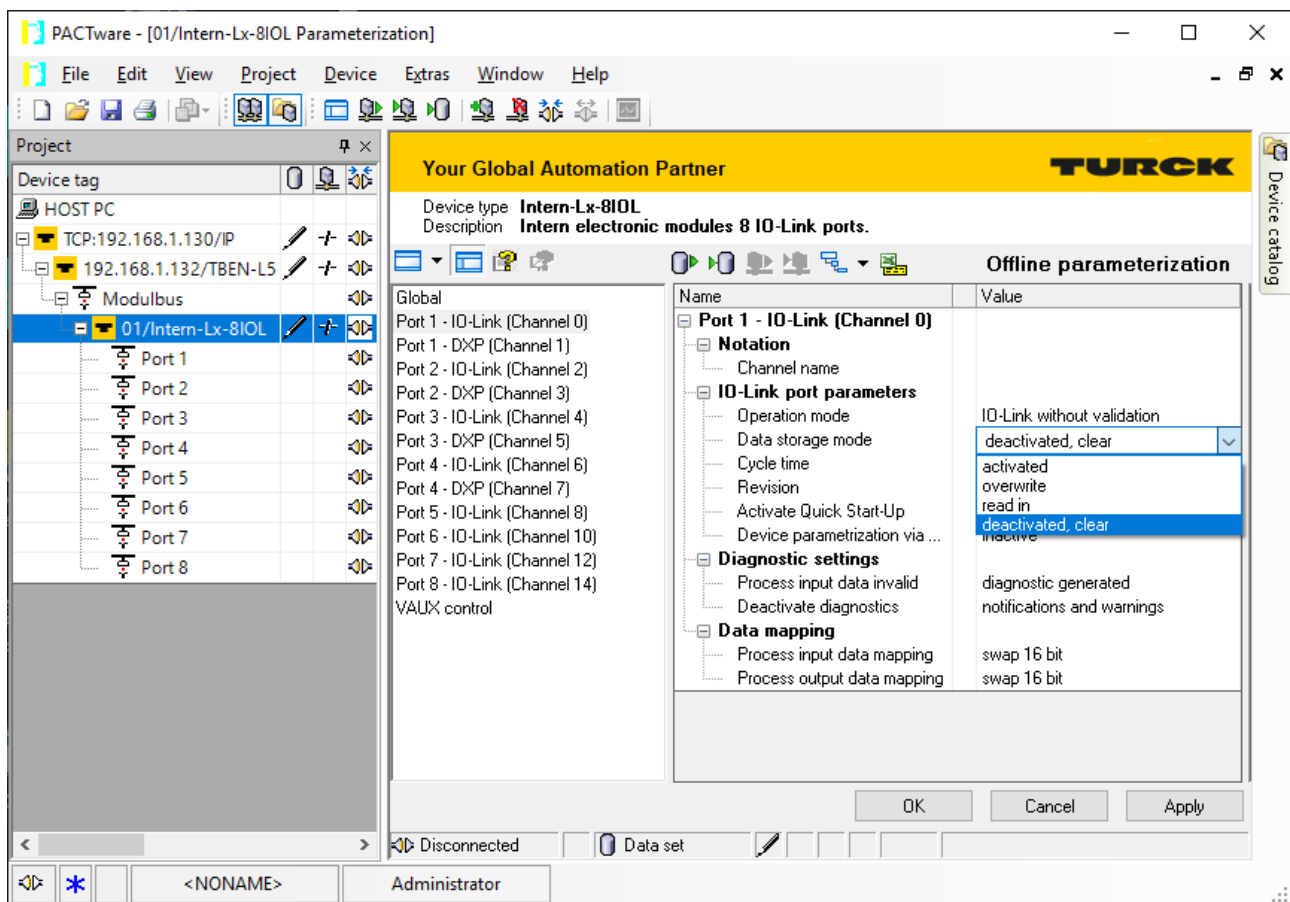

Fig. 26: Example: Deactivate or respectively delete the data storage mode with the DTM

8.4 Commissioning an IO-Link device with IO-Link V1.1

The data storage of the master should be cleared before a device with a different device type is connected to an IO-Link port which has already been used before.

The data storage memory of the master can be deleted in two ways:

- Reset the master to factory settings.
- Delete the data storage memory using the parameter **Data storage mode**.

Reset the master to factory settings via DTM

- ▶ From the **Factory settings** drop-down menu, select **Set to factory settings**.
- ▶ Load the parameter changes into the device.
- ⇒ The DTM resets the device automatically.

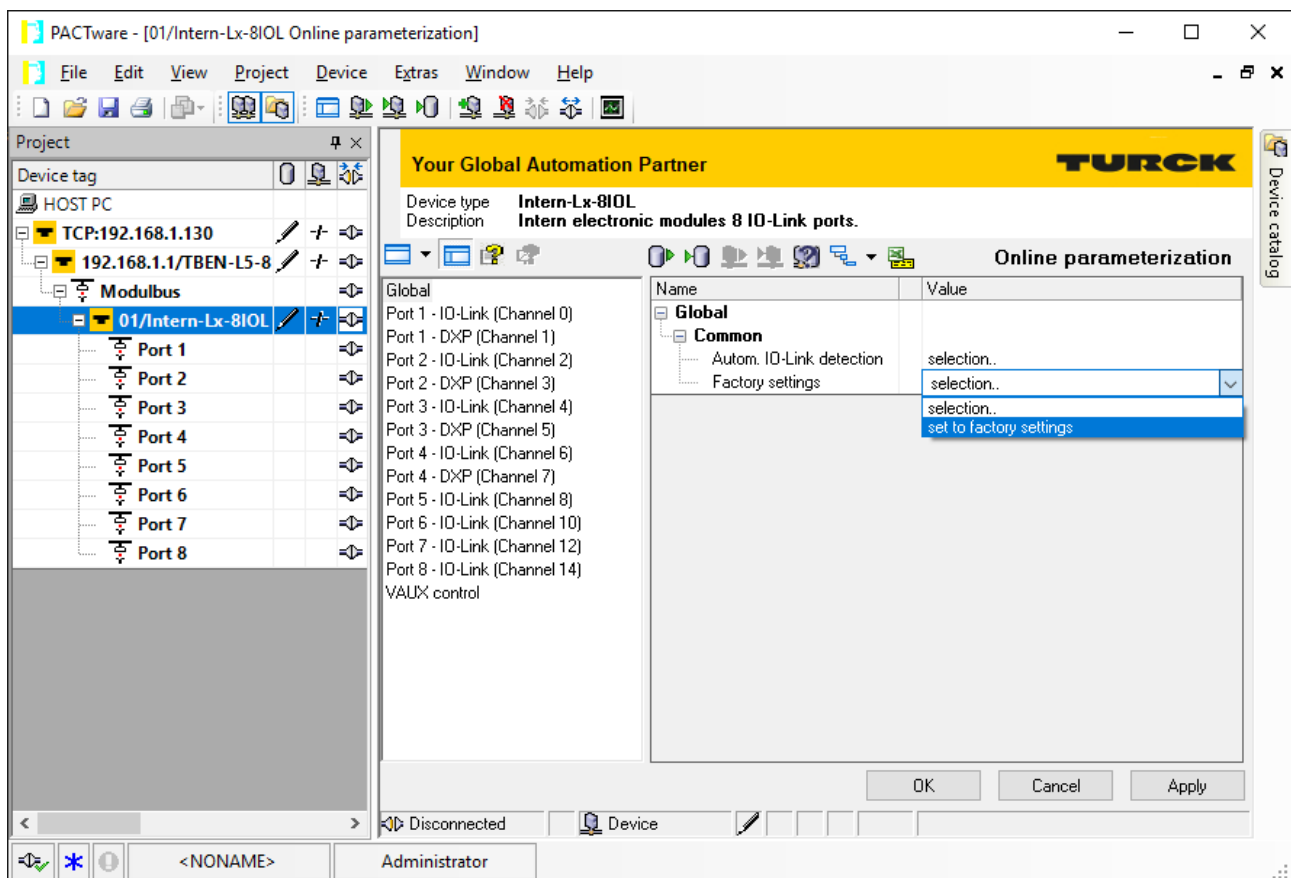

Fig. 27: Example: Reset device to factory settings via DTM

- ▶ Connect the IO-Link V1.1 device.
- ⇒ The LED IOL at the IO-Link port is green, IO-Link communication active.

Delete the data storage memory via parameters

- ▶ Set Data storage mode to **deactivated, clear**.
- ▶ Load the parameter changes into the device.
- ▶ Re-activate the data storage, if necessary.
- ▶ Load the parameter changes into the device.
- ▶ Connect the IO-Link V1.1 device.
- ⇒ The LED IOL at the IO-Link port is green, IO-Link communication active.

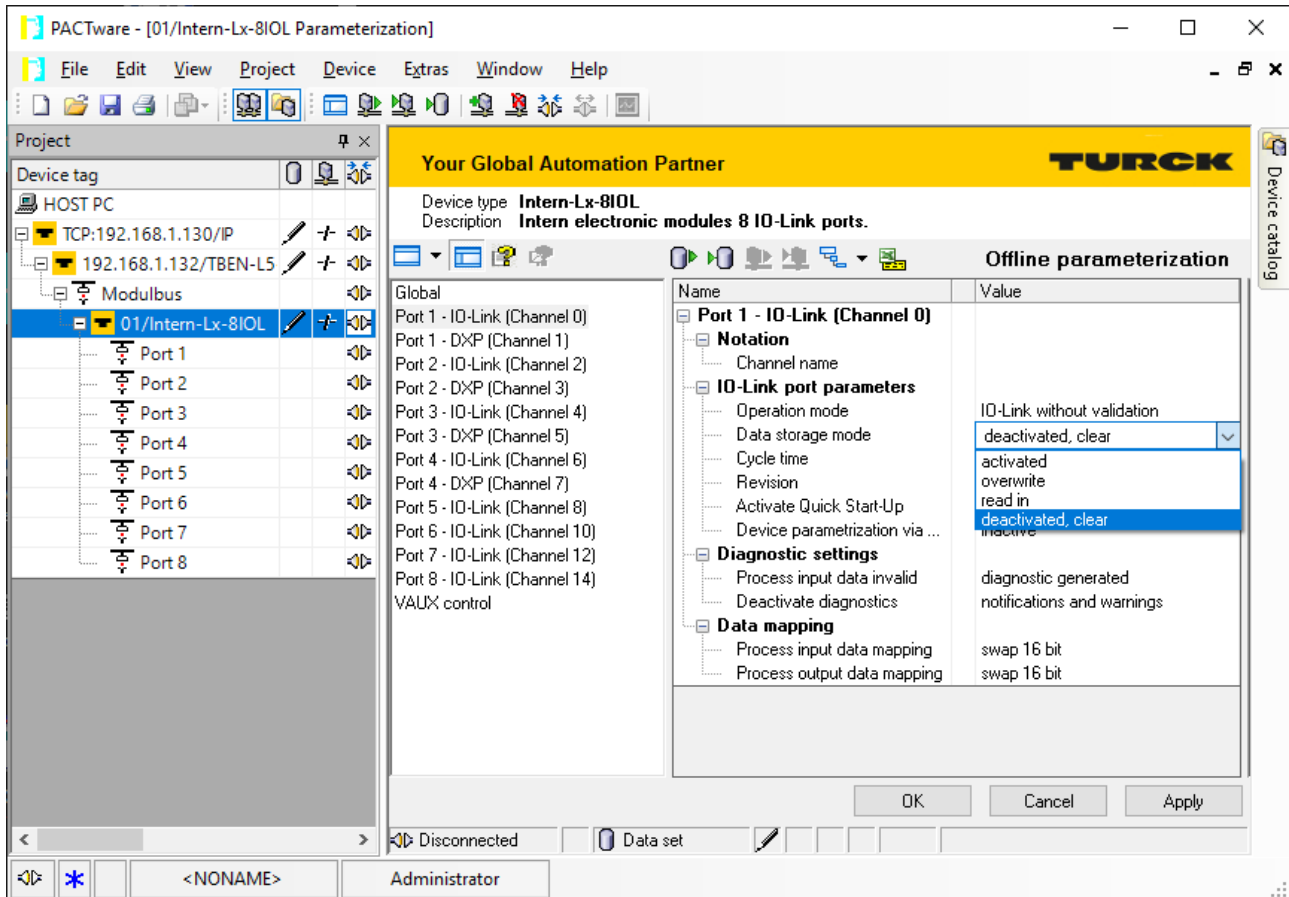

Fig. 28: Example: Deactivate or respectively delete the data storage mode with the DTM

8.5 Read in connected IO-Link devices: topology scan in the DTM

The Topology Scan in PACTware allows to read-in of an IO-Link configuration down to the IO-Link device. IO-Link device, known in PACTware, are added to the IO-Link ports of the master. Either the respective sensor DTMs in PACTware or the sensor IODDs via IODD DTM Configurator have to be installed.

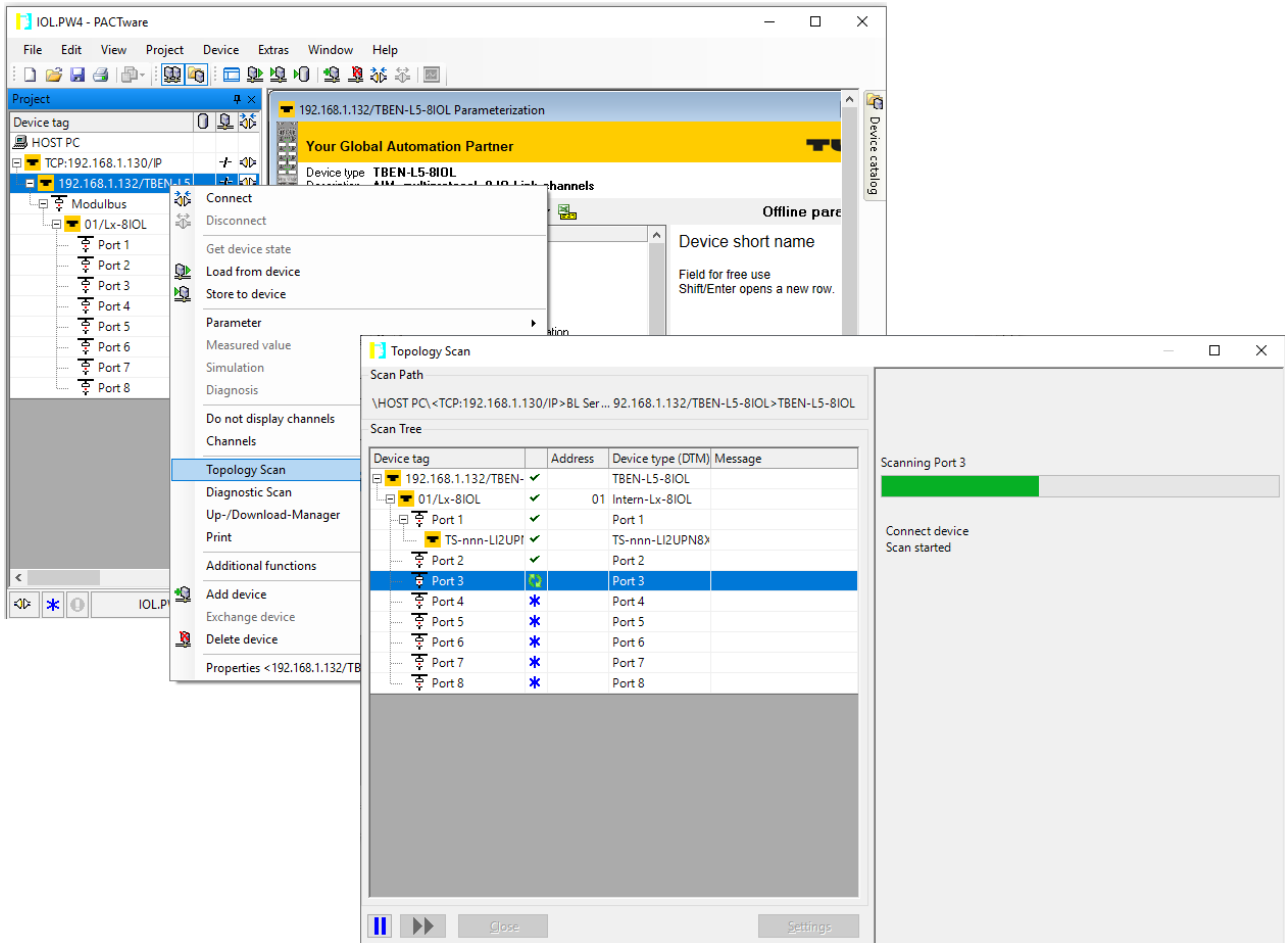

Fig. 29: PACTware – topology scan

8.6 Commissioning the device in PROFINET

8.6.1 PROFINET IO device model

The technical properties of PROFINET IO devices are defined via their device description file, the GSDML file. A PROFINET IO device consists of 1...n slots, which can also contain 1...n sub slots. Sub slots are placeholders for sub modules and establish the interface to the process. Sub modules can contain parameters, data and diagnostics.

Slot 0 is always reserved as Device Access Point (DAP). The DAP contains the physical interface to the Ethernet network and represents the device. The other slots and sub slots represent the other device functions. The structure is defined by the manufacturer of field devices. It is not necessary that every slot or respectively sub slot is related to physical functions. The allocation of the slots and sub slots and thus the assignment of functions (operation mode, diagnostics, etc.) is done in the configuration software of the PROFINET controller. This device model allows manufacturers to design modular and flexible decentral field devices. Users are flexible in configuring decentralized field devices.

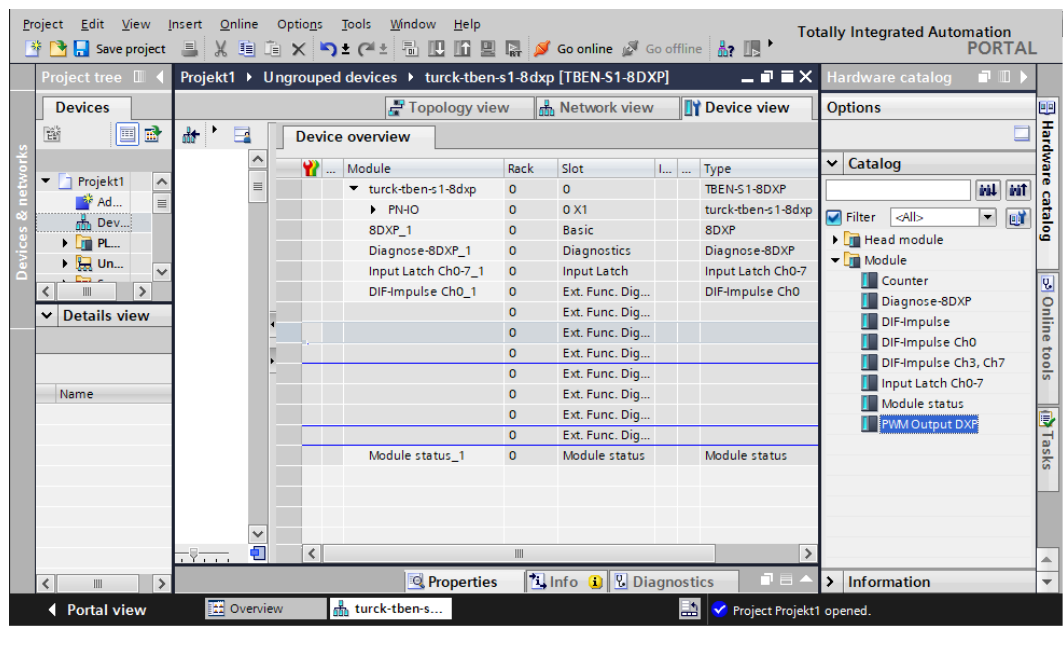

Fig. 30: TIA-Portal – assignment of the slots and sub slots on the example of an TBEN-S1-8DXP

8.6.2 Device model – TBEN-L...-8IOL

The TBEN-LL-8IOL provide eight parameterizable I/O-Link-channels and four universal I/O-channels (DXP). In addition to that, four virtual slots are provided via GSDML in PROFINET. Those channels are used to map the different diagnostic and status (IO-Link and VAUX diagnostics, IO-Link Events, module status) data into the master's process image .

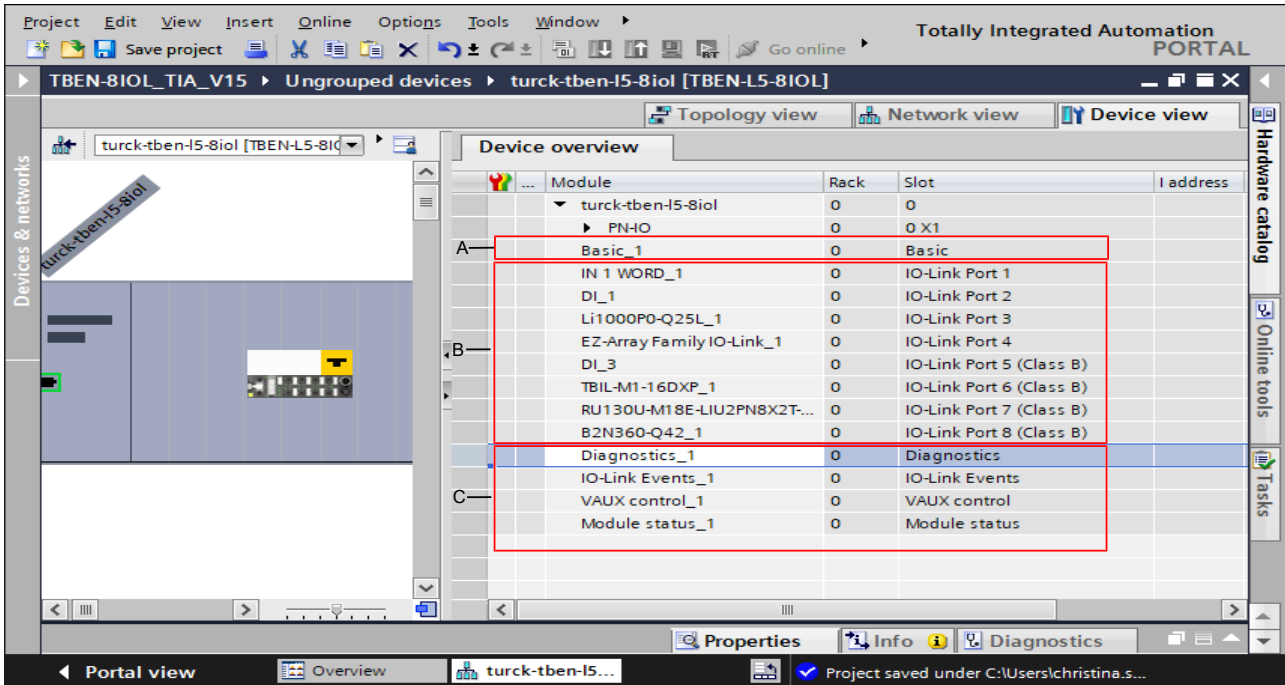

Fig. 31: TBEN-L5-8IOL – slot overview in TIA-Portal (example)

A	Basic slot for e. g. DXP-channels and Data Valid Signal
B	IO-Link ports for the configuration with specific IO-Link devices or for generic configuration
C	one slot each for diagnostics and status

8.6.3 Address setting in PROFINET

In IP-based communication, the field devices are addressed by means of an IP address. PROFINET uses the Discovery and Configuration Protocol (DCP) for IP assignment.

When delivered, each field device has, among other things, a MAC address. The MAC address is sufficient to give the respective field device a unique name.

The address is assigned in two steps:

- Assignment of a unique plant specific name to the respective field device.
- Assignment of the IP address from the IO-Controller before the system start-up based on the plant-specific (unique) name.

PROFINET naming convention

The names are assigned via DCP. The device name must meet the requirements of the Domain Name System (DNS) (see below). The device name is checked for correct spelling during input.



NOTE

The maximum length of the device name is 255 characters according to the specification. In a Step7 or TIA Portal environment, however, only names with a maximum length of 127 characters are accepted.

- All device names must be unique.
- Maximum name size: 255 or 127 characters (a...z, 0...9, "-" or "...")
- Do not use capital letters.
- The name must not begin or end with "-".
- Do not use special characters
- The name must not begin with 0...9 or "port-xyz" (xyz = 0...9).

8.6.4 FSU – Fast Start-Up (prioritized startup)

FSU - Fast Start-Up is not supported by device.

8.6.5 MRP (Media Redundancy Protocol)

The device supports MRP.

MRP is a standardized protocol according to IEC 62439. It describes a mechanism for media redundancy in ring topologies. With MRP, a defective ring topology with up to 50 nodes is detected and reconfigured in the event of an error. With MRP a trouble-free switch-over is not possible.

A Media Redundancy Manager (MRM) checks the ring topology of a PROFINET network defined by the network configuration for functionality. All other network nodes are Media Redundancy Clients (MRC). In the error-free state, the MRM blocks normal network traffic on one of its ring ports, with the exception of the test telegrams. The physical ring structure thus becomes a line structure again at the logical level for normal network traffic. If a test telegram fails to appear, a network error has occurred. In this case, the MRM opens its blocked port and establishes a new functioning connection between all remaining devices in the form of a linear network topology.

The time between ring interruption and recovery of a redundant path is called reconfiguration time. For MRP, this is a maximum of 200 ms. Therefore, an application must be able to compensate for the 200 ms interruption. The reconfiguration time always depends on the Media Redundancy Manager (e.g. the PROFINET PLC) and the I/O cycle and watchdog times set here. For PROFINET, the response monitoring time must be selected accordingly > 200 ms.

It is not possible to use Fast Start-Up in an MRP network.

8.6.6 User data for acyclic services

The acyclic data exchange is by using via Record Data CRs (Communication Relation). Via these Record Data CRs the reading and writing of the following services is realized:

- Writing of AR data
- Writing of configuration data
- Reading and writing of device data
- Reading of diagnostic data
- Reading of I/O data
- Reading of Identification Data Objects (I&M functions)

Acyclic device user data

Index		Name	Data type	Access	Comment
Dec.	Hex.				
1	0x01	Module parameters	WORD	read/write	Parameter data of the module (slot 0)
2	0x02	Module designation	STRING	read	Designation assigned to the module (slot 0)
3	0x03	Module revision	STRING	read	Firmware revision of the module
4	0x04	Vendor ID	WORD	read	Ident no. Turck
5	0x05	Module name	STRING	read	The device name assigned to the module
6	0x06	Module type	STRING	read	Device type of the module
7	0x07	Device ID	WORD	read	Ident no. of the module
8...23	0x08... 0x17	reserved	-	-	-
24	0x18	Module diagnostics	WORD	read	Diagnostic data of the module (slot 0).
25...31	0x19... 0x1F	reserved	-	-	-
32	0x20	Input list	ARRAY of BYTE	read	List of all module input channels
33	0x21	Output list	ARRAY of BYTE	read	List of all module output channels
34	0x22	Diag. list	ARRAY of BYTE	read	List of all I/O-channel diagnostics
35	0x23	Parameter list	ARRAY of BYTE	read	List of all I/O-channel parameters
36... 28671	0x24... 0x6FFF	reserved	-	-	-
28672	0x7000	Module parameters	WORD	read/write	Activate field bus protocol
28673... 45039	0x7001 ... 0xAFEF	reserved	-	-	-
45040	0xAFF0	I&M0-functions		read	Identification & Maintaining
45041	0xAFF1	I&M0-functions	STRING[54]	read/write	I&M Tag function and location

Index		Name	Data type	Access	Comment
45042	0xAFF2	I&M2-functions	STRING[16]	read/ write	I&M Installation Date
45043	0xAFF3	I&M3-functions	STRING[54]	read/ write	I&M Description Text
45044	0xAFF4	I&M4-functions	STRING[54]	read/ write	I&M Signature
45045... 45055	0xAFF5 ... 0xAFFF	I&M5 to I&M15- functions		-	not supported

Acyclic I/O channel user data

Index Dec.	Hex.	Name	Data type	Access	Comment
1	0x01	Module paramet- ers	specific	read/ write	Parameters of the module
2	0x02	Module type	ENUM UINT8	read	Contains the module type
3	0x03	Module version	UINT8	read	Firmware version of I/O channels
4	0x04	Module ID	DWORD	read	Ident number of the I/O
5...9	0x05 ... 0x09	reserved	-	-	-
10	0x0A	Slave controller version	UINT8 array [8]	read	Version number of the slave controller.
11...18	0x0B... 0x12	reserved	-	-	-
19	0x13	Input data	specific	read	Input data of the respective I/O-channel
20...22	0x14 ... 0x16	reserved	-	-	-
23	0x17	Output data	specific	read/ write	Output data of the respective I/O-channel
...	...	reserved	-	-	-

Index		Name	Data type	Access	Comment
Dec.	Hex.				
247	0xF7	CAP 1	Record	read/ write	Client access point for class 1 masters
248	0xF8	CAP 2	Record	read/ write	
249	0xF9	CAP 3	Record	read/ write	
250	0xFA	CAP 4	Record	read/ write	
251	0xFB	CAP 5	Record	read/ write	
252	0xFC	CAP 6	Record	read/ write	
253	0xFD	CAP 7	Record	read/ write	
254	0xFE	CAP 8	Record	read/ write	
255	0xFF	CAP 9	Record	read/ write	Client access point for class 2 masters

IM99 (IOL_M)

Name	Size	Data type	Default setting
IOL_LINK_VERSION	1 byte	UINT8	17 (0x11)
IO_LINK_PROFILE_VERSION	1 byte	UINT8	0 (0x00)
IO_LINK_FEATURE_SUPPORT	4 byte	UINT32	0 (0x00)
NUMBER_OF_PORTS	1 byte	UINT8	4 (0x04)
REF_PORT_CONFIG	1 byte	UINT8	0 (0x00)
REF_IO_MAPPING	1 byte	UINT8	0 (0x00)
REF_IOL_M	1 byte	UINT8	0 (0x00)
NUMBER_OF_CAP	1 byte	UINT8	5 (0x05)
INDEX_CAP1	1 byte	UINT8	247 (0xF7)
INDEX_CAP2	1 byte	UINT8	248 (0xF8)
INDEX_CAP3	1 byte	UINT8	249 (0xF9)
INDEX_CAP4	1 byte	UINT8	250 (0xFA)
INDEX_CAP5	1 byte	UINT8	251 (0xFB)
INDEX_CAP6	1 byte	UINT8	252 (0xFC)
INDEX_CAP7	1 byte	UINT8	253 (0xFD)
INDEX_CAP8	1 byte	UINT8	254 (0xFE)
INDEX_CAP9	1 byte	UINT8	255 (0xFF)

8.6.7 The IO-Link function block IOL_CALL

The IO-Link function block IOL_CALL is specified in the IO-Link specification "IO-Link Integration Part 1- Technical Specification for PROFIBUS and PROFINET".

Depending on the PLC manufacturer, the IO-Link CALL function block can differ from the specification (for example in the representation or the use of variables).

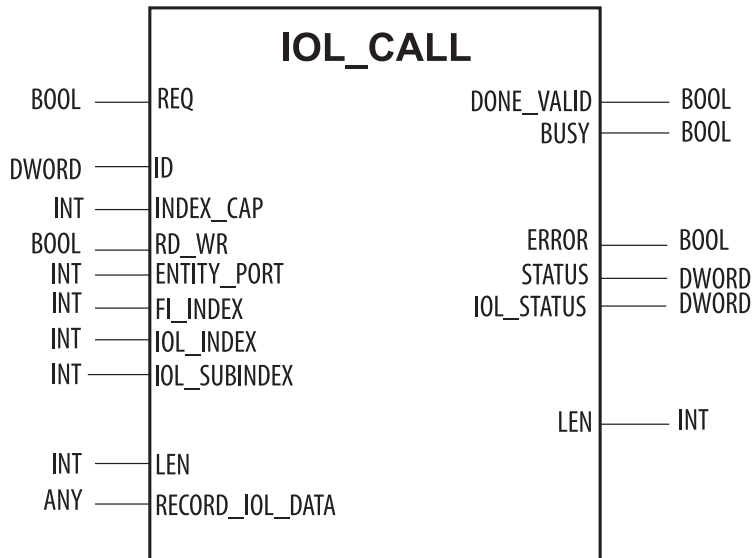

Fig. 32: IOL_CALL in accordance with IO-Link specification

IOL_CALL- input variables

Designation acc. IO-Link spec.	Data type	Meaning
REQ	BOOL	A rising edge triggers the send command.
ID	DWORD	Address of the IO-Link master module Step 7 Classic ■ Start address of the input data of the IO-Link master module. TIA Portal ■ older Siemens CPUs (e.g. CPU 315): Start address of the input data of the IO-Link master module. ■ recent Siemens CPUs (e.g. CPU 1511): HW identifier of the device's "Basic" slot
INDEX_CAP	INT	Function block instance: 247 to 254, 255
RD_WR	BOOL	0 = read access 1 = write access
ENTITY_PORT	INT	Address of the IO-Link port to be accessed
FI_INDEX	INT	Fix value (65098); defines the access to be an IO-Link CALL
IOL_INDEX	INT	Number of the IO-Link index which has to be read
IOL_SUBINDEX	INT	Definition of a possible sub index.
LEN	INT	Length of the data to be read/written. This information is not necessary for the Siemens IOL_CALL.
RECORD_IOL_DATA	ANY	Source/destination for the data to be read/written.

IOL_CALL – output variables

Designation acc. IO-Link spec.	Data type	Meaning
DONE_VALID	BOOL	The read or write access has been executed.
BUSY	BOOL	The read or write access is actually in progress.
ERROR	BOOL	Error while reading or writing.
STATUS	DWORD	Communication error status of the acyclic communication [▶ 45]
IOL_STATUS	DWORD	IO-Link error messages (in accordance with "IO-Link Integration Part 1- Technical Specification for PROFIBUS and PROFINET" and "IO-Link Interface and System"), which concern the communication between IO-Link master and connected devices [▶ 46].
LEN	INT	Length of the read data

IOL_CALL – communication error status

The status of the acyclic communication contains 4 byte and is structured as follows:

Byte 3	Byte 2	Byte 1	Byte 0
Manufacturer specific identifier (not always applicable)	0x80 Specifies the error as an error of acyclic communication.	Error code/ status code	Vendor specific identifier (not always applicable)

Status Code	Name	Meaning
0xFF000000	TIMEOUT	Internal error in the communication with the module
0x00FFF00	INVALID_HANDLE	
0x00FFFE00	HANDLE_OUT_OF_BUFFERS	
0x00FFFD00	HANDLE_DESTINATION_UNAVAILABLE	
0x00FFFC00	HANDLE_UNKNOWN	
0x00FFFB00	HANDLE_METHOD_INVALID	
0xFF80A0XX	MASTER_READ_ERROR	Error while reading
0xFF80A1XX	MASTER_WRITE_ERROR	Error while writing
0xFF80A2XX	MASTER_MODULE_FAILURE	Failure of the IO-Link master, bus failure possible
0xFF80A6XX	MASTER_NO_DATA	No data received
0xFF80A7XX	MASTER_BUSY	IO-Link master busy
0xFF80A9XX	MASTER_FEATURE_NOT_SUPPORTED	Function not supported by IO-Link master.
0xFF80AAXX	MASTER_RESOURCE_UNAVAILABLE	IO-Link master not available.
0xFF80B0XX	ACCESS_INVALID_INDEX	Index invalid, wrong INDEX_CAP used
0xFF80B1XX	ACCESS_WRITE_LENGTH_ERROR	Length of data to be written can not be handled from the module, wrong module accessed.

Status Code	Name	Meaning
0xXX80B2XX	ACCESS_INVALID_DESTINATION	Wrong slot accessed
0xXX80B03XX	ACCESS_TYPE_CONFLICT	IOL_CALL invalid
0xXX80B5XX	ACCESS_INVALID_INDEX	Error in IOL_CALL sequence
0xXX80B6XX	ACCESS_DENIED	IOL-Link master module refuses the access.
0xXX80C2XX	RESOURCE_BUSY	The IO-Link master module is busy or is waiting for an answer of the connected IO-Link device.
0xXX80C3XX	RESOURCE_UNAVAILABLE	The index to be read contains more data than defined in the input variable "LEN".
0xXX8901XX	INPUT_LEN_TOO_SHORT	The index to be read contains more data than defined in the input variable "LEN".

IOL_CALL – IOL_STATUS

The IOL_STATUS consists of 2 byte Error Code (IOL_M Error_Codes, according to "IO-Link Integration Part 1- Technical Specification for PROFIBUS and PROFINET") and 2 byte Error Type (according to "IO-Link Interface and System").

Byte 3	Byte 2	Byte 1	Byte 0
IOL_M-Error-Code		IOL-Error Type	

IOL_M-Error-Code	Designation acc. to IO-Link Spec.	Meaning
0x0000	No error	No error
0x7000	IOL_CALL Conflict	Unexpected write-request, read request expected
0x7001	Wrong IOL_CALL	Decoding error
0x7002	Port blocked	The accessed port is occupied by another task
...	reserved	
0x8000	The accessed port is occupied by another task	Timeout, IOL master or IOL device port busy
0x8001	Wrong index	Error: IOL index < 32767 or > 65535 selected
0x8002	Wrong port address	Port address not available
0x8003	Wrong port function	Port function not available
...	reserved	

IOL-Error Type	Designation acc. to IO-Link Spec.	Meaning
0x1000	COM_ERR	Communication error Possible source: the addressed port is parameterized as digital input DI and is not in IO-Link mode
0x1100	I_SERVICE_TIMEOUT	Timeout in communication, device does not respond in time
0x5600	M_ISDU_CHECKSUM	Master reports checksum error, access to device not possible
0x5700	M_ISDU_ILLEGAL	Device can not respond to master request
0x8000	APP_DEV	Application error in the device
0x8011	IDX_NOTAVAIL	Index not available

IOL-Error Type	Designation acc. to IO-Link Spec.	Meaning
0x8012	SUBIDX_NOTAVAIL	Sub-Index not available
0x8020	SERV_NOTAVAIL	The service is temporarily not available.
0x8021	SERV_NOTAVAIL_LOCCTRL	Service temporarily not available, device is busy (e. g. teaching or parameterization of the device via the master active)
0x8022	SERV_NOTAVAIL_DEVCTRL	Service temporarily not available, device is busy (e. g. teaching or parameterization of the device via DTM/PLC etc. active)
0x8023	IDX_NOT_WRITEABLE	Access denied, Index cannot be written
0x8030	PAR_VALOUTOFRNG	Parameter value out of the valid range
0x8031	PAR_VALGTLIM	Parameter value above the upper limit
0x8032	PAR_VALLTLM	Parameter value value below the lower limit
0x8033	VAL_LENVERRUN	Length of data to be written does not match the length defined for this parameter
0x8034	VAL_LENUNDRUN	
0x8035	FUNC_NOTAVAIL	Function not available in the device
0x8036	FUNC_UNAVAILTEMP	Function temporarily unavailable in the device
0x8040	PARA_SETINVALID	Invalid parameter: Parameters not consistent with other parameters in the device.
0x8041	PARA_SETINCONSIST	Inconsistent parameters
0x8082	APP_DEVNOTRDY	Application not ready, device busy
0x8100	UNSPECIFIC	Vendor specific, according to device documentation
0x8101...0x8FF	VENDOR_SPECIFIC	

8.7 Connecting the device to a Siemens PLC in PROFINET

The following example describes the connection of the devices to a Siemens PLC in PROFINET by means of the programming software SIMATIC STEP7 Professional V15 (TIA-Portal).

Used Hardware

The following hardware components are used in this example:

- Siemens PLC S7-1500
- IO-Link master TBEN-L5-8IOL with the following configuration:
 - Port 1: Turck temperature sensor, TS-530-LI2UPN8X-..., IO-Link V1.0
 - Port 2: Channel used as DI
 - Port 3: Turck linear position sensor, Li100P0-Q25LM0-..., IO-Link V1.0
 - Port 4: Channel used as DI
 - Port 5: Channel used as DI
 - Port 6: Turck IO-Link hub: TBIL-M1-16DXP, IO-Link V1.1
 - Port 7: Turck ultra sonic sensor, RU130U-M18E-..., IO-Link V1.1
 - Port 8: Turck ultra sonic sensor, B2N360-Q42-..., IO-Link V1.1

Used Software

The following software tools are used in this example:

- SIMATIC STEP7 Professional V15 (TIA-Portal)
- GSDML file for TBEN-L...-8IOL (can be downloaded for free as ZIP archive "TBEN-L_PROFINET.zip" under www.turck.com)

Prerequisites

- The programming software has been started.
- A new project has been created.
- The PLC has been added to the project.

8.7.1 Installing the GSDML file

The GSDML file can be downloaded for free from www.turck.com .

- ▶ Adding the GSDML-file: Click "Options" → "Manage general station description files (GSD)".
- ▶ Installing the GSDML-file: Define the source path for the GSDML-file and click **Install**.
- ⇒ The device is added to the Hardware catalog of the programming software.

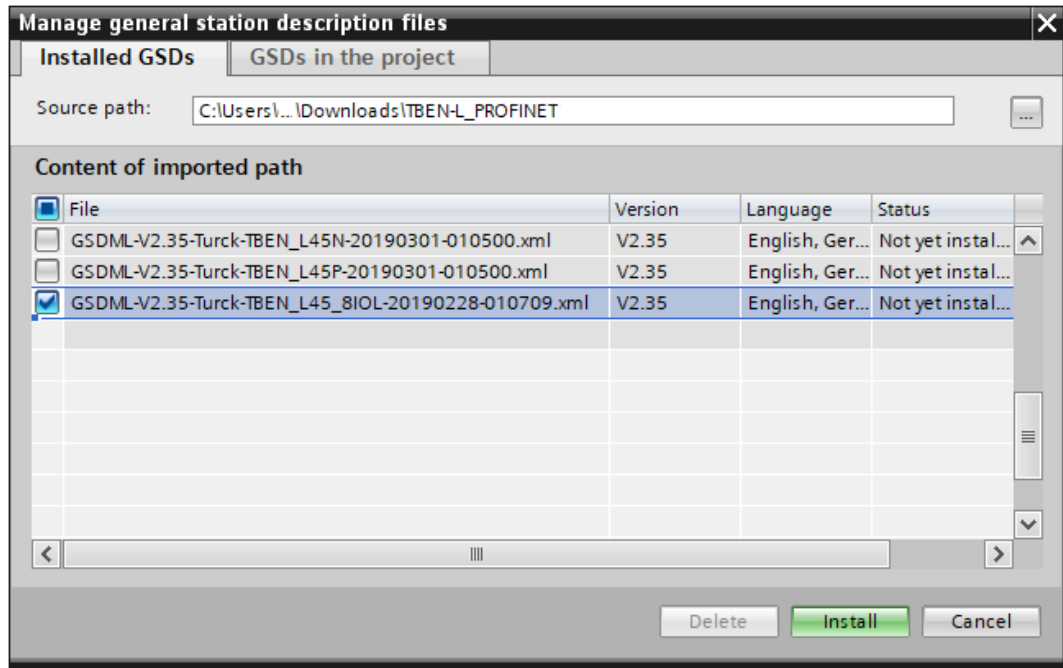

Fig. 33: Installing the GSDML-file

8.7.2 Connecting the devices to the PLC

- ▶ Select the TBEN-...-8IOL from the Hardware catalog and drag them into the "Device & networks" editor.
- ▶ Connect the devices to the PLC in the "Devices & networks" editor.

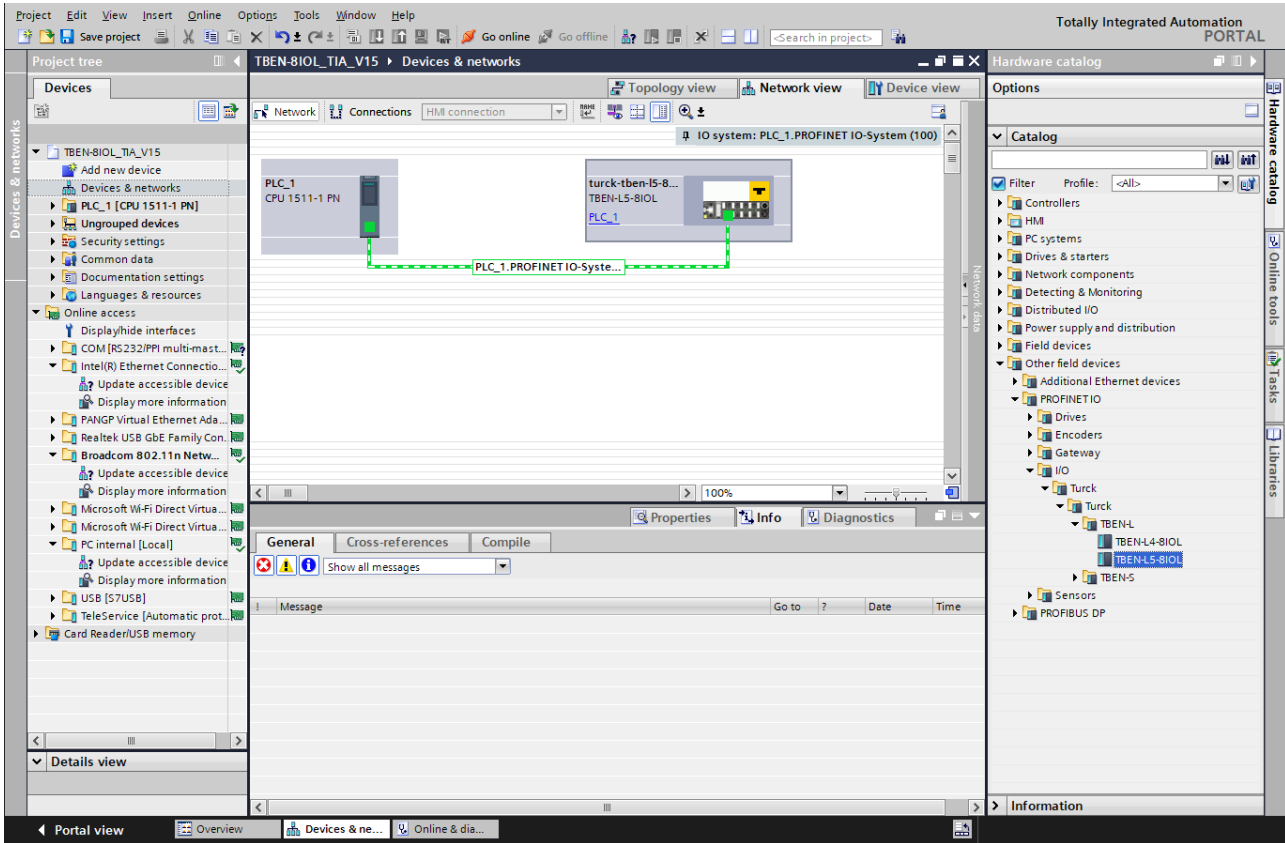

Fig. 34: Connecting the device to the PLC

8.7.3 Assigning the PROFINET device name

- ▶ Select **Online access** → **Online & diagnostics**.
- ▶ **Functions** → **Assign PROFINET device name**.
- ▶ Assign the desired PROFINET device name with **Assign name**.

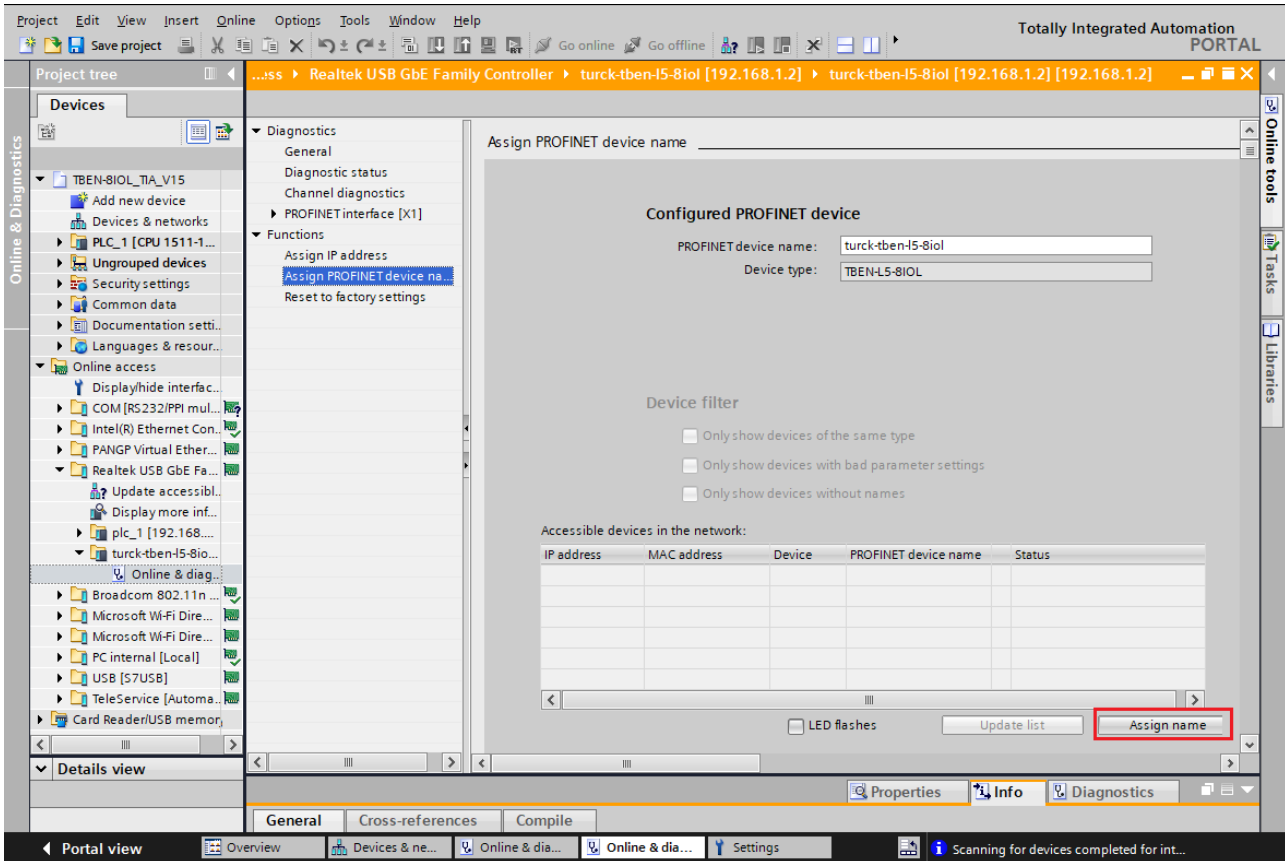

Fig. 35: Assigning the PROFINET device name

8.7.4 Setting the IP address in TIA Portal

- ▶ Select Device view → Properties → Ethernet addresses.
- ▶ Assign the desired IP address.

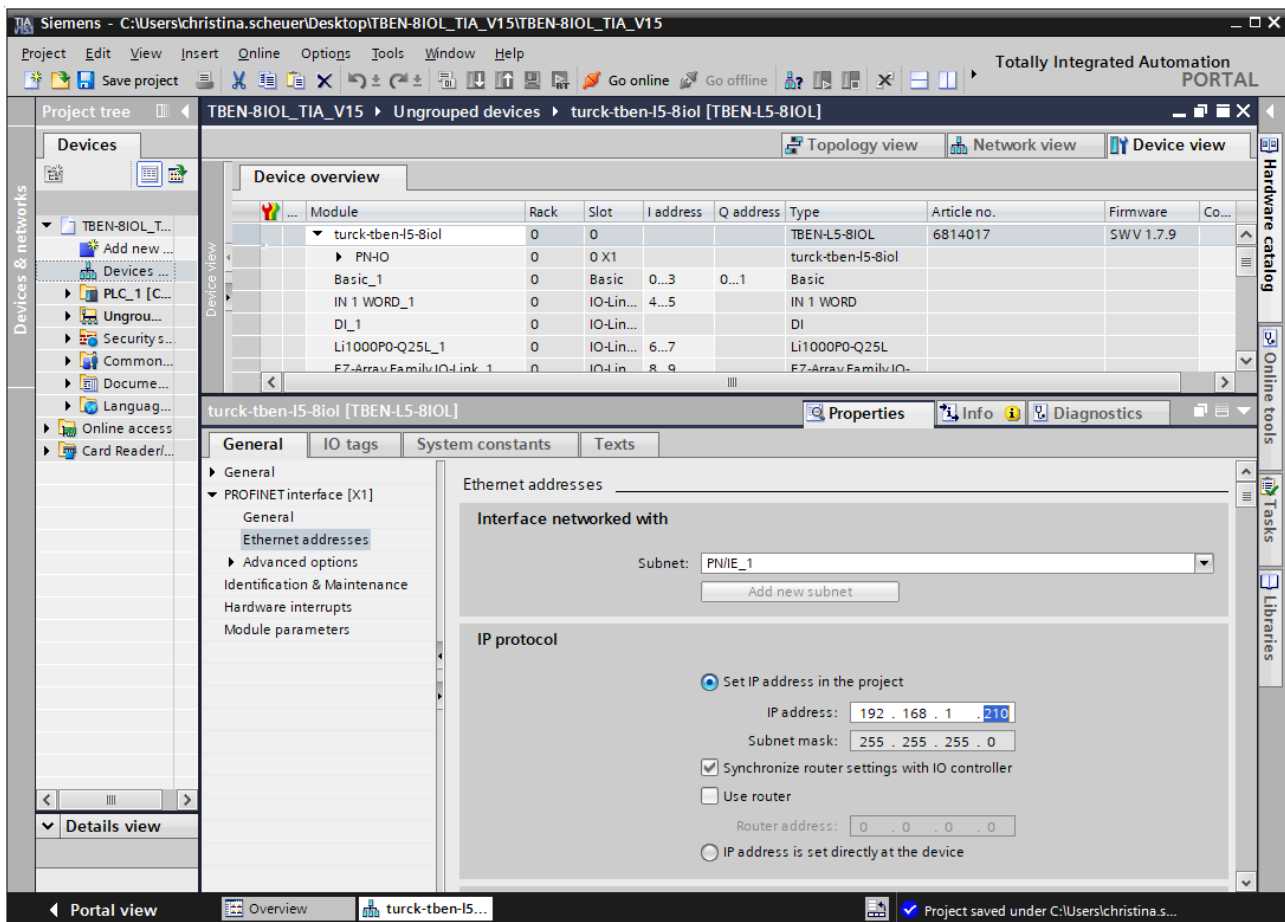

Fig. 36: Assigning the IP address

8.7.5 Configuring device functions

The TBEN-LL-8IOL appears as a modular slave with twelve empty virtual slots. Slots 0 and Basic are pre-configured.

The function of the twelve empty slots is already defined in the GSDML file. The slots can only be used for a specific purpose.

Slot	Meaning
0	Main module turck-tben-l5-8iol (default name) Parameterization of functions (protocol deactivation, etc.), which concern the complete module.
XI	Parameterization of PROFINET functions (MRP, etc.)
X1 P1	Parameterization of the Ethernet port properties (topology, connection options etc.).
X1 P2	
Basic	Parameters/diagnostics for the DXP-channels of the device (DXP 1, 3, 5 and 7) and Data Valid Signal from the IO-Link ports.
IO-Link port 1...8	Configuration of the eight IO-Link ports
Diagnostics	Optional mapping of the diagnostics (IO-Link and DXP-diagnostics) into the master's process image.
IO-Link Events	Optional mapping of the IO-Link events into the master's process image.
VAUX Control	Optional mapping of the VAUX diagnostics into the master's process image.
Module status	Optional mapping of the module status into the masters process image.

Configuring IO-Link ports (example)

IO-Link-Port (Hardware)	Process data length	IO-Link device	GSDML entry
Port 1	2 byte IN	Turck temperature sensor, TS-530-LI2UPN8X-...	Port-configuration generic: IN 1 WORD
Port 2	1 Bit IN	-	DI
Port 3	2 byte IN	Turck linearity sensor, Li100P0-Q25LM0-...	Port-configuration specific: Li100P0-QU25L
Port 4	2 byte IN 2 byte OUT	Turck I/O hub, TBIL-M1-16DXP	Port configuration specific: TBIL-M1-16DXP
Port 5	1 Bit IN	-	DI
Port 6	1 Bit IN	-	DI
Port 7	1 Bit IN	Turck ultrasonic sensor, RU130U-M18E-...	Port-configuration specific: RU40U-M18E-LiU2PN...(DI) The IO-Link port is configured as digital input only.
Port 8	4 byte IN	Turck inclinometer, B2N360-Q42-...,	Port-configuration specific: B2N360-Q42-E2LiUPN8X2

- ▶ Select **Device view** → **Device overview**.
- ▶ Select functions as operation mode, diagnostics etc. from the hardware catalog and add them to the device slots via drag&drop.

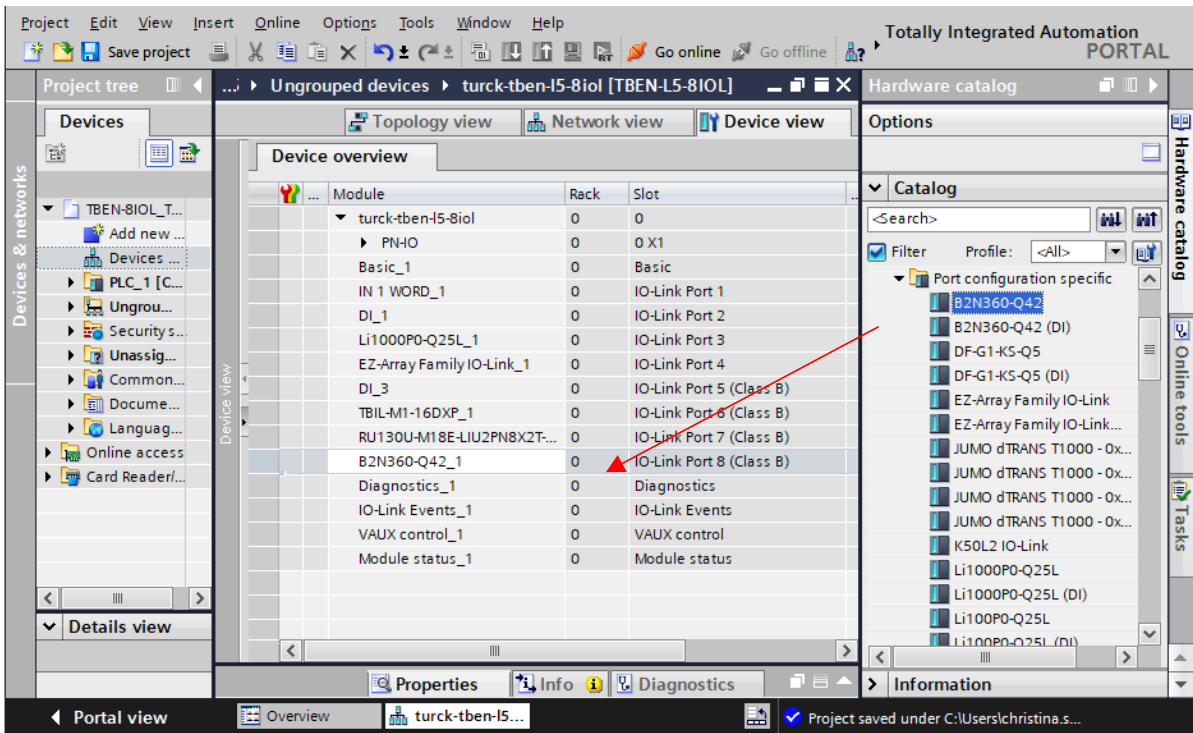

Fig. 37: TIA-Portal – configuring device slots

Setting IO-Link Port Parameters

In generic port configuration, the ports of the IO-Link master can be operated in IO-Link mode with different configuration as well as in SIO mode (DI).

In specific port configuration, the IO-Link ports receive the parameters from the GSDML-file. Parameters like for example Operation mode, Data storage mode, Vendor- and Device ID cannot be changed.

- ▶ Select **Device view** → **Device overview**.
- ▶ Select the device to be parameterized.
- ▶ Click **Properties** → **General** → **Module parameters**.
- ▶ Set the device parameters.

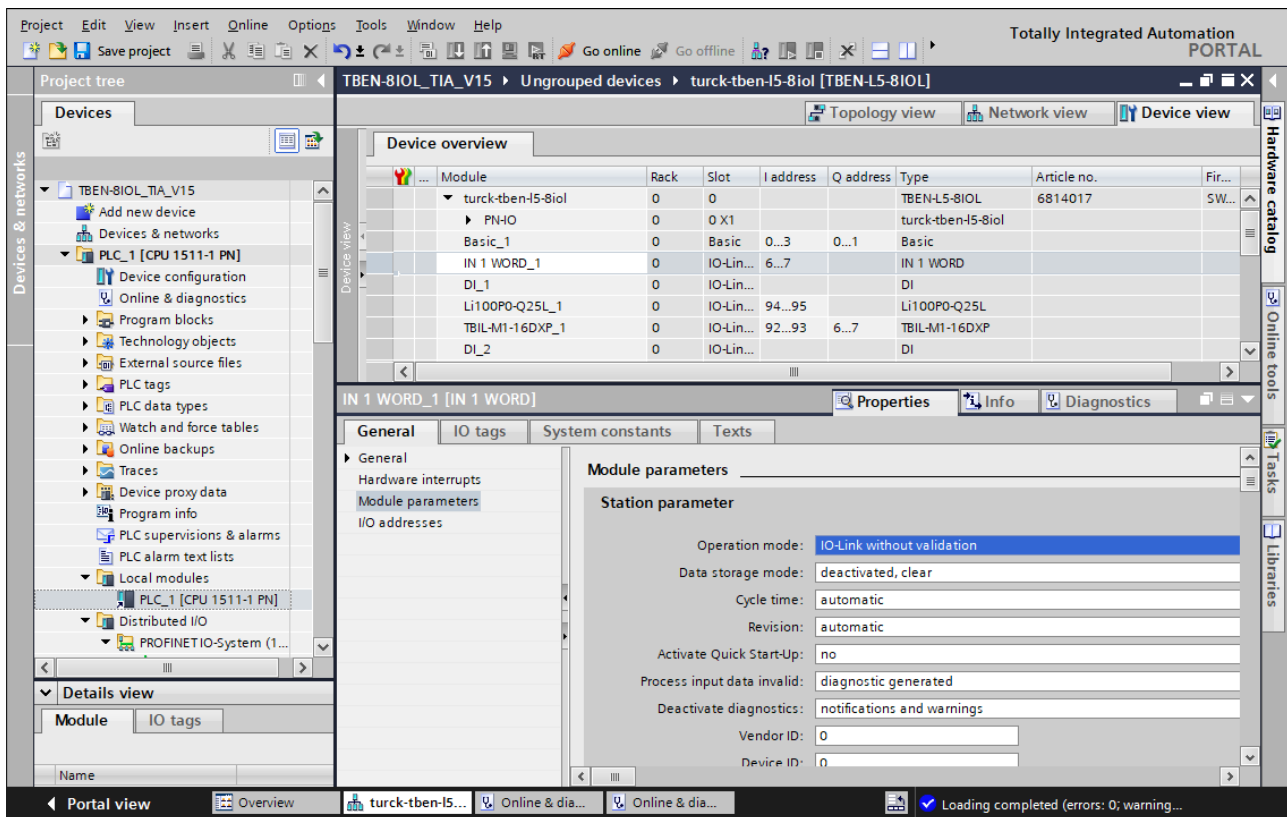

Fig. 38: TIA-Portal – Parametrieren generischer IO-Link-Devices

8.7.6 Going online with the PLC

- ▶ Start the online mode (Go online).
- ⇒ The device has been successfully connected to the PLC.

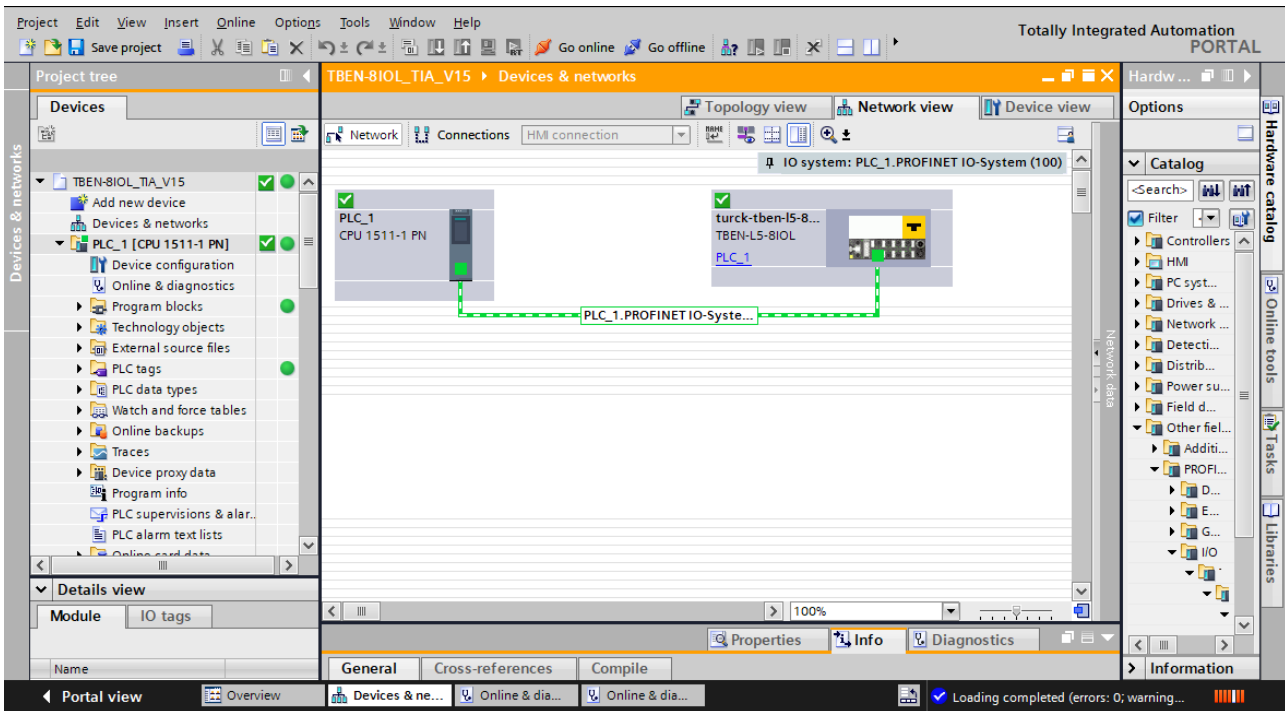

Fig. 39: Starting the online mode

8.7.7 PROFINET – mapping

The PROFINET mapping corresponds to the data mapping described in the sections "Process Input Data" [▶ 127] and „Process Output Data" [▶ 129].

8.7.8 Use the IO_LINK_DEVICE function block in TIA Portal

The IO_LINK_DEVICE function block is based on the IOL_CALL function block according to the IO-Link specification.

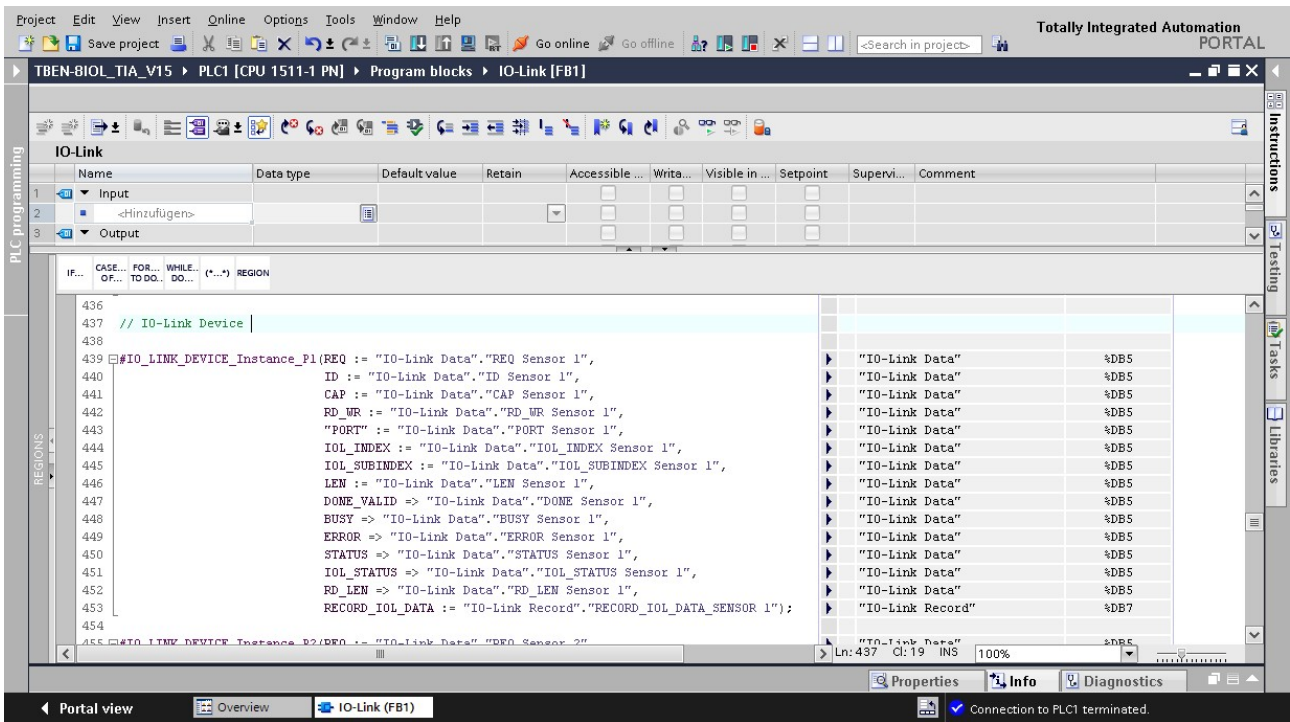

Fig. 40: Example call of Siemens FB "IO_LINK_DEVICE"



NOTE

The access to the port 0 functions of the IO-Link master with an IOL_INDEX of 65535 is not possible with version V3.0.2 of the Siemens IO_LINK_DEVICE block. In TIA-Portal V15, the old IOL_CALL function block can be used to access the port 0 functions. Siemens provides the function block for TIA-Portal users under <https://support.industry.siemens.com>.

Example accesses with IO_LINK_DEVICE

In this example, the watch table **Sensor1** serves to visualize the procedure of the read and write access via IO_LINK_DEVICE. The assignment of the SPDU-indices of IO-Link devices can be found in the respective device documentation.

The function block access to the device and the connected sensors is done via the input variable **ID**. The value which has to be set as ID depends on the used CPU:

Example:

- HW identifier of the **basic** slot (slot 1), for example with CPU 1511-PN (used in this example)
- Start address of the input data of the IO-Link master e.g. with CPU 315

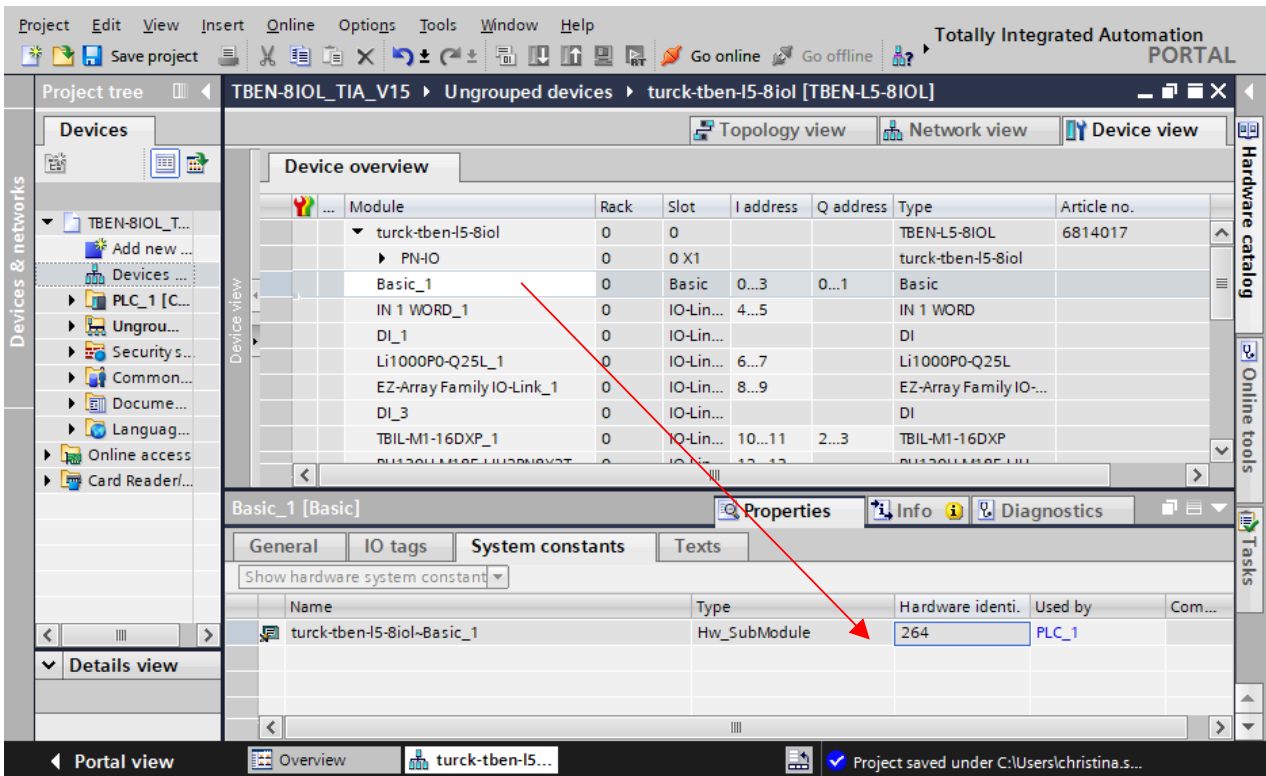

Fig. 41: Hardware identifier: Basic slot of the TBEN-L...-8IOL in the example

Example read access – read product name

Reading out the product name (product name, index 0x12) of the TURCK IO-Link I/O-hub TBIL-M1-16DXP at IO-Link port 4.

- ▶ Write the input variables of the function block via **control variable** as follows:

Variable	Value	Meaning
REQ	TRUE	Send a read request
ID	264	Hardware identifier of the "Basic" slot according to the configuration in the Device view
CAP	251	Function block instance
PORT	4	The I/O hub TBIL-M1-16DXP is connected to port 4.
IOL_INDEX	0x12	Index for product name

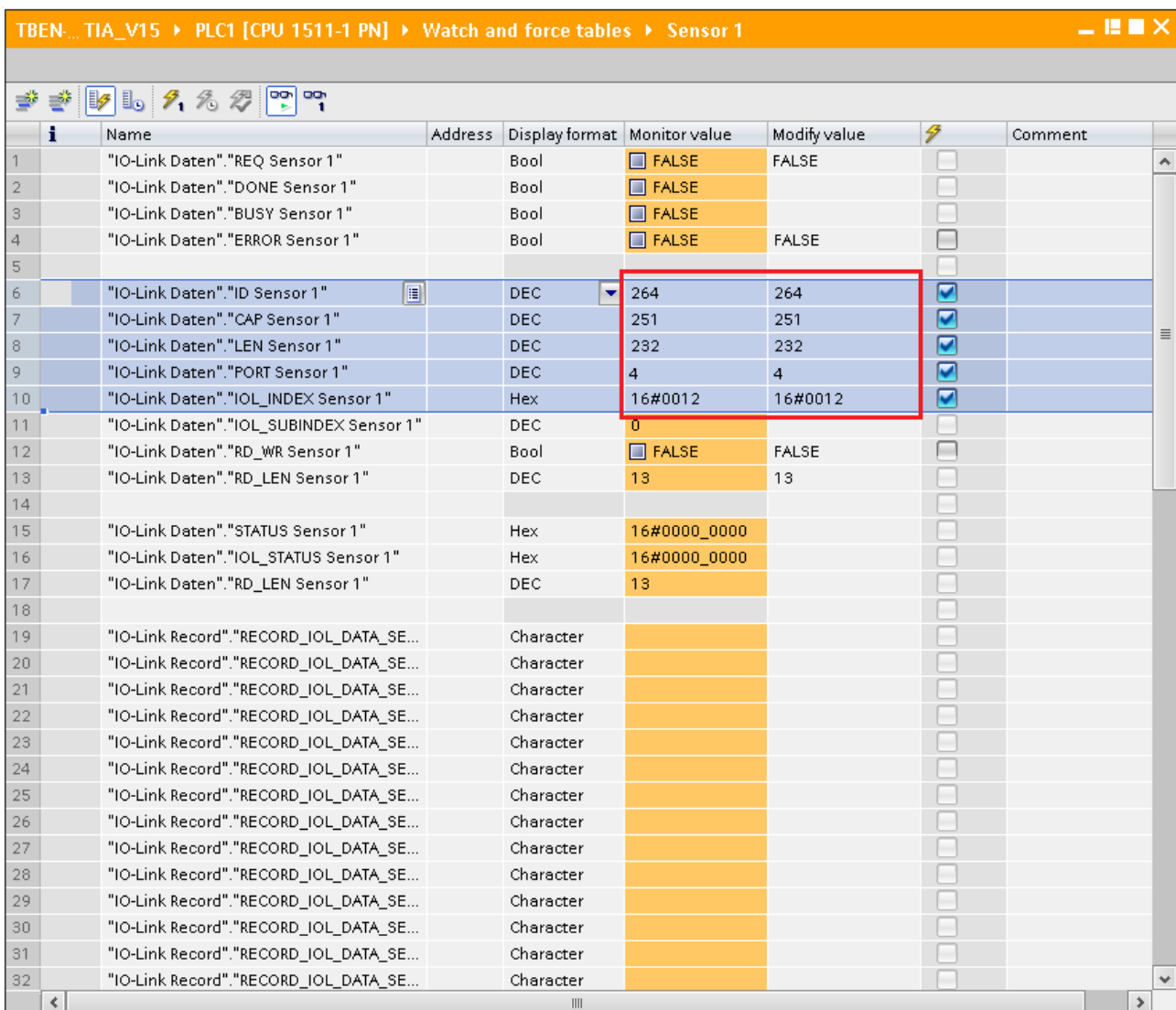

Fig. 42: IO_LINK_DEVICE – input variables for read access

- ▶ Activate the read access via a rising edge at REQ.

	Name	Address	Display format	Monitor value	Modify value		Comment
1	"IO-Link Daten"."REQ Sensor 1"		Bool	<input checked="" type="checkbox"/> TRUE	TRUE	<input checked="" type="checkbox"/>	0 => 1 start CALL
2	"IO-Link Daten"."DONE Sensor 1"		Bool	<input checked="" type="checkbox"/> TRUE		<input type="checkbox"/>	
3	"IO-Link Daten"."BUSY Sensor 1"		Bool	<input type="checkbox"/> FALSE		<input type="checkbox"/>	
4	"IO-Link Daten"."ERROR Sensor 1"		Bool	<input type="checkbox"/> FALSE	FALSE	<input type="checkbox"/>	
5						<input type="checkbox"/>	
6	"IO-Link Daten"."ID Sensor 1"		DEC	264	264	<input type="checkbox"/>	
7	"IO-Link Daten"."CAP Sensor 1"		DEC	251	251	<input type="checkbox"/>	

Fig. 43: IO_LINK_DEVICE – activate read access

- ⇒ In this example, the result of this request can be seen in the watch table (row 19 and following) in the IO-Link Record.

	Name	Address	Display format	Monitor value	Modify value		Comment
1	"IO-Link Daten"."REQ Sensor 1"		Bool	<input checked="" type="checkbox"/> TRUE	TRUE	<input checked="" type="checkbox"/>	0 => 1 start CALL
2	"IO-Link Daten"."DONE Sensor 1"		Bool	<input checked="" type="checkbox"/> TRUE		<input type="checkbox"/>	
3	"IO-Link Daten"."BUSY Sensor 1"		Bool	<input type="checkbox"/> FALSE		<input type="checkbox"/>	
4	"IO-Link Daten"."ERROR Sensor 1"		Bool	<input type="checkbox"/> FALSE	FALSE	<input type="checkbox"/>	
5						<input type="checkbox"/>	
6	"IO-Link Daten"."ID Sensor 1"		DEC	264	264	<input type="checkbox"/>	
7	"IO-Link Daten"."CAP Sensor 1"		DEC	251	251	<input type="checkbox"/>	
8	"IO-Link Daten"."LEN Sensor 1"		DEC	232	232	<input type="checkbox"/>	
9	"IO-Link Daten"."PORT Sensor 1"		DEC	4	4	<input type="checkbox"/>	
10	"IO-Link Daten"."IOL_INDEX Sensor 1"		Hex	16#0012	16#0012	<input type="checkbox"/>	
11	"IO-Link Daten"."IOL_SUBINDEX Sensor 1"		DEC	0		<input type="checkbox"/>	
12	"IO-Link Daten"."RD_WR Sensor 1"		Bool	<input type="checkbox"/> FALSE	FALSE	<input type="checkbox"/>	
13	"IO-Link Daten"."RD_LEN Sensor 1"		DEC	13	13	<input checked="" type="checkbox"/>	
14						<input type="checkbox"/>	
15	"IO-Link Daten"."STATUS Sensor 1"		Hex	16#0000_0000		<input type="checkbox"/>	
16	"IO-Link Daten"."IOL_STATUS Sensor 1"		Hex	16#0000_0000		<input type="checkbox"/>	
17	"IO-Link Daten"."RD_LEN Sensor 1"		DEC	13		<input type="checkbox"/>	
18						<input type="checkbox"/>	
19	"IO-Link Record"."RECORD_IOL_DATA..."		Character	'T'	'\$00'	<input type="checkbox"/>	
20	"IO-Link Record"."RECORD_IOL_DATA_SE..."		Character	'B'	'\$00'	<input type="checkbox"/>	
21	"IO-Link Record"."RECORD_IOL_DATA_SE..."		Character	'I'	'\$00'	<input type="checkbox"/>	
22	"IO-Link Record"."RECORD_IOL_DATA_SE..."		Character	'L'	'\$00'	<input type="checkbox"/>	
23	"IO-Link Record"."RECORD_IOL_DATA_SE..."		Character	'M'	'\$00'	<input type="checkbox"/>	
24	"IO-Link Record"."RECORD_IOL_DATA_SE..."		Character	'1'	'\$00'	<input type="checkbox"/>	
25	"IO-Link Record"."RECORD_IOL_DATA_SE..."		Character	'1'	'\$00'	<input type="checkbox"/>	
26	"IO-Link Record"."RECORD_IOL_DATA_SE..."		Character	'1'	'\$00'	<input type="checkbox"/>	
27	"IO-Link Record"."RECORD_IOL_DATA_SE..."		Character	'6'	'\$00'	<input type="checkbox"/>	
28	"IO-Link Record"."RECORD_IOL_DATA_SE..."		Character	'D'	'\$00'	<input type="checkbox"/>	
29	"IO-Link Record"."RECORD_IOL_DATA_SE..."		Character	'X'	'\$00'	<input type="checkbox"/>	
30	"IO-Link Record"."RECORD_IOL_DATA_SE..."		Character	'P'	'\$00'	<input type="checkbox"/>	
31	"IO-Link Record"."RECORD_IOL_DATA_SE..."		Character		'\$00'	<input type="checkbox"/>	
32	"IO-Link Record"."RECORD_IOL_DATA_SE..."		Character	16#00	'\$00'	<input type="checkbox"/>	
33	"IO-Link Record"."RECORD_IOL_DATA_SE..."		Hex	16#00		<input type="checkbox"/>	

Fig. 44: IO_LINK_DEVICE – product name TBIL-M1-16DXP

Example access write – rotate display

The display of the Turck temperature sensors TS-500-LUUPN8X-H1141-... at IO-Link port 1 is rotated. The parameter **Measured value update time/rotating/disabling a display** in index 55 is set to 0x05 = 600 ms measured value update time, display rotated by 180°.

Temperature sensors TS series IO-Link Parameters

Specific On-Request Data Objects – Parameter values

Index 0x54; Displayed unit

Value (hexadezcimal)	Menu item	Function
0x00	°C	°C
0x01	°F	°F
0x02	k	k
0x03	Ohm	Ohm

Index 0x55: Measured value update time/rotating/disabling a display

Value (hexadecimal)	Menu item	Function
0x00	50	50 ms measured value update time
0x01	200	200 ms measured value update time
0x02	600	600 ms measured value update time
0x03	r50	50 ms measured value update time, display rotated by 180°
0x04	r200	200 ms measured value update time, display rotated by 180°
0x05	r600	600 ms measured value update time, display rotated by 180°
0x06	OFF	Display disabled

Index 0x56: Behaviour of output 1 in the event of error

Value (hexadecimal)	Menu item	Function
0x00	Fou1	Output off
0x01	Fou2	Output on

Fig. 45: Extract from the documentation for TS-500-...

- ▶ Write the input variables of the function block via **control variable** as follows:
- ▶ Activate the write access in the function block via **RD_WR Sensor 1= TRUE**.

Variable	Value	Meaning
REQ	TRUE	Send a write request
ID	264	Hardware identifier of the Basic slot according to the configuration in the Device view
CAP	251	Function block instance
LEN	1	Length of the data to be written in byte
PORT	1	The temperature sensor TS-500-LUUPN8X-H1141 is connected to port 1.
IOL_INDEX	0x12	Index for Measured value update time/rotating/disabling a display

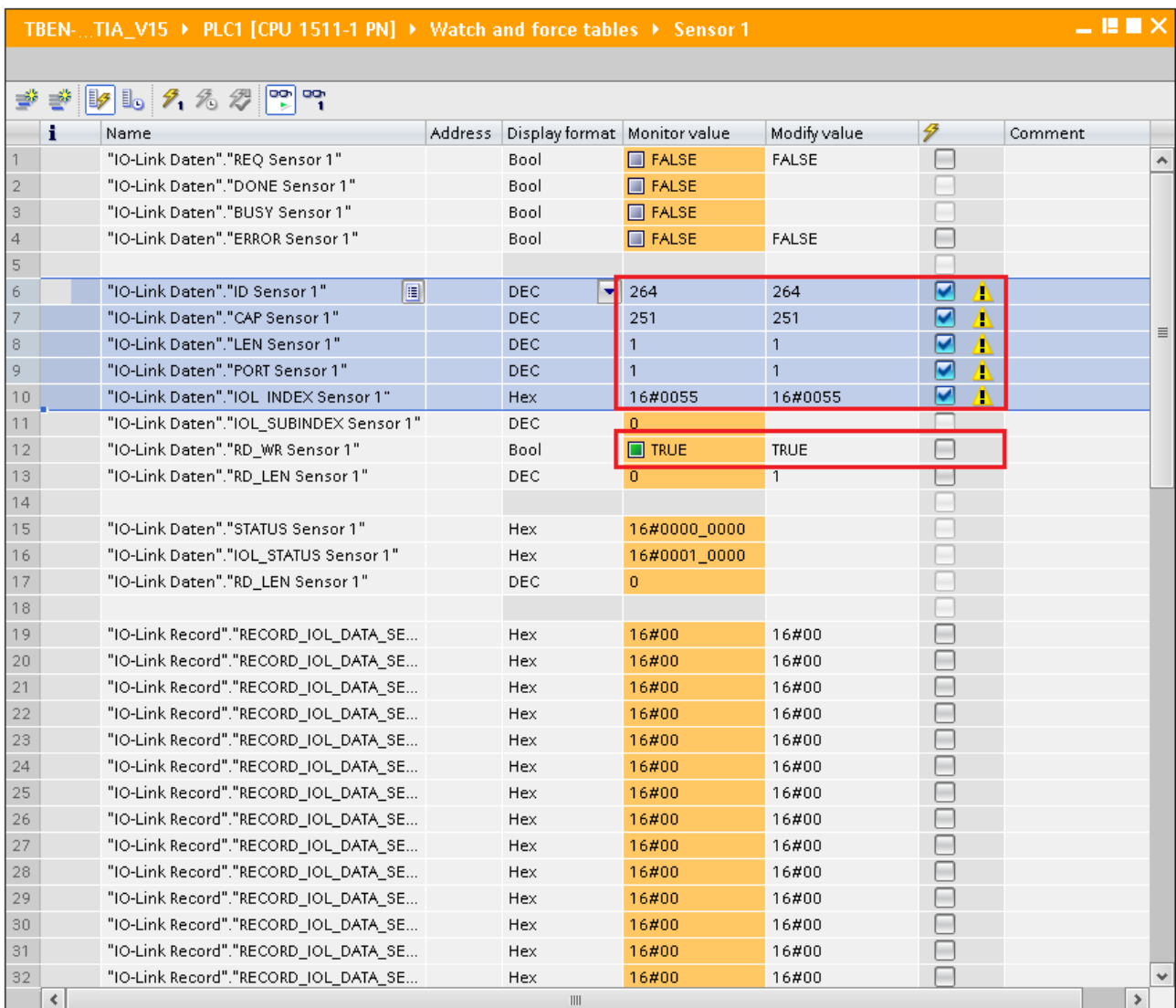

Fig. 46: IO_LINK_DEVICE – input variables for read access

- ▶ Set the value to be written **0x05** via the first word of **IO-Link Record** in the watch table.

	Name	Address	Display format	Monitor value	Modify value		Comment
1	"IO-Link Daten"."REQ Sensor 1"		Bool	<input type="checkbox"/> FALSE	FALSE	<input type="checkbox"/>	0 -> 1 start CALL
2	"IO-Link Daten"."DONE Sensor 1"		Bool	<input type="checkbox"/> FALSE		<input type="checkbox"/>	
3	"IO-Link Daten"."BUSY Sensor 1"		Bool	<input type="checkbox"/> FALSE		<input type="checkbox"/>	
4	"IO-Link Daten"."ERROR Sensor 1"		Bool	<input type="checkbox"/> FALSE	FALSE	<input type="checkbox"/>	
5						<input type="checkbox"/>	
6	"IO-Link Daten"."ID Sensor 1"		DEC	264	264	<input type="checkbox"/>	
7	"IO-Link Daten"."CAP Sensor 1"		DEC	251	251	<input type="checkbox"/>	
8	"IO-Link Daten"."LEN Sensor 1"		DEC	1	1	<input type="checkbox"/>	
9	"IO-Link Daten"."PORT Sensor 1"		DEC	1	1	<input type="checkbox"/>	
10	"IO-Link Daten"."IOL_INDEX Sensor 1"		Hex	16#0055	16#0055	<input type="checkbox"/>	
11	"IO-Link Daten"."IOL_SUBINDEX Sensor 1"		DEC	0		<input type="checkbox"/>	
12	"IO-Link Daten"."RD_WR Sensor 1"		Bool	<input checked="" type="checkbox"/> TRUE	TRUE	<input type="checkbox"/>	
13	"IO-Link Daten"."RD_LEN Sensor 1"		DEC	0	1	<input type="checkbox"/>	
14						<input type="checkbox"/>	
15	"IO-Link Daten"."STATUS Sensor 1"		Hex	16#0000_0000		<input type="checkbox"/>	
16	"IO-Link Daten"."IOL_STATUS Sensor 1"		Hex	16#0001_0000		<input type="checkbox"/>	
17	"IO-Link Daten"."RD_LEN Sensor 1"		DEC	0		<input type="checkbox"/>	
18						<input type="checkbox"/>	
19	"IO-Link Record"."RECORD_IOL_DATA_SE...		Hex	16#05	16#05	<input checked="" type="checkbox"/> ⚠	
20	"IO-Link Record"."RECORD_IOL_DATA_SE...		Hex	16#00	16#00	<input type="checkbox"/>	
21	"IO-Link Record"."RECORD_IOL_DATA_SE...		Hex	16#00	16#00	<input type="checkbox"/>	
22	"IO-Link Record"."RECORD_IOL_DATA_SE...		Hex	16#00	16#00	<input type="checkbox"/>	
23	"IO-Link Record"."RECORD_IOL_DATA_SE...		Hex	16#00	16#00	<input type="checkbox"/>	
24	"IO-Link Record"."RECORD_IOL_DATA_SE...		Hex	16#00	16#00	<input type="checkbox"/>	
25	"IO-Link Record"."RECORD_IOL_DATA_SE...		Hex	16#00	16#00	<input type="checkbox"/>	
26	"IO-Link Record"."RECORD_IOL_DATA_SE...		Hex	16#00	16#00	<input type="checkbox"/>	
27	"IO-Link Record"."RECORD_IOL_DATA_SE...		Hex	16#00	16#00	<input type="checkbox"/>	
28	"IO-Link Record"."RECORD_IOL_DATA_SE...		Hex	16#00	16#00	<input type="checkbox"/>	
29	"IO-Link Record"."RECORD_IOL_DATA_SE...		Hex	16#00	16#00	<input type="checkbox"/>	
30	"IO-Link Record"."RECORD_IOL_DATA_SE...		Hex	16#00	16#00	<input type="checkbox"/>	
31	"IO-Link Record"."RECORD_IOL_DATA_SE...		Hex	16#00	16#00	<input type="checkbox"/>	
32	"IO-Link Record"."RECORD_IOL_DATA_SE...		Hex	16#00	16#00	<input type="checkbox"/>	

Fig. 47: IO_LINK_DEVICE – Control value 0x05 for index 0x55

- ▶ Activate the Write access via a rising edge at **REQ**.

	Name	Address	Display format	Monitor value	Modify value		Comment
1	"IO-Link Daten"."REQ Sensor 1"		Bool	<input checked="" type="checkbox"/> TRUE	TRUE	<input checked="" type="checkbox"/> ⚠	0 -> 1 start CALL
2	"IO-Link Daten"."DONE Sensor 1"		Bool	<input checked="" type="checkbox"/> TRUE		<input type="checkbox"/>	
3	"IO-Link Daten"."BUSY Sensor 1"		Bool	<input type="checkbox"/> FALSE		<input type="checkbox"/>	
4	"IO-Link Daten"."ERROR Sensor 1"		Bool	<input type="checkbox"/> FALSE	FALSE	<input type="checkbox"/>	
5						<input type="checkbox"/>	
6	"IO-Link Daten"."ID Sensor 1"		DEC	264	264	<input type="checkbox"/>	
7	"IO-Link Daten"."CAP Sensor 1"		DEC	251	251	<input type="checkbox"/>	

Fig. 48: IO_LINK_DEVICE – activate read access

- ⇒ The display is now rotated about 180° and set to an actualization time of 600 ms

8.8 Commissioning the device in Modbus TCP

8.8.1 Implemented Modbus functions

The devices support the following functions for accessing process data, parameters, diagnostics and other services.

Function Code	
1	Read Coils – reading multiple output bits
2	Read Discrete Inputs – reading multiple input bits
3	Read Holding Registers – reading multiple output registers
4	Read Input Registers – reading multiple input registers
5	Write Single Coil – writing single output bit
6	Write Single Register – writing single output register
15	Write Multiple Coils – writing multiple output bits
16	Write Multiple Registers – writing multiple output
23	Read/Write Multiple Registers – reading and writing multiple registers

8.8.2 Modbus registers

Address	Access	Meaning
0x0000...0x01FF	read only	Process data of the inputs (identical to registers 0x8000...0x8FFF)
0x0800...0x09FF	read/write	Process data of the outputs (identical to registers 0x9000...0x9FFF)
0x1000...0x100B	read only	Module identifier
0x100C	read only	Module status
0x1017	read only	Register mapping revision (always 2, if not, mapping is incompatible with this description)
0x1020	read only	Watchdog, actual time [ms]
0x1120	read/write	Watchdog predefined time [ms] (default: 500 ms)
0x1130	read/write	Modbus connection mode register
0x1131	read/write	Modbus Connection Timeout in sec. (def.: 0 = never)
0x113C...0x113D	read/write	Modbus Parameter Restore (reset of parameters to default values)
0x113E...0x113F	read/write	Modbus Parameter Save (permanent storing of parameters)
0x1140	read/write	Deactivate protocol Deactivates explicitly the selected Ethernet protocol: <ul style="list-style-type: none"> ■ Bit 0 = deactivate EtherNet/IP ■ Bit 1 = deactivate Modbus TCP ■ Bit 2 = deactivate PROFINET ■ Bit 15 = deactivate web server
0x1141	read/write	Active protocol <ul style="list-style-type: none"> ■ Bit 0 = EtherNet/IP active ■ Bit 1 = Modbus TCP active ■ Bit 2 = PROFINET active ■ Bit 15 = Web server active

Address	Access	Meaning
0x1150	read only	LED behavior (PWR) at V2 undervoltage bit 0: 0 = red 1 = green flashing
0x2400	read only	V1 [mV]: 0 at < 18 V
0x2401	read only	V2 [mV]: 0 at < 18 V
0x8000...0x8400	read only	Process data of the inputs (identical to registers 0x0000...0x01FF)
0x9000...0x9400	read/write	Process data of the outputs (identical to registers 0x0800...0x09FF)
0xA000...0xA400F	read only	Diagnostics
0xB000...0xB400	read/write	Parameters

The following table shows the register mapping for the different Modbus addressing methods:

Description	Hex	decimal	5-digit	Modicon
Inputs	0x0000...0x01FF	0...511	40001...40512	400001...400512
Outputs	0x0800...0x09FF	2048...2549	42049...42560	402049...402560
Module identifier	0x1000...0x1006	4096...4102	44097...44103	404097...404103
Module status	0x100C	4108	44109	404109
Watchdog, actual time	0x1020	4128	44129	404129
Watchdog, predefined time	0x1120	4384	44385	404385
Modbus connection mode re- gister	0x1130	4400	44401	404401
Modbus Connection Timeout in sec.	0x1131	4401	44402	404402
Modbus Parameter Restore	0x113C...0x113D	4412...4413	44413...44414	404413...404414
Modbus Parameter Save	0x113E...0x113F	4414...4415	44415...44416	404415...404416
Deactivate protocol	0x1140	4416	44417	404417
Active protocol	0x1141	4417	44418	404418
LED behavior (PWR) at V2 under- voltage	0x1150	4432	44433	404433
V1 [mV]:	0x2400	9216	49217	409217
V2 [mV]:	0x2401	9217	49218	409218
Process data inputs	0x8000, 0x8001	32768, 32769	-	432769, 432770
Process data outputs	0x9000, 0x9001	36864, 36865	-	436865, 436866
Diagnostics	0xA000, 0xA001	40960, 40961	-	440961, 440962
Parameters	0xB000, 0xB001	45056, 45057	-	445057, 445058

Register 0x1130: Modbus connection mode

This register defines the behavior of the Modbus connections.

Bit	Designation	Value	Meaning
0	MB_OnlyOneWritePermis- sion	0	All Modbus connections receive the write au- thorization
		1	Only one Modbus connection can receive the write permission. A write permission is opened until a Disconnect. After the Disconnect the next connection which requests a write access receives the write authorization.
1	MB_ImmediateWritePer- mission	0	With the first write access, a write authoriza- tion for the respective Modbus connection is requested. If this request fails, an exception re- sponse with exception-code 0x01 is gener- ated. If the request is accepted, the write ac- cess is executed and the write authorization remains active until the connection is closed.
		1	The write authorization for the respective Modbus connection is already opened during the connection establishment. The first Mod- bus connection thus receives the write author- ization, all following connections don't (only if bit 0 = 1).
2...15	reserved	-	-

Register 0x1131: Modbus connection timeout

This register defines after which time of inactivity a Modbus connection is closed through a Disconnect.

Value range: 0...65535 s

default: 0 s = never (Modbus connection will never be closed)

Behavior of the BUS LED

If Modbus is the active protocol in case of a connection Time out and no further Modbus connections exist, the BUS LED behaves as follows:

Connection timeout	BUS LED
timeout	Green blinking

Register 0x113C and 0x113D: Restore Modbus-Connection-Parameters

Registers 0x113C and 0x113D serve for resetting the parameter-register 0x1120 and 0x1130 to 0x113B to the default settings. The service resets the parameters without saving them.

Procedure:

- ▶ Write 0x6C6F to register 0x113C.
- ▶ To activate the reset of the registers, write 0x6164 ("load") within 30 seconds in register 0x113D. Both registers can also be written with one single request using the function codes FC16 and FC23.
- ⇒ The parameters are reset tot default values.
- ▶ Save changes via a subsequent Save service.

Register 0x113E and 0x113F: Save Modbus-Connection-Parameters

Registers 0x113E and 0x113F are used for the non-volatile saving of parameters in registers 0x1120 and 0x1130 to 0x113B.

Procedure:

- ▶ Write 0x7361 to register 0x113E.
- ▶ Write 0x7665 ("save") within 30 seconds in register 0x113F to activate the reset of the registers. Both registers can also be written with one single request using the function codes FC16 and FC23.
- ⇒ The parameters are saved.

8.8.3 Data width

Module	Process input data	Process output data	Alignment
TBEN-L...-8IOL	344 byte	260	word by word

8.8.4 Register mapping

Register no.	Bit no.																
	15	14	13	12	11	10	9	8	7	6	5	4	3	2	1	0	
	MSB								LSB								
	Input data																
0x0000... 0x00xx	Process input data ▶ 127]																
	Module status																
0x00xx + 1 register	see status- and control word ▶ 132]																
	Output data																
0x0800... 0x08xx	Process output data ▶ 129]																
	Diagnostics ▶ 131]																
0xA000	DXP channel diagnostics																
0xA001	IO-Link channel diagnosis																
...																	
0xA004																	
	Parameters																
	IO-Link Basic																
0xB000	-	-	-	-	-	-	-	-	-	DXP7_ SRO	-	DXP5_ SRO	-	DXP3_ SRO	-	DXP1_ SRO	
0xB001	-	-	-	-	-	-	-	-	-	DXP7_ EN DO	-	DXP5_ EN DO	-	DXP3_ EN DO	-	DXP1_ EN DO	
	IO-Link port 1																
0xB002	Cycle time								GSD	Activate Quick Start-Up	Data storage mode	Mode					
0xB003	-	-	-	-	-	-	-	-	-	Mapping PCDO	Mapping PDIN	Deactivate diag.	PDIN invalid	Rev.			
0xB004... 0xB005	-	-	-	-	-	-	-	-	-	-	-	-	-	-	-	-	
0xB006	Vendor ID																
0xB007 ... 0xB008	Device ID																
0xB009	-	-	-	-	-	-	-	-	-	-	-	-	-	-	-	-	
	IO-Link port 2																
0xB00A... 0xB011	8 registers parameter data, assignment similar to port 1																
	IO-Link port 3																
0xB012... 0xB019	8 registers parameter data, assignment similar to port 1																
	IO-Link port 4																
0xB01A... 0xB021	8 registers parameter data, assignment similar to port 1																

Register no.	Bit no.															
	15	14	13	12	11	10	9	8	7	6	5	4	3	2	1	0
	IO-Link port 5															
0xB022... 0xB029	8 registers parameter data, assignment similar to port 1															
	IO-Link port 6															
0xB02A... 0xB031	8 registers parameter data, assignment similar to port 1															
	IO-Link port 7															
0xB032... 0xB039	8 registers parameter data, assignment similar to port 1															
	IO-Link port 8															
0xB30A... 0xB041	8 registers parameter data, assignment similar to port 1															
	VAUX1 monitoring															
0xB042	-	-	-	-	-	-	VAUX1 pin1 X1 (ch2/3)	-	-	-	-	-	-	-	-	VAUX1 pin1 X0 (ch0/1)
0xB043	-	-	-	-	-	-	VAUX1 pin1 X3 (ch6/7)	-	-	-	-	-	-	-	-	VAUX1 pin1 X2 (ch4/5)
0xB044	-	-	-	-	-	-	VAUX1 pin1 X5 (ch10)	-	-	-	-	-	-	-	-	VAUX1 pin1 X4 (ch8)
0xB045	-	-	-	-	-	-	VAUX1 pin1 X7 (ch14)	-	-	-	-	-	-	-	-	VAUX1 pin1 X6 (ch12)
0xB046... 0xB047	-	-	-	-	-	-	-	-	-	-	-	-	-	-	-	-
	VAUX1 monitoring															
0xB048	-	-	-	-	-	-	VAUX2 pin2 X5 (ch11)	-	-	-	-	-	-	-	-	VAUX2 pin2 X4 (ch9)
0xB049	-	-	-	-	-	-	VAUX2 pin2 X7 (ch15)	-	-	-	-	-	-	-	-	VAUX2 pin2 X6 (ch13)

8.8.5 Error Behavior (watchdog)

Behavior of outputs

In case of a failure of the Modbus communication, the outputs' behavior is as follows, depending on the defined time for the Watchdog (register 0x1120):

Watchdog	Behavior of outputs
0 ms	All outputs maintain the actual value in case of an error
> 0 ms (default = 500 ms)	Outputs switch to 0 after the watchdog time has expired (setting in register 0x1120).



NOTE

Setting the outputs to predefined substitute values is not possible in Modbus TCP. Eventually parameterized substitute values will not be used.

Behavior of the BUS LED

If the watchdog triggers, the BUS LED behaves as follows:

Watchdog	BUS LED
Tripped	Red

Behavior of the device in case of loss of Modbus communication

If Modbus is the active protocol and all Modbus connections are closed, the watchdog switches all outputs to "0" after the watchdog time has expired, unless another protocol (PROFINET, EtherNet/IP) has been activated in the meantime.

8.9 Commissioning the Device in EtherNet/IP

8.9.1 Common EtherNet/IP features

Features	Description
QuickConnect	No
Device Level Ring (DLR)	yes
Number of TCP connections	3
Number of CIP connections	10
Input assembly instance	103, 120, 121, 122, 123, 124, 125
Output assembly instance	104, 150, 151, 152
Configuration assembly Instance	106

8.9.2 EDS files and catalog files

The EDS and catalog files can be downloaded free of charge from www.turck.com.

- TBEN-L_ETHERNETIP.zip

8.9.3 Device Level Ring (DLR)

The devices support DLR. The Device Level Ring (DLR)-redundancy protocol is used to increase the stability of EtherNet/IP networks. DLR-enabled devices have an integrated switch and can thus be integrated into a ring topology. The DLR protocol is used to detect an interruption in the ring. If the data line is interrupted, data are sent through an alternative network section, so that the network can be reconfigured as soon as possible. DLR-capable network nodes are provided with extended diagnostic functions which enable the devices to localize errors and thus decrease the time for error search and maintenance.

8.9.4 Diagnostic messages via process data

The diagnostic messages of the IO-Link channels are directly mapped into the process data [▶ 127].

Additionally, the device's status word contains the module diagnostics:

Byte 1 (MSB)								Byte 0 (LSB)							
Bit 15	Bit 14	Bit 13	Bit 12	Bit 11	Bit 10	Bit 9	Bit 8	Bit 7	Bit 6	Bit 5	Bit 4	Bit 3	Bit 2	Bit 1	Bit 0
-	FCE	-	-	-	-	V1	-	V2	-	-	-	-	-	AR-GEE	DIAG

8.9.5 EtherNet/IP standard classes

The modules support the following EtherNet/IP Standard Classes in accordance with the CIP specification.

Class Code		Object name
Dec.	Hex.	
01	0x01	Identity Object [▶ 72]
04	0x04	Assembly Object [▶ 74]
06	0x06	Connection Manager Object [▶ 87]
245	0xF5	TCP/IP Interface Object [▶ 88]
246	0xF6	Ethernet Link Object [▶ 91]

Identity Object (0x01)

The following description of the Ethernet Link Object is taken from the CIP specification, Vol. 2, Rev. 2.1 by ODVA & ControlNet International Ltd. and adapted to the Turck products.

Instance attributes

Attr. no.		Attribute name	Get/set	Type	Value
Dec.	Hex.				
1	0x01	Vendor ID	G	UINT	Contains the manufacturer ID. Turck = 0x46
2	0x02	Product type	G	UINT	Shows the general product type. Communications Adapter 12 _{dez} = 0x0C
3	0x03	Product code	G	UINT	Identifies a special product in a device type. default: 27247 _{dec} = 6A6F
4	0x04	Revision	G	STRUCT OF: <ul style="list-style-type: none"> ■ Major ■ Minor 	Revision of the device which is represented by the Identity Object. <ul style="list-style-type: none"> ■ 0x01 ■ 0x06
5	0x05	Device status	G	WORD	WORD
6	0x06	Serial number	G	UDINT	Contains the identification number of the product (the last 3 bytes of the MAC-ID).
7	0x07	Product name	G	STRUCT OF: USINT STRING [13]	i.e.: TBEN-S2-4IOL

Device Status

Bit	Name	Definition
0...1	reserved	default = 0
2	Configured	TRUE = 1: The application in the device has been configured (default setting).
3	reserved	default = 0

Bit	Name	Definition
4...7	Extended Device Status	0011 = no I/O connection established 0110 = at least one I/O connection in RUN mode 0111 = at least one I/O connection established, all in IDLE mode All other settings = reserved
8	Minor recoverable fault	Recoverable fault, e.g.: <ul style="list-style-type: none"> ■ Undervoltage ■ Force-Mode in DTM active ■ Diagnostic active at I/O channel
9...10	reserved	
11	Diag	Common error bit
12...15	reserved	default = 0

Common services

Service code		Class	Instance	Service name
Dec.	Hex.			
1	0x01	Yes	Yes	Get_Attribute_All returns a predefined list of object attributes
5	0x05	No	Yes	reset starts the reset service for the device
14	0x0E	Yes	Yes	Get_Attribute_Single returns the content of a specified attribute
16	0x10	No	No	Set_Attribute_Single changes a single attribute

Assembly Object (0x04)

The Assembly Object combines attributes of several objects and allows data to be sent from one object to another or to receive data in a targeted manner

The following description of the Ethernet Link Object is taken from the CIP specification, Vol. 2, Rev. 2.1 by ODVA & ControlNet International Ltd. and adapted to the Turck products.

Instance attributes

Attr. no.	Attribute name	Get/set	Type	Value	
Dec.	Hex.				
3	0x03	Data	S	ARRAY OF BYTE	Identifies a special product in a device type. default: 27247 _{dec} = 6A6F
4	0x04	Size	G	UINT	Number of bytes in attribute 3: 256 or variable

Common services

Service code	Class	Instance	Service name	
Dec.	Hex.			
14	0x0E	Yes	Yes	Get_Attribute_Single Returns the content of a specified attribute.

Assembly instances

EtherNet/IP connection	Input Assembly		Output Assembly		Configuration Assembly		Supported by	
	Instance	Size [8 bit]	Instance	Size [8 bit]	Instance	Size [8 bit]	Rockwell	Omron
Exclusive Owner	103	346	104	262	106	160	x	-
Input Only	103	346	254	0	1	0	x	-
Exclusive Owner (Omron)	103	346	104	262	1	0	x	-
IOL 4 IN/4 OUT, diagnostics	120	58	150	38	106	160	x	x
IOL 6 IN/6 OUT, diagnostics	122	74	151	54	106	160	x	x
IOL 8 IN/8 OUT, diagnostics	124	90	152	70	106	160	x	x
IOL 4 IN/4 OUT	121	38	150	38	106	160	x	x
IOL 6 IN/6 OUT	123	54	151	54	106	160	x	x
IOL 8 IN/8 OUT	125	70	152	70	106	160	x	x

Configuration assembly (instance 106)

The modules support Configuration Assembly.

The Configuration Assembly contains:

10 bytes module configuration data (EtherNet/IP-specific)

+ 136 bytes (parameter data, depending on device)

The meaning of the input data can be found in chapter "Parameterizing and configuring".

Byte no.		Bit no.							
Dec.	Hex.	7	6	5	4	3	2	1	0
Device Configuration Data									
0...8	0x00... 0x08	-	-	-	-	-	-	-	-
9	0x09	-	-	-	-	LED behavior (PWR) at V2 undervoltage	Eth2 port setup	Eth1 port setup	QuickConnect (not supported)
DXP channels									
10	0x0A	-	-	-	-	-	-	-	DXP1_SRO
11	0x0B	-	-	-	-	-	-	-	DXP3_SRO
12	0x0C	-	-	-	-	-	-	-	DXP5_SRO
13	0x0D	-	-	-	-	-	-	-	DXP7_SRO
14	0x0E	-	-	-	-	-	-	-	DXP1_EN DO
15	0x0F	-	-	-	-	-	-	-	DXP3_EN DO
16	0x10	-	-	-	-	-	-	-	DXP5_EN DO
17	0x11	-	-	-	-	-	-	-	DXP7_EN DO
IO-Link port parameters									
		IO-Link port 1							
18	0x12	-	-	-	-	Operation mode			
19	0x13	-	-	-	-	-	-	Data Storage Mode	
20	0x14	Cycle time							
21	0x15	-	-	-	-	-	-	-	Revision
22	0x16	-	-	-	-	-	-	-	Quick Start-Up
23	0x17	-	-	-	-	-	-	-	GSD
24	0x18	-	-	-	-	-	-	-	PCDI invalid
25	0x19	-	-	-	-	-	-	-	Deactivate diagnostics
26	0x1A	-	-	-	-	-	-	Mapping PDIN	
27	0x1B	-	-	-	-	-	-	Mapping PDOOUT	
28...29	0x1C... 0x1D	Vendor ID							
30...33	0x1E... 0x21	Device ID							
34...49	0x22... 0x31	IO-Link port 2							
50...65	0x32... 0x41	IO-Link port 3							

Byte no.		Bit no.							
Dec.	Hex.	7	6	5	4	3	2	1	0
66...81	0x42... 0x51	IO-Link port 4							
82...97	0x52... 0x61	IO-Link port 5							
98...113	0x62... 0x71	IO-Link port 6							
114...129	0x72... 0x81	IO-Link port 7							
130...145	0x82... 0x91	IO-Link port 8							
146	0x92	-	-	-	-	-	-	-	VAUX1 pin1 C0 (ch0/1)
147	0x93	-	-	-	-	-	-	-	VAUX1 pin1 C1 (ch2/3)
148	0x94	-	-	-	-	-	-	-	VAUX1 pin1 C2 (ch4/5)
149	0x95	-	-	-	-	-	-	-	VAUX1 pin1 C3 (ch6/7)
150	0x96	-	-	-	-	-	-	-	VAUX1 pin1 C4 (ch8)
151	0x97	-	-	-	-	-	-	-	VAUX2 pin2 C4 (ch9)
152	0x98	-	-	-	-	-	-	-	VAUX1 pin1 C5 (ch10)
153	0x99	-	-	-	-	-	-	-	VAUX2 pin2 C5 (ch11)
154	0x9A	-	-	-	-	-	-	-	VAUX1 pin1 C6 (ch12)
155	0x9B	-	-	-	-	-	-	-	VAUX2 pin2 C6 (ch13)
156	0x9C	-	-	-	-	-	-	-	VAUX1 pin1 C7 (ch14)
157	0x9D	-	-	-	-	-	-	-	VAUX2 pin2 C7 (ch15)

Device configuration data

Parameter name	Value	Meaning
LED-behavior (PWR) at V2 undervoltage	0	Red
	1	green
ETH x Port Setup	0	Auto negotiation
	1	100BT/FD

Input assembly instances

EtherNet/IP Con- nection	Input Assembly		Device status [byte]	Basic I/O [byte]	IO-Link inputs [byte]	Diagnostics [byte]	Event data (byte)
	Instance	Size [8 bit]					
Exclusive Owner	103	346	2	4	256	20	64
Input Only	103	346	2	4	256	20	64
Exclusive Owner (Omron)	103	346	2	4	256	20	64
IOL 4 IN/4 OUT, diagnostics	120	58	2	4	32	20	0
IOL 6 IN/6 OUT, diagnostics	122	74	2	4	48	20	0
IOL 8 IN/8 OUT, diagnostics	124	90	2	4	64	20	0
IOL 4 IN/4 OUT	121	38	2	4	32	0	0
IOL 6 IN/6 OUT	123	54	2	4	48	0	0
IOL 8 IN/8 OUT	125	70	2	4	64	0	0

Instance 103 – Exclusive Owner

The description of the input data can be found in chapter “Operating” [▶ 127]

Word no.	Bit no.															
	15	14	13	12	11	10	9	8	7	6	5	4	3	2	1	0
Status word																
0x00	-	FCE	-	-	-	-	V1	-	V2	-	-	-	-	-	-	DIAG
Inputs																
0x01	-	DI14 (SIO)	-	DI12 (SIO)	-	DI10 (SIO)	-	DI8 (SIO)	DXP7	DI6 (SIO)	DXP5	DI4 (SIO)	DXP3	DI2 (SIO)	DXP1	DI0 (SIO)
Process input data valid																
0x02	-	DVS 14	-	DVS 12	-	DVS 10	-	DVS8	-	DVS6	-	DVS4	-	DVS2	-	DVS0
IO-Link process input data																
0x03... 0x12	16 words per port															
...																
0x73... 0x82																
Diagnostics																
VAUX1/VAUX2																
0x83	VERR V2 X7 ch15	VERR V2 X6 ch13	VERR V2 X5 ch11	VERR V2 X4 ch9	-	-	-	-	VERR V1 X7 ch14	VERR V1 X6 ch12	VERR V1 X5 ch10	VERR V1 X4 ch08	VERR V1 X3 ch6/7	VERR V1 X2 ch4/5	VERR V1 X1 ch2/3	VERR V1 X0 ch0/1
DXP channels																
0x84	-	-	-	-	-	-	-	-	ERR DXP 7	-	ERR DXP 5	-	ERR DXP 3	-	ERR DXP 1	-
IO-Link port diagnostics																
Port 1																
0x85	GEN ERR	OVL	V HIGH	V LOW	UL VE	LL VU	O TMP	PRM ERR	EVT1	EVT2	PD INV	HW ERR	DS ERR	CFG ERR	PPR	-
...																
Port 8																
0x8C	GEN ERR	OVL	V HIGH	V LOW	UL VE	LLVU	O TMP	PRM ERR	EVT1	EVT2	PD INV	HW ERR	DS ERR	CFG ERR	PPR	-
IO-Link Events																
0x8D	Port (1st Event)								Qualifier (1st Event)							
0x8E	Event Code low byte (1st Event)								Event Code high byte (1st Event)							
...																
0xAB	Port 16th Event)								Qualifier (16th Event)							
0xAC	Event Code low byte (16th Event)								Event Code high byte (16th Event)							

Instance 120 – 4 byte IN/4 byte OUT, diagnostics

The description of the input data can be found in chapter “Operating” [▶ 127]

Word no.	Bit no.															
	15	14	13	12	11	10	9	8	7	6	5	4	3	2	1	0
Status word																
0x00	-	FCE	-	-	-	-	V1	-	V2	-	-	-	-	-	-	Diag
Inputs																
0x01	-	DI14 (SIO)	-	DI12 (SIO)	-	DI10 (SIO)	-	DI8 (SIO)	DXP7	DI6 (SIO)	DXP5	DI4 (SIO)	DXP3	DI2 (SIO)	DXP1	DI0 (SIO)
Process input data valid																
0x02	-	DVS 14	-	DVS 12	-	DVS 10	-	DVS8	-	DVS6	-	DVS4	-	DVS2	-	DVS0
IO-Link process input data																
0x03... 0x04 ... 0x11... 0x12	2 words per port															
Diagnostics																
VAUX1/VAUX2																
0x13	VERR V2 X7 ch15	VERR V2 X6 ch13	VERR V2 X5 ch11	VERR V2 X4 ch9	-	-	-	-	VERR V1 X7 ch14	VERR V1 X6 ch12	VERR V1 X5 ch10	VERR V1 X4 ch08	VERR V1 X3 ch6/7	VERR V1 X2 ch4/5	VERR V1 X1 ch2/3	VERR V1 X0 ch0/1
DXP channels																
0x14	-	-	-	-	-	-	-	-	ERR DXP 7	-	ERR DXP 5	-	ERR DXP 3	-	ERR DXP 1	-
IO-Link port diagnostics																
Port 1																
0x15	GEN ERR	OVL	V HIGH	V LOW	UL VE	LL VU	O TMP	PRM ERR	EVT1	EVT2	PD INV	HW ERR	DS ERR	CFG ERR	PPR	-
...																
Port 8																
0x1C	GEN ERR	OVL	V HIGH	V LOW	UL VE	LL VU	O TMP	PRM ERR	EVT1	EVT2	PD INV	HW ERR	DS ERR	CFG ERR	PPR	-

Instance 121 – 4 byte IN/4 byte OUT

The description of the input data can be found in chapter “Operating” [▶ 127]

Word no.	Bit no.															
	15	14	13	12	11	10	9	8	7	6	5	4	3	2	1	0
Status word																
0x00	-	FCE	-	-	-	-	V1	-	V2	-	-	-	-	-	-	Diag
Inputs																
0x01	-	DI14 (SIO)	-	DI12 (SIO)	-	DI10 (SIO)	-	DI8 (SIO)	DXP7	DI6 (SIO)	DXP5	DI4 (SIO)	DXP3	DI2 (SIO)	DXP1	DI0 (SIO)
Process input data valid																
0x02	-	DVS 14	-	DVS 12	-	DVS 10	-	DVS8	-	DVS6	-	DVS4	-	DVS2	-	DVS0
IO-Link process input data																
0x03...	2 words per port															
0x04																
...																
0x11...																
0x12																

Instance 122 – 6 byte IN/6 byte OUT, diagnostics

The description of the input data can be found in chapter “Operating” [▶ 127]

Word no.	Bit no.															
	15	14	13	12	11	10	9	8	7	6	5	4	3	2	1	0
Status word																
0x00	-	FCE	-	-	-	-	V1	-	V2	-	-	-	-	-	-	Diag
Inputs																
0x01	-	DI14 (SIO)	-	DI12 (SIO)	-	DI10 (SIO)	-	DI8 (SIO)	DXP7	DI6 (SIO)	DXP5	DI4 (SIO)	DXP3	DI2 (SIO)	DXP1	DI0 (SIO)
Process input data valid																
0x02	-	DVS 14	-	DVS 12	-	DVS 10	-	DVS8	-	DVS6	-	DVS4	-	DVS2	-	DVS0
IO-Link process input data																
0x03... 0x05	3 words per port															
0x06... 0x08																
0x09... 0x0B																
0x0C... 0x0E																
0x0F... 0x11																
0x12... 0x14																
0x15... 0x17																
0x18... 0x1A																
Diagnostics																
VAUX1/VAUX2																
0x1B	VERR V2 X7 ch15	VERR V2 X6 ch13	VERR V2 X5 ch11	VERR V2 X4 ch9	-	-	-	-	VERR V1 X7 ch14	VERR V1 X6 ch12	VERR V1 X5 ch10	VERR V1 X4 ch08	VERR V1 X3 ch6/7	VERR V1 X2 ch4/5	VERR V1 X1 ch2/3	VERR V1 X0 ch0/1
DXP channels																
0x1C	-	-	-	-	-	-	-	-	ERR DXP 7	-	ERR DXP 5	-	ERR DXP 3	-	ERR DXP 1	-
IO-Link port diagnostics																
Port 1																
0x1D	GEN ERR	OVL	V HIGH	V LOW	UL VE	LL VU	O TMP	PRM ERR	EVT1	EVT2	PD INV	HW ERR	DS ERR	CFG ERR	PPR	-
...																
Port 8																
0x24	GEN ERR	OVL	V HIGH	V LOW	UL VE	LL VU	O TMP	PRM ERR	EVT1	EVT2	PD INV	HW ERR	DS ERR	CFG ERR	PPR	-

Instance 123 – 6 byte IN/6 byte OUT

The description of the input data can be found in chapter “Operating” [▶ 127]

Word no.	Bit no.															
	15	14	13	12	11	10	9	8	7	6	5	4	3	2	1	0
Status word																
0x00	-	FCE	-	-	-	-	V1	-	V2	-	-	-	-	-	-	Diag
Inputs																
0x01	-	DI14 (SIO)	-	DI12 (SIO)	-	DI10 (SIO)	-	DI8 (SIO)	DXP7	DI6 (SIO)	DXP5	DI4 (SIO)	DXP3	DI2 (SIO)	DXP1	DI0 (SIO)
Process input data valid																
0x02	-	DVS 14	-	DVS 12	-	DVS 10	-	DVS8	-	DVS6	-	DVS4	-	DVS2	-	DVS0
IO-Link process input data																
0x03...	3 words per port															
0x05																
...																
0x18...																
0x1A																

Instance 124 – 8 byte IN/8 byte OUT, diagnostics

The description of the input data can be found in chapter “Operating” [▶ 127]

Word no.	Bit no.															
	15	14	13	12	11	10	9	8	7	6	5	4	3	2	1	0
Status word																
0x00	-	FCE	-	-	-	-	V1	-	V2	-	-	-	-	-	-	Diag
Inputs																
0x01	-	DI14 (SIO)	-	DI12 (SIO)	-	DI10 (SIO)	-	DI8 (SIO)	DXP7	DI6 (SIO)	DXP5	DI4 (SIO)	DXP3	DI2 (SIO)	DXP1	DI0 (SIO)
Process input data valid																
0x02	-	DVS 14	-	DVS 12	-	DVS 10	-	DVS8	-	DVS6	-	DVS4	-	DVS2	-	DVS0
IO-Link process input data																
0x03... 0x06 ... 0x1F... 0x22	4 words per port															
Diagnostics																
VAUX1/VAUX2																
0x23	VERR V2 X7 ch15	VERR V2 X6 ch13	VERR V2 X5 ch11	VERR V2 X4 ch9	-	-	-	-	VERR V1 X7 ch14	VERR V1 X6 ch12	VERR V1 X5 ch10	VERR V1 X4 ch08	VERR V1 X3 ch6/7	VERR V1 X2 ch4/5	VERR V1 X1 ch2/3	VERR V1 X0 ch0/1
DXP channels																
0x24	-	-	-	-	-	-	-	-	ERR DXP 7	-	ERR DXP 5	-	ERR DXP 3	-	ERR DXP 1	-
IO-Link port diagnostics																
Port 1																
0x25	GEN ERR	OVL	V HIGH	V LOW	ULVE	LLVU	O TMP	PRM ERR	EVT1	EVT2	PD INV	HW ERR	DS ERR	CFG ERR	PPR	-
...																
Port 8																
0x2C	GEN ERR	OVL	V HIGH	V LOW	ULVE	LLVU	O TMP	PRM ERR	EVT1	EVT2	PD INV	HW ERR	DS ERR	CFG ERR	PPR	-

Instance 125 – 8 byte IN/8 byte OUT

The description of the input data can be found in chapter “Operating” [▶ 127]

Word no.	Bit no.															
	15	14	13	12	11	10	9	8	7	6	5	4	3	2	1	0
Status word																
0x00	-	FCE	-	-	-	-	V1	-	V2	-	-	-	-	-	-	Diag
Inputs																
0x01	-	DI14 (SIO)	-	DI12 (SIO)	-	DI10 (SIO)	-	DI8 (SIO)	DXP7	DI6 (SIO)	DXP5	DI4 (SIO)	DXP3	DI2 (SIO)	DXP1	DI0 (SIO)
Process input data valid																
0x02	-	DVS 14	-	DVS 12	-	DVS 10	-	DVS8	-	DVS6	-	DVS4	-	DVS2	-	DVS0
IO-Link process input data																
0x03... 0x06 ... 0x1F... 0x22	4 words per port															

Output assembly instances

EtherNet/IP Connection	Output Assembly		Control word [byte]	DXP outputs [byte]	IO-Link outputs [byte]	VAUX [byte]
	Instance	Size [8 bit]				
Exclusive Owner	104	262	2	2	256	2
IOL 4 IN/4 OUT	150	38	2	2	32	2
IOL 6 IN/6 OUT	151	54	2	2	48	2
IOL 8 IN/8 OUT	152	70	2	2	64	2

Instance 104 – Exclusive Owner

The description of the output data can be found in chapter “Operating” [▶ 129]

Word no.	Bit no.															
	15	14	13	12	11	10	9	8	7	6	5	4	3	2	1	0
Control Word																
0x00	-	reserved														
DXP outputs																
0x01	-	-	-	-	-	-	-	-	DXP7	-	DXP5	-	DXP3	-	DXP1	-
IO-Link process output data																
0x02	16 words per port															
...																
0x11																
...																
0x72																
...																
0x81																
VAUX1/VAUX2																
0x82	VAUX2, Pin2 X7 (Ch15)	VAUX2, Pin2 X6 (Ch13)	VAUX2, Pin2 X5 (Ch11)	VAUX2, Pin2 X4 (Ch9)	-	-	-	-	VAUX1, Pin1 X7 (Ch14)	VAUX1, Pin1 X6 (Ch12)	VAUX1, Pin1 X5 (Ch10)	VAUX1, Pin1 X4 (Ch8)	VAUX1, Pin1 X3 (Ch6/7)	VAUX1, Pin1 X2 (Ch2/5)	VAUX1, Pin1 X1 (Ch2/3)	VAUX1, Pin1 X0 (Ch0/1)

Instance 150 – 4 byte IN/4 byte OUT

The description of the output data can be found in chapter “Operating” [► 130]

Word no.	Bit no.															
	15	14	13	12	11	10	9	8	7	6	5	4	3	2	1	0
Control Word																
0x00	-	reserved														
DXP outputs																
0x01	-	-	-	-	-	-	-	-	DXP7	-	DXP5	-	DXP3	-	DXP1	-
IO-Link process output data																
0x02	2 words per port															
...																
0x03																
...																
0x10																
...																
0x11																
VAUX1/VAUX2																
0x12	VAUX2 pin2 X7 (ch15)	VAUX2 pin2 X6 (ch13)	VAUX2 pin2 X5 (ch11)	VAUX2 pin2 X4 (ch9)	-	-	-	-	VAUX1 pin1 X7 (ch14)	VAUX1 pin1 X6 (ch12)	VAUX1 pin1 X5 (ch10)	VAUX1 pin1 X4 (ch8)	VAUX1 pin1 X3 (ch6/7)	VAUX1 pin1 X2 (ch4/5)	VAUX1 pin1 X1 (ch2/3)	VAUX1 pin1 X0 (ch0/1)

Instance 151 – 6 byte IN/6 byte OUT

The description of the output data can be found in chapter “Operating” [► 130]

Word no.	Bit no.															
	15	14	13	12	11	10	9	8	7	6	5	4	3	2	1	0
Control Word																
0x00	-	reserved														
DXP outputs																
0x01	-	-	-	-	-	-	-	-	DXP7	-	DXP5	-	DXP3	-	DXP1	-
IO-Link process output data																
0x02	3 words per port															
...																
0x04																
...																
0x17																
...																
0x19																
VAUX1/VAUX2																
0x1A	VAUX2 pin2 X7 (ch15)	VAUX2 pin2 X6 (ch13)	VAUX2 pin2 X5 (ch11)	VAUX2 pin2 X4 (ch9)	-	-	-	-	VAUX1 pin1 X7 (ch14)	VAUX1 pin1 X6 (ch12)	VAUX1 pin1 X5 (ch10)	VAUX1 pin1 X4 (ch8)	VAUX1 pin1 X3 (ch6/7)	VAUX1 pin1 X2 (ch4/5)	VAUX1 pin1 X1 (ch2/3)	VAUX1 pin1 X0 (ch0/1)

Instance 152 – 8 byte IN/8 byte OUT

The description of the output data can be found in chapter “Operating” [► 130]

Word no.	Bit no.															
	15	14	13	12	11	10	9	8	7	6	5	4	3	2	1	0
Control Word																
0x00	-	reserved														
DXP outputs																
0x01	-	-	-	-	-	-	-	-	DXP7	-	DXP5	-	DXP3	-	DXP1	-
IO-Link process output data																
0x02	4 words per port															
...																
0x05																
...																
0x1E																
...																
0x21																
VAUX1/VAUX2																
0x22	VAUX2 pin2 X7 (ch15)	VAUX2 pin2 X6 (ch13)	VAUX2 pin2 X5 (ch11)	VAUX2 pin2 X4 (ch9)	-	-	-	-	VAUX1 pin1 X7 (ch14)	VAUX1 pin1 X6 (ch12)	VAUX1 pin1 X5 (ch10)	VAUX1 pin1 X4 (ch8)	VAUX1 pin1 X3 (ch6/7)	VAUX1 pin1 X2 (ch4/5)	VAUX1 pin1 X1 (ch2/3)	VAUX1 pin1 X0 (ch0/1)

Connection Manager Object (0x05)

This object is used for connection and connectionless communications, including establishing connections across multiple subnets.

The following description of the Ethernet Link Object is taken from the CIP specification, Vol. 2, Rev. 2.1 by ODVA & ControlNet International Ltd. and adapted to the Turck products.

Common services

Service code		Class	Instance	Meaning
Dec.	Hex.			
84	0x54	no	yes	FWD_OPEN_CMD (opens a connection)
78	0x4E	no	yes	FWD_CLOSE_CMD (closes a connection)
82	0x52	no	yes	UNCONNECTED_SEND_CMD

TCP/IP Interface Object (0xF5)

The following description of the Ethernet Link Object is taken from the CIP specification, Vol. 2, Rev. 1.1 by ODVA & ControlNet International Ltd. and adapted to the Turck products.

Class attributes

Attr. no. Dec.	Hex.	Designation	Get/set	Type	Value
1	0x01	Revision	G	UINT	1
2	0x02	Max. object instance	G	UINT	1
3	0x03	Number of instances	G	UINT	1
6	0x06	Max. class identifier	G	UINT	7
7	0x07	Max. instance attribute	G	UINT	6

Instance Attributes

Attr. no. Dec.	Hex.	Designation	Get/set	Type	Value
1	0x01	Status	G	DWORD	Interface status
2	0x02	Configuration capability	G	DWORD	Interface Capability Flag
3	0x03	Configuration control	G/S	DWORD	Interface Control Flag
4	0x04	Physical link object	G	STRUCT	
		Path size		UINT	Number of 16 bit words: 0x02
		Path		Padded EPATH	0x20, 0xF6, 0x24, 0x01
5	0x05	Interface configuration	G	Structure of:	TCP/IP Network Interface Configuration
		IP address	G	UDINT	Actual IP address
		Network mask	G	UDINT	Actual network mask
		Gateway addr.	G	UDINT	Actual default gateway
		Name server	G	UDINT	0 = no server address configured
		Name server 2	G	UDINT	0 = no server address configured for server 2
Domain name	G	UDINT	0 = no domain name configured		
6	0x06	Host name	G	String	0 = no host name configured
12	0x0C	QuickConnect	G/S	BOOL	0 = deactivate 1 = activate

Common services

Service code		Class	Instance	Meaning
Dec.	Hex.			
1	0x01	Yes	Yes	Get_Attribute_All
2	0x02	No	No	Set_Attribute_All
14	0x0E	Yes	Yes	Get_Attribute_Single
16	0x10	No	Yes	Set_Attribute_Single

Interface status

This status attribute shows the status of the TCP/IP network interface. Refer to the TCP/IP Object Status Diagram for details on the states of this status attribute.

Bit	Designation	Meaning
0...3	Interface Configuration Status	Indicates the status of the Interface Configuration attribute: 0 = The Interface Configuration attribute has not been configured 1 = The Interface Configuration attribute contains valid configuration. 2...15 = reserved
4...31	reserved	

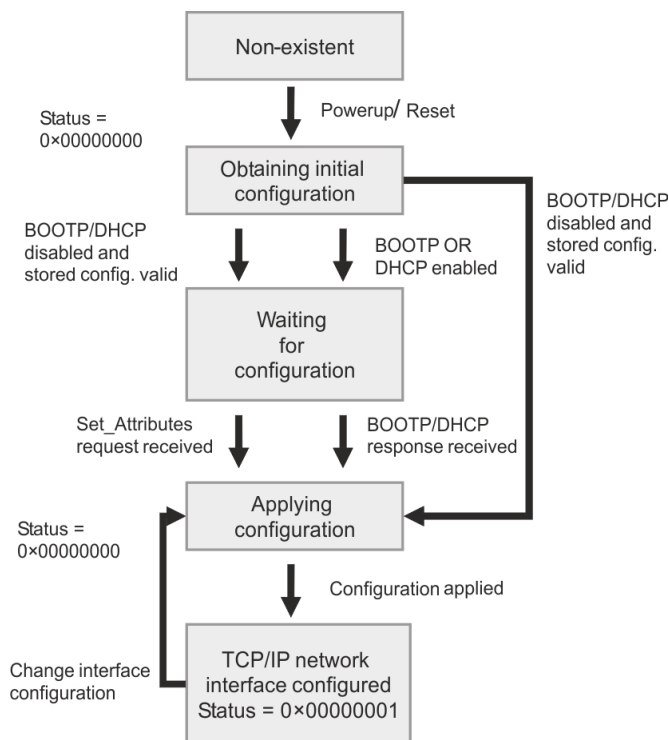

Fig. 49: TCP/IP object state diagram (acc. to CIP Spec., Vol.2, Rev. 1.1)

Configuration capability

The Configuration Capability indicates the device's support for optional network configuration capability.

Bit	Designation	Meaning	Value
0	BOOTP client	This device supports network configuration via BOOTP.	1
1	DNS client	The device is capable of resolving host names by querying a DNS server.	0
2	DHCP client	This device supports network configuration via BOOTP.	1

Configuration control

The Configuration Control attribute is used to control network configuration options.

Bit	Designation	Meaning
0...3	Startup configuration	Determines how the device shall obtain its initial configuration. The device should use the previously stored interface configuration (for example, from non-volatile memory, set by hardware switch, etc.). 1...3 = reserved
4	DNS enable	Always 0
5...31	reserved	Set to 0

Interface configuration

This attribute contains the configuration parameters required to operate a TCP/IP device.

To change this attribute, proceed as follows:

- ▶ Read out the attribute.
- ▶ Change the parameters.
- ▶ Set the attribute.
- ⇒ The TCP/IP Interface Object applies the new configuration upon completion of the Set service. If the value of the Startup Configuration bits (Configuration Control attribute) is 0, the new configuration is stored in non-volatile memory.

The device does not reply to the set service until the values are safely stored to non-volatile memory.

An attempt to set any of the components of the Interface Configuration attribute to invalid values results in an error (status code 0x09) returned from the Set service. If initial configuration is obtained via BOOTP or DHCP, the Interface Configuration attribute components are all 0 until the BOOTP or DHCP reply is received. Upon receipt of the BOOTP or DHCP reply, the Interface Configuration attribute shows the configuration obtained via BOOTP/DHCP.

Host Name

The attribute contains the name of the device host. The host name attribute is used when the device supports the DHCP-DNS Update capability and has been configured to use DHCP upon start up. This mechanism allows the DHCP client to forward its host name to the DHCP servers. The DHCP server then updates the DNS data for the client.

Ethernet Link Object (0xF6)

The following description of the Ethernet Link Object is taken from the CIP specification, Vol. 2, Rev. 1.1 by ODVA & ControlNet International Ltd. and adapted to the Turck products.

Class attributes

Attr.-no. Dec.	Hex.	Designation	Get/Set	Type	Value
1	0x01	Revision	G	UINT	1
2	0x02	Max. object instance	G	UINT	1
3	0x03	Number of instances	G	UINT	1
6	0x06	Max. class identifier	G	UINT	7
7	0x07	Max. instance attribute	G	UINT	6

Instance attributes

Attr.-no. Dec.	Hex.	Designation	Get/Set	Type	Value
1	0x01	Interface speed	G	UDINT	Speed in megabit per second (e.g. (z. B. 10, 100, 1000 etc.)
2	0x02	Interface flags	G	DWORD	Interface capability flag
3	0x03	Physical address	G	ARRAY OF USINT	Contains the interface's MAC address (Turck: 00:07:46:xx:xx:xx)
6	0x06	Interface control	G	2 WORD	Allows port-wise changes of the Ethernet-settings
7	0x07	Interface type	G		
10	0x0A	Interface label	G		

Interface flags

Bit	Designation	Meaning	Default value
0	Link status	Indicates whether or not the Ethernet communications interface is connected to an active network. 0 = inactive link 1 = active link	Depends on application
1	Half/full duplex	0 = Half duplex 1 = Full duplex If the Link Status flag is 0, the value of the Half/Full Duplex flag is indeterminate.	Depends on application
2...4	Negotiation status	Indicates the status of the automatic autonegotiation 0 = autonegotiation in progress 1 = autonegotiation and speed detection failed, Using default values for speed and duplex (10Mbps/half duplex). 2 = auto-negotiation failed but detected speed (default: half duplex). 3 = successfully negotiated speed and duplex 4 = Autonegotiation not started, yet Forced speed and duplex.	Depends on application

Bit	Designation	Meaning	Default value
5	Manual setting requires reset	0 = interface can activate changes to link parameters (auto-negotiate, duplex mode, interface speed) automatically 1 = device requires a Reset service to be issued to its Identity Object in order to adapt the changes.	0
6	Local Hardware Fault	0 = interface detects no local hardware fault 1 = local hardware error detected	0

Common services

Service code		Class	Instance	Meaning
Dec.	Hex.			
1	0x01	yes	yes	Get_Attribute_All
14	0x0E	yes	yes	Get_Attribute_Single
76	0x4C	No	yes	Enetlink_Get_and_Clear

8.9.6 VSC-Vendor Specific Classes

In addition to supporting the above named CIP Standard Classes, the device support the vendor specific classes (VSCs) described in the following.

Class Code		Name	Description
Dec.	Hex.		
100	0x64	Gateway Class [▶ 93]	Data and parameters for the field bus specific part of the device.
103	0x67	IO-Link Parameter Object [▶ 94]	ISDU object for acyclic transmission of parameter data between IO-Link master and IO-Link device
137	0x89	IO-Link Port Class [▶ 98]	Parameters and diagnostics of the IO-Link-channels
138	0x8A	IO-Link Events Class [▶ 100]	IO-Link Events
184	0xB8	Basic Class [▶ 101]	Parameters and diagnostics of the digital channels channels
185	0xB9	VAUX Control Class [▶ 104]	Parameters and status for VAUX

Gateway Class (VSC 100)

This class contains all information concerning the whole device.

Object Instance 2, Gateway Instance

Attr. no. Dec.	Hex.	Designation	Get/set	Type	Meaning
109	0x6D	Status word (status register 2)	G	STRUCT	The status word contains general module status information.
115	0x73	On IO connection timeout	G/S	ENUM USINT	Reaction when the time limit for an I/O connection is exceeded: 0: SWITCH IO FAULTED (0): The channels are switched to the substitute value. 1: SWITCH IO OFF (1): The outputs are set to 0. 2: SWITCH IO HOLD (2): No further changes to I/O data. The outputs are held.
138	0x8A	GW status word	G/S	DWORD	Activates or deactivates the mapping of the status word into the device's input data.
139	0x8B	GW control word	G/S	DWORD	Activates or deactivates the mapping of the control word into the device's output data.
140	0x8C	Disable Protocols	G/S	UINT	Deactivation of the used Ethernet protocol. Bit 0: Deactivates EtherNet/IP (cannot be deactivated via the EtherNet/IP interface). Bit 1: Deactivates Modbus TCP Bit 2: Deactivates PROFINET Bit 15: Deactivates the web server

IO-Link Parameter Object (VSC 103)

The IO-Link Parameter Object enables the acyclic transfer of parameter data between the IO-Link master and the IO-Link device.

Instance 1 of the object addresses the IO-Link master

The instance attribute numbers address the IO-Link port at the IO-Link master or the port 0 functions of the IO-Link master.

- 1...n: IO-Link port at IO-Link master, n = number of IO-Link ports at IO-Link master
- 128: Port-0 functions of the IO-Link master

Instance attributes

Common services

Service code	Class	Instance	Service name	
Dec.	Hex.			
14	0x0E	Yes	No	Get_Attribute_Single Returns the content of a specified attribute.
75	0x4B	No	yes	Read_ISDU The service reads parameters from the connected IO-Link device.
76	0x4C	No	yes	Write_ISDU The service writes parameters from the connected IO-Link device.

Read_ISDU - Request

Data	Value/content	Description
Class	0x67	IO-Link Parameter Object
Instance	0x01	Addressing the IO-Link master
Instance attribute	0x01...n, 128	IO-Link port number, or 128 for Port-0 functions
Service code	0x4B	Read_ISDU
Data	Request parameters for the ISDU Read Service	
	Name	Data type Description
Data byte 0	Index (LSB)	UINT LSB from index of the IO-Link ISDU object acc. to IODD
Data byte 1	Index (MSB)	UINT MSB from index of the IO-Link ISDU object acc. to IODD
Data byte 2	Sub index	USINT Sub index from the IO-Link ISDU object acc. to IODD

Read_ISDU – Response

- CIP Service Response, General-Status ≠ 0 → error-free access structure of the response:

Name	Data type	Description
ISDU data	Array of Byte	Read data, max. 232 byte

- CIP Service Response, General-Status ≠ 0 → access error structure of the response:

Name	Data type	Description
IOL_Master Error	UINT	IO-Link master specific, see IO-Link master Error Codes
IOL_Device Error	UINT	IO-Link device specific, see IO-Link device Error Codes and device documentation

Example:

Read access – name of device at port 4 is read out

Data	Value/content	Description
Class	0x67	IO-Link Parameter Object
Instance	0x01	Addressing the IO-Link master
Instance attribute	0x04	IO-Link port number
Service code	0x4B	Read_ISDU: read access
Data	Request parameters for the ISDU Read Service	
	Name	Data type Description
Data byte 0	0x12	UINT Index for the product name in the device (e.g. Turck I/O hub TBIL-M1-16DXP) according to IODD
Data byte 1	0x00	UINT -
Data byte 2	0x00	USINT The index has no sub index.

- CIP Service Response:

Name	Data type	Description
ISDU data	Array of Byte	Error-free access: Content: 54 42 49 4C 2D 4D 31 2D 31 36 44 58 50 (TBIL-M1-16DXP) Access error: Content: Error code

Write_ISDU – Request

Data	Value/content	Description	
Class	0x67	IO-Link Parameter Object	
Instance	0x01	Addressing the IO-Link master	
Instance attribute	0x01...n, 128	IO-Link port number, or 128 for Port-0 functions	
Service code	0x4C	Write_ISDU	
Data	Request parameters for the ISDU write service		
	Name	Data type	Description
Data byte 0	Index (LSB)	UINT	LSB from index of the IO-Link ISDU object acc. to IODD
Data byte 1	Index (MSB)	UINT	MSB from index of the IO-Link ISDU object acc. to IODD
Data byte 2	Sub index	USINT	Sub index from the IO-Link ISDU object acc. to IODD
Data byte 3...data byte n	Data	Array of Byte	Parameter data (n= length of ISDU object + 3)

Write_ISDU – Response

- CIP Service Response, general status = 0 → error-free access
Service response without further data
- CIP Service Response, general status ≠ 0 → access error
structure of the response:

Name	Data type	Description
IOL_Master Error	UINT	IO-Link master specific, see IO-Link master Error Codes
IOL_Device Error	UINT	IO-Link device specific, see IO-Link device Error Codes and device documentation

Example:

Write access – Application Specific Tag is written into the device at port 4

Data	Value/content	Description
Class	0x67	IO-Link Parameter Object
Instance	0x01	Addressing the IO-Link master
Instance attribute	0x04	IO-Link port number
Service code	0x4C	Write_ISDU: Write access

Data	Value/content	Description
Data	Request parameters for the ISDU write service	
	Name	Data type Description
	0x18	UINT Index for the application specific tag in the device (e.g. In Turck I/O-Hub TBIL-M1-16DXP)
	0x00	USINT The index has no sub index.
	Byte 0: 0x54 Byte 1: 0x65 Byte 2: 0x6D Byte 3: 0x70 Byte 4: 0x65 ... Byte 17: 0x31 Byte 18...31: 00	The Application Specific Tag of the device can consist of 32 byte, example: ASCII: Temperature_sensor1 Hex: 54 65 6d 70 65 72 61 74 75 72 65 5f 73 65 6e 73 6f 72 31 00 00... The remainder of the 32 bytes not required is filled with 00.

IO-Link master error codes

Error code	Designation acc. to specification	Meaning
0x0000	No error	No error
0x7000	IOL_CALL Conflict	Unexpected write-request, read request expected
0x7001	Wrong IOL_CALL	Decoding error
0x7002	Port blocked	The accessed port is occupied by another task
...	reserved	
0x8000	Timeout	Timeout, IOL master or IOL device port busy
0x8001	Wrong index	Error: IOL index < 32767 or > 65535 selected
0x8002	Wrong port address	Port address not available
0x8002	Wrong port function	Port function not available
...	reserved	

IO-Link device error codes

Error code	Designation acc. to specification	Meaning
0x1000	COM_ERR	Communication error Possible source: the addressed port is parameterized as digital input DI and is not in IO-Link mode
0x1100	I_SERVICE_TIMEOUT	Timeout in communication, device does not respond in time
0x5600	M_ISDU_CHECKSUM	Master reports checksum error, access to device not possible
0x5700	M_ISDU_ILLEGAL	Device can not respond to master request
0x8000	APP_DEV	Application error in the device
0x8011	IDX_NOTAVAIL	Index not available
0x8012	SUBIDX_NOTAVAIL	Sub-Index not available
0x8020	SERV_NOTAVAIL	The service is temporarily not available.

Error code	Designation acc. to specification	Meaning
0x8021	SERV_NOTAVAIL_LOCCTRL	Service temporarily not available, device is busy (e. g. teaching or parameterization of the device at the device active)
0x8022	SERV_NOTAVAIL_DEVCTRL	Service temporarily not available, device is busy (e. g. teaching or parameterization of the device via DTM/PLC etc. active)
0x8023	IDX_NOT_WRITEABLE	Access denied, Index cannot be written
0x8030	PAR_VALOUTOFRNG	Parameter value out of the valid range
0x8031	PAR_VALGTLIM	Parameter value value above the upper limit
0x8032	PAR_VALLTLM	Parameter value value below the lower limit
0x8033	VAL_LENORRRUN	Length of data to be written does not match the length defined for this parameter
0x8034	VAL_LENUNDRUN	
0x8035	FUNC_NOTAVAIL	Function not available in the device
0x8036	FUNC_UNAVAILTEMP	Function temporarily not available in the device
0x8040	PARA_SETINVALID	Invalid parameter: Parameters not consistent with other parameters in the device.
0x8041	PARA_SETINCONSIST	Inconsistent parameters
0x8082	APP_DEVNOTRDY	Application not ready, device busy
0x8100	UNSPECIFIC	Vendor specific, according to device documentation
0x8101...	VENDOR_SPECIFIC	
0x8FF		

IO-Link Port Class (VSC 137)

This class provides one instance per IO-Link port at the IO-Link master module.

Attr. no.	Designation	Get/ set	Type	Meaning
Dec.	Hex.			
Parameters				
1	0x01	Operation mode	G/S USINT	0 = IO-Link without validation 1 = IO-Link with family compatible device 2 = IO-Link with compatible device 3 = IO-Link with identical device 4 = DI (with parameter access) 5...7 = reserved 8 = DI
2	0x02	Data Storage Mode	G/S USINT	0 = activated 1 = overwrite 2 = read in 3 = deactivated, clear
3	0x03	Cycle time	G/S USINT	See [119]
4	0x04	Revision	G/S USINT	0 = automatic 1 = V 1.0
5	0x05	Activate Quick Start-Up	G/S USINT	0 = no 1 = yes

Attr. no.		Designation	Get/ set	Type	Meaning
Dec.	Hex.				
6	0x06	Device parameterization via GSD	G/S	USINT	0 = no 1 = yes
7	0x07	Process input data invalid	G/S	USINT	0 = diagnostics generated 1 = no diagnostic generated
8	0x08	Deactivate diagnostics	G/S	USINT	0 = no 1 = notifications 2 = notifications and warnings 3 = yes
9	0x09	Process input data mapping	G/S	USINT	0 = direct 1 = swap 16 bit 2 = swap 32 bit 3 = swap all
10	0x0A	Process output data mapping	G/S	USINT	0 = direct 1 = swap 16 bit 2 = swap 32 bit 3 = swap all
11	0x0B	Vendor ID	G/S	INT	
12	0x0C	Device ID	G/S	DINT	
Diagnostics					
13	0x0D	Wrong or missing device	G	USINT	0 = inactive 1 = active
14	0x0E	Data storage error	G	USINT	0 = inactive 1 = active
15	0x0F	Process input data invalid	G	USINT	0 = inactive 1 = active
16	0x10	Hardware error	G	USINT	0 = inactive 1 = active
17	0x11	Maintenance events	G	USINT	0 = inactive 1 = active
18	0x12	Out-of-specification events	G	USINT	0 = inactive 1 = active
19	0x13	Parameterization error	G	USINT	0 = inactive 1 = active
20	0x14	Over temperature	G	USINT	0 = inactive 1 = active
21	0x15	Lower limit value under-run	G	USINT	0 = inactive 1 = active
22	0x16	Upper limit value exceeded	G	USINT	0 = inactive 1 = active
23	0x17	Under-voltage	G	USINT	0 = inactive 1 = active

Attr. no.	Designation	Get/ set	Type	Meaning
Dec.	Hex.			
24	0x18	Overvoltage	G	USINT 0 = inactive 1 = active
25	0x19	Overload	G	USINT 0 = inactive 1 = active
26	0x1A	Common error	G	USINT 0 = inactive 1 = active
27	0x1B	Port parameterization error	G	USINT 0 = inactive 1 = active
Process data				
28	0x1C	Input data word 0	G	USINT
...	G	USINT
43	0x2B	Input data word 15	G	USINT
44	0x2C	Output data word 0	G	USINT
...	G	USINT
59	0x3B	Output data word 15	G	USINT

IO-Link Events Class (VSC 138)

Attr. no.	Designation	Get/Set	Type	Meaning
Dec.	Hex.			
1	0x01	IOL-Event 1 – port	G	USINT Port no. of the port which sends the 1st IO-Link Event.
...	...			
16	0x10	IOL-Event 16 – port	G	USINT Port no. of the port which sends the 16th IO-Link Event.
17	0x11	IOL-Event 1 – qualifier	G	USINT Qualifier of the 1st IO-Link event
...	...			
32	0x20	IOL-Event 16 – qualifier	G	USINT Qualifier of the 1st IO-Link event
33	0x21	IOL-Event 1 – Event Code	G	USINT Event code of the 1st IO-Link event
...	...			
48	0x30	IOL-Event 16 – Event Code	G	USINT Event code of the 1st IO-Link event

Basic Class (VSC 184)

Attr. no.	Designation		Get/set	Type	Meaning
Dec.	Hex.				
1	0x01	DXP 1 - Manual output reset after overcurrent	G/S	USINT	0 = no 1 = yes
2	0x02	DXP 3 - Manual output reset after overcurrent	G/S	USINT	0 = no 1 = yes
3	0x03	DXP 5 - Manual output reset after overcurrent	G/S	USINT	0 = no 1 = yes
4	0x04	DXP 7 - Manual output reset after overcurrent	G/S	USINT	0 = no 1 = yes
5	0x05	DXP 1 - Activate output	G/S	USINT	0 = no 1 = yes
6	0x06	DXP 3 - Activate output	G/S	USINT	0 = no 1 = yes
7	0x07	DXP 5 - Activate output	G/S	USINT	0 = no 1 = yes
8	0x08	DXP 7 - Activate output	G/S	USINT	0 = no 1 = yes
9	0x09	Overcurrent VAUX1 pin 1 X0 (Ch0/1)	G	USINT	0 = inactive 1 = active
10	0x0A	Overcurrent VAUX1 pin 1 X1 (Ch2/3)	G	USINT	0 = inactive 1 = active
11	0x0B	Overcurrent VAUX1 pin 1 X2 (Ch4/5)	G	USINT	0 = inactive 1 = active
12	0x0C	Overcurrent VAUX1 pin 1 X3 (Ch6/7)	G	USINT	0 = inactive 1 = active
13	0x0D	Overcurrent VAUX1 pin 1 X4 (Ch8)	G	USINT	0 = inactive 1 = active
14	0x0E	Overcurrent VAUX2 pin 2 X4 (Ch9)	G	USINT	0 = inactive 1 = active
15	0x0F	Overcurrent VAUX1 pin 1 X5 (Ch10)	G	USINT	0 = inactive 1 = active
16	0x10	Overcurrent VAUX2 pin 2 X5 (Ch11)	G	USINT	0 = inactive 1 = active
17	0x11	Overcurrent VAUX1 pin 1 X6 (Ch12)	G	USINT	0 = inactive 1 = active
18	0x12	Overcurrent VAUX2 pin 2 X6 (Ch13)	G	USINT	0 = inactive 1 = active
19	0x13	Overcurrent VAUX1 pin 1 X7 (Ch14)	G	USINT	0 = inactive 1 = active
20	0x14	Overcurrent VAUX2 pin 2 X7 (Ch15)	G	USINT	0 = inactive 1 = active
21	0x15	DXP 1 – Overcurrent output	G	USINT	0 = inactive 1 = active
22	0x16	DXP 3 – Overcurrent output	G	USINT	0 = inactive 1 = active

Attr. no.	Designation		Get/set	Type	Meaning
Dec.	Hex.				
23	0x17	DXP 5 – Overcurrent output	G	USINT	0 = inactive 1 = active
24	0x18	DXP 7 – Overcurrent output	G	USINT	0 = inactive 1 = active
25	0x19	IOL 0 – DI input	G	USINT	0 = off 1 = on
26	0x1A	IOL 2 – DI input	G	USINT	0 = off 1 = on
27	0x1B	IOL 4 – DI input	G	USINT	0 = off 1 = on
28	0x1C	IOL 6 – DI input	G	USINT	0 = off 1 = on
29	0x1D	IOL 8 – DI input	G	USINT	0 = off 1 = on
30	0x1E	IOL 10 – DI input	G	USINT	0 = off 1 = on
31	0x1F	IOL 12 – DI input	G	USINT	0 = off 1 = on
32	0x20	IOL 14 – DI input	G	USINT	0 = off 1 = on
33	0x21	IOL0 - Input value valid (Data Valid Signal)	G	USINT	0 = no 1 = yes
34	0x22	IOL0 - Input value valid (Data Valid Signal)	G	USINT	0 = no 1 = yes
35	0x23	IOL4 - Input value valid (Data Valid Signal)	G	USINT	0 = no 1 = yes
36	0x24	IOL6 - Input value valid (Data Valid Signal)	G	USINT	0 = no 1 = yes
37	0x25	IOL8 - Input value valid (Data Valid Signal)	G	USINT	0 = no 1 = yes
38	0x26	IOL10 - Input value valid (Data Valid Signal)	G	USINT	0 = no 1 = yes
39	0x27	IOL12 - Input value valid (Data Valid Signal)	G	USINT	0 = no 1 = yes
40	0x28	IOL14 - Input value valid (Data Valid Signal)	G	USINT	0 = no 1 = yes
41	0x29	DXP 1 – Input value	G	USINT	0 = off 1 = on
42	0x2A	DXP 3 – Input value	G	USINT	0 = off 1 = on
43	0x2B	DXP 5 – Input value	G	USINT	0 = off 1 = on
44	0x2C	DXP 7 – Input value	G	USINT	0 = off 1 = on
45	0x2D	DXP 1 – Output value	G	USINT	0 = off 1 = on

Attr. no.		Designation	Get/set	Type	Meaning
Dec.	Hex.				
46	0x2E	DXP 3 – Output value	G	USINT	0 = off 1 = on
47	0x2F	DXP 5 – Output value	G	USINT	0 = off 1 = on
48	0x30	DXP 7 – Output value	G	USINT	0 = off 1 = on

VAUX Control Class (VSC 184)

This class contains parameters and diagnostics for the monitoring of 24 VDC sensor and actuator supply.

Attr. no. Dec.	Hex.	Designation	Get/set	Type	Meaning
Activate VAUX1 monitoring					
1	0x01	VAUX Control - VAUX1 pin1 X0 (Ch0/1)	G/S	USINT	0 = 24 VDC 1 = switchable 2 = off
2	0x02	VAUX Control - VAUX1 pin1 X1 (Ch2/3)	G/S	USINT	0 = 24 VDC 1 = switchable 2 = off
3	0x03	VAUX Control - VAUX1 pin1 X2 (Ch4/5)	G/S	USINT	0 = 24 VDC 1 = switchable 2 = off
4	0x04	VAUX Control - VAUX1 pin1 X3 (Ch6/7)	G/S	USINT	0 = 24 VDC 1 = switchable 2 = off
5	0x05	VAUX Control - VAUX1 pin1 X4 (Ch8)	G/S	USINT	0 = 24 VDC 1 = switchable 2 = off
7	0x07	VAUX Control - VAUX1 pin1 X5 (Ch10)	G/S	USINT	0 = 24 VDC 1 = switchable 2 = off
9	0x09	VAUX Control - VAUX1 pin1 X6 (Ch12)	G/S	USINT	0 = 24 VDC 1 = switchable 2 = off
11	0x0B	VAUX Control - VAUX1 pin1 X7 (Ch14)	G/S	USINT	0 = 24 VDC 1 = switchable 2 = off
Activate VAUX2 monitoring					
6	0x06	VAUX Control - VAUX2 pin2 X4 (Ch9)	G/S	USINT	0 = 24 VDC 1 = switchable 2 = off
8	0x08	VAUX Control - VAUX2 pin2 X5 (Ch11)	G/S	USINT	0 = 24 VDC 1 = switchable 2 = off
10	0x0A	VAUX Control - VAUX2 pin2 X6 (Ch13)	G/S	USINT	0 = 24 VDC 1 = switchable 2 = off
12	0x0C	VAUX Control - VAUX2 pin2 X7 (Ch15)	G/S	USINT	0 = 24 VDC 1 = switchable 2 = off
VAUX1 status					
13	0x0D	VAUX Control - VAUX1 pin1 X0 (Ch0/1)	G	USINT	0 = off 1 = on
14	0x0E	VAUX Control - VAUX1 pin1 X1 (Ch2/3)	G	USINT	0 = off 1 = on

Attr. no.		Designation	Get/set	Type	Meaning
Dec.	Hex.				
15	0x0F	VAUX Control - VAUX1 pin1 X2 (Ch4/5)	G	USINT	0 = off 1 = on
16	0x10	VAUX Control - VAUX1 pin1 X3 (Ch6/7)	G	USINT	0 = off 1 = on
17	0x11	VAUX Control - VAUX1 pin1 X4 (Ch8)	G	USINT	0 = off 1 = on
19	0x13	VAUX Control - VAUX1 pin1 X5 (Ch10)	G	USINT	0 = off 1 = on
21	0x15	VAUX Control - VAUX1 pin1 X6 (Ch12)	G	USINT	0 = off 1 = on
23	0x17	VAUX Control - VAUX1 pin1 X7 (Ch14)	G	USINT	0 = off 1 = on
VAUX2 status					
18	0x12	VAUX Control - VAUX2 pin2 X4 (Ch9)	G	USINT	0 = off 1 = on
20	0x14	VAUX Control - VAUX2 pin2 X5 (Ch11)	G	USINT	0 = off 1 = on
22	0x16	VAUX Control - VAUX2 pin2 X6 (Ch13)	G	USINT	0 = off 1 = on
24	0x18	VAUX Control - VAUX2 pin2 X7 (Ch15)	G	USINT	0 = off 1 = on

8.10 Connecting the Devices to a Rockwell PLC with EtherNet/IP

Used Hardware

The following hardware components are used in this example:

- Rockwell PLC ControlLogix 1756-L72, Logix 5572
- Rockwell Scanner 1756-EN2TR
- Block module TBEN-L5-8IOL

Used Software

The following software tools are used in this example:

- Rockwell RS Logix
- Catalog file for Turck compact stations "TURCK_BLOCK_STATIONS_Vxx.L5K" as part of the file "TBEN-L_ETHERNETIP.zip" (downloadable free of charge under www.turck.com)

Catalog files

Turck provides catalog files "TURCK_BLOCK_STATIONS_Vxx.L5K" for use in Rockwell Automation's RSLogix/Studio5000. The catalog files contain predefined, application-dependent device configurations with different input and output data widths and descriptions of the configuration, input and output tag data. The predefined device configurations correspond to the input and output assembly instances described in the section "Assembly Object" in the chapter "Commissioning Devices with EtherNet/IP" → under "EtherNet/IP standard classes".



NOTE

The catalog file is available in the L5K file format and must be converted to the "ACD" file format before it can be used. The file is opened in RSLogix/Studio5000 and saved as a project (*.ACD).

Prerequisites

- Instance of the programming software RSLogix/Studio5000 with the Catalog files is opened.
- A new project has been created in a second instance of RSLogix/Studio5000.
- The PLC and the Scanner mentioned above have been added to the project in the second instance of RSLogix/Studio5000.

8.10.1 Adding the devices from the catalog files to the new project

- ▶ Right-click the device entry and use **Copy**.

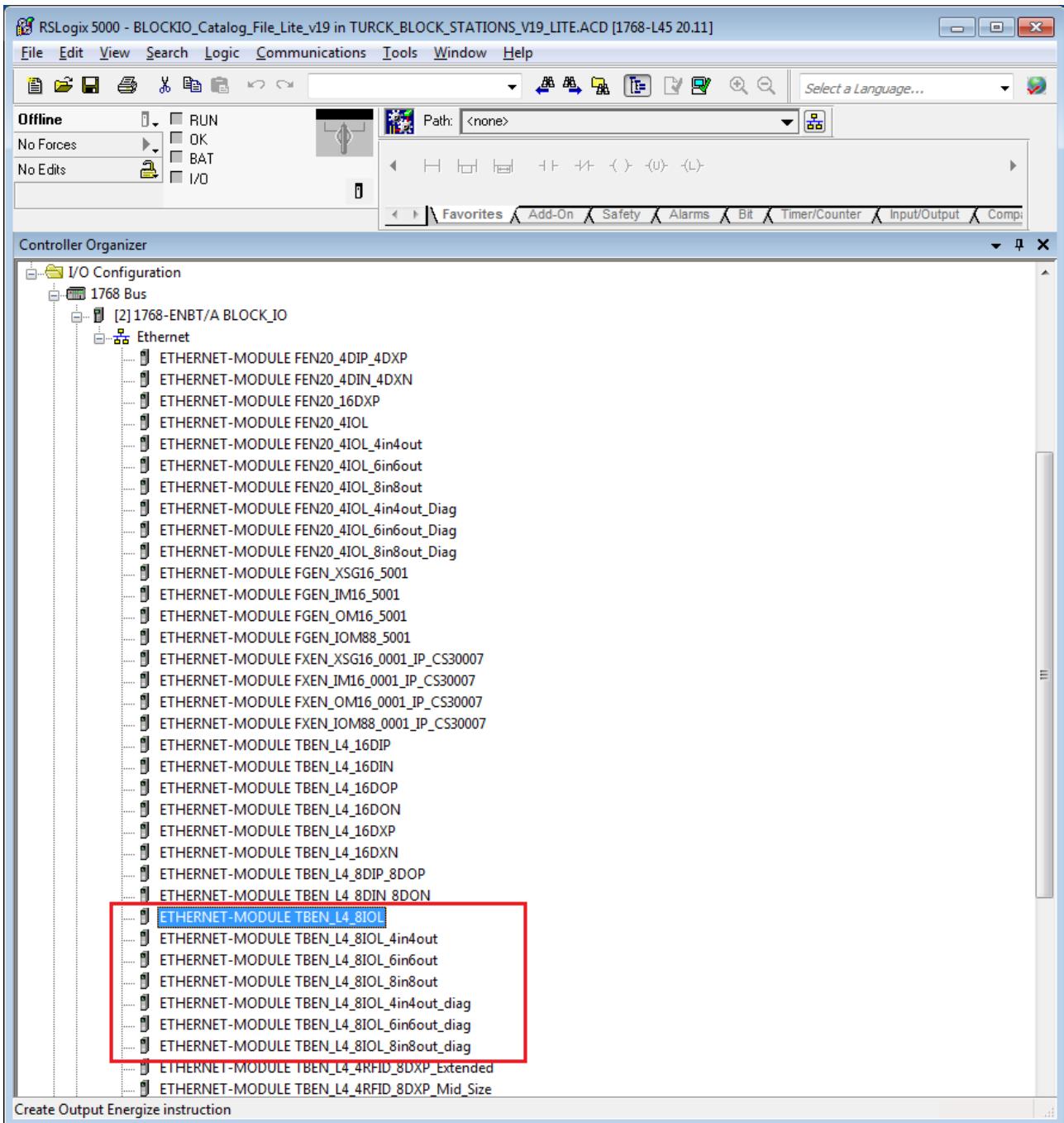

Fig. 50: RSLogix – Copying the device entry from catalog file

- ▶ Right-click the EtherNet/IP-Scanner in the second instance of the RS Logix and add the device to the project via Paste. In this example, the configuration with 4 byte in- and 4 byte output data plus diagnostics **TBEN_L5_8IOL_4in4out_diag** is used.

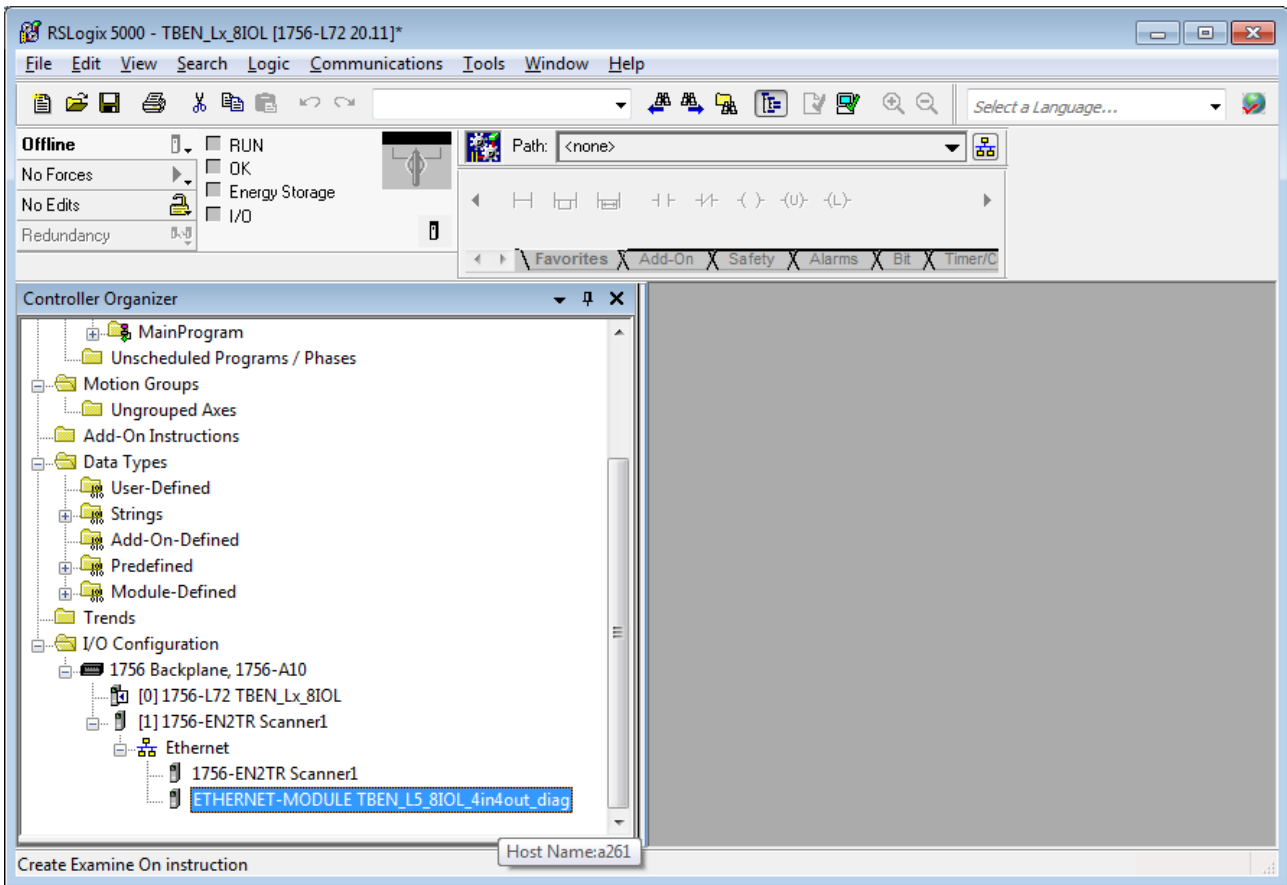

Fig. 51: RSLogix – predefined configurations of TBEN-L5-8IOL in new project

8.10.2 Configuring the device in RS Logix

- ▶ Open the device entry by double-clicking.
- ▶ Assign a module name.
- ▶ Set the IP address of the device.

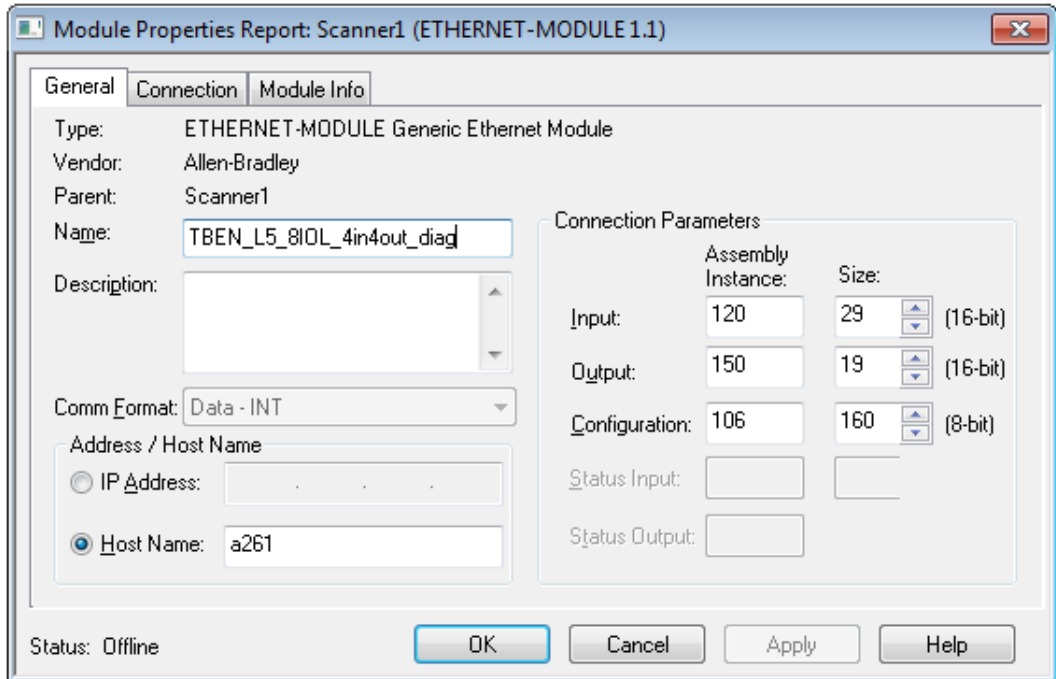

Fig. 52: Setting module name and IP address

- ▶ Optional: Set the connection parameters

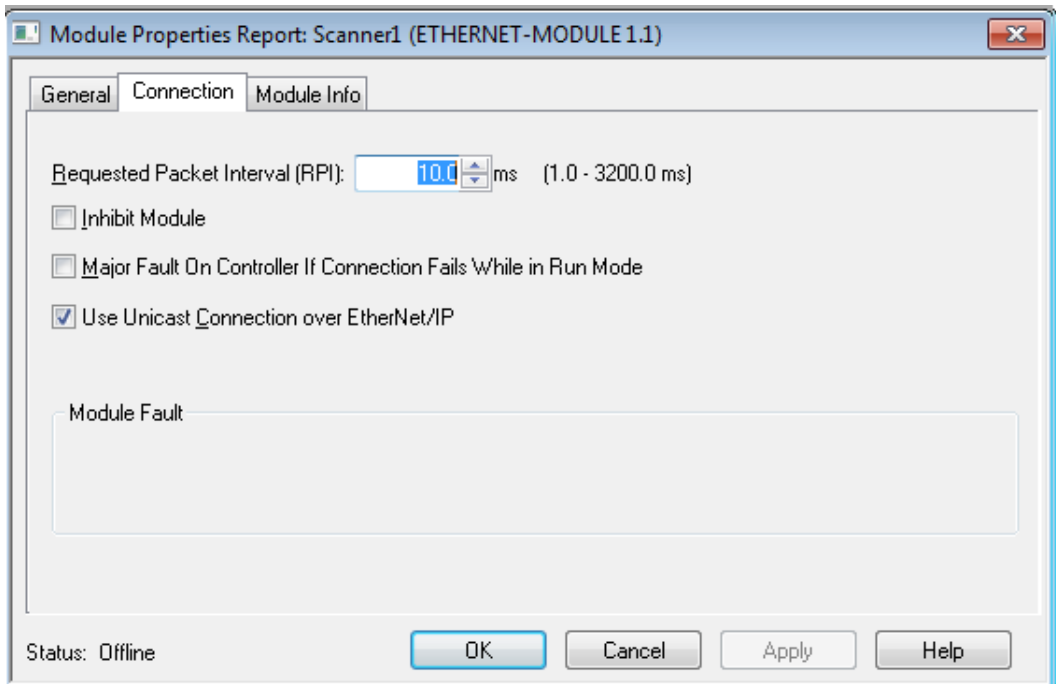

Fig. 53: Setting the connection parameters

8.10.3 Parameterizing the device

- ▶ Open the Controller Tags of the device.
- ▶ Parameterize the device via the Controller Tags (in the example: **TBEN_L5_8IOL_4in-4out_diag:C**).

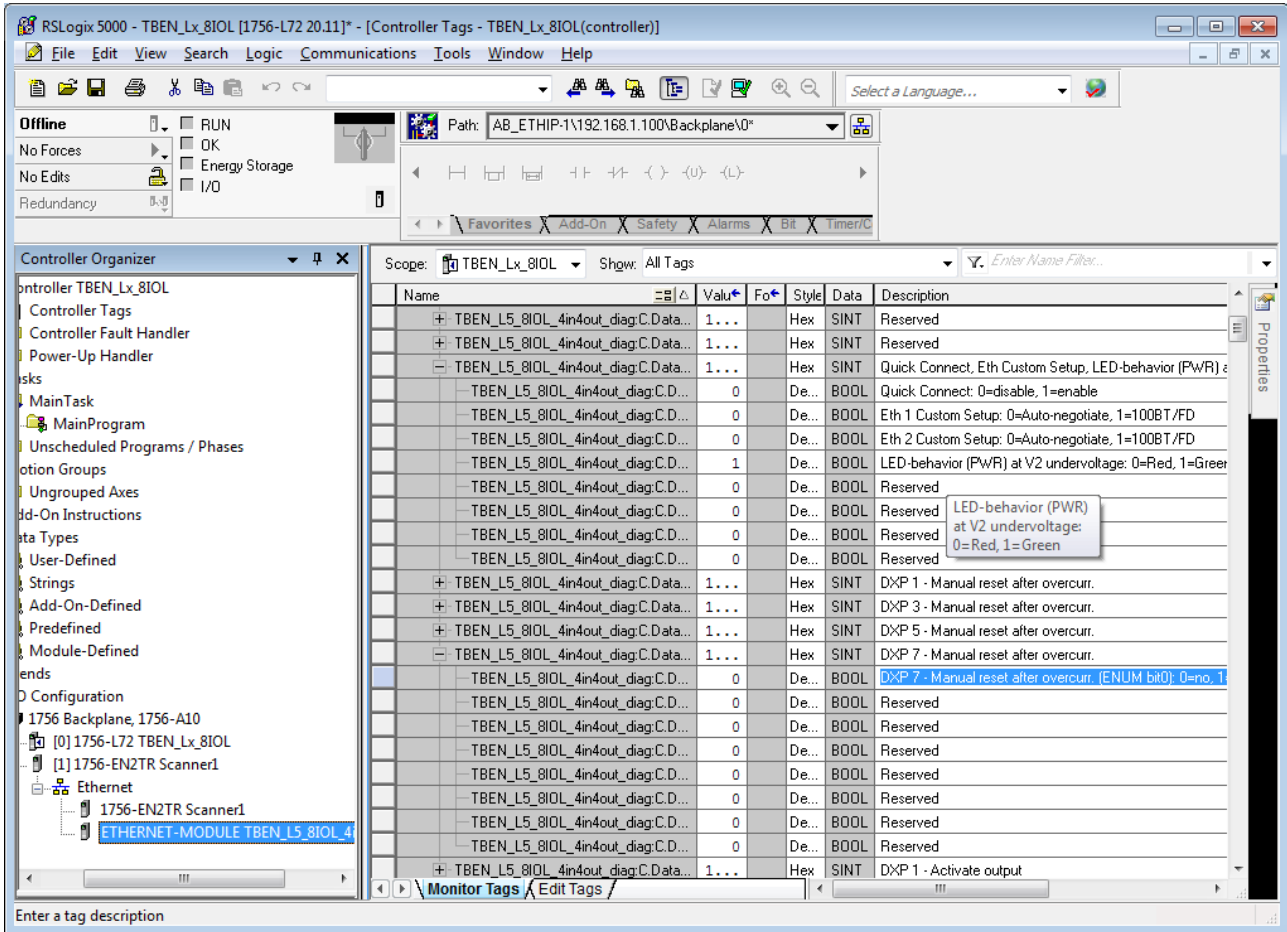

Fig. 54: Parameterizing the Device

8.10.4 Going online with the PLC

- ▶ Search the network via the Who Active function.
- ▶ Select the PLC.
- ▶ Set the communication path via Set Project Path.
- ⇒ The communication path is set.

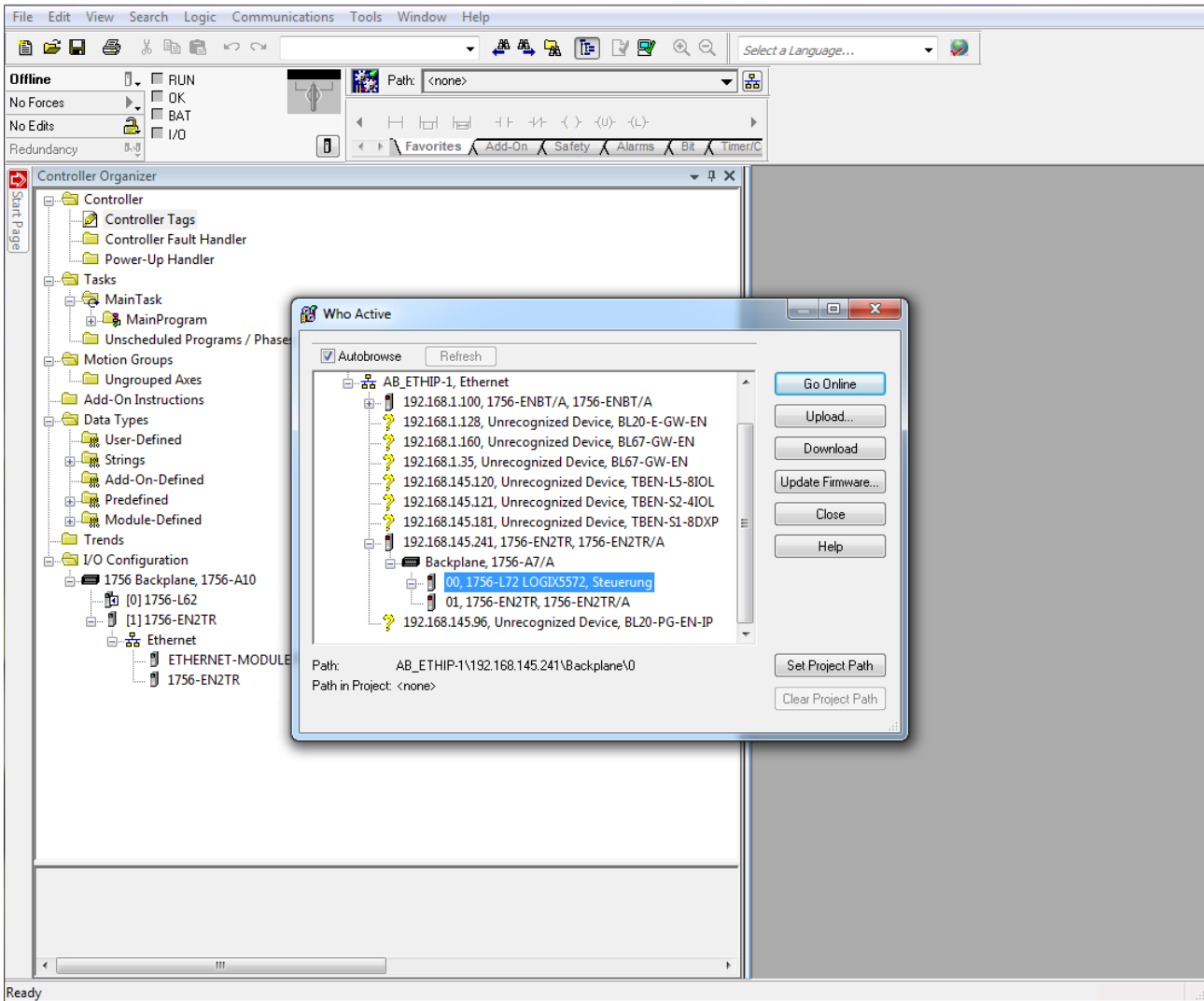

Fig. 55: Setting the communication path

- ▶ Select the PLC.
- ▶ Click **Go online**.

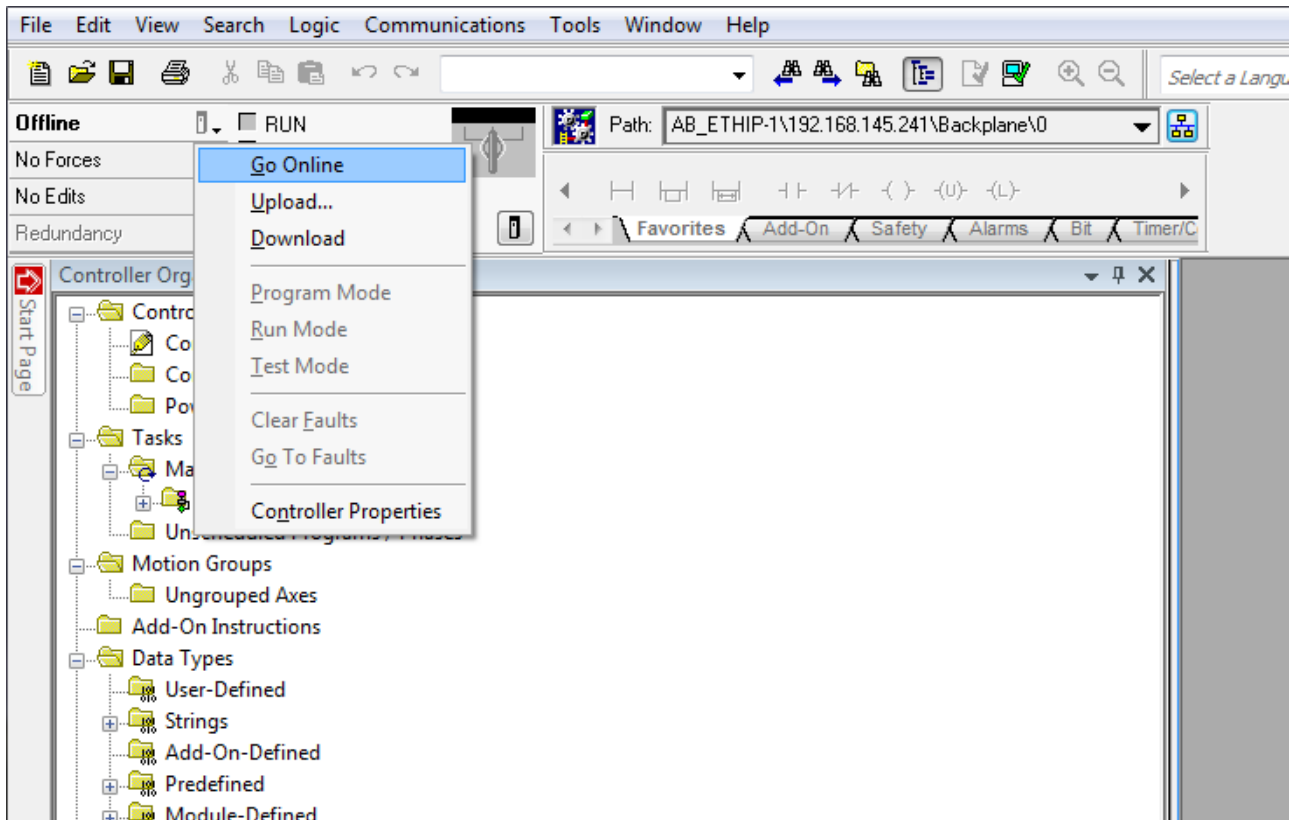

Fig. 56: Going online with the device

- ▶ Click **Download** In the following dialog (Connect To Go Online)
- ▶ Confirm all following messages.
- ⇒ The project is loaded down to the controller. The connection is established.

8.10.5 Reading process data

- ▶ Open the Controller Tags in the project tree by double-clicking the entry.
- ⇒ The access to parameter data (TBEN_L5_8IOL_...:C), input data (TBEN_L5_8IOL_...:I) and output data (TBEN_L5_8IOL_...:O) is possible.

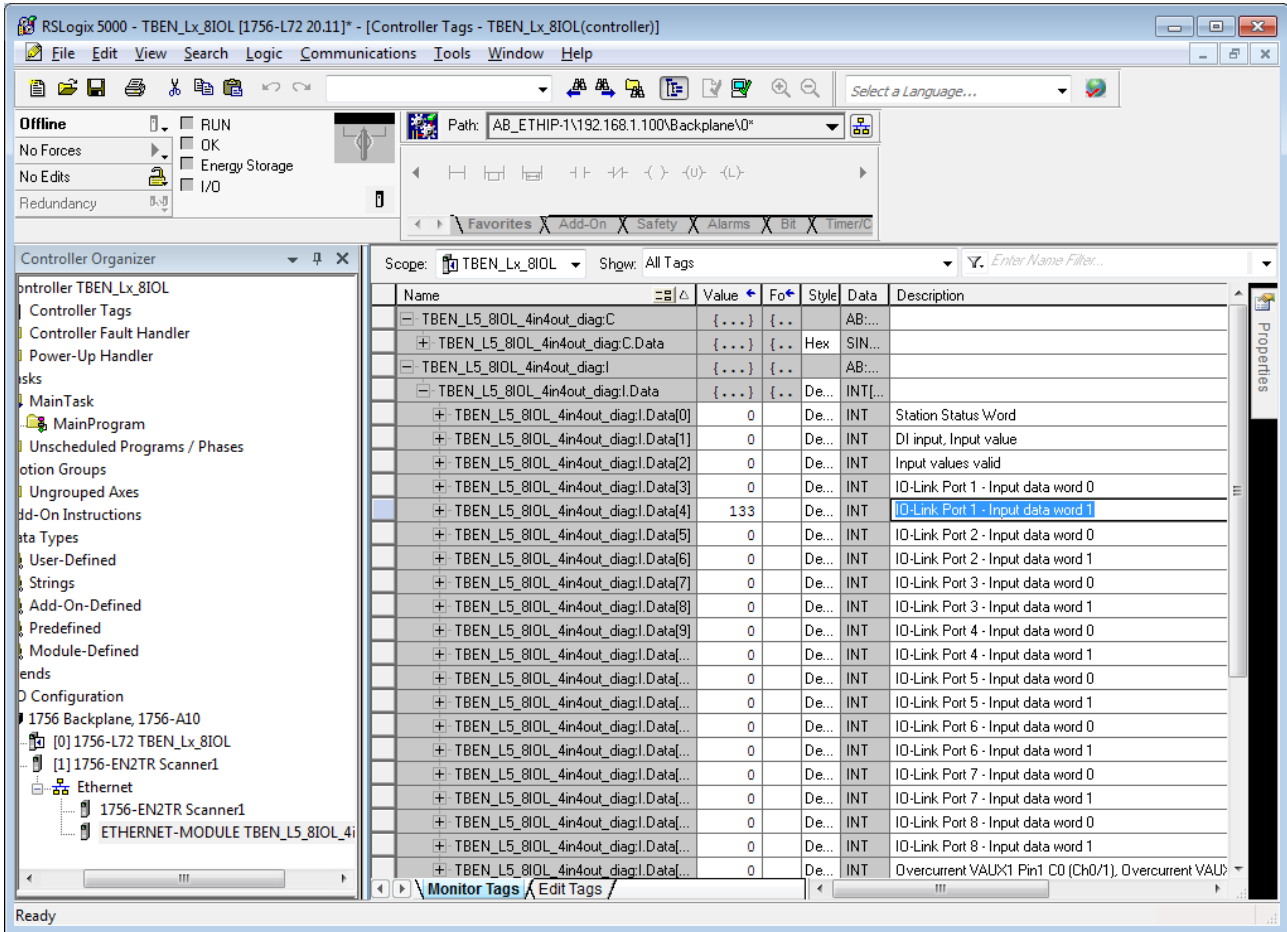

Fig. 57: Controller Tags in the project tree

9 Parameterizing and Configuring

9.1 Parameters

The device has 4 bytes of module parameters, 16 bytes each of IO-Link port parameters and 16 bytes of parameters for VAUX1/VAUX2 monitoring.

Word no.	Bit no.																
	15	14	13	12	11	10	9	8	7	6	5	4	3	2	1	0	
Basic																	
0x00	-	-	-	-	-	-	-	-	-	DXP7_ SRO	-	DXP5_ SRO	-	DXP3_ SRO	-	DXP1_ SRO	-
0x01	-	-	-	-	-	-	-	-	-	DXP7_ EN DO	-	DXP5_ EN DO	-	DXP3_ EN DO	-	DXP1_ EN DO	-
IO-Link port 1																	
0x02	Cycle time								GSD	Activate quick start-up	Data storage mode	Operation mode					
0x03	-								Mapping PCDO	Mapping PDIN	Deactivate diag.	PDIN invalid	Rev.	-			
0x04... 0x05	-								-	-	-	-	-	-	-	-	
0x06	Vendor ID (MSB)								Vendor ID (LSB)								
0x07	Device ID								Device ID (LSB)								
0x08	Device ID (MSB)								Device ID								
0x09	-	-	-	-	-	-	-	-	-	-	-	-	-	-	-	-	-
IO-Link port 2																	
0x0A... 0x11	Assignment similar to IO-Link port 1 (word 0x02...0x09)																
IO-Link port 3																	
0x12... 0x19	Assignment similar to IO-Link port 1 (word 0x02...0x09)																
IO-Link port 4																	
0x1A... 0x21	Assignment similar to IO-Link port 1 (word 0x02...0x09)																
IO-Link port 5																	
0x22... 0x29	Assignment similar to IO-Link port 1 (Word 0x02...0x09)																
IO-Link port 6																	
0x2A... 0x31	Assignment similar to IO-Link port 1 (Word 0x02...0x09)																
IO-Link port 7																	
0x32... 0x39	Assignment similar to IO-Link port 1 (Word 0x02...0x09)																

Word no.	Bit no.															
	15	14	13	12	11	10	9	8	7	6	5	4	3	2	1	0
IO-Link port 8																
0x3A... 0x41	Assignment similar to IO-Link port 1 (Word 0x02...0x09)															
VAUX monitoring																
0x42	-	-	-	-	-	-	VAUX1 pin1 X1 (ch2/3)	-	-	-	-	-	-	-	VAUX1 pin1 X0 (ch0/1)	
0x43	-	-	-	-	-	-	VAUX1 pin1 X3 (ch6/7)	-	-	-	-	-	-	-	VAUX1 pin1 X2 (ch4/5)	
0x44	-	-	-	-	-	-	VAUX1 pin1 X5 (ch10)	-	-	-	-	-	-	-	VAUX1 pin1 X4 (ch8)	
0x45	-	-	-	-	-	-	VAUX1 pin1 X7 (ch14)	-	-	-	-	-	-	-	VAUX1 pin1 X6 (ch12)	
0x46... 0x47	-	-	-	-	-	-	-	-	-	-	-	-	-	-	-	
0x48	-	-	-	-	-	-	VAUX2 pin2 X5 (ch11)	-	-	-	-	-	-	-	VAUX2 pin2 X4 (ch9)	
0x49	-	-	-	-	-	-	VAUX2 pin2 X7 (ch15)	-	-	-	-	-	-	-	VAUX2 pin2 X6 (ch13)	

The default values are shown in **bold type**.

Parameter name	Value		Meaning	Description
	dec.	Hex.		
Manual output re- set after overcur- rent (DXPx_SRO)	0	0x00	Yes	The output switches on automatically after an over- load.
	1	0x01	No	The output is manually switched-off after an overload until a new set-command is given (rise and fall).
Activate output Chx (DXPx_ENDO)	0	0x00	Yes	The output at pin 2 is deactivated.
	1	0x01	No	The output at pin 2 is activated.
Operation mode	0	0x00	IO-Link without valida- tion	Pin 4 is operated in IO-Link mode. The master does not check if the connected device matches the configured one.
	1	0x01	IO-Link with family com- patible device	Pin 4 is operated in IO-Link mode. The master checks if the Vendor ID and the MSB of the Device ID (this byte defines the product family) of the connected device match those of the configured one. If the master detects a mismatch, the IO-Link communication is established, but there is no process data exchange. The device remains in the safe state (Pre-Operate). Parameters and diagnostic information can be read and respectively written.

Parameter name	Value dec.	Hex.	Meaning	Description
	2	0x02	IO-Link with compatible device	Pin 4 is operated in IO-Link mode. The master checks if the Vendor ID and the Device ID of the connected device match those of the configured one. If the Vendor ID matches, but the Device ID not, then the master tries to write the Device ID to the device. If the writing is successful, then the device is a compatible one, process data exchange is possible. If writing the Device ID is not successful, then process data exchange is not possible. The device remains in the safe state (Pre-Operate). Parameters and diagnostic information can be read and respectively written.
	3	0x03	IO-Link with identical device	Pin 4 is operated in IO-Link mode. The master checks if the device type (Vendor ID and Device ID) and the serial number of the connected device match the data of the configured one. If the master detects a mismatch, the IO-Link communication is established, but there is no process data exchange. The device remains in the safe state (Pre-Operate). Parameters and diagnostic information can be read and respectively written.
	4	0x04	DI (with parameter access)	Pin 4 is generally operated as simple digital input. However, an acyclic parameter access from the PLC or the DTM is possible. The IO-Link master starts the port in IO-link mode, parameterizes the device and sets the port back into SIO mode (SI). The port remains in SIO mode (DI) until a new IO-Link request is sent from the higher-level control. Data storage is not supported. Connected devices have to support the SIO mode (DI). In case of a parameter access, the IO-Link communication at the port is started. Switching signals are interrupted.
	8	0x08	DI	Pin 4 is operated as simple digital input. Data storage is not supported.
Data storage mode	Synchronization of parameter data of IO-Link devices (storing the parameter of the connected device in the master). If the synchronization is not possible, a diagnostic message is displayed (DS_ERR). In this case the data memory of the master must be deleted: <ul style="list-style-type: none"> ▶ Select option "11 = deactivated, delete" to delete the data memory of the master IO-Link devices in accordance with IO-Link specification V1.0 do not support data storage. When using IO-Link devices with IO-Link V1.0: <ul style="list-style-type: none"> ▶ Select option "11 = deactivated, delete" to deactivate data storage. 			
	0	0x00	Activated	Synchronization of parameter data activated. The actual data (master or device) serve as the reference data.
	1	0x01	overwrite	Synchronization of parameter data activated, the data in the master serve as reference data.

Parameter name	Value		Meaning	Description
	dec.	Hex.		
	2	0x02	read in	Synchronization of parameter data activated. The data in the connected IO-Link device serve as reference data.
	3	0x03	Deactivated, clear	Synchronization of parameter data deactivated. The data set in the master is deleted.
Activate Quick Start-Up	For fast applications (e.g. tool changing applications) the start-up time of IO-Link devices can be shortened. The start-up time defined in the IO-Link specification (TSD = Device Detection Time) is reduced.			
	0	0x00	No	The start-up time is within the specified range (0.5 s). All IO-Link devices in accordance with the specification can be operated.
	1	0x01	Yes	The start-up time is reduced to approx. 100 ms. It is not supported by every IO-Link device. It can thus be necessary to check if the used IO-Link device starts in this mode.
Device parameterization via GSD (GSD)	0	0x00	inactive	The port is generic or is not parameterized.
	1	0x01	Active	In PROFINET the port is parameterized with a specific device type from the GSDML-file.
Cycle time	0	0x00	Automatic	The lowest cycle time supported by the device is taken from the table.
	16... 191	0x10 ...	1.6...132.8 ms	Settable in steps of 0.8 or 1.6 ms.
	255	0xFF	Automatic, compatible	Compatibility mode The mode solves possible communication problems with sensors of the SGB family from IFM.
Revision	0	0x00	Automatic	The Master defines the IO-Link revision automatically.
	1	0x01	V1.0	IO-Link Revision V 1.0 is used.
Process input data invalid (PDIN invalid)	0	0x00	Diagnostic generated	If the process data are invalid, a respective diagnostic message is generated.
	1	0x01	No diagnostic generated	Invalid process data do not cause a diagnostic message.
Deactivate diagnostics	Influences the sending of IO-Link-Events from the master to the fieldbus. Depending on the parameterization, the master transmits Events based on their priority to the fieldbus or not.			
	0	0x00	No	The master transmits all IO-Link Events to the fieldbus.
	1	0x01	Notifications	The master transmits all IO-Link Events to the fieldbus except for IO-Link notifications.
	2	0x02	Notifications and warnings	The master transmits all IO-Link Events to the fieldbus except for IO-Link notifications and warnings.
	3	0x03	Yes	The master doesn't transmit any IO-Link Event to the fieldbus.

Parameter name	Value		Meaning	Description
	dec.	Hex.		
Process input data mapping (Mapping PDIN)	Optimization of the process data mapping for the used fieldbus: The I/O-Link-data can be swapped depending on the used fieldbus in order to achieve an optimized data mapping on the fieldbus side. PROFINET: With PROFINET, the parameter is permanently set to 0x00 = direct and cannot be changed.			
	0	0x00	direct	The process data are not swapped. i.e.: 0x0123 4567 89AB CDEF
	1	0x01	Swap 16 bit	The bytes are swapped per word. i.e.: 0x2301 6745 AB89 EFCD
	2	0x02	Swap 32 bit	The bytes are swapped per double word. i.e.: 0x6745 2301 EFCD AB89
	3	0x03	swap all	All bytes are swapped. i.e.: 0xEFCD AB89 6745 2301
Process output data mapping (Mapping PDOOUT)	see above Process input data mapping			
Vendor ID	0...65535 0x0000... 0xFFFF		Vendor ID for the port configuration check	
Device ID	0... 16777215 0... 0x00FFFFFF		Device ID for the port configuration check 24 bit value	
VAUX1 pin 1 Xx (chy/chz)	0	0x00	24 VDC	The 24 VDC sensor/actuator supply at pin 1 of the connector is switched on.
	1	0x01	switchable	The 24 VDC sensor/actuator supply at pin 1 of the respective connector is switchable via the process data.
	2	0x02	off	The 24 VDC sensor/actuator supply at pin 1 of the connector is switched off.
VAUX2 pin 2 Xx (chy)	0	0x00	24 VDC	The Class B supply at Pin2 of the respective connector is switched on.
	1	0x01	switchable	The Class B supply at pin 2 of the respective connector is switchable via the process data.
	2	0x02	off	The Class B supply at Pin2 of the respective connector is switched off.

Values for the parameter "cycle time" [ms]:

Time	Value	Time	Value	Time	Value	Time	Value	Time	Value	Time	Value		
auto	0x00	16	0x58	31.2	0x7E	60.8	0x92	91.2	0xA5	121.6	0xB8		
1.6	0x10	16.8	0x5A	32	0x80	62.4	0x93	92.8	0xA6	123.2	0xB9		
2.4	0x18	17.6	0x5C	33.6	0x81	64	0x94	94.4	0xA7	124.8	0xBA		
3.2	0x20	18.4	0x5E	35.2	0x82	65.6	0x95	96	0xA8	126.4	0xBB		
4	0x28	19.2	0x60	36.8	0x83	67.1	0x96	97.6	0xA9	128	0xBC		
4.8	0x30	20	0x62	38.4	0x84	68.8	0x97	99.2	0xAA	129.6	0xBD		
5.6	0x38	20.8	0x67	40	0x85	70.4	0x98	100.8	0xAB	131.2	0xBE		
6.4	0x40	21.6	0x66	41.6	0x86	72	0x99	102.4	0xAC	132.8	0xBF		
7.2	0x42	22.4	0x68	43.2	0x87	73.6	0x9A	104	0xAD	reserved			
8	0x44	23.2	0x6A	44.8	0x88	75.2	0x9B	105.6	0xAE				
8.8	0x46	24.0	0x6C	46.4	0x89	76.8	0x9C	107.2	0xAF				
9.6	0x48	24.8	0x6E	48	0x8A	78.4	0x9D	108.8	0xB0				
10.4	0x4A	25.6	0x70	49.6	0x8B	80	0x9E	110.4	0xB1				
11.2	0x4C	26.4	0x72	51.2	0x8C	81.6	0x9F	112	0xB2				
12.0	0x4E	27.2	0x74	52.8	0x8D	83.2	0xA0	113.6	0xB3				
12.8	0x50	28	0x76	54.4	0x8E	84.8	0xA1	115.2	0xB4				
13.6	0x52	28.8	0x78	56	0x8F	86.4	0xA2	116.8	0xB5				
14.4	0x54	29.6	0x7A	57.6	0x90	88	0xA3	118.4	0xB6				
15.2	1x56	30.4	0x7C	59.2	0x91	89.6	0xA4	120	0xB7			auto., comp.	0xFF

9.1.1 Adapting process data mapping

The mapping of process data can be adapted application-specifically via the IO-Link master's parameterization.

Depending on the used fieldbus, it can be necessary to swap process data word-wise, double word-wise or completely in order to align them to the data structure in the PLC. The process data mapping is determined channel by channel through the parameters **process input data mapping** and **process output data mapping**.

Example mapping for field buses with Little Endian-format:

Mapping through the IO-Link master → field bus → PLC						
Byte	Device at IO-Link port	Device process data in IO-Link master		Parameter: Process data mapping	Device process data to field bus	
Byte 0		Status			Status	
Byte 1		Control			Control	
IO-Link port 1						
Byte 2	Temperature sensor TS...	Temperature	Low byte	swap 16 bit	Temperature	High byte
Byte 3			High byte			Low byte
IO-Link port 2						
Byte 4	Linearity sensor Li...	Position	Low byte	swap 16 bit	position	High byte
Byte 5			High byte			Low byte
IO-Link port 3						
Byte 6	I/O hub TBIL-...	Digital signals	0...7	Direct	Digital signal	0...7
Byte 7		Digital signals	8...15		Digital signal	8...15
IO-Link port 4						
Byte 8		Diagnostics		swap all	Counter/position value	Most Significant Byte
Byte 9	Rotary encoder RI...	Counter/position value	Low byte			High byte
Byte 10			High byte			Low byte
Byte 11			Most Significant Byte		Diagnostics	

9.1.2 PROFINET parameters

For PROFINET, a distinction must be made in the parameters between the PROFINET device parameters and the parameters of the I/O channels Parameters_TBEN_S2-4IOL .

PROFINET device parameters

Default values are shown in **bold**.

Parameter name	Value	Meaning	Description
Output behavior at communication loss	0	set to 0	The device switches the outputs to "0". No error information sent.
	1	Hold current value	The device maintains the actual output data.
Deactivate all diagnostics	0	No	Diagnostic and alarm messages are generated.
	1	yes	Diagnostic and alarm messages are suppressed.
Deactivate load voltage diagnostics	0	No	The monitoring of voltage V2 is activated.
	1	yes	If V2 is undershot, this is not displayed.
Deactivate Force Mode	0	No	Explicit deactivation of the Ethernet protocols or web server
	1	yes	
Deactivate EtherNet/IP	0	No	
	1	yes	
Deactivate Modbus TCP	0	No	
	1	yes	
Deactivate WEB server	0	No	
	1	yes	

9.2 IO-Link functions for acyclic communication

The acyclic access to the data of IO-Link devices is realized via IO-Link CALLs. A distinction must be made between data of the IO-Link master (IOLM) and data of connected IO-Link devices (IOLD).

The addressing of the IO-Link CALL defines which device is addressed via the CALL:

The addressing is defined by the so called Entity_Port:

- Entity_Port 0 = IO-Link master module (IOLM)
- Entity_Port 1 = IO-Link device at IO-Link port 1
- ...
- Entity_Port 8 = IO-Link device at IO-Link port 8

9.2.1 Port functions for Port 0 (IO-Link Master)

IO-Link Index (port function invocation)

The access to the IO-Link master functionalities (port 0) is done via index 65535:

Subindex 64: Master Port Validation Configuration

The object writes a specific configuration of the Devices to be connected to the IO-Link port to the Master. The master stores the data for the The IO-Link device expected at the port and then accepts only one device at the port with exactly matching data (vendor ID, device ID and serial number).

The Master Port Validation Configuration is only useful in combination with an operation mode with validation (**IO-Link with family compatible device, IO-Link with compatible device, IO-Link with identical device.**

Entity_Port	IO-Link sub index	Read/write	Length
0	64	Write	Max. 192 byte

Structure of the command IOL_Port_Config:

	Content	Size	Format	Comment
IOL1	VENDOR_ID	2 byte	Unsigned 16	
	DEVICE_ID	4 byte	Unsigned 32	
	FUNCTION_ID	2 byte	Unsigned 16	Value: 0
	SERIAL_NUMBER	16 byte	String	
IOL2	VENDOR_ID	2 byte	Unsigned 16	
	DEVICE_ID	4 byte	Unsigned 32	
	FUNCTION_ID	2 byte	Unsigned 16	Value: 0
	SERIAL_NUMBER	16 byte	String	
IOL3	VENDOR_ID	2 byte	Unsigned 16	
	DEVICE_ID	4 byte	Unsigned 32	
	FUNCTION_ID	2 byte	Unsigned 16	Value: 0
	SERIAL_NUMBER	16 byte	String	
IOL4	VENDOR_ID	2 byte	Unsigned 16	
	DEVICE_ID	4 byte	Unsigned 32	
	FUNCTION_ID	2 byte	Unsigned 16	Value: 0
	SERIAL_NUMBER	16 byte	String	
IOL5	VENDOR_ID	2 byte	Unsigned 16	
	DEVICE_ID	4 byte	Unsigned 32	
	FUNCTION_ID	2 byte	Unsigned 16	Value: 0
	SERIAL_NUMBER	16 byte	String	
IOL6	VENDOR_ID	2 byte	Unsigned 16	
	DEVICE_ID	4 byte	Unsigned 32	
	FUNCTION_ID	2 byte	Unsigned 16	Value: 0
	SERIAL_NUMBER	16 byte	String	

	Content	Size	Format	Comment
IOL7	VENDOR_ID	2 byte	Unsigned 16	
	DEVICE_ID	4 byte	Unsigned 32	
	FUNCTION_ID	2 byte	Unsigned 16	Value: 0
	SERIAL_NUMBER	16 byte	String	
IOL7	VENDOR_ID	2 byte	Unsigned 16	
	DEVICE_ID	4 byte	Unsigned 32	
	FUNCTION_ID	2 byte	Unsigned 16	Value: 0
	SERIAL_NUMBER	16 byte	String	

Subindex 65: IO-Link Events

The object reads IO-Link Event diagnostics.

Entity_Port	IO-Link sub index	Read/write	Length
0	65	Read	255 byte



NOTE

Only "appears" (coming diagnostics) and "Single Shot Events" are shown, as long as they are pending.

Structure of the read data:

- Byte 0 contains 2 bit per IO-Link port which show, if the process data of the connected device are valid or not.
- Byte 0 is followed by 4 byte per Diagnostic Event which clearly assign and specify the diagnostic message. A maximum of 14 Events per IO-Link port are shown.

Byte no.	Bit no.								Description
	7	6	5	4	3	2	1	0	
0								x	PD_Valid Input Port 1
							x		PD_Valid Output Port 1
						x			PD_Valid Input Port 2
				x					PD_Valid Output Port 2
			x						PD_Valid Input Port 3
		x							PD_Valid Output Port 3
		x							PD_Valid Input Port 4
	x								PD_Valid Output Port 4
1								x	PD_Valid Input Port 5
							x		PD_Valid Output Port 5
						x			PD_Valid Input Port 6
				x					PD_Valid Output Port 6
			x						PD_Valid Input Port 7
		x							PD_Valid Output Port 7
		x							PD_Valid Input Port 8
	x								PD_Valid Output Port 8

Byte no.	Bit no.								Description
	7	6	5	4	3	2	1	0	
2	Qualifier								Defines the type of the event (Warning, Notification, Single Shot Event, etc.) in accordance with IO-Link specification „IO-Link Interface and System“.
3	Port								
4	Event Code high byte								High or- low byte of the error code sent
5	Event Code low byte								
...									...
223	Qualifier								see byte 2 - 5
224	Port								
225	Event Code high byte								
226	Event Code low byte								

Subindex 66: Set Default Parameterization

Writing this object sets the IO-Link master back to factory settings. Any parameter setting and configuration is overwritten. The data storage buffer is deleted as well.

Entity_Port	IO-Link sub index	Read/write	Length
0	66	Write	4 byte

Structure of the reset command:

Byte 3	Byte 2	Byte 1	Byte 0
0xEF	0xBE	0xAD	0xDE

Subindex 67: Teach Mode

The master reads all data (device-Id, vendor-ID, serial number, etc.) from the connected device and saves them. All all previously saved device data are overwritten.

Entity_Port	IO-Link sub index	Read/write	Length
0	67	Write	1 byte

Structure of the Teach command:

Byte 0	
0x00	Teach all ports
0x01	Teach port 1
0x02	Teach port 2
0x03	Teach port 3
0x04	Teach port 4
0x05	Teach port 5
0x06	Teach port 6
0x07	Teach port 7
0x08	Teach port 8
0x09...0xFF	reserved

Subindex 68: Master Port Scan Configuration

The object reads the configuration of the IO-Link devices connected to the IO-Link master.

28 byte are returned per IO-Link port.

Entity_Port	IO-Link sub index	Read/write	Length
0	68	Read	Max. 120 byte

Structure of the response telegram:

IO-Link port	Content	Length	Format	Description
Port 1	Vendor ID	2 byte	UINT16	Vendor ID of the connected device
	Device ID	4 byte	UINT32	Device ID of the connected device
	Function ID	2 byte	UINT16	reserved
	Serial Number	16 byte	UINT8	Serial number of the connected device
	COM_Revision	1 byte	UINT8	IO-Link version
	Proc_In_Length	1 byte	UINT8	Process input data length of the connected device
	Proc_Out_Length	1 byte	UINT8	Process output data length of the connected device
	Cycle time	1 byte	UINT8	Cycle time of the connected device
Port 2... port 8	Structure similar to port 1			

Subindex 69: Extended Port Diagnostics

The object reads the Extended Port Diagnostics.

Entity_Port	IO-Link sub index	Read/write	Length
0	68	Read	Max. 120 byte

Structure of the Extended Port Diagnostics:

Byte no.	Bit no.							
	7	6	5	4	3	2	1	0
0	NO_SIO	TCYC	-	-	DS_F	NO_DS	-	-
1	-	WD	MD	PDI_H	-	-	NO_PD	-
2	-	-	-	-	-	-	-	-
3	Device status according to IO-Link specification							

Diagnostic bit	Meaning
NO_DS	The parameterized port mode does not support data storage. Remedy: ■ Change the parameterization of the port.

Diagnostic bit	Meaning
DS_F	<p>Error in the data storage, synchronization not possible</p> <p>Possible causes:</p> <ul style="list-style-type: none"> ■ Connected device does not support data storage ■ Overflow of the data storage buffer <p>Remedy:</p> <ul style="list-style-type: none"> ▶ Connect a device that supports data storage. ▶ Clear the data storage buffer. ▶ Deactivate the data storage.
TCYC	<p>The device does not support the cycle time parameterized in the master.</p> <p>Remedy:</p> <ul style="list-style-type: none"> ▶ Increase the cycle time set in the master.
NO_SIO	<p>The device does not support the standard DI (SIO) mode.</p> <p>Remedy:</p> <ul style="list-style-type: none"> ▶ Select the IO-Link mode for this port.
NO_PD	<p>No process data available The connected device is not ready for operation.</p> <p>Remedy:</p> <ul style="list-style-type: none"> ▶ Check the configuration.
PDI_E	<p>The connected device reports invalid process data in accordance with IO-Link specification V1.0.</p>
PDI_H	<p>The connected device reports invalid process data in accordance with IO-Link specification V1.1.</p>
MD	<p>Missing device, no IO-Link device detected.</p> <p>Remedy:</p> <ul style="list-style-type: none"> ■ Check the IO-Link cable. ■ Change the device.
WD	<p>Wrong device detected: one or more parameters of the connected device (Vendor ID, Device ID, serial number) does not/do not match the data which are stored in the master for this device.</p> <p>Remedy:</p> <ul style="list-style-type: none"> ■ Change the device. ■ Adapt the master parameterization

Device status

Value	Meaning
0	Device works correctly
1	Maintenance event
2	Out-of-specification event
3	Functional check
4	Error
5...255	reserved

10 Operating



CAUTION

Hot surface at full load and high ambient temperatures

Burn risk

- ▶ Avoid touching the device without additional protection.

10.1 Process input data

Word no.	Bit no.															
	15	14	13	12	11	10	9	8	7	6	5	4	3	2	1	0
Basic																
0x00	-	DI14 (SIO)	-	DI12 (SIO)	-	DI10 (SIO)	-	DI8 (SIO)	DXP7	DI6 (SIO)	DXP5	DI4 (SIO)	DXP3	DI2 (SIO)	DXP1	DI0 (SIO)
0x01	-	DVS1 4	-	DVS1 2	-	DVS1 0	-	DVS8	-	DVS6	-	DVS4	-	DVS2	-	DVS0
IO-Link process input data																
0x02 ... 0x11	IO-Link port 1, structure depends on the channel parameterization (0...32 byte per channel)															
0x12 ... 0x21	IO-Link port 2, structure depends on the channel parameterization (0...32 byte per channel)															
0x22 ... 0x31	IO-Link port 3, structure depends on the channel parameterization (0...32 byte per channel)															
0x32 ... 0x41	IO-Link port 4, structure depends on the channel parameterization (0...32 byte per channel)															
0x42 ... 0x51	IO-Link port 5, structure depends on the channel parameterization (0...32 byte per channel)															
0x52 ... 0x61	IO-Link port 6, structure depends on the channel parameterization (0...32 byte per channel)															
0x62 ... 0x71	IO-Link port 7, structure depends on the channel parameterization (0...32 byte per channel)															
0x72 ... 0x81	IO-Link port 8, structure depends on the channel parameterization (0...32 byte per channel)															
Diagnostics																
	VAUX1/VAUX2															
0x82	VERR V2 X7 Ch15	VERR V2 X6 Ch13	VERR V2 X5 Ch11	VERR V2 X4 Ch9	-	-	-	-	VERR V1 X7 Ch14	VERR V1 X6 Ch12	VERR V1 X5 Ch10	VERR V1 X4 Ch08	VERR V1 X3 Ch6C h7	VERR V1 X2 Ch4C h5	VERR V1 X1 Ch2C h3	VERR V1 X0 Ch0C h1
	DXP channels															

Word no.	Bit no.															
	15	14	13	12	11	10	9	8	7	6	5	4	3	2	1	0
0x83	-	-	-	-	-	-	-	-	ERR DXP 7	-	ERR DXP 5	-	ERR DXP 3	-	ERR DXP 1	-
	IO-Link port 1															
0x84	GEN-ERR	OVL	VHIG H	VLOW W	ULVE	LLVU	OTM P	PRME RR	EVT1	EVT2	PDIN V	HWE RR	DSER R	CFGE RR	PPE	-
0x85	IO-Link port 2, assignment similar to port 1															
0x86	IO-Link port 3, assignment similar to port 1															
0x87	IO-Link port 4, assignment similar to port 1															
0x88	IO-Link port 5, assignment similar to port 1															
0x89	IO-Link port 6, assignment similar to port 1															
0x8A	IO-Link port 7, assignment similar to port 1															
0x8B	IO-Link port 8, assignment similar to port 1															
IO-Link Events																
0x8C	Port (1st Event)								Qualifier (1st Event)							
0x8D	Event Code low byte (1st Event)								Event Code high byte (1st Event)							
...																
0xAA	Port 16th Event)								Qualifier (16th Event)							
0xAB	Event Code low byte (16th Event)								Event Code high byte (16th Event)							
Module status (status word)																
0xAC	-	FCE	-	-	-	COM	V1	-	V2	-	-	-	-	-	-	DIAG

Meaning of process data bits

Name	Value	Meaning
I/O data		
DIx	Digital input x	
	0	No signal at DI (pin 4, SIO)
	1	Signal at DI (pin 4, SIO)
DXPx	configurable digital channel (DXP channel)	
	0	No input signal at DXP-channel (pin 2)
	1	Input signal at DXP-channel (pin 2)
DVSx	Input value valid (Data Valid Signal)	
	0	The IO-Link data are invalid. Possible causes: <ul style="list-style-type: none"> ■ Sensor supply is below the admissible range. ■ IO-Link port is parameterized as simple digital input. ■ No device connected to the master. ■ No input data received from the connected device (only valid for devices with an input data length > 0). ■ No reaction from the connected device to the sending of output data (only valid for devices with an output data length > 0). ■ The connected device sends an process input data invalid error.
	1	The IO-Link data are valid.

Name	Value	Meaning
IO-Link process input data		Process input data of the connected device The order of the IO-Link process input data can be changed via the parameter Process input data mapping .
Diagnostics	[▶ 131]	
IO-Link Events	[▶ 123]	
Module status	[▶ 132]	

10.2 Process output data

Word no.	Bit no.															
	15	14	13	12	11	10	9	8	7	6	5	4	3	2	1	0
Basic																
0x00	-	-	-	-	-	-	-	-	DXP7	-	DXP5	-	DXP3	-	DXP1	-
IO-Link process output data																
0x01 ... 0x10	IO-Link port 1, structure depends on the channel parameterization (0...32 byte per channel)															
0x11 ... 0x20	IO-Link port 2, structure depends on the channel parameterization (0...32 byte per channel)															
0x21 ... 0x30	IO-Link port 3, structure depends on the channel parameterization (0...32 byte per channel)															
0x31 ... 0x40	IO-Link port 4, structure depends on the channel parameterization (0...32 byte per channel)															
0x41 ... 0x50	IO-Link port 5, structure depends on the channel parameterization (0...32 byte per channel)															
0x51 ... 0x60	IO-Link port 6, structure depends on the channel parameterization (0...32 byte per channel)															
0x61 ... 0x70	IO-Link port 7, structure depends on the channel parameterization (0...32 byte per channel)															
0x71 ... 0x80	IO-Link port 8, structure depends on the channel parameterization (0...32 byte per channel)															
VAUX1/VAUX2																
0x81	VAUX 2 pin2 X7 (ch15)	VAUX 2 pin2 X6 (ch13)	VAUX 2 pin2 X5 (ch11)	VAUX 2 pin2 X4 (ch9)	-	-	-	-	VAUX1 pin1 X7 (ch14)	VAUX1 pin1 X6 (ch12)	VAUX1 pin1 X5 (ch10)	VAUX1 pin1 X4 (ch8)	VAUX1 pin1 X3 (ch6/7)	VAUX1 pin1 X2 (ch4/5)	VAUX1 pin1 X1 (ch2/3)	VAUX1 pin1 X0 (ch0/1)

Name	Value	Meaning
I/O data		
DXPx	DXP output	
	0	Output inactive
	1	Output active, max. output current 2 A
VAUX1 Pin1 Xx (chy/chz)	0	The 24 VDC sensor/actuator supply at Pin1 of the connector is switched off.
	1	The 24 VDC sensor/actuator supply at Pin1 of the connector is switched on.
VAUX2 Pin2 Xx (chy/chz)	0	The Class B supply at Pin2 of the connector is switched off.
	1	The Class B supply at Pin2 of the connector is switched on.

10.3 LED displays

The device has the following LED indicators:

- Power supply
- Group and bus errors
- Status
- Diagnostics

LED BUS	Meaning
Off	No voltage connected
Green	Active connection to a master
Flashing green 3x in 2s	ARGEE/FLC active
Green flashing (1 Hz)	Device is ready for operation
Red	IP address conflict, Restore mode active, F_Reset active or Modbus connection timeout
Red flashing	Wink command active
Red/green (1 Hz)	Autonegotiation and/or waiting for DHCP-/BootP-address assignment

LED ERR	Meaning
Off	No voltage connected
Green	No diagnostics
Red	Diagnostic message pending

NOTE: The Ethernet ports XF1 and XF2 each have an LED L/A.

LED L/A	Meaning
Off	No Ethernet connection
Green	Ethernet connection established, 100 Mbps
Yellow	Ethernet connection established, 10 Mbps
Green flashing	Ethernet traffic, 100 Mbps
Yellow blinking	Ethernet traffic, 10 Mbps

LED IOL 0, 2, 4, 6, 8, 10, 12, 14 (IO-Link port 1...8)	Meaning (Channel in IO-Link-mode)
Off	Port inactive, no IO-Link communication, diagnostics deactivated

LED IOL 0, 2, 4, 6, 8, 10, 12, 14	
Meaning (Channel in IO-Link-mode)	
(IO-Link port 1...8)	
Green flashing	IO-Link communication, process data valid
Red flashing	IO-Link communication active and module error, invalid process data
red	IO-Link supply error free, no IO-Link communication and/ or module error, process data invalid

LED IOL 0, 2, 4, 6, 8, 10, 12, 14	
Meaning (channel in SIO mode (DI))	
(IO-Link port 1...8)	
off	No input signal
Green	Digital input signal active

LED IOL 9, 11, 13, 15	
Meaning	
(IO-Link Class B ports 4...8)	
Off	VAUX2 at Pin 2 inactive
Green	VAUX2 at Pin 2 active
Red	VAUX2 at Pin 2 active, overload/short-circuit at VAUX2
Red flashing	Overcurrent supply VAUX1

LED DXP 1, 3, 5, 7	Meaning (input)	Meaning (output)
Off	Input not active	Output not active
Green	Input active	Output active (max. 2 A)
Red	–	Output active with overload/short circuit

10.4 Software diagnostic messages

The device provides the following software diagnostic messages:

- V1/V2 overcurrent diagnostics
Overcurrent diagnostics for the sensor-/ actuator supply VAUX1 and the Class B supply VAUX2
- IO-Link master diagnostics
The IO-Link-master reports problems within the IO-Link communication.
- IO-Link device diagnostics
The device diagnostics map the IO-Link Event Codes (according to the IO-Link specification) sent from the IO-Link devices to the diagnostic telegram of the master.
Event Codes can be read from the connected devices by using appropriate device tools (e.g. IODD-Interpreter).
Further information concerning the IO-Link Event Codes and their meaning can be found in the IO-Link specification or in the documentation of the connected devices.

10.4.1 Status- and control word

Status word

EtherNet/IP/ Modbus	PROFINET	Bit 7	Bit 6	Bit 5	Bit 4	Bit 3	Bit 2	Bit 1	Bit 0
Byte 0	Byte 1	V2	-	-	-	-	-	ARGEE	DIAG
Byte 1	Byte 0	-	FCE	-	-	-	COM	V1	-

Bit	Description
COM	Internal error The device-internal communication is disturbed.
DIAG	Diagnostic messages at the device
FCE	The DTM Force Mode is activated, which means, the actual output values may no match the ones defined and sent by the field bus.
V1	V1 or V2 too low (< 18 V DC).
V2	

The status word is mapped into the module's process data.

In EtherNet/IP the mapping can be deactivated via the Gateway Class (VSC 100).



NOTE

Activating or deactivating the status and control word modifies the process data mapping.

Control word

The control word has no function.

10.4.2 Diagnostic telegram

Channel	Byte no.	Bit 7	Bit 6	Bit 5	Bit 4	Bit 3	Bit 2	Bit 1	Bit 0
V1/V2		V1/V2 overcurrent diagnostics							
	0	VERR V1 X7 ch14	VERR V1 X6 ch12	VERR V1 X5 ch10	VERR V1 X4 ch08	VERR V1 X3 ch6ch7	VERR V1 X2 ch4ch5	VERR V1 X1 ch2ch3	VERR V1 X0 ch0ch1
	1	VERR V 2 X7 ch15	VERR V2 X6 ch13	VERR V2 X5 ch11	VERR V2 X4 ch9	-	-	-	-
DXP		DXP diagnostics							
	0	ERR DXP7	-	ERR DXP5	-	ERR DXP3	-	ERR DXP1	-
	1	-	-	-	-	-	-	-	-
IO-Link		Device diagnostic messages				Master diagnostics			
IO-Link port 1	0	EVT1	EVT2	PD INV	HW_ ERR	DS ERR	CFG ERR	PPE	-
	1	GEN ERR	OLV	VHIGH	VLOW	ULVE	LLVU	OTEMP	PRM ERR
IO-Link port 2	2...3	Assignment similar to IO-Link port 1							
...	...								
IO-Link port 8	14...15								



NOTE

The “process data” invalid diagnostic (PDINV) can be sent from both devices, IO-Link master or IO-Link device.

Meaning of diagnostic Bits

Bit	Meaning
V1/V2 overcurrent diagnostics	
VErrV1 Xx	Overcurrent VAUX1 (pin1) at connector/channel group chy/chz
VErrV1 Xxchy	Overcurrent VAUX1 (pin 1) at connector/channel
VErrV2 Xxchy	Overcurrent VAUX2 (pin 2) at connector/channel
IO-Link master diagnostics	
CFGER	Wrong or missing device The connected device does not match the channel configuration or there is no device connected to the channel. This diagnostic message depends on the parameterization of the channel.
DSER	Data storage error Possible causes: <ul style="list-style-type: none"> ■ Data storage mismatch: IO-Link device in accordance with IO-Link V1.0 connected. The data storage buffer contains data of another device. ■ Overflow of the data storage buffer ■ The connected device may be locked for parameter changes or for data storage.

Bit	Meaning
PPE	<p>Port parameterization</p> <p>The port parameters are inconsistent. The device parameterization via GSD is active, but not working.</p> <p>Possible causes:</p> <ul style="list-style-type: none"> ■ The IO-Link-master did not receive GSDML-parameters for a connected device. The connected device was not parameterized by a PROFINET PLC via GSDML. ■ The port is in operation mode "IO-Link without validation" or "DI". These modes do not allow parameterization via GSDL file. ■ Data storage mode is active. The parameter is not set to "deactivated, clear". A device parameterization via GSDML is not possible with activated data storage. ■ Vendor or Device ID are "0". The connected device can not be identified and is thus not parameterizable.
IO-Link master/device diagnostics	
PDINV	<p>Evaluating Process Input Data</p> <p>The IO-Link master or the IO-Link device report invalid process input data. The connected device is not in status "operate", which means, it is not ready for operation.</p> <p>Possible sources:</p> <ul style="list-style-type: none"> ■ The connected device does not match the configured one, additional diagnostic message Wrong or missing device. ■ Diagnostic message Process input data invalid because the process value can not be measured (depends on the IO-Link device).
IO-Link device diagnostics	
	<p>The IO-Link device diagnostics depend on the IO-Link device used. For more detailed information on the diagnoses, please refer to the documentation for the IO-Link device.</p>
EVT1	<p>Maintenance events</p> <p>A Maintenance Event in accordance with the IO-Link specification occurred, maintenance necessary.</p>
EVT2	<p>Out-of-specification events</p> <p>An Out-of-Specification Event in accordance with the IO-Link specification occurred.</p>
GENERR	<p>Common error</p> <p>The device sends an error (device status 4, in accordance with IO-Link specification), which is not clearly specified. Read out the device Event Codes in order to be able to specify the error more precisely.</p>
HWER	<p>Hardware error</p> <p>General hardware error or device malfunction of the connected device</p>
LLVU	<p>Lower limit value underrun</p> <p>The process value lies under the parameterized measurement range or the chosen measurement range has been chosen too high.</p>
OLV	<p>Overload</p> <p>The connected device detected an overload.</p>
OTMP	<p>Overtemperature</p> <p>A temperature diagnosis is available on the connected device.</p>
PRMERR	<p>Parameterization error</p> <p>The connected device reports a parameterization error (loss of parameters, no parameter initialization, etc.).</p>

Bit	Meaning
ULVE	Upper limit value exceeded The process value exceeds the parameterized measurement range or the chosen measurement range has been chosen too low.
VLOW	Undervoltage One of the voltages at the connected device is below the defined range.
VHIGH	Overvoltage One of the voltages at the connected device is below the defined range.

10.4.3 PROFINET diagnostics

Module diagnostics (slot 0 according to configuration tool)		PROFINET Diagnostics	
	Connector	Error code	Channel
Undervoltage V1	-	0x0002	0
Undervoltage V2	-	0x0002	1

DXP diagnostics (slot 1 according to configuration tool)		PROFINET Diagnostics		
	Channel	Connector	Error code	Channel
Overcurrent output	DXP1	X0	0x0001	1
	DXP3	X1	0x0001	3
	DXP5	X2	0x0001	5
	DXP7	X3	0x0001	7

VAUX1/VAUX2 diagnostics (slot 1, according ot configuration tool)		PROFINET Diagnostics	
		Error code	Channel
Overcurrent VAUX1 (pin 1) at X0, channel 0/1		0x01D0	0
Overcurrent VAUX1 (pin 1) at X1, channel 2/3		0x01D1	
Overcurrent VAUX1 (pin 1) at X2, channel 4/5		0x01D2	
Overcurrent VAUX1 (pin 1) at X3, channel 6/7		0x01D3	
Overcurrent VAUX1 (pin 1) at X4, channel 8		0x01E8	
Overcurrent VAUX1 (pin 1) at X5, channel 10		0x01EA	
Overcurrent VAUX1 (pin 1) at X6, channel 12		0x01EC	
Overcurrent VAUX1 (pin 1) at X7, channel 14		0x01EE	
Overcurrent VAUX2 (pin 2) at X4, channel 9		0x01F9	
Overcurrent VAUX2 (pin 2) at X5, channel 12		0x01FB	
Overcurrent VAUX2 (pin 2) at X6, channel 14		0x01FD	
Overcurrent VAUX2 (pin 2) at X7, channel 9		0x01FF	

IO-Link port diagnostics		PROFINET Diagnostics	
IO-Link port 1 (Slot 2, according to configuration tool)	Connector	Error code	Channel
Undervoltage (VLOW)	X0	0x0002	0
Overcurrent (VHIGH)		0x0003	
Overload (OVL)		0x0004	
Over temperature (OTMP)		0x0005	
Wrong or missing device (CFGERR)		0x0006	
Upper limit value exceeded (ULVE)		0x0007	
Lower limit value underrun (LLVU)		0x0008	
Data storage error (DSER)		0x0009	
Process input data invalid (PDINV)			
Maintenance events (EVT1)			
Out of specification error (EVT2)			
Port parameterization error (PPE)			
Parameterization error (PRMER)		0x0010	
Hardware error (HWERR)		0x0010	
IO-Link port 2 (Slot 3, according to configuration tool)			
Similar to port 1	X1		2
IO-Link port 3 (Slot 4, according to configuration tool)			
Similar to port 1	X2		4
IO-Link port 4 (Slot 5, according to configuration tool)			
Similar to port 1	X3		6
IO-Link port 5 (Slot 6, according to configuration tool)			
Similar to port 1	X4		8
IO-Link port 6 (Slot 7, according to configuration tool)			
Similar to port 1	X5		10
IO-Link port 7 (Slot 8, according to configuration tool)			
Similar to port 1	X6		12
IO-Link port 8 (Slot 9, according to configuration tool)			
Similar to port 1	X7		14

10.5 Using the data storage mode

Data storage mode



NOTE

Data storage mode is only available for devices complying with the IO-Link specification V1.1.

In the IO-Link master, the data storage mode can be set using the parameter "data storage mode".

- 00 = activated
- 01 = overwrite
- 10 = read in
- 11 = deactivated, clear

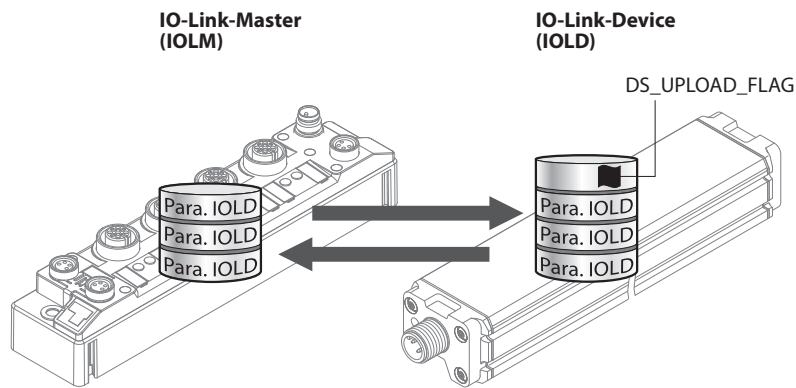

Fig. 58: Data storage mode – general principle, Para. IOLD = parameters of the IO-Link device

A change of parameters in the device is indicated by the status of the DS_UPLOAD_FLAG bit:

- 0 = no changes in the device's parameter set
- 1 = changes in the device's parameter set (e. g. via DTM, at the device, etc.)

10.5.1 Parameter "data storage mode" = activated

The synchronization of the parameter sets is bidirectional.

The actual data set (master or device) is valid:

The following applies:

- The data set in the device is actual, if DS_UPLOAD_FLAG = 1.
- The data set in the Master is actual, if DS_UPLOAD_FLAG = 0.

Use Case 1: Parameterizing the Device Using e.g. a DTM

- ✓ The IO-Link device is already installed in the system and connected to the master.
- ▶ Parameterizing the device via DTM.
- ⇒ DS_UPLOAD_FLAG = 1, parameter set in the device changed.
- ⇒ The parameter data are transferred from the new IO-Link device to the IO-Link master.

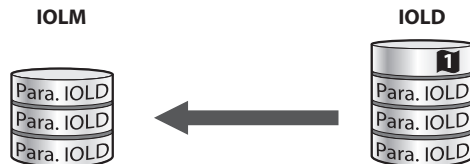

Fig. 59: Data storage mode activated – parameter set in the device changed

Use case 2: replace a defective device with a device in the delivery state.

- ✓ The **new** IO-Link device has **not** been connected to the master before.
- ▶ The parameters of the new device remain unchanged, DS_UPLOAD_FLAG = 0.
- ⇒ The parameter data of the defective device are transferred from the IO-Link master to the new IO-Link device.

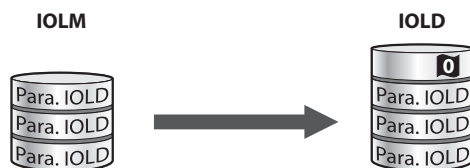

Fig. 60: Data storage mode activated – parameter set in the device unchanged

Use case 3: replace a defective device with a device with unknown (changed) parameters

- ✓ The **new** IO-Link device has **not** been connected to the master before.
- ▶ The parameters of the new device remain unchanged, DS_UPLOAD_FLAG = 1.
- ⇒ The parameter data are transferred from the new IO-Link device to the IO-Link master.

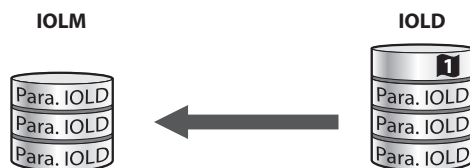

Fig. 61: Data storage mode activated – parameter set in the device changed



NOTE

If device replacement is necessary when data storage is activated, an IO-Link replacement device with unknown parameter data should be reset to its factory settings before connection to the IO-Link master.

Turck IO-Link devices can be reset to factory settings via a system command using a generic IO-Link-DTM and the device-specific IODD. For the reset of third party devices, please read the corresponding manufacturer documentation.

10.5.2 Parameter "data storage mode" = read in

- The data set in the device is **always** the reference data set.
- The synchronization of the parameter sets is unidirectional towards to the master.
- The status of the DS_UPLOAD_FLAG is ignored.

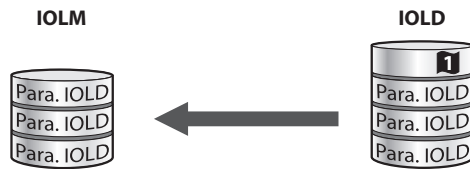

Fig. 62: Data storage mode = read in – parameter set in the device changed

10.5.3 Parameter "data storage mode" = overwrite

- The data set in the master is **always** the reference data set.
- The synchronization of the parameter sets is unidirectional towards to the device.
- The status of the DS_UPLOAD_FLAG is ignored.

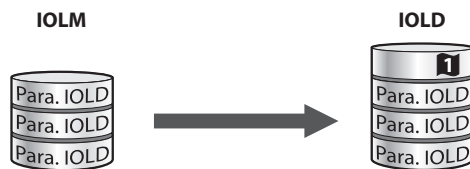

Fig. 63: Data storage mode = overwrite – parameter set in the master changed

10.5.4 Parameter "data storage mode" = deactivated, clear

- The data set in the master is deleted.
- The synchronization of parameter sets is deactivated.



Fig. 64: Data storage mode deactivated – no synchronization

11 Troubleshooting

If the device does not work as expected, proceed as follows:

- ▶ Exclude environmental disturbances.
- ▶ Check the connections of the device for errors.
- ▶ Check device for parameterization errors.

If the malfunction persists, the device is faulty. In this case, decommission the device and replace it with a new device of the same type.

11.1 Eliminate parameterization errors

DXP channels

Error	Possible causes:	Remedy
DXP output does not switch	The output is deactivated per default.	▶ Switch on the output via parameter Activate output (DXP_EN_DO=1).

IO-Link channels

LED behavior	Diagnostics	Possible causes:	Remedy
DIA and IOL flash red	Data storage error	IO-Link device according to IO-Link V1.0 connected IO-Link devices in accordance with IO-Link specification V1.0 do not support data storage.	▶ Set parameter Data storage mode to deactivated, clear . ⇒ Data storage remain deactivated.
		The data storage buffer contains data of another device.	▶ Set parameter Data storage mode to deactivated, clear . ▶ Re-activate the data storage if necessary.
	Wrong or missing device	The connected device does not match the configured one (wrong vendor-ID, device-ID etc.)	▶ Adapt the parameterization of the IO-Link port (Vendor ID, Device ID, etc.) at the master. The parameterization can be done manually via DTM, the web server or similar or by teaching the master using the IO-Link-Call (port 0 function, sub index 67: Teach mode).
Process input data invalid	Certain IO-Link devices send a process input data invalid diagnosis if the process value cannot be measured.	▶ Deactivate the sending of the diagnosis for the IO-Link port with the parameter Process input data invalid → No diagnostic generated .	

12 Maintenance

Ensure that the plug connections and cables are always in good condition.

The devices are maintenance-free, clean dry if required.

12.1 Carry out firmware update via FDT/DTM

The firmware of the device can be updated via FDT/DTM. The PACTware FDT frame application, the DTM for the device and the current firmware are available as downloads free of charge from www.turck.com.



NOTICE

Interruption of the power supply during the firmware update

Risk of device damage due to faulty firmware update

- ▶ Do not interrupt the power supply during the firmware update.
- ▶ During the firmware update do not reset the power supply.

Example: update the firmware with the PACTware FDT frame application

- ▶ Launch PACTware.
- ▶ Right-click **Host PC** → **Add device**.

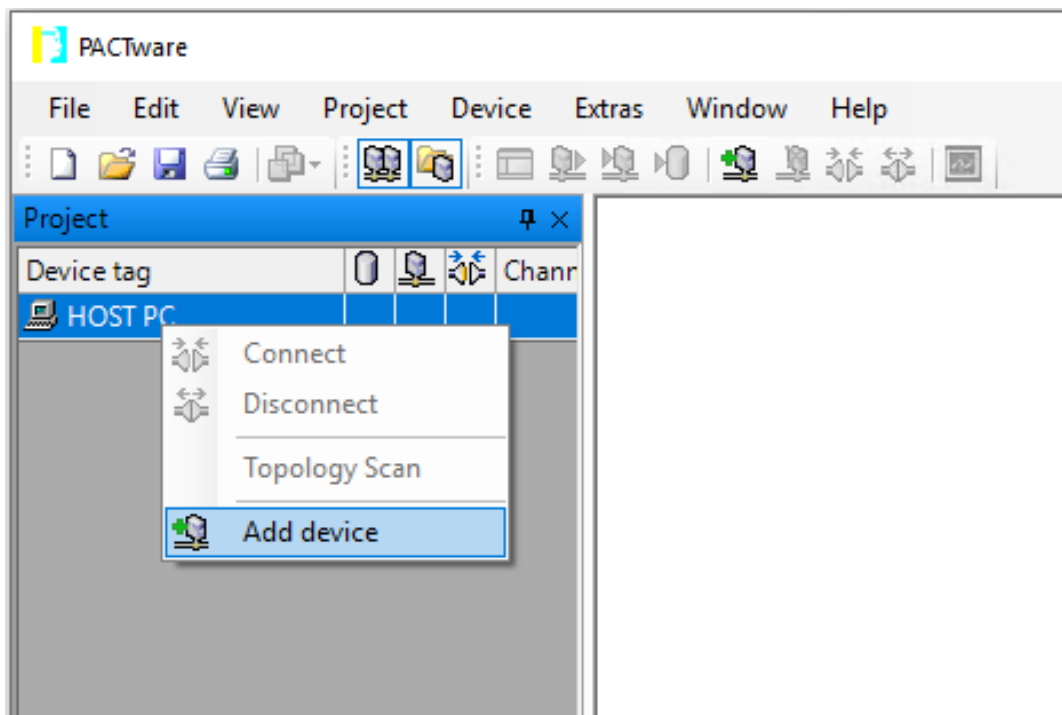

Fig. 65: Adding a Device in PACTware

- ▶ Select **BL Service Ethernet** and confirm with **OK**.

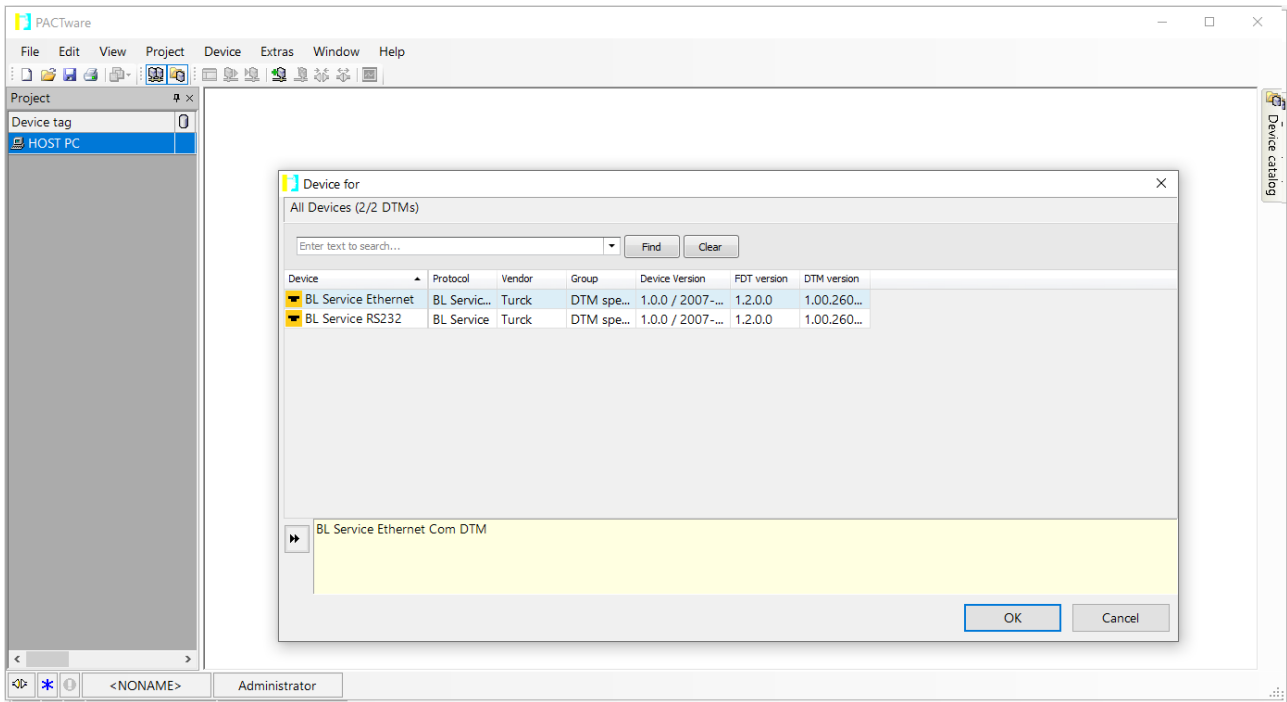

Fig. 66: Selecting the Ethernet interface

- ▶ Double-click the connected device.
- ⇒ PACTware opens the bus address management.

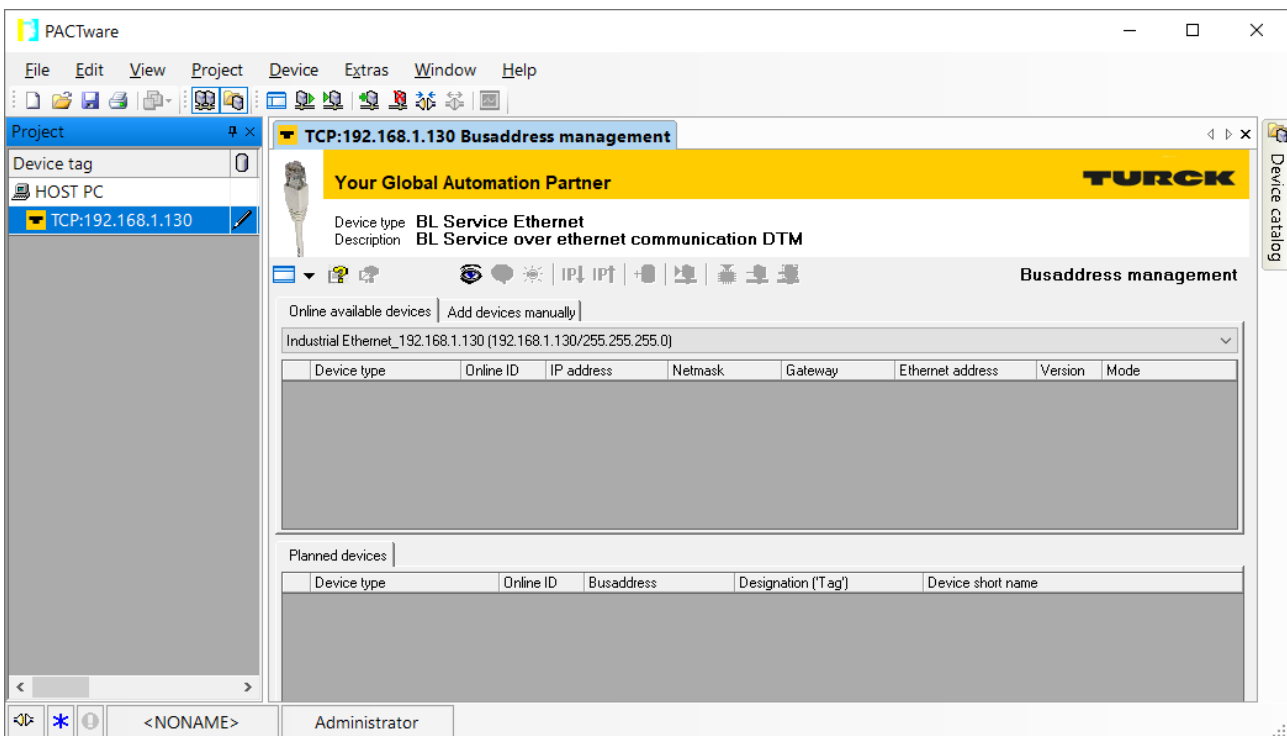

Fig. 67: Opening the busaddress management

- ▶ Search for connected Ethernet devices: Click the **Search** icon.
- ▶ Select the required device.

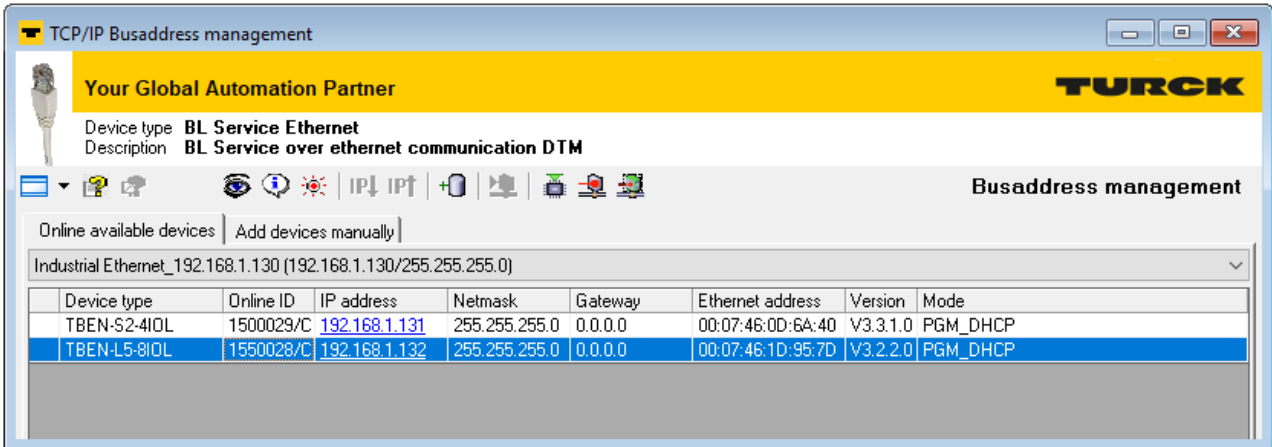

Fig. 68: Selecting the device

- ▶ Click **Firmware Download** to start the firmware update.

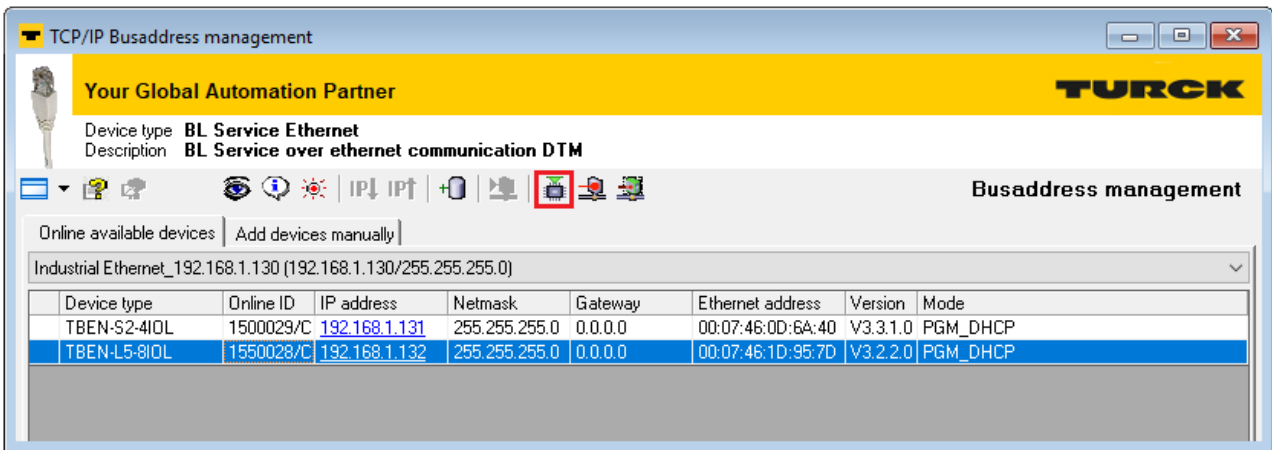

Fig. 69: Starting the firmware update

- ▶ Select the storage location and confirm with **OK**.
- ⇒ PACTware shows the progress of the firmware update with a green bar at the bottom of the screen.

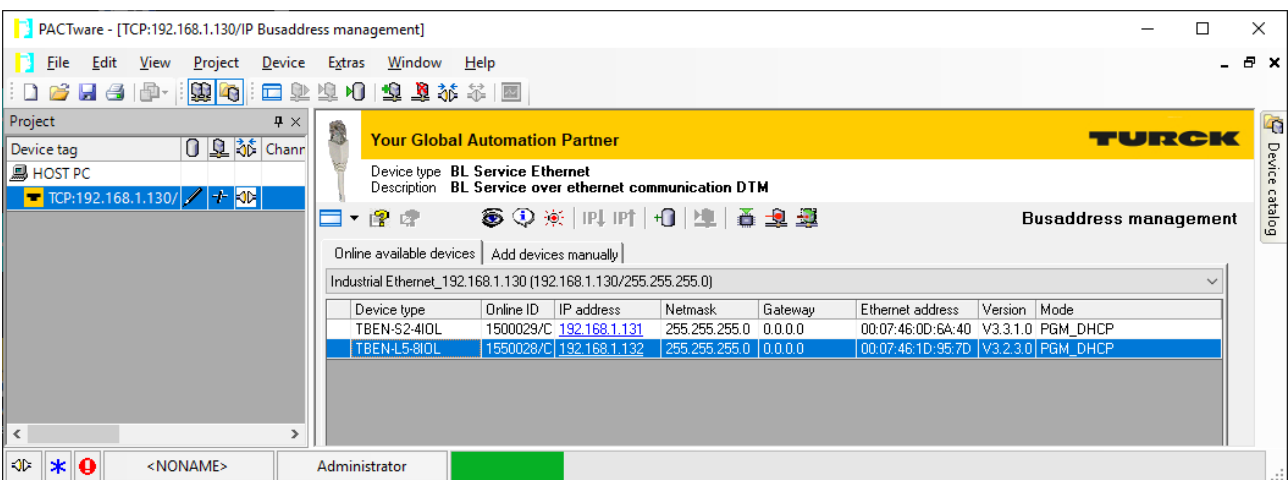

Fig. 70: Firmware update in progress

13 Repair

The device must not be repaired by the user. The device must be decommissioned if it is faulty. Observe our return acceptance conditions when returning the device to Turck.

13.1 Returning devices

Returns to Turck can only be accepted if the device has been equipped with a Decontamination declaration enclosed. The decontamination declaration can be downloaded from <https://www.turck.de/en/retoure-service-6079.php> and must be completely filled in, and affixed securely and weather-proof to the outside of the packaging.

14 Disposal



The devices must be disposed of correctly and must not be included in normal household garbage.

15 Technical data

Technical Data	
Power supply	
Supply voltage	24 VDC
Permissible range	18...30 VDC
<ul style="list-style-type: none"> ■ IO-Link 	<ul style="list-style-type: none"> ■ 20,4 ... 28.8 VDC
Total current	max. 9 A per voltage group V1 + V2: max. 11 A
Power consumption	
Operating current (at 24 VDC nominal voltage) < 120 mA (outputs inactive)	
Operating current (at 28.8...18.0 VDC)	<ul style="list-style-type: none"> ■ V1: 120...180 mA ■ V2: 90...40 mA
Operating conditions:	
<ul style="list-style-type: none"> ■ All outputs active without load ■ Ethernet communication active 	
Sensor/actuator supply V_{AUX1}	Supply from V1 short-circuit proof, max. 4 A per connector X0 und X4, max. 2 A per connector X1...X3, X5...X7
Sensor/actuator supply V_{AUX2}	Class B supply from V2 short-circuit proof, max. 4 A per connector X4...X5 max. 2 A per connector X6...X7
Potential isolation	Galvanic isolation from V1 and V2 voltage group, voltages up to 500 VDC
Connectors	
Ethernet	2 x M12, 4-pin, D coded
Power supply	2 x M12, 5-pin, L coded
Digital in-/outputs	
Permissible torques	
<ul style="list-style-type: none"> ■ Ethernet ■ I/O channels/supply ■ Mounting (M6 screws) 	<ul style="list-style-type: none"> 0.6 Nm 0.8 Nm 1.5 Nm
Isolation voltages	
V1 to V2	≥ 500 V AC
V1/V2 to field bus	≥ 500 V AC
System data	
Transmission rate	10 Mbps/100 Mbps
Fieldbus connection technology	2 x M12, 4-pole, D coded
Protocol detection	Automatic
Web server	Integrated, 192.168.1.254
Service interface	Ethernet via P1 or P2
Field Logic Controller (FLC)	
Supported from firmware version	3.0.6.0
Released as of ARGEE version	2.0.25.0
Modbus TCP	

Technical Data	
Address assignment	Static IP, DHCP
Supported Function Codes	FC1, FC2, FC3, FC4, FC5, FC6, FC15, FC16, FC23
Number of TCP connections	8
Register start address	0 (0x0000)
Register start address	2048 (0x0800)
Lokal port	Port 502, fixed setting
EtherNet/IP	
Address assignment	according to EtherNet/IP standard
Device Level Ring (DLR)	Supported
Quick Connect (QC)	< 150 ms
Number of Class 3 (TCP) connections	3
Number of Class 1 (CIP) connections	10
Input Assembly Instances	103, 120, 121, 122, 123, 124, 125
Output Assembly Instances	104, 150, 151, 152
Configuration Assembly Instance	106
PROFINET	
PROFINET specification	V 2.35
Conformance Class	B (RT)
Address assignment	DCP
MinCycle Time	1 ms
Fast Start-Up (FSU)	< 150 ms
Diagnostics	according to PROFINET Alarm Handling
Topology detection	Supported
Automatic address setting	Supported
Media Redundancy Protocol (MRP)	Supported
System redundancy	S2
Network load class	3
Digital inputs	
Number of channels	4 DXP and 8 SIO
Input type	PNP
Type of input diagnostics	Channel diagnosis
Switching threshold	EN 61131-2 type 3, PNP
Signal voltage, low level	< 5 V
Signal voltage, high level	> 11 V
Low level signal current	< 1.5 mA
High-level signal current	> 2 mA
Input delay	0.05 ms
Potential isolation	Galvanic isolation to P1/P2, voltage proof up to 500 V AC
Digital outputs	
Number of channels	4 DXP
Output type	PNP
Type of output diagnostics	Channel diagnostics

Technical Data	
Output voltage	24 VDC from potential group
Output current per channel	2 A, short-circuit-proof
Potential isolation	Galvanic isolation to P1/P2, voltage proof up to 500 V AC
IO-Link	
Number of channels	8
IO-Link	Pin 4 operated in IO-Link mode
IO-Link specification	Version 1.1
IO-Link port type	Class A at X0...X3 Class B at X4...X7
Frame type	Supports all specified frame types
Supported devices	Max. 32 byte input/32 byte output
■ Input data	■ max. 32 Byte per channel
■ Output data	■ max. 32 Byte per channel
Transmission rate	4,8 kbps (COM 1) 38,4 kbps (COM 2) 230,4 kbps (COM 3)
Transmission cable	Length: max. 20 m standard lines, 3- or 4-wire (depending on the application), unshielded
Mounting	
Type of mounting	Via 2 mounting holes, Ø 6.3 mm
Mounting distance (device to device)	≥ 50 mm Valid for operation in ambient temperatures defined below with sufficient ventilation and maximum load (horizontal nominal position). At ambient temperatures of < 30 °C, the devices can also be mounted directly next to each other.
Standard/Directive conformity	
Vibration test	According to EN 60068-2-6
Acceleration	Up to 20 g
Shock test	According to EN 60068-2-27
Drop and topple	According to IEC 60068-2-31/IEC 60068-2-32
Electro-magnetic compatibility	According to EN 61131-2
Approvals and certificates	CE, FCC
UL cond.	cULus LISTED 21 W2, Encl.Type 1 IND.CONT.EQ.
General information	
Dimensions (B × L × H)	64 × 230.4 × 39 mm
Operating temperature	-40...+70 °C
Storage temperature	-40...+85 °C
Operating height	max. 5000 m
Protection class	IP65/IP67/IP69K
MTTF	160 years acc. to SN 29500 (Ed. 99) 20 °C
Housing material	PA6-GF30

Technical Data	
Housing color	Black
Material window	Lexan
Material label	Polycarbonate
Halogen-free	Yes

FCC declaration



NOTE

This equipment has been tested and found to comply with the limits for a Class A digital device, pursuant to part 15 of the FCC Rules. These limits are designed to provide reasonable protection against harmful interference when the equipment is operated in a commercial environment. This equipment generates, uses, and can radiate radio frequency energy and, if not installed and used in accordance with the instruction manual, may cause harmful interference to radio communications. Operation of this equipment in a residential area is likely to cause harmful interference in which case the user will be required to correct the interference at his own expense.

TURCK

Over 30 subsidiaries and over
60 representations worldwide!

100013018 | 2019/11



www.turck.com