



Brand of NTN corporation

Technical data

1206.C3

Double-row self-aligning ball bearings



Self-aligning ball bearing, pressed steel cage, open

VISUAL (S)

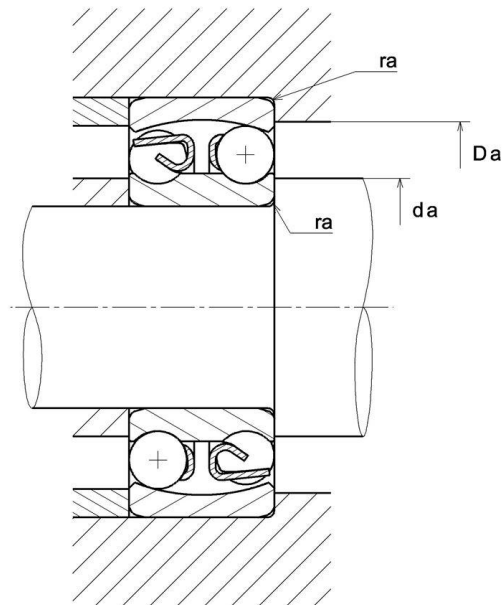
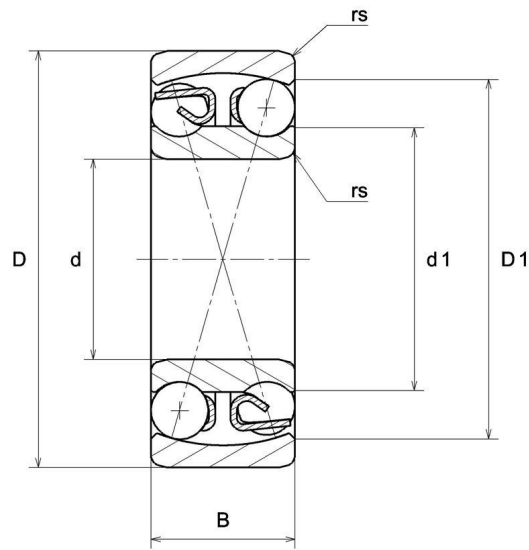

NTN Europe

1 rue des Usines · BP 2017 · 74010 Annecy Cedex · France · Tel. +33 (0)4 50 65 30 00
S.A. au capital de 322 639 919 € · RCS ANNECY B 325 821 072 · Id. Fiscale : FR 48 325 821 072
SIRET 325 821 072 00015 · Code APE 2815 Z · Code NACE 28.15

1206.C3

Double-row self-aligning ball bearings

PRODUCT DEFINITION

Brand	SNR
d - Internal diameter	30 mm
D - External diameter	62 mm
B - Bearing/Inner ring width	16 mm
d1 - External diameter inner ring	40,3 mm
D1 - Inner diameter outer ring	51,5 mm
rs - Min fillet radius	1 mm
Radial clearance class	C3
Precision class	P0
Mass	0,221 kg

PRODUCT PERFORMANCE

C - Dynamic load	15400000 mN
C0 - Static load	4650000 mN
Cu - Fatigue limit load	210000 mN
e - Coefficient	0.24
Y0 - Static axial load coefficient	2.7
Y1 - Lower axial load coefficient	2.57
Y2 - Upper axial load coefficient	3.98
N ref - Reference thermal speed	66000 °/s
N lim - Mechanical Limit Speed	90000 °/s
Tmin - Min operating temperature	233,15 °K
Tmax - Max operating temperature	393,15 °K



NTN Europe

1 rue des Usines · BP 2017 · 74010 Annecy Cedex · France · Tel. +33 (0)4 50 65 30 00
S.A. au capital de 322 639 919 € · RCS ANNECY B 325 821 072 · Id. Fiscale : FR 48 325 821 072
SIRET 325 821 072 00015 · Code APE 2815 Z · Code NACE 28.15

1206.C3

Double-row self-aligning ball bearings

BEARING FREQUENCIES

BPFO - Over rolling frequency on outer ring (60 rpm)	5.792 Hz
BPFI - Over rolling frequency on inner (60 rpm)	8.208 Hz
BSF - Over rolling frequency on rolling element (60 rpm)	5.549 Hz
BRF - Rotational frequency - rolling element (60 rpm)	2.775 Hz
FTF - Rotational frequency - cage (60 rpm)	0.414 Hz

ABUTMENT

da min - Min shoulder diameter IR	35 mm
Da max - Max shoulder diameter OR	57 mm
ra max - Max shaft & housing fillet radius	1 mm



NTN Europe

1 rue des Usines · BP 2017 · 74010 Annecy Cedex · France · Tel. +33 (0)4 50 65 30 00
S.A. au capital de 322 639 919 € · RCS ANNECY B 325 821 072 · Id. Fiscale : FR 48 325 821 072
SIRET 325 821 072 00015 · Code APE 2815 Z · Code NACE 28.15