

Datasheet

RS Pro High Torque Hybrid StepperMotor

Stock No: 535-0489

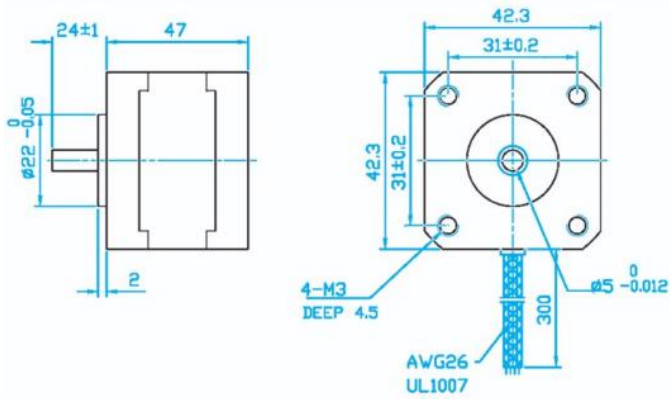

Characteristics

- Resistance Accuracy
± 10%
- Inductance Accuracy
± 20%
- Temperature Rise
80°C max. (rated current, 2 phase on)
- Ambient Temperature
-10°C to +50°C
- Insulation Resistance
100 M Ω min., 500 Vdc
- Dielectric Strength
500 Vac for one minute
- Shaft Radial Play
0.06 max. (450 g-load)
- Shaft Axial Play
0.08 max. (450 g-load)

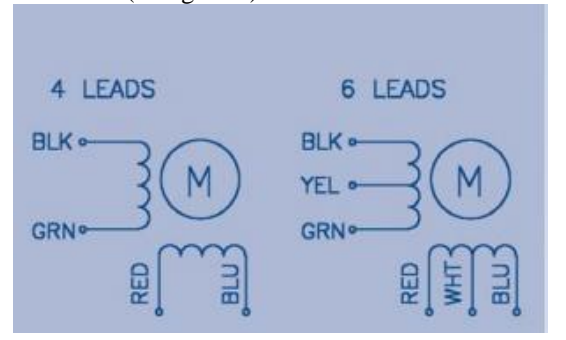

Specifications

Step Angle		1.8
Step Angle Accuracy (Full Step, No Load)	%	±5
Rated Voltage	V	2.8
Current/Phase	A	1.68
Resistance/Phase	Ω	1.65
Inductance/Phase	MH	2.8
Detent Torque	mNm	25
Holding Torque	Ncm	44
Rotor Inertia	G-CM ²	68
Weight	Kg	0.35
Number of Leads	N°.	4