



Alcoswitch | Alcoswitch AV25

TE Internal #: 1-2317656-5

Anti-Vandal Switch, Single Pole - Single Throw Configuration (Pole-Throw), Single Actuator, Flush Actuator, Illuminated, Alcoswitch AV25

[View on TE.com >](#)

Switches > Push Button Switches

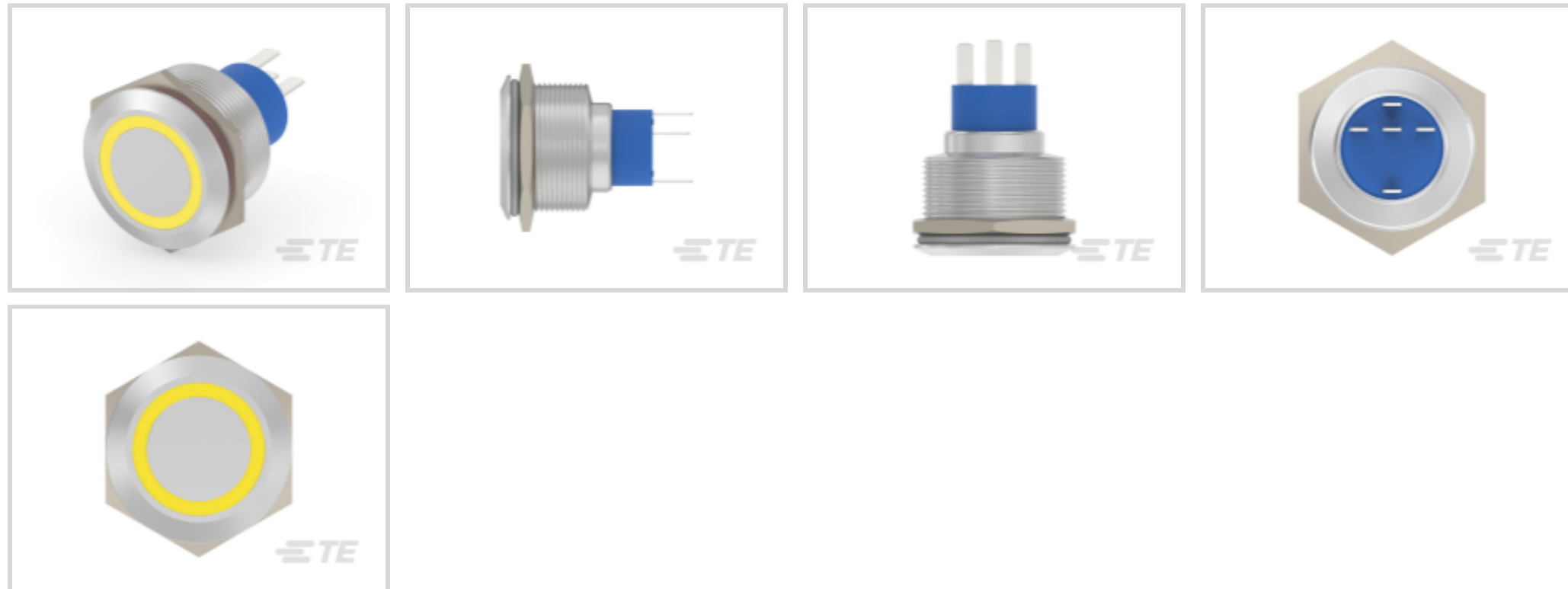

Push Button Switch Product Type: **Anti-Vandal Switch**

Configuration (Pole-Throw): **Single Pole - Single Throw**

Number of Actuators: **Single**

Actuator Profile: **Flush**

Bushing Style: **Threaded**

Features

Product Type Features

Switch Connection Type	Wire Lugs
Push Button Switch Product Type	Anti-Vandal Switch
Illuminated	With
Actuator Style	Round Actuator

Configuration Features

Configuration (Pole-Throw)	Single Pole - Single Throw
Number of Actuators	Single
Snap Action	Without
Support Bracket	Without
Switch Feedback Type	Auditory
Operating Function	On Off

Electrical Characteristics

Contact Current Rating	3 A
Operating Voltage Range	250 VAC

Body Features

Case Material	PBT
Product Orientation	Vertical
Actuator Force	255 g[9 oz]
Actuator Profile	Flush
Bushing Style	Threaded

Contact Features

Contact Base Material	Copper
Switch Contact Plating Material	Silver

Housing Features

Process Sealed	Yes
----------------	-----

Industry Standards

IP Rating	IP67
-----------	------

Product Compliance

[For compliance documentation, visit the product page on TE.com>](#)

EU RoHS Directive 2011/65/EU	Compliant with Exemptions
EU ELV Directive 2000/53/EC	Compliant with Exemptions
China RoHS 2 Directive MIIT Order No 32, 2016	Restricted Materials Above Threshold
EU REACH Regulation (EC) No. 1907/2006	Current ECHA Candidate List: JAN 2025 (247) Candidate List Declared Against: JUNE 2024 (241) SVHC > Threshold: Pb (3.7% in Component Part) Article Safe Usage Statements: Do not eat, drink or smoke when using this product. Wash thoroughly after handling. Recycle if possible and dispose of the article by following all applicable governmental regulations relevant to your geographic location.
Halogen Content	Low Halogen - Br, Cl, F, I < 900 ppm per homogenous material. Also BFR/CFR/PVC Free
Solder Process Capability	Not reviewed for solder process capability

Product Compliance Disclaimer

This information is provided based on reasonable inquiry of our suppliers and represents our current actual knowledge based on the information they provided. This information is subject to change. The part numbers that TE has identified as EU RoHS compliant have a maximum concentration of 0.1% by weight in homogenous materials for lead, hexavalent chromium, mercury, PBB, PBDE, DBP, BBP, DEHP, DIBP, and 0.01% for cadmium, or qualify for an exemption to these limits as defined in the Annexes of Directive 2011/65/EU (RoHS2). Finished electrical and electronic equipment products will be CE marked as required by Directive 2011/65/EU. Components may not be CE marked. Additionally, the part

numbers that TE has identified as EU ELV compliant have a maximum concentration of 0.1% by weight in homogenous materials for lead, hexavalent chromium, and mercury, and 0.01% for cadmium, or qualify for an exemption to these limits as defined in the Annexes of Directive 2000/53/EC (ELV). Regarding the REACH Regulation, the information TE provides on SVHC in articles for this part number is based on the latest European Chemicals Agency (ECHA) 'Guidance on requirements for substances in articles' posted at this URL: <https://echa.europa.eu/guidance-documents/guidance-on-reach>

Compatible Parts



TE Part # 2317659-4
AV25 SPM 3A MOVING RING POWER R&B 24V FL



TE Part # 2328820-1
AV 25 SPM 3A MOVING RING R&G 12V



TE Part # 2317655-2
AV25 SPL 3A NO LED FL



TE Part # 2328818-1
AV25 SPM 3A MOVING RING WHITE 12V



TE Part # 2317656-9
AV25 SPM 3A MOVING RING BLUE 12V

Also in the Series | Alcoswitch AV25

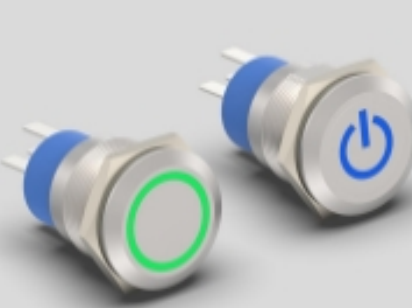

Anti-Vandal Switches(88)

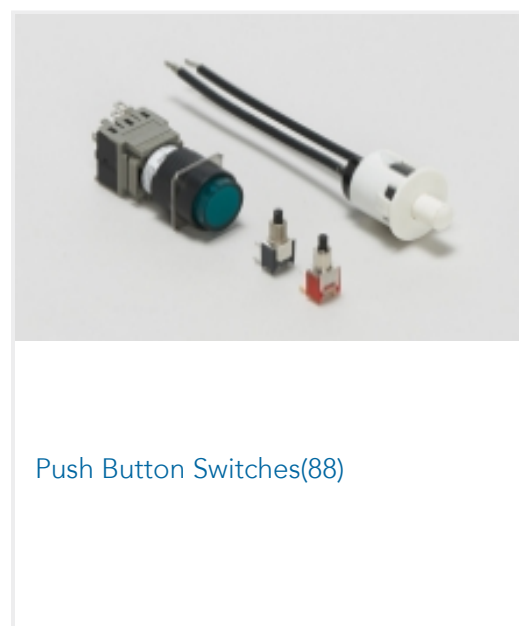

Push Button Switches(88)

Customers Also Bought



TE Part #114017-ZZ
SEALING PLUG, SIZE 12/16, WHT



TE Part #CAT-AM71-CH8172
AMP SUPERSEAL 1.5MM, CONNECTOR HOUSING

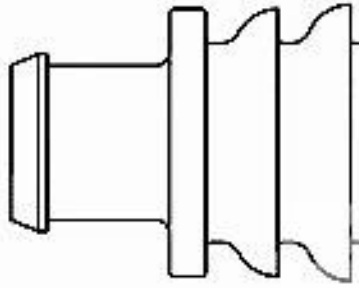

TE Part #281934-2
SINGLE WIRE SEAL



TE Part #CAT-D48-ST273
DEUTSCH Solid Contacts



Documents

CAD Files

[3D PDF](#)

3D

Customer View Model

[ENG_CVM_CVM_1-2317656-5_A.2d_dxf.zip](#)

English

Customer View Model

[ENG_CVM_CVM_1-2317656-5_A.3d_igs.zip](#)

English

Customer View Model

[ENG_CVM_CVM_1-2317656-5_A.3d_stp.zip](#)

English

By downloading the CAD file I accept and agree to the [Terms and Conditions](#) of use.

Datasheets & Catalog Pages

[ALCOSWITCH Anti-Vandal Switch](#)

English

Agency Approvals

[UL Report](#)

English