



FDMS86163P

P-Channel PowerTrench[®] MOSFET

-100 V, -50 A, 22 mΩ

Features

- Max $r_{DS(on)}$ = 22 mΩ at $V_{GS} = -10$ V, $I_D = -7.9$ A
- Max $r_{DS(on)}$ = 30 mΩ at $V_{GS} = -6$ V, $I_D = -5.9$ A
- Very low RDS-on mid voltage P-channel silicon technology optimised for low Qg
- This product is optimised for fast switching applications as well as load switch applications
- 100% UIL tested
- RoHS Compliant



General Description

This P-Channel MOSFET is produced using Fairchild Semiconductor's advanced PowerTrench[®] process that has been especially tailored to minimize the on-state resistance and yet maintain superior switching performance.

Applications

- Active Clamp Switch
- Load Switch

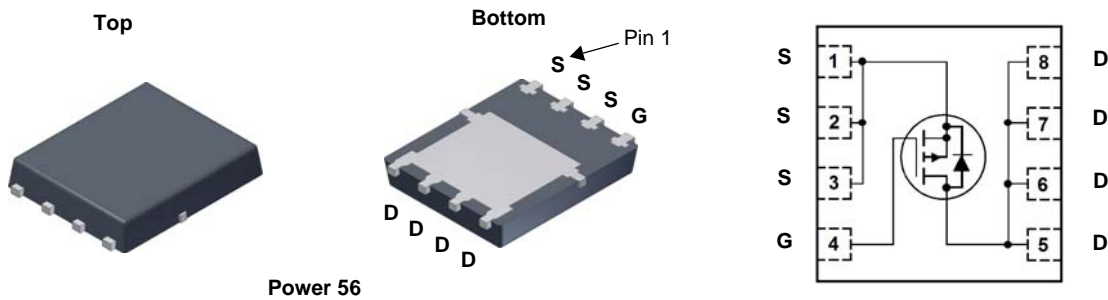

MOSFET Maximum Ratings $T_A = 25$ °C unless otherwise noted

Symbol	Parameter	Rated	Units
V_{DS}	Drain to Source Voltage	-100	V
V_{GS}	Gate to Source Voltage	±25	V
I_D	Drain Current -Continuous	$T_C = 25$ °C	A
	-Continuous	$T_A = 25$ °C (Note 1a)	
	-Pulsed	(Note 4)	
E_{AS}	Single Pulse Avalanche Energy	(Note 3)	mJ
P_D	Power Dissipation	$T_C = 25$ °C	W
	Power Dissipation	$T_A = 25$ °C (Note 1a)	
T_J, T_{STG}	Operating and Storage Junction Temperature Range	-55 to +150	°C

Thermal Characteristics

$R_{\theta JC}$	Thermal Resistance, Junction to Case	1.2	°C/W
$R_{\theta JA}$	Thermal Resistance, Junction to Ambient (Note 1a)	50	

Package Marking and Ordering Information

Device Marking	Device	Package	Reel Size	Tape Width	Quantity
FDMS86163P	FDMS86163P	Power 56	13 "	12 mm	3000 units

Electrical Characteristics $T_J = 25\text{ }^\circ\text{C}$ unless otherwise noted

Symbol	Parameter	Test Conditions	Min	Typ	Max	Units
--------	-----------	-----------------	-----	-----	-----	-------

Off Characteristics

BV_{DSS}	Drain to Source Breakdown Voltage	$I_D = -250\text{ }\mu\text{A}, V_{GS} = 0\text{ V}$	-100			V
$\frac{\Delta BV_{DSS}}{\Delta T_J}$	Breakdown Voltage Temperature Coefficient	$I_D = -250\text{ }\mu\text{A}$, referenced to $25\text{ }^\circ\text{C}$		-59		mV/ $^\circ\text{C}$
I_{DSS}	Zero Gate Voltage Drain Current	$V_{DS} = -80\text{ V}, V_{GS} = 0\text{ V}$			-1	μA
I_{GSS}	Gate to Source Leakage Current	$V_{GS} = \pm 25\text{ V}, V_{DS} = 0\text{ V}$			± 100	nA

On Characteristics

$V_{GS(th)}$	Gate to Source Threshold Voltage	$V_{GS} = V_{DS}, I_D = -250\text{ }\mu\text{A}$	-2	-2.8	-4	V
$\frac{\Delta V_{GS(th)}}{\Delta T_J}$	Gate to Source Threshold Voltage Temperature Coefficient	$I_D = -250\text{ }\mu\text{A}$, referenced to $25\text{ }^\circ\text{C}$		6.2		mV/ $^\circ\text{C}$
$r_{DS(on)}$	Static Drain to Source On Resistance	$V_{GS} = -10\text{ V}, I_D = -7.9\text{ A}$		17.8	22	m Ω
		$V_{GS} = -6\text{ V}, I_D = -5.9\text{ A}$		21.3	30	
		$V_{GS} = -10\text{ V}, I_D = -7.9\text{ A}, T_J = 125\text{ }^\circ\text{C}$		29	36	
g_{FS}	Forward Transconductance	$V_{DS} = -10\text{ V}, I_D = -7.9\text{ A}$		29		S

Dynamic Characteristics

C_{iss}	Input Capacitance	$V_{DS} = -50\text{ V}, V_{GS} = 0\text{ V},$ $f = 1\text{ MHz}$		3070	4085	pF
C_{oss}	Output Capacitance			501	670	pF
C_{riss}	Reverse Transfer Capacitance			21	35	pF
R_g	Gate Resistance		0.1	2.6	5.3	Ω

Switching Characteristics

$t_{d(on)}$	Turn-On Delay Time	$V_{DD} = -50\text{ V}, I_D = -7.9\text{ A},$ $V_{GS} = -10\text{ V}, R_{GEN} = 6\text{ }\Omega$		17	30	ns	
t_r	Rise Time			8.8	18	ns	
$t_{d(off)}$	Turn-Off Delay Time			33	53	ns	
t_f	Fall Time			6.9	14	ns	
Q_g	Total Gate Charge		$V_{GS} = 0\text{ V to } -10\text{ V}$		42	59	nC
Q_g	Total Gate Charge	$V_{GS} = 0\text{ V to } -6\text{ V}$	$V_{DD} = -50\text{ V},$ $I_D = -7.9\text{ A}$		26	37	nC
Q_{gs}	Gate to Source Charge				11.8		nC
Q_{gd}	Gate to Drain "Miller" Charge				7.1		nC

Drain-Source Diode Characteristics

V_{SD}	Source to Drain Diode Forward Voltage	$V_{GS} = 0\text{ V}, I_S = -7.9\text{ A}$ (Note 2)		-0.81	-1.3	V
		$V_{GS} = 0\text{ V}, I_S = -2\text{ A}$ (Note 2)		-0.75	-1.2	
t_{rr}	Reverse Recovery Time	$I_F = -7.9\text{ A}, di/dt = 100\text{ A}/\mu\text{s}$		63	102	ns
Q_{rr}	Reverse Recovery Charge			132	210	nC

Notes:

- $R_{\theta JA}$ is determined with the device mounted on a 1 in² pad 2 oz copper pad on a 1.5 x 1.5 in. board of FR-4 material. $R_{\theta JC}$ is guaranteed by design while $R_{\theta CA}$ is determined by the user's board design.

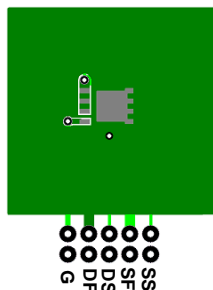

a) $50\text{ }^\circ\text{C/W}$ when mounted on a 1 in² pad of 2 oz copper

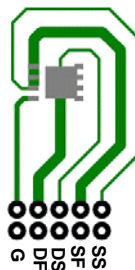

b) $125\text{ }^\circ\text{C/W}$ when mounted on a minimum pad of 2 oz copper.

2. Pulse Test: Pulse Width < 300 μs , Duty cycle < 2.0%.

3. Starting $T_J = 25\text{ }^\circ\text{C}$; P-ch: L = 3 mH, $I_{AS} = -18\text{ A}$, $V_{DD} = -100\text{ V}$, $V_{GS} = -10\text{ V}$. 100% test at L = 0.1 mH, $I_{AS} = -58\text{ A}$.

4. Pulse Id refers to Figure.11 Forward Bias Safe Operation Area.

Typical Characteristics $T_J = 25\text{ }^\circ\text{C}$ unless otherwise noted

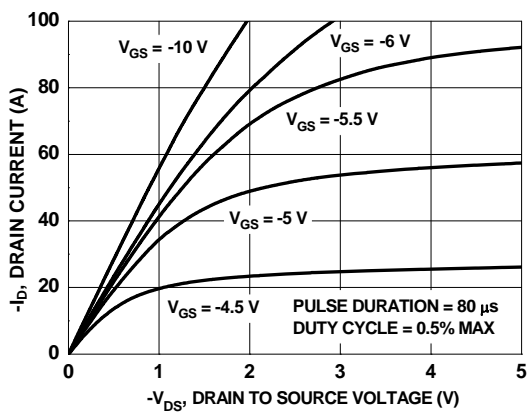

Figure 1. On Region Characteristics

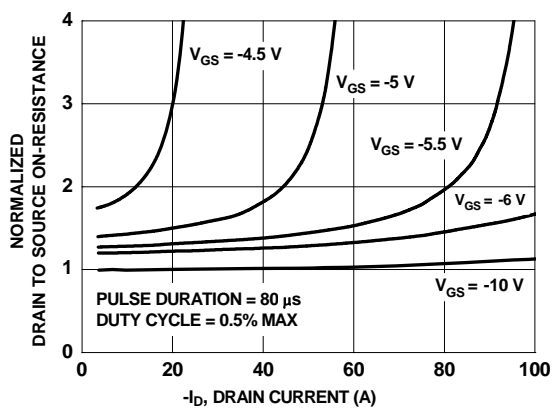

Figure 2. Normalized On-Resistance vs Drain Current and Gate Voltage

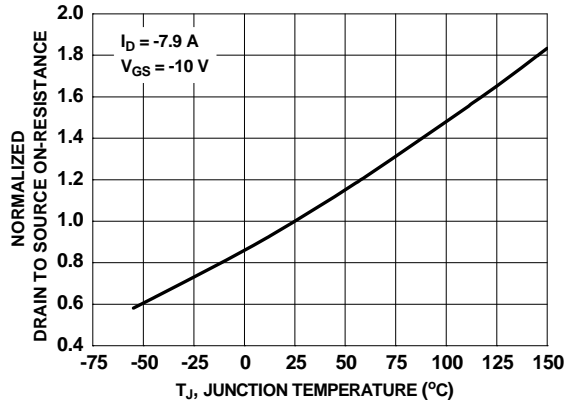

Figure 3. Normalized On Resistance vs Junction Temperature

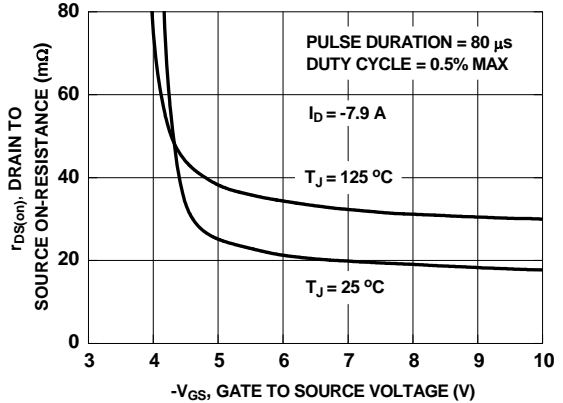

Figure 4. On-Resistance vs Gate to Source Voltage

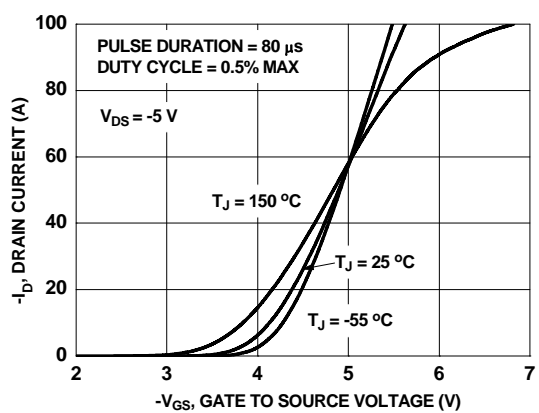

Figure 5. Transfer Characteristics

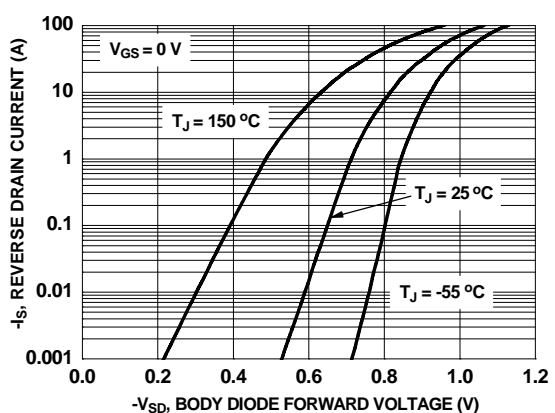

Figure 6. Source to Drain Diode Forward Voltage vs Source Current

Typical Characteristics $T_J = 25\text{ }^\circ\text{C}$ unless otherwise noted

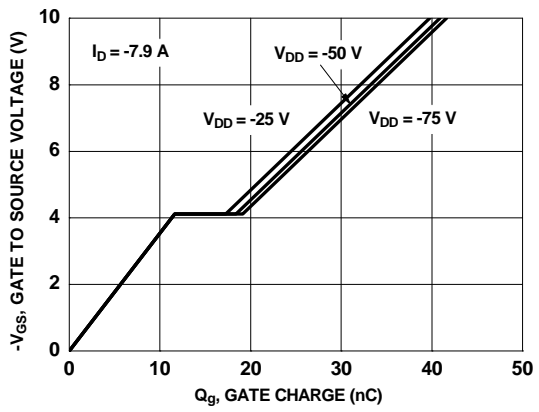

Figure 7. Gate Charge Characteristics

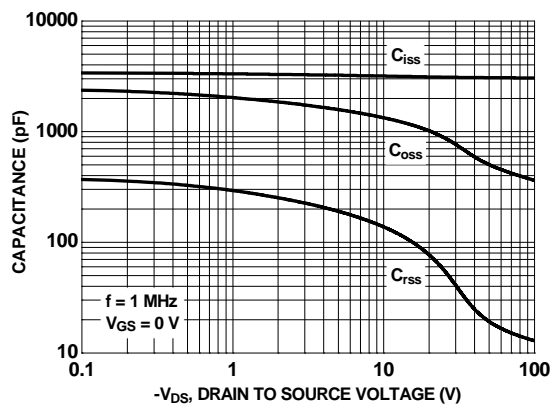

Figure 8. Capacitance vs Drain to Source Voltage

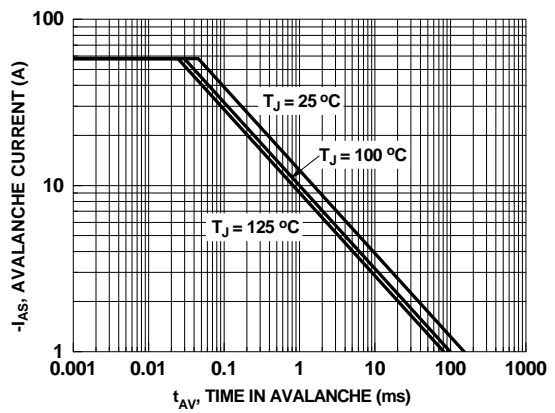

Figure 9. Unclamped Inductive Switching Capability

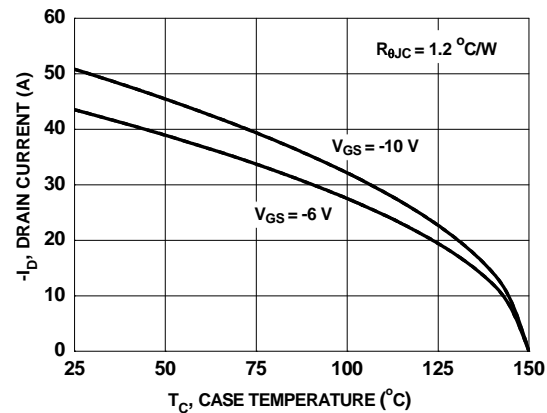

Figure 10. Maximum Continuous Drain Current vs Case Temperature

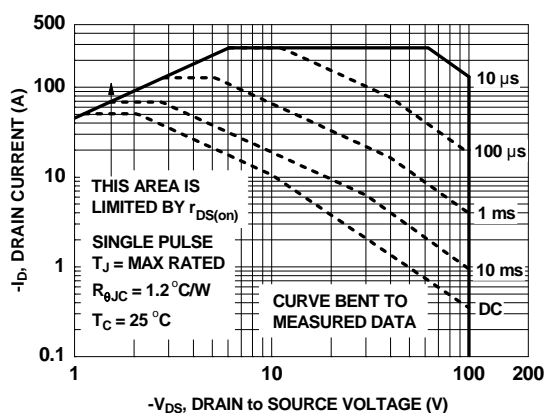

Figure 11. Forward Bias Safe Operating Area

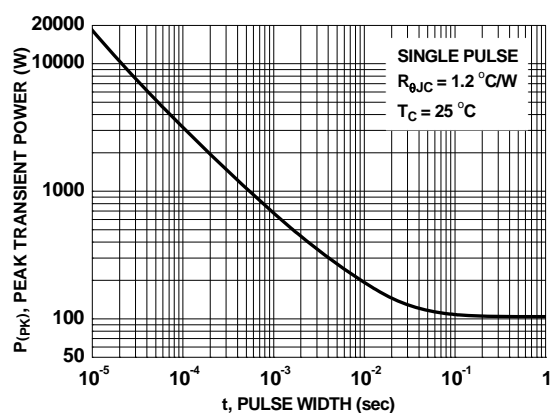

Figure 12. Single Pulse Maximum Power Dissipation

Typical Characteristics $T_J = 25\text{ }^\circ\text{C}$ unless otherwise noted

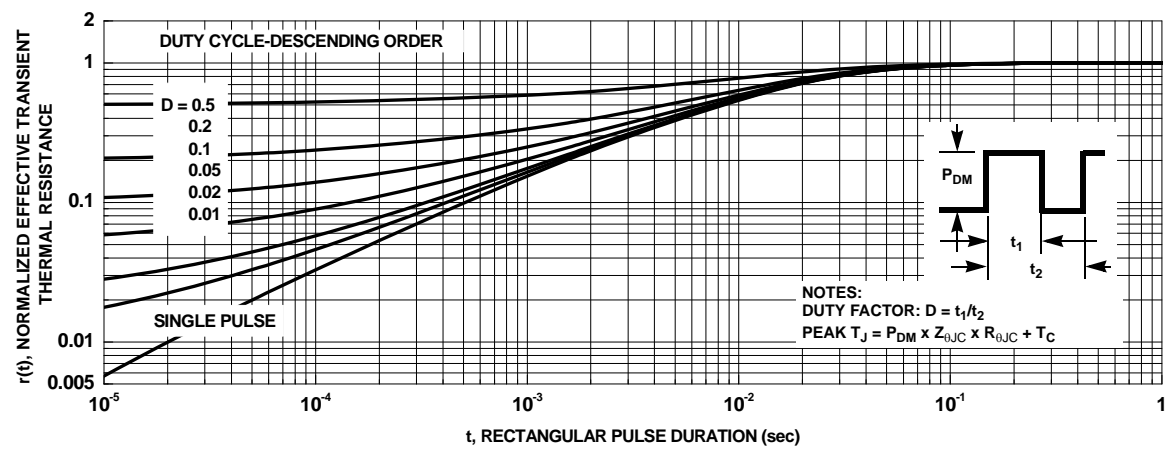
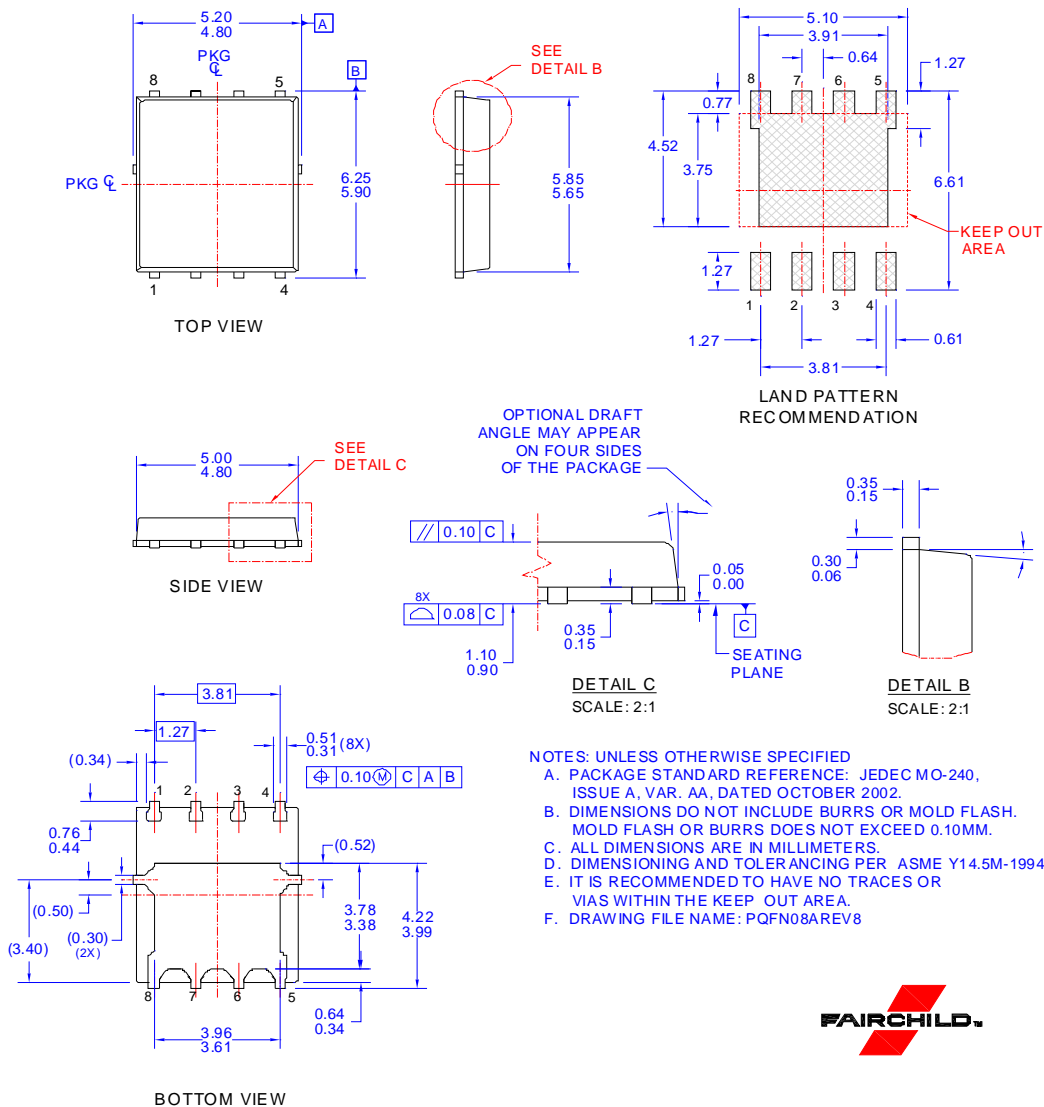

Figure 13. Junction-to-Case Transient Thermal Response Curve

Dimensional Outline and Pad Layout



- NOTES: UNLESS OTHERWISE SPECIFIED
- A. PACKAGE STANDARD REFERENCE: JEDEC MO-240, ISSUE A, VAR. AA, DATED OCTOBER 2002.
 - B. DIMENSIONS DO NOT INCLUDE BURRS OR MOLD FLASH. MOLD FLASH OR BURRS DOES NOT EXCEED 0.10MM.
 - C. ALL DIMENSIONS ARE IN MILLIMETERS.
 - D. DIMENSIONING AND TOLERANCING PER ASME Y14.5M-1994.
 - E. IT IS RECOMMENDED TO HAVE NO TRACES OR VIAS WITHIN THE KEEP OUT AREA.
 - F. DRAWING FILE NAME: PQFN08AREV8







Package drawings are provided as a service to customers considering Fairchild components. Drawings may change in any manner without notice. Please note the revision and/or date on the drawing and contact a Fairchild Semiconductor representative to verify or obtain the most recent revision. Package specifications do not expand the terms of Fairchild's worldwide terms and conditions, specifically the warranty therein, which covers Fairchild products.

Always visit Fairchild Semiconductor's online packaging area for the most recent package drawings:
https://www.fairchildsemi.com/evaluate/package-specifications/packageDetails.html?id=PN_PQOAM-008



TRADEMARKS

The following includes registered and unregistered trademarks and service marks, owned by Fairchild Semiconductor and/or its global subsidiaries, and is not intended to be an exhaustive list of all such trademarks.

- | | | | |
|---|---|---|---|
| AccuPower™ | F-PFS™ |  | SYSTEM GENERAL® |
| Awinda® | FRFET® | PowerTrench® | TinyBoost® |
| AX-CAP®* | Global Power Resource™ | PowerXST™ | TinyBuck® |
| BitSiC™ | GreenBridge™ | Programmable Active Droop™ | TinyCalc™ |
| Build it Now™ | Green FPS™ | QFET® | TinyLogic® |
| CorePLUS™ | Green FPS™ e-Series™ | QST™ | TINYOPTO™ |
| CorePOWER™ | Gmax™ | Quiet Series™ | TinyPower™ |
| CROSSVOLT™ | GTO™ | RapidConfigure™ | TinyPWM™ |
| CTL™ | IntelliMAX™ |  | TinyWire™ |
| Current Transfer Logic™ | ISOPLANAR™ | Saving our world, 1mW/W/kW at a time™ | TransiC™ |
| DEUXPEED® | Marking Small Speakers Sound Louder and Better™ | SignalWise™ | TriFault Detect™ |
| Dual Cool™ | MegaBuck™ | SmartMax™ | TRUECURRENT®* |
| EcoSPARK® | MICROCOUPLER™ | SMART START™ | µSerDes™ |
| EfficientMax™ | MicroFET™ | Solutions for Your Success™ |  |
| ESBC™ | MicroPak™ | SPM® | UHC® |
|  | MicroPak2™ | STEALTH™ | Ultra FRFET™ |
| Fairchild® | MillerDrive™ | SuperFET® | UniFET™ |
| Fairchild Semiconductor® | MotionMax™ | SuperSOT™-3 | VCX™ |
| FACT Quiet Series™ | MotionGrid® | SuperSOT™-6 | VisualMax™ |
| FACT® | MTI® | SuperSOT™-8 | VoltagePlus™ |
| FAST® | MTx® | SupreMOS® | XS™ |
| FastvCore™ | MVN® | SyncFET™ | Xsens™ |
| FETBench™ | mWSaver® | Sync-Lock™ | 仙童™ |
| FPS™ | OptoHiT™ | | |

*Trademarks of System General Corporation, used under license by Fairchild Semiconductor.

DISCLAIMER

FAIRCHILD SEMICONDUCTOR RESERVES THE RIGHT TO MAKE CHANGES WITHOUT FURTHER NOTICE TO ANY PRODUCTS HEREIN TO IMPROVE RELIABILITY, FUNCTION, OR DESIGN. TO OBTAIN THE LATEST, MOST UP-TO-DATE DATASHEET AND PRODUCT INFORMATION, VISIT OUR WEBSITE AT [HTTP://WWW.FAIRCHILDSEMI.COM](http://www.fairchildsemi.com). FAIRCHILD DOES NOT ASSUME ANY LIABILITY ARISING OUT OF THE APPLICATION OR USE OF ANY PRODUCT OR CIRCUIT DESCRIBED HEREIN; NEITHER DOES IT CONVEY ANY LICENSE UNDER ITS PATENT RIGHTS, NOR THE RIGHTS OF OTHERS. THESE SPECIFICATIONS DO NOT EXPAND THE TERMS OF FAIRCHILD'S WORLDWIDE TERMS AND CONDITIONS, SPECIFICALLY THE WARRANTY THEREIN, WHICH COVERS THESE PRODUCTS.

LIFE SUPPORT POLICY

FAIRCHILD'S PRODUCTS ARE NOT AUTHORIZED FOR USE AS CRITICAL COMPONENTS IN LIFE SUPPORT DEVICES OR SYSTEMS WITHOUT THE EXPRESS WRITTEN APPROVAL OF FAIRCHILD SEMICONDUCTOR CORPORATION.

As used here in:

- Life support devices or systems are devices or systems which, (a) are intended for surgical implant into the body or (b) support or sustain life, and (c) whose failure to perform when properly used in accordance with instructions for use provided in the labeling, can be reasonably expected to result in a significant injury of the user.
- A critical component in any component of a life support, device, or system whose failure to perform can be reasonably expected to cause the failure of the life support device or system, or to affect its safety or effectiveness.

ANTI-COUNTERFEITING POLICY

Fairchild Semiconductor Corporation's Anti-Counterfeiting Policy. Fairchild's Anti-Counterfeiting Policy is also stated on our external website, www.fairchildsemi.com, under Sales Support.

Counterfeiting of semiconductor parts is a growing problem in the industry. All manufactures of semiconductor products are experiencing counterfeiting of their parts. Customers who inadvertently purchase counterfeit parts experience many problems such as loss of brand reputation, substandard performance, failed application, and increased cost of production and manufacturing delays. Fairchild is taking strong measures to protect ourselves and our customers from the proliferation of counterfeit parts. Fairchild strongly encourages customers to purchase Fairchild parts either directly from Fairchild or from Authorized Fairchild Distributors who are listed by country on our web page cited above. Products customers buy either from Fairchild directly or from Authorized Fairchild Distributors are genuine parts, have full traceability, meet Fairchild's quality standards for handling and storage and provide access to Fairchild's full range of up-to-date technical and product information. Fairchild and our Authorized Distributors will stand behind all warranties and will appropriately address and warranty issues that may arise. Fairchild will not provide any warranty coverage or other assistance for parts bought from Unauthorized Sources. Fairchild is committed to combat this global problem and encourage our customers to do their part in stopping this practice by buying direct or from authorized distributors.

PRODUCT STATUS DEFINITIONS

Definition of Terms

Datasheet Identification	Product Status	Definition
Advance Information	Formative / In Design	Datasheet contains the design specifications for product development. Specifications may change in any manner without notice.
Preliminary	First Production	Datasheet contains preliminary data; supplementary data will be published at a later date. Fairchild Semiconductor reserves the right to make changes at any time without notice to improve design.
No Identification Needed	Full Production	Datasheet contains final specifications. Fairchild Semiconductor reserves the right to make changes at any time without notice to improve the design.
Obsolete	Not In Production	Datasheet contains specifications on a product that is discontinued by Fairchild Semiconductor. The datasheet is for reference information only.

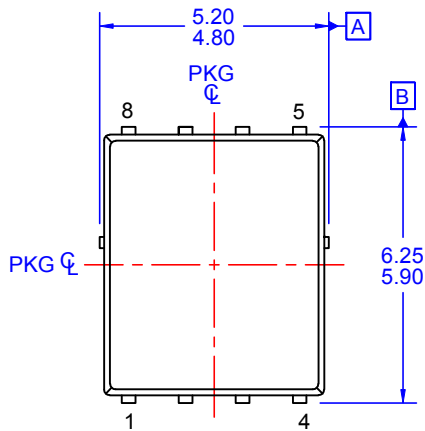

TOP VIEW

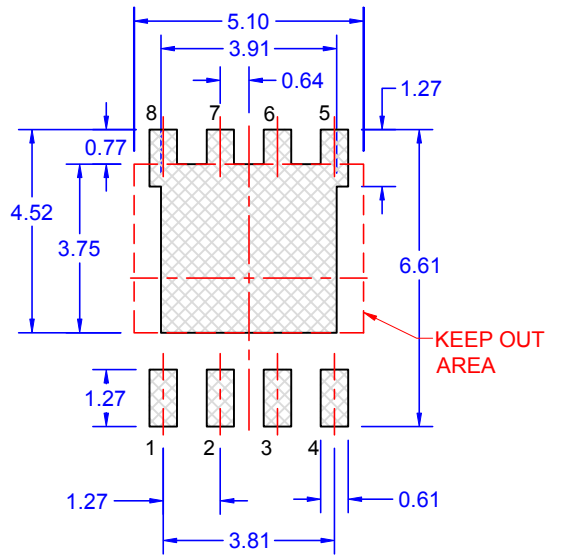
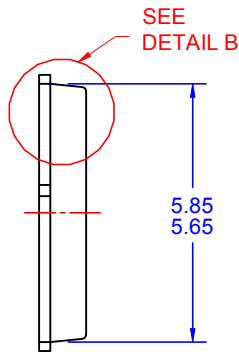

LAND PATTERN RECOMMENDATION

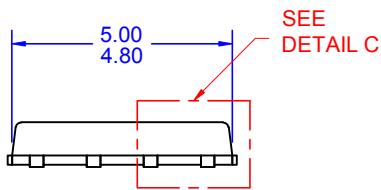

SIDE VIEW

OPTIONAL DRAFT ANGLE MAY APPEAR ON FOUR SIDES OF THE PACKAGE

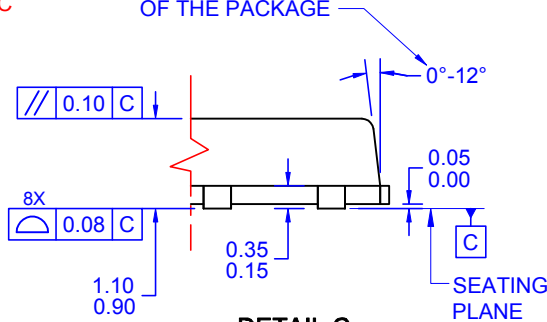

DETAIL C

SCALE: 2:1

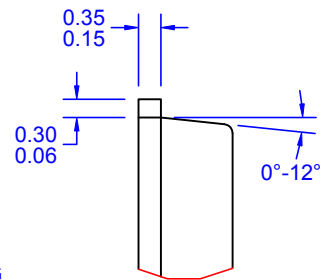

DETAIL B

SCALE: 2:1

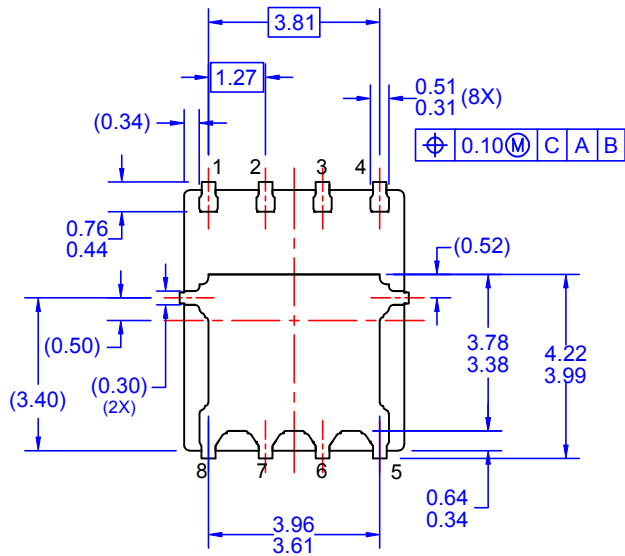

BOTTOM VIEW

NOTES: UNLESS OTHERWISE SPECIFIED

- A. PACKAGE STANDARD REFERENCE: JEDEC MO-240, ISSUE A, VAR. AA, DATED OCTOBER 2002.
- B. DIMENSIONS DO NOT INCLUDE BURRS OR MOLD FLASH. MOLD FLASH OR BURRS DOES NOT EXCEED 0.10MM.
- C. ALL DIMENSIONS ARE IN MILLIMETERS.
- D. DIMENSIONING AND TOLERANCING PER ASME Y14.5M-1994.
- E. IT IS RECOMMENDED TO HAVE NO TRACES OR VIAS WITHIN THE KEEP OUT AREA.
- F. DRAWING FILE NAME: PQFN08AREV8





TRADEMARKS

The following includes registered and unregistered trademarks and service marks, owned by Fairchild Semiconductor and/or its global subsidiaries, and is not intended to be an exhaustive list of all such trademarks.

AccuPower™	F-PFS™	OPTOPLANAR®	
AttitudeEngine™	FRFET®		TinyBoost®
Awinda®	Global Power Resource™	PowerTrench®	TinyBuck®
AX-CAP®*	GreenBridge™	PowerXS™	TinyCalc™
BitSiC™	Green FPS™	Programmable Active Droop™	TinyLogic®
Build it Now™	Green FPS™ e-Series™	QFET®	TINYOPTO™
CorePLUS™	Gmax™	QS™	TinyPower™
CorePOWER™	GTO™	Quiet Series™	TinyPWM™
CROSSVOLT™	IntelliMAX™	RapidConfigure™	TinyWire™
CTL™	ISOPLANAR™		TranSiC™
Current Transfer Logic™	Making Small Speakers Sound Louder and Better™	Saving our world, 1mW/W/kW at a time™	TriFault Detect™
DEUXPEED®	MegaBuck™	SignalWise™	TRUECURRENT®*
Dual Cool™	MICROCOUPLER™	SmartMax™	μSerDes™
EcoSPARK®	MicroFET™	SMART START™	
EfficientMax™	MicroPak™	Solutions for Your Success™	UHC®
ESBC™	MicroPak2™	SPM®	Ultra FRFET™
	MillerDrive™	STEALTH™	UniFET™
Fairchild®	MotionMax™	SuperFET®	VCX™
Fairchild Semiconductor®	MotionGrid®	SuperSOT™-3	VisualMax™
FACT Quiet Series™	MTI®	SuperSOT™-6	VoltagePlus™
FACT®	MTX®	SuperSOT™-8	XS™
FAST®	MVN®	SupreMOS®	Xsens™
FastvCore™	mWSaver®	SyncFET™	仙童™
FETBench™	OptoHiT™	Sync-Lock™	
FPS™	OPTOLOGIC®		

* Trademarks of System General Corporation, used under license by Fairchild Semiconductor.

DISCLAIMER

FAIRCHILD SEMICONDUCTOR RESERVES THE RIGHT TO MAKE CHANGES WITHOUT FURTHER NOTICE TO ANY PRODUCTS HEREIN TO IMPROVE RELIABILITY, FUNCTION, OR DESIGN. TO OBTAIN THE LATEST, MOST UP-TO-DATE DATASHEET AND PRODUCT INFORMATION, VISIT OUR WEBSITE AT [HTTP://WWW.FAIRCHILDSEMI.COM](http://www.fairchildsemi.com). FAIRCHILD DOES NOT ASSUME ANY LIABILITY ARISING OUT OF THE APPLICATION OR USE OF ANY PRODUCT OR CIRCUIT DESCRIBED HEREIN; NEITHER DOES IT CONVEY ANY LICENSE UNDER ITS PATENT RIGHTS, NOR THE RIGHTS OF OTHERS. THESE SPECIFICATIONS DO NOT EXPAND THE TERMS OF FAIRCHILD'S WORLDWIDE TERMS AND CONDITIONS, SPECIFICALLY THE WARRANTY THEREIN, WHICH COVERS THESE PRODUCTS.

LIFE SUPPORT POLICY

FAIRCHILD'S PRODUCTS ARE NOT AUTHORIZED FOR USE AS CRITICAL COMPONENTS IN LIFE SUPPORT DEVICES OR SYSTEMS WITHOUT THE EXPRESS WRITTEN APPROVAL OF FAIRCHILD SEMICONDUCTOR CORPORATION.

As used herein:

1. Life support devices or systems are devices or systems which, (a) are intended for surgical implant into the body or (b) support or sustain life, and (c) whose failure to perform when properly used in accordance with instructions for use provided in the labeling, can be reasonably expected to result in a significant injury of the user.
2. A critical component in any component of a life support, device, or system whose failure to perform can be reasonably expected to cause the failure of the life support device or system, or to affect its safety or effectiveness.

ANTI-COUNTERFEITING POLICY

Fairchild Semiconductor Corporation's Anti-Counterfeiting Policy. Fairchild's Anti-Counterfeiting Policy is also stated on our external website, www.fairchildsemi.com, under Sales Support.

Counterfeiting of semiconductor parts is a growing problem in the industry. All manufacturers of semiconductor products are experiencing counterfeiting of their parts. Customers who inadvertently purchase counterfeit parts experience many problems such as loss of brand reputation, substandard performance, failed applications, and increased cost of production and manufacturing delays. Fairchild is taking strong measures to protect ourselves and our customers from the proliferation of counterfeit parts. Fairchild strongly encourages customers to purchase Fairchild parts either directly from Fairchild or from Authorized Fairchild Distributors who are listed by country on our web page cited above. Products customers buy either from Fairchild directly or from Authorized Fairchild Distributors are genuine parts, have full traceability, meet Fairchild's quality standards for handling and storage and provide access to Fairchild's full range of up-to-date technical and product information. Fairchild and our Authorized Distributors will stand behind all warranties and will appropriately address any warranty issues that may arise. Fairchild will not provide any warranty coverage or other assistance for parts bought from Unauthorized Sources. Fairchild is committed to combat this global problem and encourage our customers to do their part in stopping this practice by buying direct or from authorized distributors.

PRODUCT STATUS DEFINITIONS

Definition of Terms

Datasheet Identification	Product Status	Definition
Advance Information	Formative / In Design	Datasheet contains the design specifications for product development. Specifications may change in any manner without notice.
Preliminary	First Production	Datasheet contains preliminary data; supplementary data will be published at a later date. Fairchild Semiconductor reserves the right to make changes at any time without notice to improve design.
No Identification Needed	Full Production	Datasheet contains final specifications. Fairchild Semiconductor reserves the right to make changes at any time without notice to improve the design.
Obsolete	Not In Production	Datasheet contains specifications on a product that is discontinued by Fairchild Semiconductor. The datasheet is for reference information only.

Rev. I73