

## Features

- 50 pcs.

## RS PRO Rack Mounting Hardware

RS Stock No.: 0749247



RS PRO is the own brand of RS. The RS PRO Seal of Approval is your assurance of professional quality, a guarantee that every part is rigorously tested, inspected, and audited against demanding standards. Making RS PRO the Smart Choice for our customers.

## Product Description

- It is used for two-point connected rack systems, server cabinets, network devices, industrial racks, and many other mounting applications.*

## General Specifications

Thread Size	M6
Material	Steel
Quantity	50pcs in a bag
Finish	Low Carbon Steel Cr+3 plated
Thread Direction	Right

## Mechanical Specifications

Overall Width	13.2mm
Cut-Out Dimensions	9.5x9.5mm

## Similar Products

Parameters	Description
RS Pro Code	0749247
Quantity	50pcs in a bag
Thread Size	M6
Overall Width	13x2mm X 13x5mm
Cut-Out Dimensions	9.5mm X 9.5mm(Square)
Material	Steel
Finish	Low Carbon Steel Cr+3 plated
Thread Direction	Right

Top View

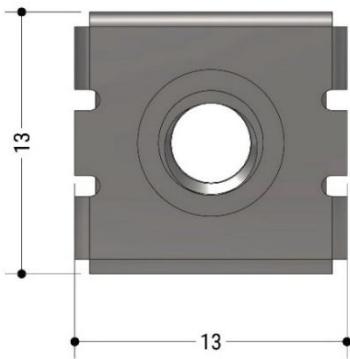

Isometric View

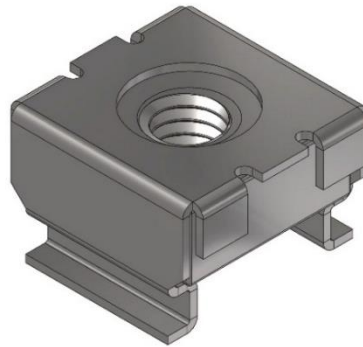

Bottom View



Side View

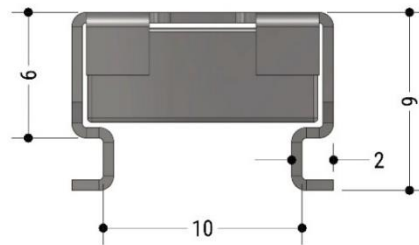

Top View



Side View

