

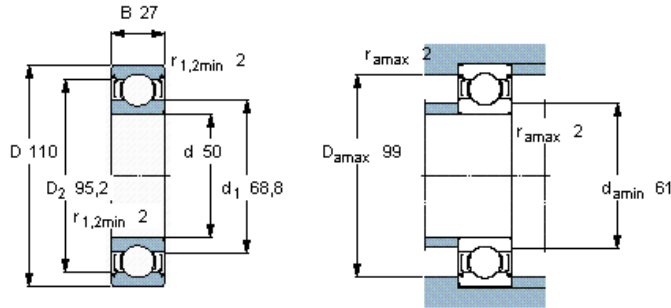

United... Products Bearings, units and... Ball bearings Deep groove ball bearings SKF Energy Efficient (E2) deep groove ball bearings
 Deep groove ball bearings, single row, SKF Energy Efficient (E2) bearings

Principal dimensions			Basic load ratings		Speed ratings	Limiting speed	Designation
d	D	B	dynamic C	static C ₀	Reference speed r/min		
m.m			kN				-
50	110	27	62,4	38	15000	7800	E2.6310-2Z/C3



Calculation factors

k_r 0,03
 f_0 13