

NT 041511/04

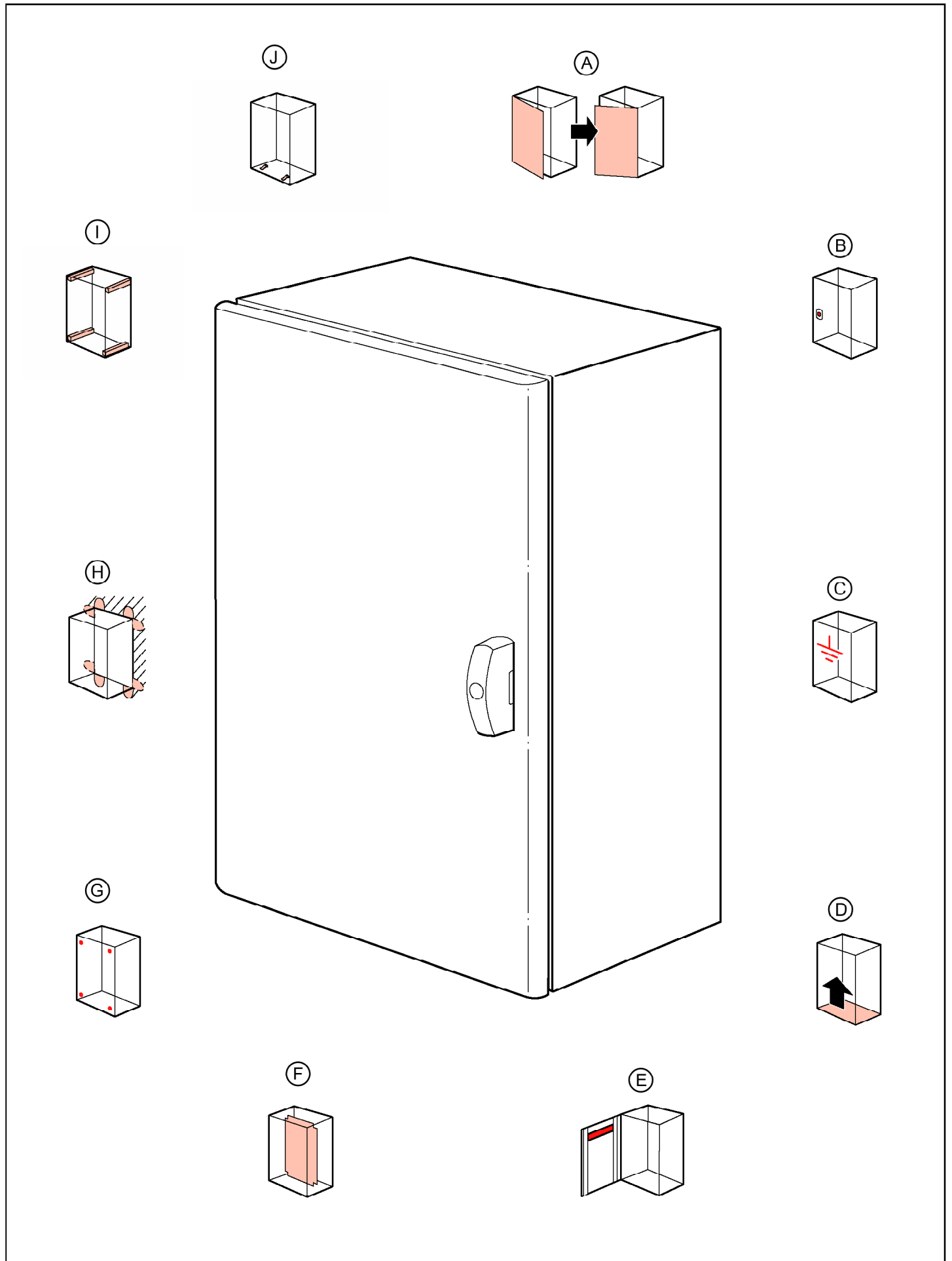

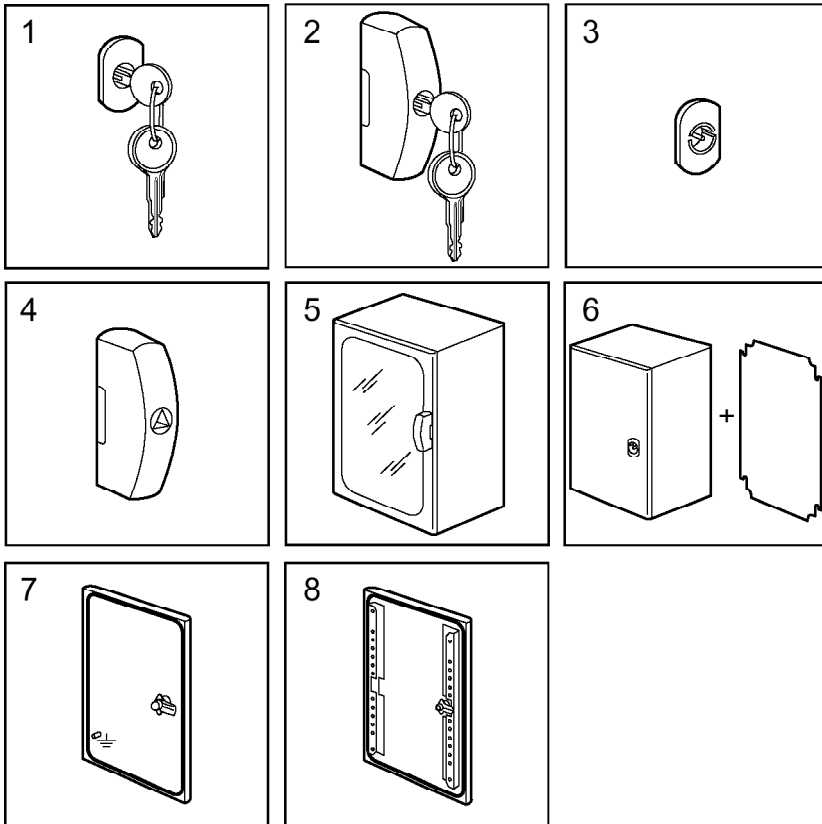

36743/44/45

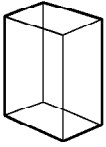
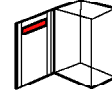
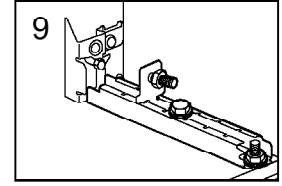

36735 + 37407

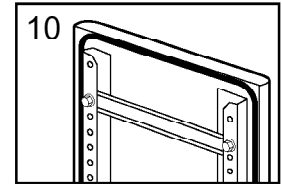

36736

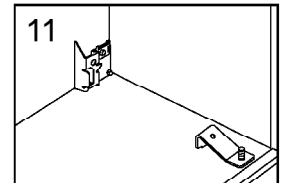

	Ral 7032	AFNOR 2525	1	2	3	4	5	6	7	8	9	10	11
35500	●		●					●	●				○
35501/30	●		●						●				○
35502/31	●			●					●				○
35503/04/06/07/08/32	●			●						●		○	○
35510/12/14/15/17/18/20/22/23/24/26/27	●			●						●		○	○
355 28/29/33/34/36/91/92/93/94/95/96/97/98	●			●						●		○	○
35492/93/94	●			●			●		●				○
35495/96/97	●			●			●		●			○	○
35560		●			●		●	●	●				○
35562		●			●				●				○
35567/68		●			●				●	●			○
35570/82/83/87		●			●					●			○
35418/30	●				●			●					○
35419/20/29/31/32/33/34/35/49/51	●				●			●		●			○
35400/01/02/03/04/05/06/07/08/09/21/22/23	●				●			●		●			○
35436/37/38/39/40/41/42/43/44/45/46/47/48	●				●			●		●			○
35470/71/72/73/74/75	●				●		●		●				○
35476/77/78/79/80/81/82/83/84	●				●		●		●				○

