

# PRODUCT DATASHEET

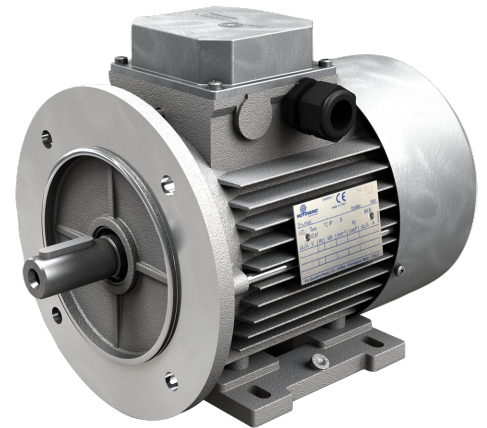

## ELECTRIC MOTOR

**DATE** 27.05.2020

**CUSTOMER** RS COMPONENTS

**APPLICATION** TP112MS4 3 230/400-50 B14  
MV

**NOTE** 4167458

CHARACTERISTIC	VALUE
<b>Supplier</b>	Motovario
<b>Regulations</b>	CE
<b>Motor</b>	Three-Phase
<b>Size</b>	112
<b>Series</b>	Premium Efficiency
<b>Poles</b>	4
<b>Electrical Execution</b>	Std (Voltage Tolerance +/- 10%)
<b>Service</b>	S1
<b>Voltage</b>	230/400-265/460 V
<b>Frequency</b>	50-60 Hz
<b>Power</b>	3 kW
<b>Cooling</b>	Self-Ventilated
<b>Mounting Arrangements</b>	B14
<b>Flange Dim.</b>	Ø160
<b>Shaft Dim. (DE)</b>	Ø28x60
<b>Rear Shaft End (NDE)</b>	No
<b>Insulation Rating</b>	F
<b>Protection Rating</b>	IP55
<b>Thermal Protectors</b>	No
<b>Ambient Conditions</b>	Standard
<b>Heaters</b>	No
<b>Condensation Drainage</b>	No
<b>Devices</b>	No
<b>Accessories</b>	None
<b>Terminal Box Cover</b>	Aluminium
<b>Fan</b>	Plastic
<b>Fan Cover</b>	Standard
<b>MO-Notes</b>	No

Values expressed in [mm]

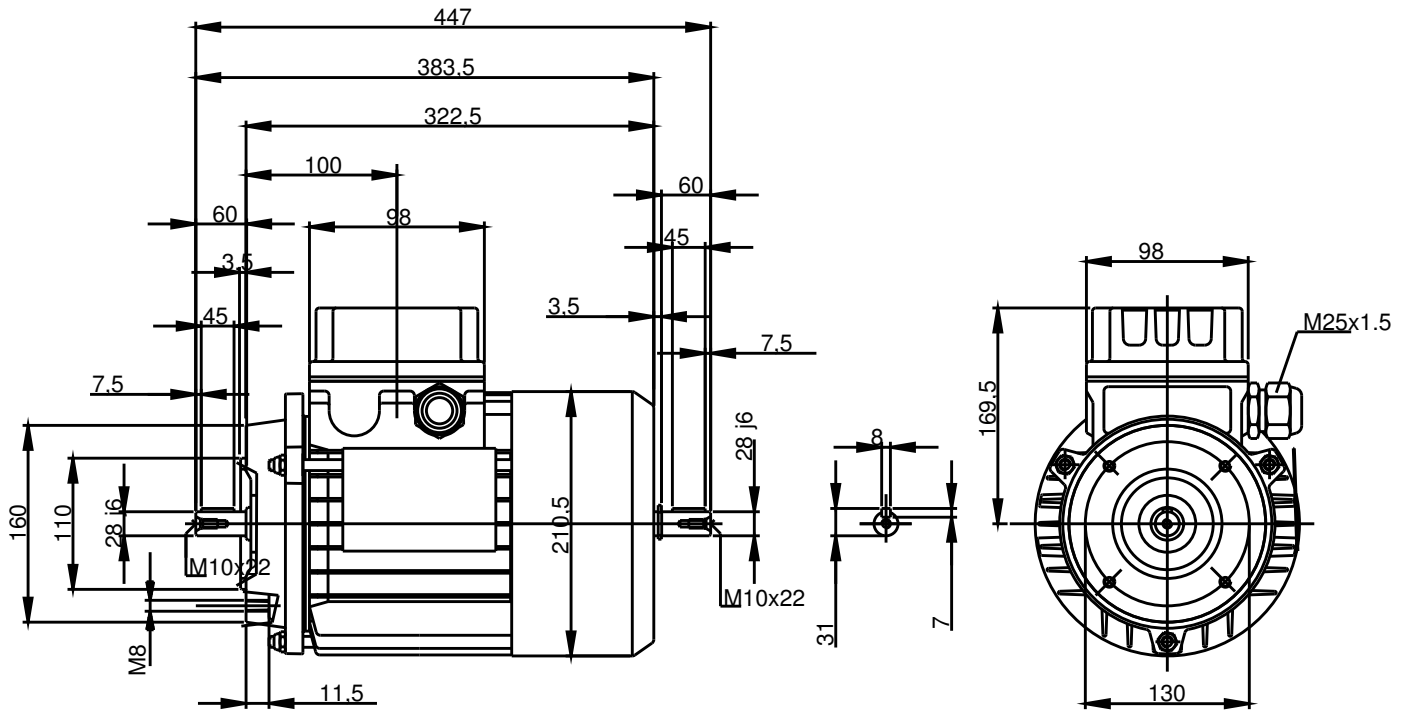

# PERFORMANCES

P <sub>n</sub> [kW]	Size	n <sub>n</sub> [rpm]	I <sub>n</sub> [A]	M <sub>n</sub> [Nm]	IE3	η <sub>n</sub> % (4/4) limit	η <sub>n</sub> % (4/4)	η <sub>n</sub> % (3/4)	η <sub>n</sub> % (2/4)	cosφ <sub>n</sub>	M <sub>s</sub> M <sub>n</sub>	I <sub>s</sub> I <sub>n</sub>	M <sub>max</sub> M <sub>n</sub>	10 <sup>-4</sup> × Kg m <sup>2</sup>		Kg		Z <sub>0</sub> [10 <sup>3</sup> × 1/h]	M <sub>B</sub> [Nm]
														T T	T TB	T T	T TB		
3,00	112MS4	1450	6,16	19,76	IE3	87,7	87,8	88,0	86,7	0,80	3,5	7,9	3,5	137,0	146,0	33,0	43,0	2,5	40,0





# MOUNTING POSITIONS

**Mounting position:** specific construction in relation to the mounting equipment, type of bearings and shaft end.

**Installation type:** positioning of the motor in relation to the axis line (horizontal or vertical) and mounting equipment.

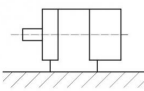
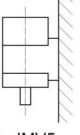
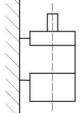
The table lists the most common installation methods in relation to the mounting position.

With reference to standard IEC 34-7, the electric motor's nameplate must be marked with the mounting position (IMB3, IMB5, IMB14, IMB34, IMB35) independently of the installation type.

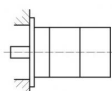
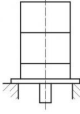
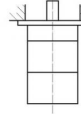
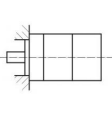
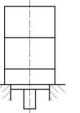
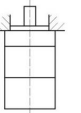
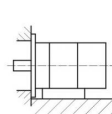
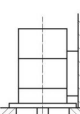
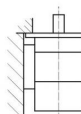
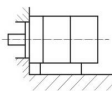
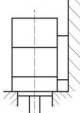
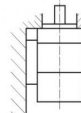
<b>IMB3</b>	     
<b>IMB5</b>	  
<b>IMB14</b>	  
<b>IMB35</b>	  
<b>IMB34</b>	  

Mounting position:

- IMB3 with feet
- IMB5 with drive side flange, through holes
- IMB14 with drive side flange, threaded holes
- IMB35 with feet and drive side flange, through holes
- IMB34 with feet and drive side flange, threaded holes

Besides being available in the above-indicated standardised mounting positions, motors are available also in compact versions; this applies to both aluminium CHA and CBA gear reducers (B10 mounting position) and to cast iron CH, CB and CS gear reducers (B11 mounting position). These mounting positions require special flanges integral with the gear reducer and cable output shaft where pinion is fitted before the reduction stage. The resulting gearmotor has reduced axial size. For further details, including dimensional drawings, refer to the specific catalogues of the gear reducers.