

TX700 HMI/PLC Series

7" Sunlight Readable Display — CODESYS V3 PLC with TARGET and WEB VISU

High-Quality Metal Housing and Glass Front with a Capacitive Touch

TX707HB-P3CV01



- 7" TFT wide screen color display
- LED backlight
- 800 x 480 pixel resolution
- 16 M colors
- Capacitive touchscreen with glass front
- Higher level of brightness for improved readability in sunlight
- Greater screen quality thanks to liquid bonding (LOCA), which improves contrast and brightness by reducing reflection and refraction
- Extended temperature range
- Increased robustness against mechanical influences
- All-metal housing, coated to protect the PCB
- 1 RJ45 Ethernet port with 10/100/1000 Mbit
- 2 RJ45 Ethernet ports with 10/100 Mbit
- 1 serial interface (RS232, RS485, RS422)
- 2 USB host ports
- 1 SD card slot

Type designation	TX707HB-P3CV01
Ident no.	100007473
Display / Touch	
Display	TFT colour
Touchscreen	Capacitive, Glass front
Active screen area	7"
Resolution (pixels)	800 × 480 WVGA
Format	16:9
Brightness	600 Cd/m ² typ.
dimnable	yes, to 0 %
Controller	
Processor	ARM Cortex A9, Dual-core 800 MHz
Memory	4 GB Flash
RAM memory	1024 MB
Add-on memory	1x SD card slot, 2 USB host ports
Real time clock	Yes (battery-buffered)
PLC data	
Programming	CODESYS V3
Released for CODESYS version	V 3.5.12.10
Programming languages	IEC 61131-3 (IL, LD, FBD, SFC, ST)
Programming interface	Ethernet
Program memory	20000 kByte
Non-volatile memory	63 kByte
Interfaces	
Onboard	3 × RJ45 Ethernet, 1 × RS232/485/422, 2 × USB host, 1 × power supply, 2 × expansion slot
Onboard for selection	CANopen Master (via extension module)
Ethernet	ETH0 - 10/100/1000 Mbit ETH1 - 10/100 Mbit ETH2 - 10/100 Mbit
Protocols	PROFINET (Controller/Master) EtherNet/IP (Scanner/Master) Modbus TCP (Master/Slave)
Fieldbus	Modbus RTU (Master/Slave) CANopen (Master)
USB	2 × host ports
Serial	RS232 / RS485 / RS422
Expansion slot	Two slots for up to four plug-in modules
Power supply	
Rated value	24 VDC, max. 0.7 A
Admissible voltage range	10...32 VDC

TX700 HMI/PLC Series**7" Sunlight Readable Display — CODESYS V3 PLC with TARGET and WEB VISU****High-Quality Metal Housing and Glass Front with a Capacitive Touch****TX707HB-P3CV01****General data**





Operating ambient conditions	-20...60 °C, 5...85 % relative humidity, non-condensing
Storage ambient conditions	-20...70 °C, 5...85 % rel. humidity, non-condensing
Approvals	CE
Protection class	IP66 front, IP20 rear

Dimensions

Front (W x H x D)	187 x 147 x 47 mm
Cut-out (W x H)	176 x 136 mm
Mounting depth	47+8 mm
Weight	approx. 1.5 kg

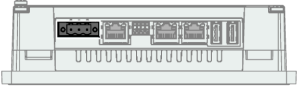
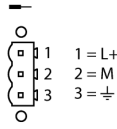
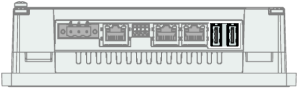
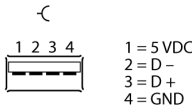
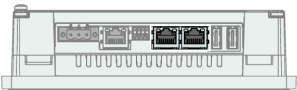
TX700 HMI/PLC Series
7" Sunlight Readable Display — CODESYS V3 PLC with TARGET and WEB VISU
High-Quality Metal Housing and Glass Front with a Capacitive Touch
TX707HB-P3CV01

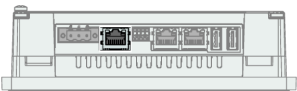
Connection and pin assignment

	<p>Power Supply The power supply connector is delivered with each device.</p>	<p>Pin Assignment</p> 
	<p>USB Interface</p>	<p>Pin Assignment</p> 
	<p>Ethernet Ethernet ports ETH1 and ETH2 (10/100 Mbit) The Ethernet ports are independent, but can be bridged with ETH0. Ethernet cables (examples): RJ45 male connector – RJ45 male connector: RJ45S-RJ45S-4414-2M (order number: 6441423) RJ45 male connector – M12 male connector, 4-pin, D-coded: RSSD-RJ45S-4414-2M (order number: 6441413) RJ45 male connector – M8 male connector, 4-pin: PSGS4M-RJ45S-4414-2M (order number: 6933005) RJ45 male connector — M12 female receptacle, 4-pin, D-coded: RJ45-FKSDD-4414-2M (order number: 6935282)</p>	<p>Pin Assignment</p> 
	<p>Ethernet Ethernet port ETH0 (10/100/1000 Mbit)</p>	<p>Pin Assignment</p> 

TX700 HMI/PLC Series

7" Sunlight Readable Display — CODESYS V3 PLC with TARGET and WEB VISU

High-Quality Metal Housing and Glass Front with a Capacitive Touch

TX707HB-P3CV01

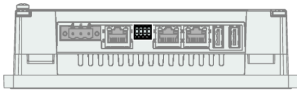

Serial Interface

The serial interface can be operated either as RS232, RS485 or RS422. The adjacent wiring diagrams show the respective pin assignments.

PLEASE NOTE: In RS485 mode, pins 1 and 2 as well as 3 and 4 must be externally connected!

Pin Assignment in RS232 Operating Mode

- 1 = RX
- 2 = TX
- 3 = CTS
- 4 = RTS
- 5 = +5 VDC output
- 6 = GND
- 7 = n.c.
- 8 = shield



Pin Assignment in RS485 Operating Mode

- 1 = B- (RX-)
- 2 = A- (TX-)
- 3 = B+ (RX+)
- 4 = A+ (TX+)
- 5 = +5 VDC output
- 6 = GND
- 7 = n.c.
- 8 = shield



Pin Assignment in RS422 Operating Mode

- 1 = RX-
- 2 = TX-
- 3 = RX+
- 4 = TX+
- 5 = +5 VDC output
- 6 = GND
- 7 = n.c.
- 8 = shield

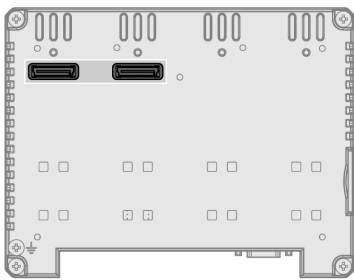

Ports for Plug-in Modules



SD Card Slot

SD card (example): SD CARD 2 GB (order number: 6828025)

TX700 HMI/PLC Series

7" Sunlight Readable Display — CODESYS V3 PLC with TARGET and WEB VISU

High-Quality Metal Housing and Glass Front with a Capacitive Touch

TX707HB-P3CV01

Accessories

Type code	Ident no.	Description	Dimension drawing
TX700-MOUNT-07	100003188	TX700 mounting bracket and power connectors for 5–7" devices	

Function accessories

Type code	Ident no.	Description	Dimension drawing
TX-IO-XX03	6828201	Plug-in I/O module — 20 DI, 12 DO, 4 AI (U/I/RTD/TC), 4 AO (U/I)	
TX-IO-DX06	6828203	Plug-in I/O module — 8 DI, 6 DO, 1 relay output (NO)	
TX-UMTS	100009535	Plug-in radio modem with 2G/3G support	
TX-DP-S	100010167	Plug-in PROFIBUS DP slave interface, 9-pin SUB-D female connector	

TX700 HMI/PLC Series

7" Sunlight Readable Display — CODESYS V3 PLC with TARGET and WEB VISU

High-Quality Metal Housing and Glass Front with a Capacitive Touch

TX707HB-P3CV01

Function accessories

Type code	Ident no.	Description	Dimension drawing
TX-CAN	6828210	Plug-in CANopen interface, 9-pin SUB-D male connector	
TX-RS485	100002598	Plug-in interface for RS485/RS422, 9-pin SUB-D female connector	
TX-RS232	100002599	Plug-in interface for RS232, 9-pin SUB-D female connector	
TX-PSC	100002938	Power Supply Male Connector for TX HMI Devices	