

Overview

KEMET’s QFC pyroelectric flame sensors provide accurate discrimination of flame sources in triple IR flame detection systems, through its excellent signal to noise characteristic at the signature 8 – 10 Hz flicker range of a flame. The sensor element is built into a low noise circuit that has an internal CMOS op amp with a 10 GΩ feedback resistor outputting a voltage signal centred around half the supply rail. Exceptional high responsivity, a wide field of view and rapid recovery from thermal and electrical shocks makes it the ideal solution for demanding flame detecting applications.

Applications

- Industrial
- Oil and gas
- Infrastructure protection
- Forest protection

Benefits

- Exceptionally high responsivity
- Wide field of view, typically 100° (subject to filter band pass specification)
- Rapid recovery from thermal and electrical shock (< 1 second downtime)
- T039 package
- Analog output
- Integrated op amp

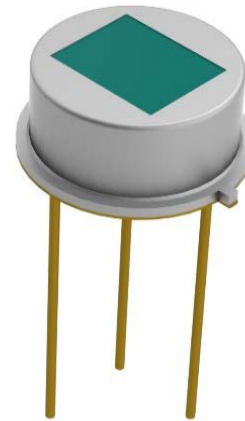

Ordering Information

USE	QFC	S	A	3381	0	0
Product Family	Series	Sensor Type	Mounting Type	Specification	Packaging	Version
Sensors	QFC = T039 Flame Sensors	S = Single K = Evaluation Kit	A = Sensor Only 4 = Evaluation Kit Type 4	0000 = Fixed 3381 = 3.38 μm bandpass 3911 = 3.91 μm bandpass 4351 = 4.35 μm bandpass 4481 = 4.48 μm bandpass 4551 = 4.55 μm bandpass 5001 = 5.00 μm cut on 5501 = 5.50 μm cut on	0 = Bulk	0

Environmental Compliance

All KEMET Flame Sensors are RoHS and REACH Compliant.



Article 33(1) of the REACH Regulation states that manufacturers and importers of articles (products) are required to notify their customers of the presence of any Substances of Very High Concern (SVHC) in their products exceeding 0.1% by weight and provide instructions on safe use of the product.

KEMET Corporation reports regarding the Article 33(1) of REACH Regulation as follows:

1. Applicable Product: Flame Sensors (QFC & QFS series)

2. Report for the content of REACH SVHC list:

The product(s) above contains a substance by more than 0.1wt% per product weight that was published in the 8th update of the REACH SVHC substances (December 19, 2012).

3. Regarding the safety of the flame sensors (Piezoceramic products):

The Piezoceramic that is used in this product becomes ceramic by sintering powder containing PZT as the main ingredient. It is chemically stable, with minimum risks toward the human body or environment within the intended use of the product. Please note that risks could occur in the case of inhalation or accidental oral uptake of powder ceramics.

4. Technical product information on the flame sensors (Piezoceramic products):

The manufacturing technique of the "piezoceramic products" whose main ingredient is Lead Titanium Zirconium Oxide (PZT) has been established, and there is no alternative material that can exhibit superior performance than PZT at this moment. Please note that the piezoceramic is listed as an exempt on RoHS (2011/65/EU) AnnexIII (7c.1).

5. The responsibility of piezoceramic manufacturers:

Piezoceramic manufacturers report information regarding PZT containment in their products to the customers to obey the article 33 of the REACH regulation

Dimensions – Millimeters

Cross Section View

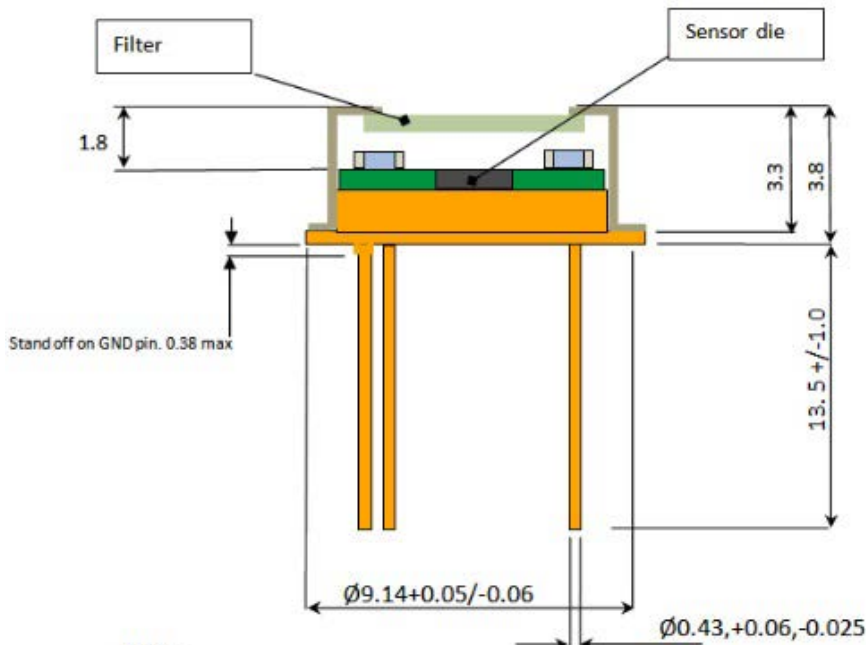

Note: -

Dimensions in mm (Not to scale)

Dimensions are typical, unless tol stated.

Top View

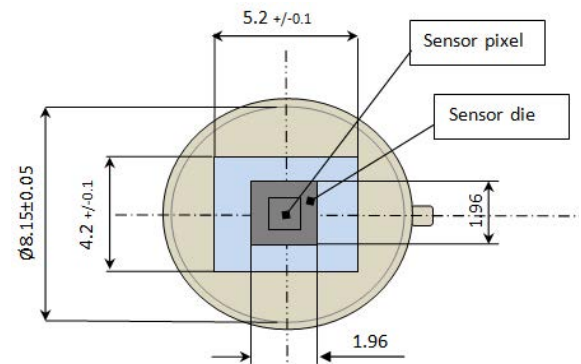

Bottom View

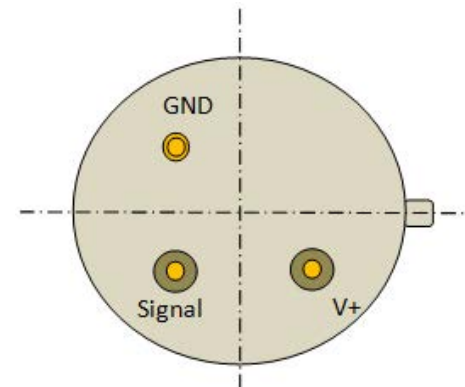

Field of View

For V across horizontal window aperture

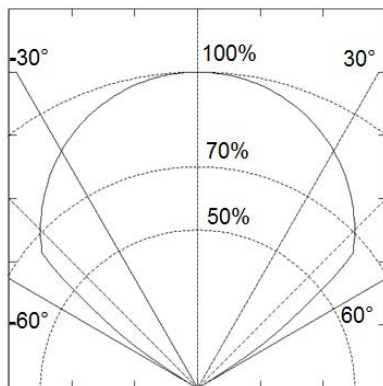

For V across vertical window aperture

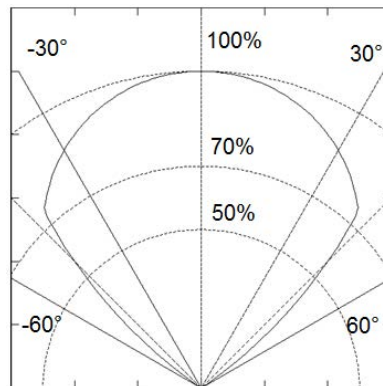

For V across diagonal window aperture

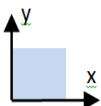
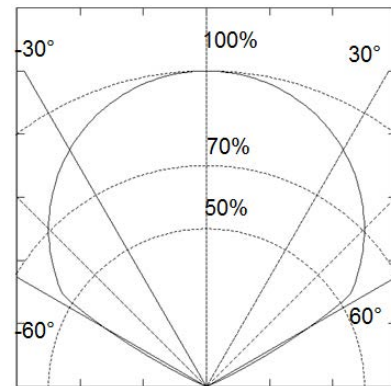

Note: Normalised polar plots show max FoV achievable along x, y axis and diagonal without any filter applied.

Part Number Specifications

Sensor Characteristics

Filter Aperture (mm)	Element Size (µm)	Package	Responsivity ¹ (V/W)	D*1 (cm√Hz/W)	Noise ¹ (µV√Hz)	Field of View ²
5.2 x 4.2	1,000 x 1,000	T039	150,000	3.5 x 108	Mean 70	Typical 100°

¹ 10 Hz, 500 K, room temperature, without window and optics.

² With reference to filter used in USEQFCSA435100.

Electrical Characteristics

Maximum Voltage ¹ (V)	Minimum Voltage (V)	Microphonics (µV/√Hz) at 10 Hz	Time Constant (ms)	Operating Temperature Range (°C)	Storage Temperature Range (°C)
8	2.7	S vib~2	~12	-40 to +85	-40 to +110

¹ Absolute maximum operating voltage.

Output voltage normalised around mid-rail.

Op-Amp with 10 GΩ feedback resistor.

Part Number (Sensor)

Part Number	Filter Name	Cut On Wavelength (µm) Typical	Cut Off Wavelength (µm) Typical	Weight (gr)
USEQFCSA338100	3.38 µm bandpass	3.295	3.475	0.95
USEQFCSA391100	3.91 µm bandpass	3.865	3.955	0.95
USEQFCSA435100	4.35 µm bandpass	4.050	4.650	0.95
USEQFCSA448100	4.48 µm bandpass	4.170	4.790	0.95
USEQFCSA455100	4.55 µm bandpass	4.340	4.760	0.95
USEQFCSA500100	5.00 µm cut on	5.000	-	0.95
USEQFCSA550100	5.50 µm cut on	5.500	-	0.95

An additional window is required to provide high wavelength blocking (above 8.0 µm) and thermal shielding.

Part Number (Evaluation Kit)

Part Number	Comment	Weight (gr)
USEQFCK4000000	Includes 3 sensors: USEQFCSA391100, USEQFCSA435100, USEQFCSA500100	650

Part Schematic

Internal Schematics

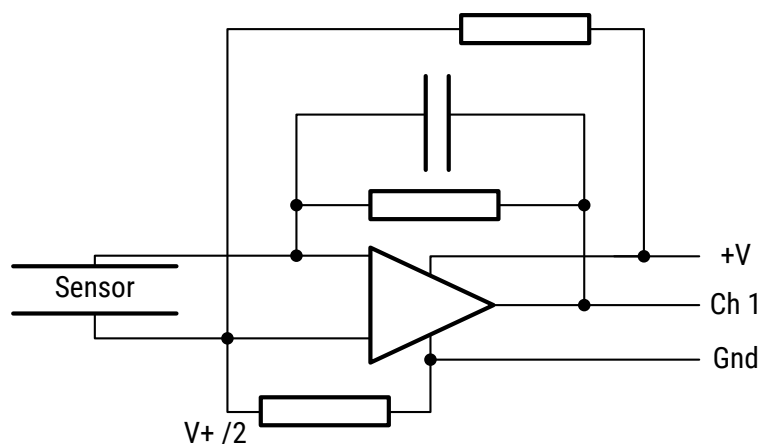

Packaging

Series	Packaging Type
QFC	Bulk

Handling Precautions

Pyroelectric Infrared Sensors should be kept away from indirect and direct sunlight, the headlights of cars, wind, and exposure to strong vibration and strong shock.

Do not use in water, alcohol ETA, corrosive gas or under sea breeze.

Do not be expose to corrosive substances.

Do not drop or apply any mechanical stress.

The performance of this device can be affected by ESD. Precautions should be used when handling and installing the sensor. Precision devices such as this sensor can be damaged or caused not to meet published specification due to ESD. Please note that there is limited ESD protection built-in as the device is optimised for low power consumption and low noise operation. Human Body Model (HBM), per JS-001: 2,000 V.

Pyroelectric Infrared Sensors should be stored in normal working environments.

Solderability will be degraded by exposure to high temperatures, high humidity, corrosive atmospheres, and long-term storage.

KEMET recommends that ambient storage conditions are < 30°C and < 60% relative humidity and that maximum storage temperature does not exceed 110°C. Atmospheres should be free of chlorine and sulfur-bearing compounds.

Temperature fluctuations should be minimized to avoid condensation on the parts.

For optimized solderability sensors stock should be used promptly, preferably within 24 months of receipt.

KEMET Electronics Corporation Sales Offices

For a complete list of our global sales offices, please visit www.kemet.com/sales.

Disclaimer

All product specifications, statements, information and data (collectively, the "Information") in this datasheet are subject to change. The customer is responsible for checking and verifying the extent to which the Information contained in this publication is applicable to an order at the time the order is placed. All Information given herein is believed to be accurate and reliable, but it is presented without guarantee, warranty, or responsibility of any kind, expressed or implied.

Statements of suitability for certain applications are based on KEMET Electronics Corporation's ("KEMET") knowledge of typical operating conditions for such applications, but are not intended to constitute – and KEMET specifically disclaims – any warranty concerning suitability for a specific customer application or use. The Information is intended for use only by customers who have the requisite experience and capability to determine the correct products for their application. Any technical advice inferred from this Information or otherwise provided by KEMET with reference to the use of KEMET's products is given gratis, and KEMET assumes no obligation or liability for the advice given or results obtained.

Although KEMET designs and manufactures its products to the most stringent quality and safety standards, given the current state of the art, isolated component failures may still occur. Accordingly, customer applications which require a high degree of reliability or safety should employ suitable designs or other safeguards (such as installation of protective circuitry or redundancies) in order to ensure that the failure of an electrical component does not result in a risk of personal injury or property damage.

Although all product-related warnings, cautions and notes must be observed, the customer should not assume that all safety measures are indicated or that other measures may not be required.

When providing KEMET products and technologies contained herein to other countries, the customer must abide by the procedures and provisions stipulated in all applicable export laws and regulations, including without limitation the International Traffic in Arms Regulations (ITAR), the US Export Administration Regulations (EAR) and the Japan Foreign Exchange and Foreign Trade Act.

KEMET is a registered trademark of KEMET Electronics Corporation.