

Mounting bracket
with strain
relief option

e-chain® zip-open
along outer radius

Two-piece
link design

Small pitch
for low-noise,
smooth running

Large pin for
high stability

Can be separated
and joined at each link

Double stop dog
for long un-
supported travels

Interior separation
possible

For high
accelerations

⊕ Fast opening, high stability

When to use Series 15:

- If a very small e-chain® with an inner height of 17 mm and smallest bending radii are required
- For inner widths up to 100 mm
- For unsupported lengths up to 1,20 m and fill weights up to 1,5 kg/m
- If high stability and excellent service life is required
- Small pitch for smooth running
- If fast, zipper-like accessibility to cables is required



When to use a different igus® Series:

- If a fully enclosed e-tube with zipper opening mechanism is required
- ▶ **Series R15 zipper e-tube, page 4.46**
- If snap-open accessibility along the inner radius is required
- ▶ **Series B15i E2 mini, page 5.112**
- If snap-open links are not necessary
- ▶ **Series 10 E2 mini, page 5.80**
- If torsion occurs
- ▶ **Series E14 easy chain®, page 3.32**



Available from stock. Delivery in 24h or today!*

*Delivery time means time until shipping of goods



3D-CAD files, configurators, PDF ▶ www.igus.de/en/15

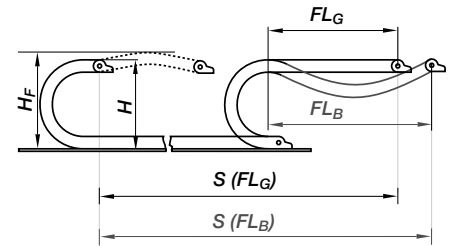
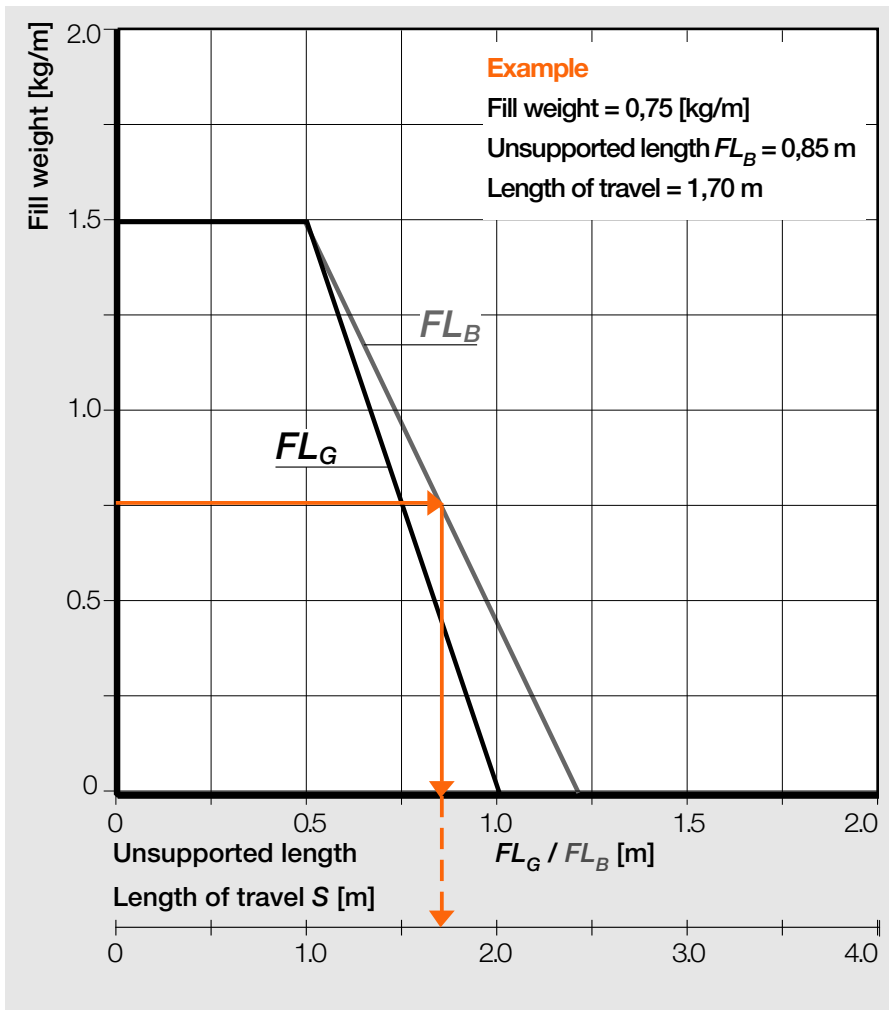

Standard **Unsupported applications**

Unsupported e-chains® feature positive camber over short travels. This must be accounted for when specifying the clearance height H_F . Please consult igus® if space is particularly restricted. More information ► **Design, page 1.8**

Technical Data

Speed, material, temperature and flammability class ► **page 4.6**

- Pitch** = 30,5 mm/link
- Links/m** = 33 (1006,5 mm)
- Chain length** = $S/2 + K$

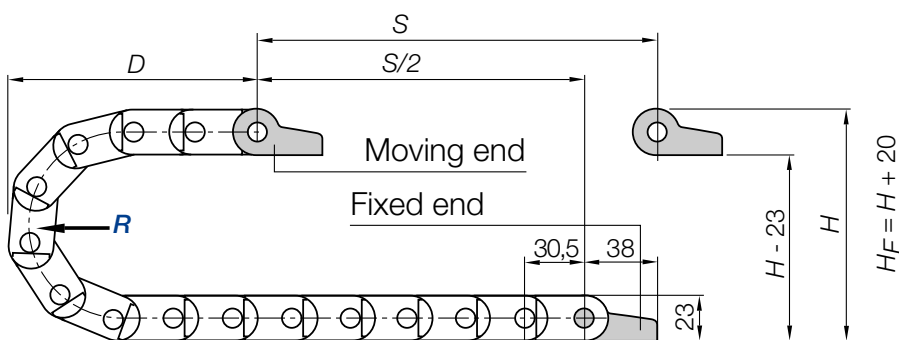

R	038	048	075	100	110	125	145	180
H	99	119	173	223	243	273	313	383
D	95	105	132	157	167	182	202	237
K	185	215	300	380	410	455	520	630

The required clearance height: $H_F = H + 20$ mm (with 0,5 kg/m fill weight)

- FL_G = with straight upper run
- FL_B = with permitted sag
- S = Length of travel
- R = Bending radius
- H = Nominal clearance height
- H_F = Required clearance height
- D = Overlength e-chain®, radius in final position
- $K = \pi \cdot R + \text{"safety"}$



e-chain® | Series 15 | zip-open along outer radius

e-chain® zip-open along outer radius	<i>Bi</i> [mm]	<i>Ba</i> [mm]	<i>R</i> Bending radii [mm]	Weight [kg/m]
15. 015 .R.0	15	26	038 048 075 100 110 125 145 180	≈ 0,35
15. 025 .R.0	25	36	038 048 075 100 110 125 145 180	≈ 0,40
15. 038 .R.0	38	49	038 048 075 100 110 125 145 180	≈ 0,46
15. 050 .R.0	50	61	038 048 075 100 110 125 145 180	≈ 0,52
15. 5 .R.0	63	76	038 048 075 100 110 125 145 180	≈ 0,63
15. 6 .R.0	80	94	038 048 075 100 110 125 145 180	≈ 0,70
15. 7 .R.0	100	113	038 048 075 100 110 125 145 180	≈ 0,76

Supplement Part No. with required radius (*R*) Example: 15.025.038.0

Order key 15. 025. 038. 0 e-chain®

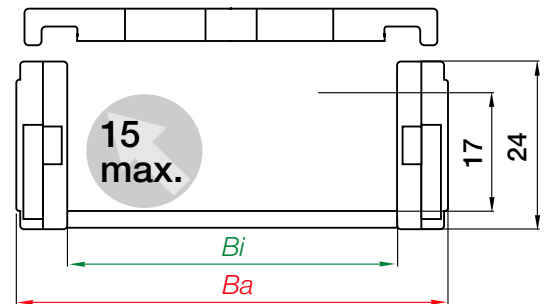
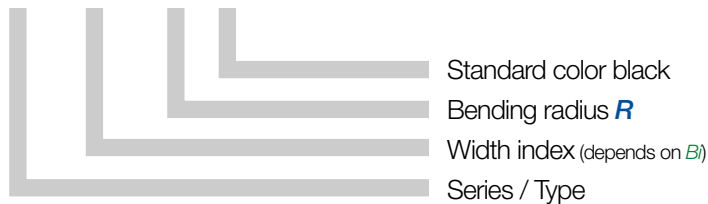



 15.025.038.0 = e-chain® zip-open along outer radius, *Bi* 25 mm inner width, *R* 038 mm radius, color black
More order examples and configuration options ► page 4.45

 Part No. of e-chain® links as single parts ► page 4.7

 Standard e-chains® available from stock. Delivery in 24h or today!*

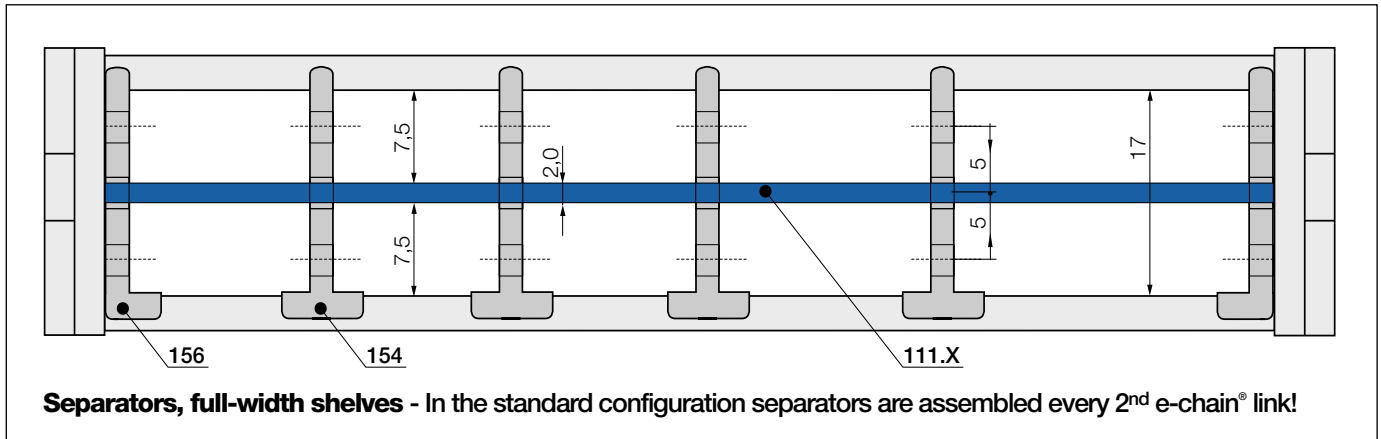
*Delivery time means time until shipping of goods

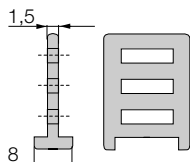
Slotted separator for e-chains®
 unassembled **153**
 assembled **154**

Slotted separator 153

is used when vertical and horizontal separation is required. Due to its slot, it allows basic vertical/horizontal shelving arrangements.

Side plate for e-chains®
 unassembled **155**
 assembled **156**

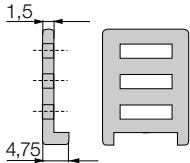
Side plate 155

Side plate for use with full-width shelf 110.X and slotted separator 153.

Full-width shelf for e-chains®
 unassembled **110.X**
 assembled **111.X**

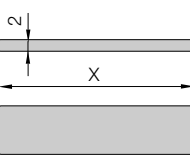
Full-width shelf 110.X

this option makes sense in applications with many thin cables with similar diameters. For a consequent subdivision. Full-width shelves can be arranged at 3 different heights (in 5 mm increments).

Full-width shelves

Width X [mm]	unassembled	assembled	Width X [mm]	unassembled	assembled	Width X [mm]	unassembled	assembled
015	110.15	111.15	050	110.50	111.50	100	110.100	111.100
025	110.25	111.25	063	110.63	111.63			
038	110.38	111.38	080	110.80	111.80			

zipper | e-chains® | Series 15 | Mounting brackets pivoting

For tight installation conditions

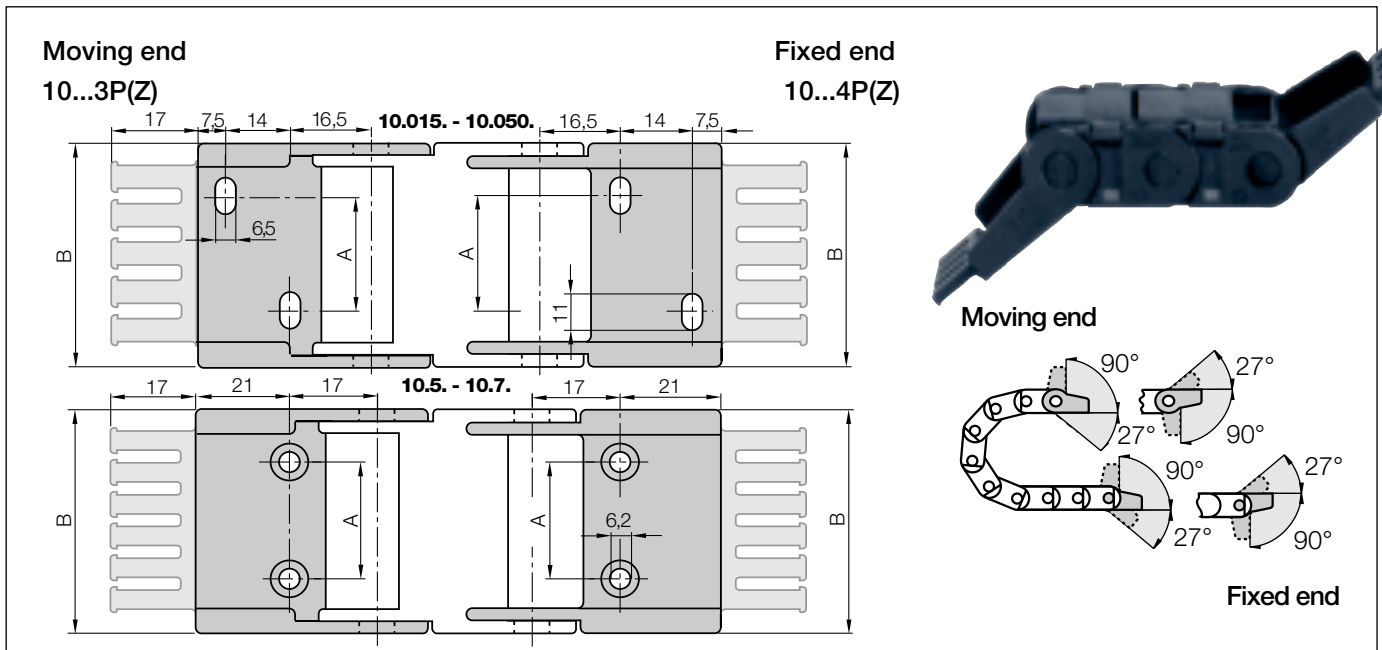

Polymer pivoting, one-piece | Standard | Universal for e-chains®
Recommended for unsupported and gliding applications

Width Index	Part No. full set with tiewrap plates	Part No. full set without tiewrap plates	Dim. A [mm]	Dim. B [mm]	Number of teeth
015.	▶ 1015.34PZ	1015.34P	–	25,5	2
025.	▶ 1025.34PZ	1025.34P	10	35,5	3
038.	▶ 1038.34PZ	1038.34P	23	48,5	4
050.	▶ 1050.34PZ	1050.34P	35	60,5	5
5.	▶ 105. 34PZ	105. 34P	48	75,0	6
6.	▶ 106. 34PZ	106. 34P	65	92,0	8
7.	▶ 107. 34PZ	107. 34P	85	112,0	10

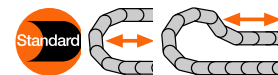

- Standard
- For tight installation conditions
- Strain relief with detachable tiewrap plates
- Variable traverse angle
- Corrosion-resistant
- Various installation options on the fixed end and/or the moving end

Part No. structure

1025. 34 PZ A1



A... must be indicated on preassembled configurations
Strain relief with chainfix tiewrap plates
Full set pivoting = 34
Mounting brackets for selected width index

Single-part order

Mounting bracket **Moving end**

1025. 3 PZ A1 (preass. + tiewrap plate)

Mounting bracket **Fixed end**

1025. 4 PZ A1 (preass. + tiewrap plate)

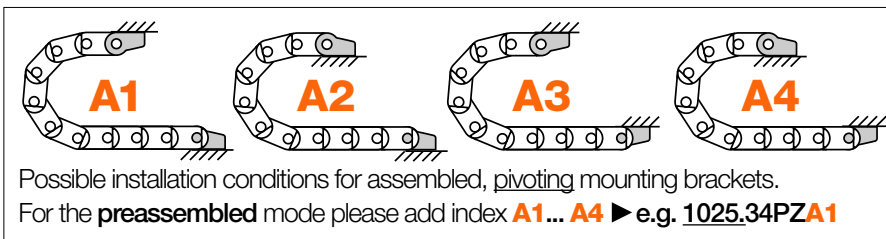

Strain relief, e.g. clamps, tiewrap plates, nuggets and plug-in clips are available from stock. The complete chainfix range with order options ▶ from page 10.1

For very high speed and acceleration

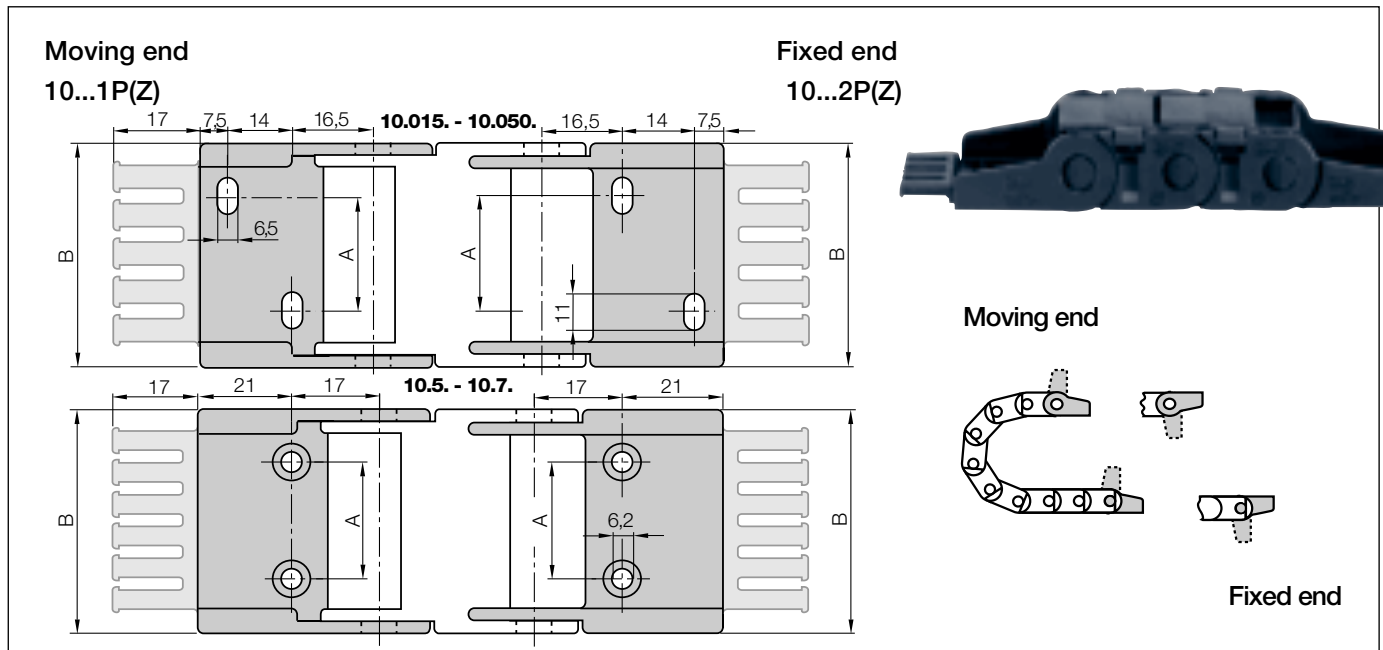

Polymer locking, one-piece | Universal for e-chains®
Recommended for unsupported applications

Width Index	Part No. full set with tiewrap plates	Part No. full set without tiewrap plates	Dim. A [mm]	Dim. B [mm]	Number of teeth
015.	▶ 1015.12PZ	1015.12P	–	25,5	2
025.	▶ 1025.12PZ	1025.12P	10	35,5	3
038.	▶ 1038.12PZ	1038.12P	23	48,5	4
050.	▶ 1050.12PZ	1050.12P	35	60,5	5
5.	▶ 105. 12PZ	105. 12P	48	75,0	6
6.	▶ 106. 12PZ	106. 12P	65	92,0	8
7.	▶ 107. 12PZ	107. 12P	85	112,0	10

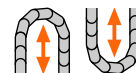

- Locked connections
- At very high speed and/or acceleration
- If space is limited for height (the H_F measurement)
- Various installation options on the fixed end and/or the moving end

Part No. structure (locking)

1025. 12 PZ A1

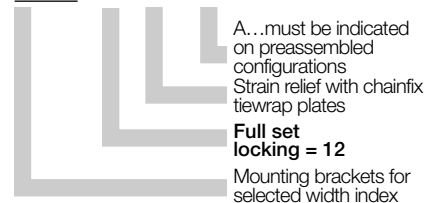

Single-part order

Mounting bracket **Moving end**

1025. 1 PZ A1 (preass. + tiewrap plate)

Mounting bracket **Fixed end**

1025. 2 PZ A1 (preass. + tiewrap plate)

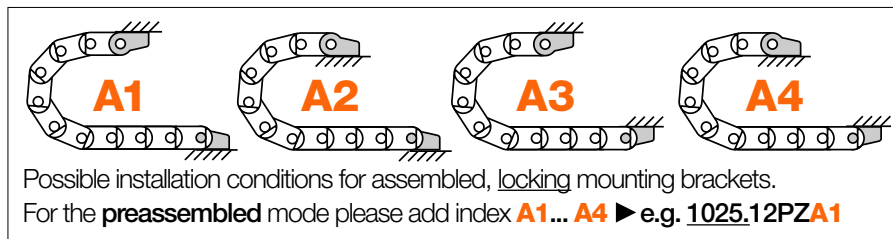

 **Strain relief**, e.g. clamps, tiewrap plates, nuggets and plug-in clips are available from stock. The complete chainfix range with order options ▶ from page 10.1

Aluminum "SuperTrough" | Basic Version

Installation set "Basic" with C-Profile

Bottom Clamp optionally attached inwards or outwards

15.025.038.0 ► Order example

	B_{Ri} [mm]	Part No. attached inwards	Part No. attached outwards
.015	30	-	960.30.125
.025	40	-	960.30.150
.038	53	-	960.30.150
.050	65	960.30.125	960.30.175
.5	80	960.30.125	960.30.175
.6	98	960.30.150	960.30.200
.7	117	960.30.175	960.30.225

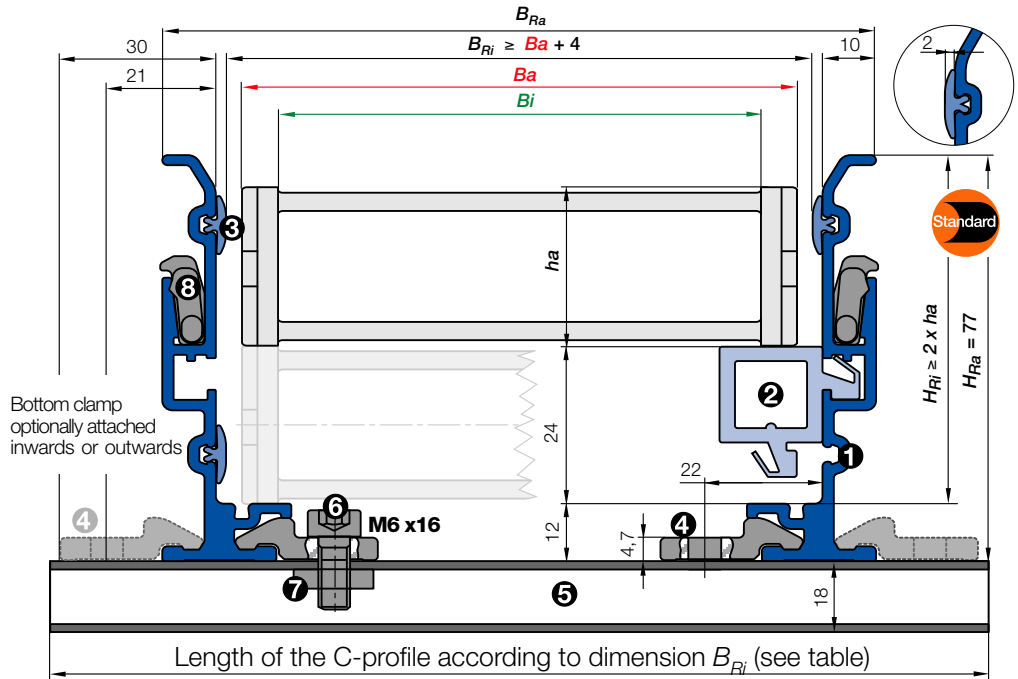

- **Components, trough "Basic":** ① Trough side parts, aluminum, 2 m ② Glide bar, plastic, 2 m ③ Glide strips, plastic, 2 m (without glide strips on request)
- **Components, installation set "Basic":** ④ Bottom clamp, aluminum ⑤ C-profile, galvanized steel ► table ⑥ Screw M6 x 16 ⑦ Sliding nut M6 ⑧ Interface connector, plastic



Order example: Length of travel 30 m -

Center mounted for Series 15.025.038.0 with $B_{Ri} = 40$

Guide trough set **without** glide bar (set of 2 trough side parts, incl. glide strips)

Order text: 16 m guide trough without glide bar (8 x 2 m sections) Part No. 970.30.SL

Guide trough set **with** glide bar (set of 2 trough side parts, incl. glide strips)

Order text: 16 m guide trough with glide bar (8 x 2 m sections) Part No. 970.31.SL

Installation set "Basic" complete (guide trough-sets + 1)

Order text: 17 installation sets Part No. 960.30.125

Module for the fixed end ► page 9.16

Order text: 1 set Part No. 970.80

Option: For an additional noise dampening

with silencer profile, please add Index A - Example: Part No. 970.30.SLA

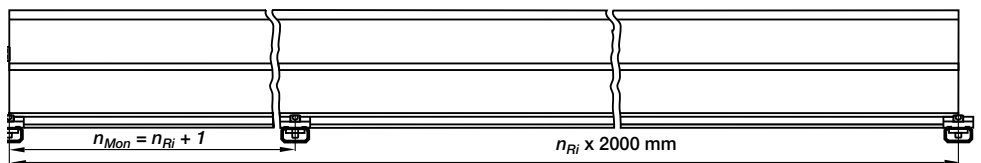

Principle sketch: Number of installation sets to be installed = Number of trough sections + 1



● Trough set

● Installation set

● Glide bar

● C-profile

● B_a = Outer width e-chains*

● B_i = Inner width e-chains*

B_{Ri} = Inner trough width







B_{Ra} = Outer trough width

H_{Ri} = Inner trough height

H_{Ra} = Outer trough height

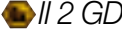
n_{Mon} = Number of installation sets

n_{Ri} = Number of trough sets



<p>i <i>Standard</i></p> <p>Part No. Standard e-chains®</p> 	<p>NC-Version - (no camber) without pretension</p> <p>Part No. NC-Material e-chains®</p> <p>NC</p> 	<p>ATEX / ESD classified e-chains®</p>  <p>Part No. ESD-Material e-chains®</p> 
<p> 15.025.R.0</p>	<p>15.025.R.0.NC</p>	<p>15.025.R.0.ESD</p>
<p> Delivery time 24h or today!*</p>	<p>Delivery time 3-5 work days</p>	<p>Delivery time 5 work days</p>

Order example | Order key and color options

 **Order example for complete e-chain® (1,0 m), color black, with mounting brackets and interior separation:**

e-chain® (1,0 m)	Please indicate e-chain® length or number of links: 1,0 m or 33 links	15.025.038.0
+ Mounting brackets	1 set (with integrated strain relief)	1025.34PZ
+ Interior separation	with 2 separators assembled every 2 nd link	2 x 154

Order text: 1,0 m 15.025.038.0 + 1025.34PZ + 2 x 154

<p> Order key 15.025.038.0</p> 	<p>Color options for e-chains® and e-tubes</p> <table border="1"> <thead> <tr> <th>Color</th> <th>Order index</th> <th>Color</th> <th>Order index</th> </tr> </thead> <tbody> <tr> <td> black</td> <td>.0 from stock!</td> <td> green*</td> <td>.7</td> </tr> <tr> <td> white*</td> <td>.1</td> <td> grey*</td> <td>.3 for e-chains®</td> </tr> <tr> <td> violet*</td> <td>.5</td> <td> dusty grey*</td> <td>.3 for e-tubes</td> </tr> <tr> <td> yellow*</td> <td>.4</td> <td> agate grey*</td> <td>.11</td> </tr> <tr> <td> orange*</td> <td>.2</td> <td> light grey*</td> <td>.14</td> </tr> <tr> <td> red*</td> <td>.6</td> <td> black grey*</td> <td>.13</td> </tr> <tr> <td> blue*</td> <td>.8</td> <td> yellow/black*</td> <td>.9</td> </tr> </tbody> </table>	Color	Order index	Color	Order index	black	.0 from stock!	green*	.7	white*	.1	grey*	.3 for e-chains®	violet*	.5	dusty grey*	.3 for e-tubes	yellow*	.4	agate grey*	.11	orange*	.2	light grey*	.14	red*	.6	black grey*	.13	blue*	.8	yellow/black*	.9
Color	Order index	Color	Order index																														
black	.0 from stock!	green*	.7																														
white*	.1	grey*	.3 for e-chains®																														
violet*	.5	dusty grey*	.3 for e-tubes																														
yellow*	.4	agate grey*	.11																														
orange*	.2	light grey*	.14																														
red*	.6	black grey*	.13																														
blue*	.8	yellow/black*	.9																														

Black e-chains® from stock!
*Colored e-chains® delivered in 15 work days (Delivery in 5 work days at an express surcharge, available upon request!)

 **Available from stock. Delivery in 24h or today!***
*Delivery time means time until shipping of goods