

CMOS LDO Regulator Series for Portable Equipments

# Versatile Package FULL CMOS LDO Regulator



## BUxxTD3WG series

### ●General Description

BUxxTD3WG series is high-performance FULL CMOS regulator with 200-mA output, which is mounted on versatile package SSOP5 (2.9 mm × 2.8 mm × 1.25 mm). It has excellent noise characteristics and load responsiveness characteristics despite its low circuit current consumption of 35μA. It is most appropriate for various applications such as power supplies for logic IC, RF, and camera modules.ROHM's.

### ●Features

- High accuracy detection
- low current consumption
- Compatible with small ceramic capacitor(Cin=Co=0.47μF)
- With built-in output discharge circuit
- High ripple rejection
- ON/OFF control of output voltage
- With built-in over current protection circuit and thermal shutdown circuit
- Package SSOP5 is similar to SOT-23-5 (JEDEC)
- Low dropout voltage

### ●Key Specifications

- Output voltage: 1.0V to 3.4V
- Accuracy output voltage: ±1.0% (±25mV)
- Low current consumption: 35μA
- Operating temperature range: -40°C to +85°C

### ●Applications

Battery-powered portable equipment, etc.

### ●Package

SSOP5: 2.90mm x 2.80mm x 1.25mm



### ●Typical Application Circuit

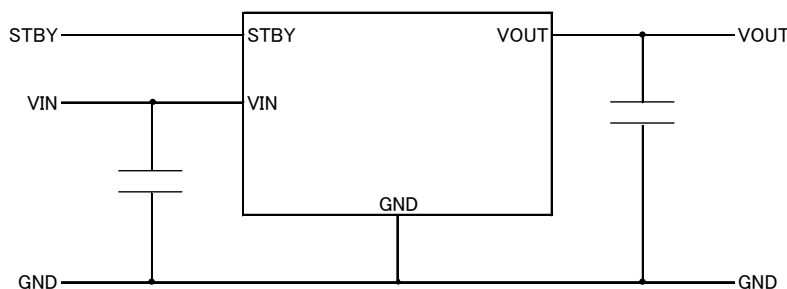
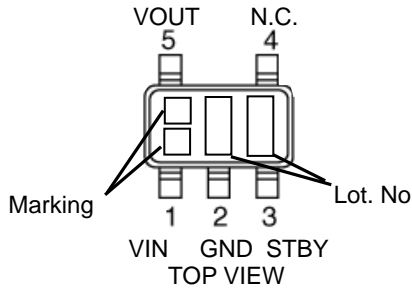

Fig.1 Application Circuit

○Product structure:Silicon monolithic integrated circuit ○This product is not designed protection against radioactive rays.

● Connection Diagram

SSOP5



● Pin Descriptions

| SSOP5   |        |  |
|---------|--------|--|
| PIN No. | Symbol | Function   |
| 1       | VIN    | Power Supply Voltage                                     |
| 2       | GND    | Grounding  |
| 3       | STBY   | ON/OFF control of output voltage<br>(High: ON, Low: OFF) |
| 4       | N.C.   | Unconnected Terminal                                     |
| 5       | VOUT   | Output Voltage   |

● Ordering Information

|   |   |   |   |   |   |   |   |   |   |   |   |   |
|---|---|---|---|---|---|---|---|---|---|---|---|---|
| B | U | x | x | T | D | 3 | W | G | - | x | T | R |
|---|---|---|---|---|---|---|---|---|---|---|---|---|

|             |   |   |                          |                      |  |  |
|-------------|---|---|--------------------------|----------------------|--|--|
| Part Number | Output Voltage<br>10 : 1.0V<br>↓<br>34 : 3.4V | Series<br>Maximum Output Current<br>200mA | with<br>output discharge | Package<br>G : SSOP5 | Halogen Free<br>G : compatible<br>Blank : incompatible | Packageing and forming specification<br>Embossed tape and reel<br>TR : The pin number 1 is the upper right |
|-------------|---|---|--------------------------|----------------------|--|--|

SSOP5

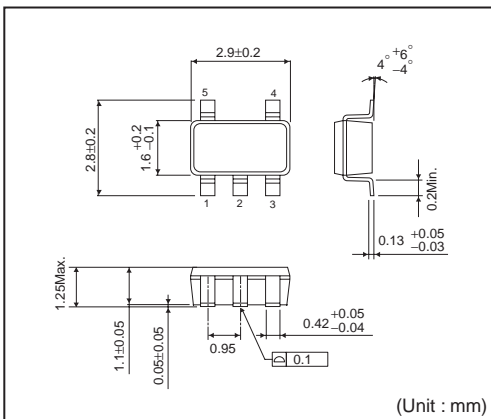

< Tape and Reel Information >

|                   |   |
|-------------------|---|
| Tape              | Embossed carrier tape   |
| Quantity          | 3000pcs   |
| Direction of feed | TR<br>(The direction is the 1pin of product is at the upper right when you hold) reel on the left hand and you pull out the tape on the right hand) |

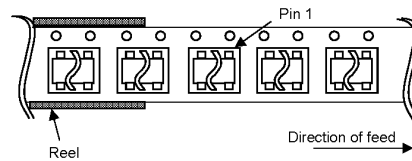

## ●Lineup

|                |      |      |      |       |      |      |      |       |      |
|----------------|------|------|------|-------|------|------|------|-------|------|
| Marking        | F0   | L6   | F1   | M0    | L5   | F2   | F3   | F4    | F5   |
| Output Voltage | 1.0V | 1.1V | 1.2V | 1.25V | 1.3V | 1.5V | 1.8V | 1.85V | 1.9V |
| Part Number    | BU10 | BU11 | BU12 | BU1C  | BU13 | BU15 | BU18 | BU1J  | BU19 |

|      |      |      |      |      |      |       |      |      |
|------|------|------|------|------|------|-------|------|------|
| F6   | F7   | F8   | F9   | G0   | G1   | G2    | G3   | G4   |
| 2.0V | 2.1V | 2.5V | 2.6V | 2.7V | 2.8V | 2.85V | 2.9V | 3.0V |
| BU20 | BU21 | BU25 | BU26 | BU27 | BU28 | BU2J  | BU29 | BU30 |

|      |      |      |      |
|------|------|------|------|
| G5   | G6   | G7   | G8   |
| 3.1V | 3.2V | 3.3V | 3.4V |
| BU31 | BU32 | BU33 | BU34 |

## ●Absolute Maximum Ratings (Ta=25°C)

| PARAMETER                    | Symbol | Limit       | Unit |
|------------------------------|--------|-------------|------|
| Power Supply Voltage         | VMAX   | -0.3 ~ +6.5 | V    |
| Power Dissipation            | Pd     | 540(*1)     | mW   |
| Maximum junction temperature | TjMAX  | +125        | °C   |
| Operating Temperature Range  | Topr   | -40 ~ +85   | °C   |
| Storage Temperature Range    | Tstg   | -55 ~ +125  | °C   |

(\*1)Pd deleted at 5.4mW/°C at temperatures above Ta=25°C, mounted on 70x70x1.6 mm glass-epoxy PCB.

## ●RECOMMENDED OPERATING RANGE (not to exceed Pd)

| PARAMETER              | Symbol | Limit   | Unit |
|------------------------|--------|---------|------|
| Power Supply Voltage   | VIN    | 1.7~6.0 | V    |
| Maximum Output Current | IMAX   | 200     | mA   |

## ●OPERATING CONDITIONS

| PARAMETER        | Symbol | MIN.      | TYP. | MAX. | Unit | CONDITION                     |
|------------------|--------|-----------|------|------|------|-------------------------------|
| Input Capacitor  | Cin    | 0.22 (*2) | 0.47 | -    | μF   | Ceramic capacitor recommended |
| Output Capacitor | Co     | 0.22 (*2) | 0.47 | -    | μF   |                               |

(\*2)Make sure that the output capacitor value is not kept lower than this specified level across a variety of temperature, DC bias, changing as time progresses characteristic.

●Electrical Characteristics

(Ta=25°C, VIN=VOUT+1.0V (\*3), STBY=VIN, Cin=0.47μF, Co=0.47μF, unless otherwise noted.)

| PARAMETER                            | Symbol | Limit                 |      |                                | Unit | Conditions                            |
|--------------------------------------|--------|-----------------------|------|--------------------------------|------|---------------------------------------|
|                                      |        | MIN.                  | TYP. | MAX.                           |      |                                       |
| <b>Overall Device</b>                |        |                       |      |                                |      |                                       |
| Output Voltage                       | VOUT   | $V_{OUT} \times 0.99$ | VOUT | $V_{OUT} \times 1.01$          | V    | IOUT=10μA, VOUT ≥ 2.5V                |
|                                      |        | VOUT-25mV             |      | VOUT+25mV                      |      | IOUT=10μA, VOUT < 2.5V                |
| Operating Current                    | IIN    | -                     | 35   | 60                             | μA   | IOUT=0mA                              |
| Operating Current (STBY)             | ISTBY  | -                     | -    | 1.0                            | μA   | STBY=0V                               |
| Ripple Rejection Ratio               | RR     | 45                    | 70   | -                              | dB   | VRR=-20dBv, fRR=1kHz, IOUT=10mA       |
| Dropout Voltage                      | VSAT   | -                     | 800  | 1100                           | mV   | 1.0V ≤ VOUT < 1.2V(IOUT=200mA)        |
|                                      |        | -                     | 600  | 900                            | mV   | 1.2V ≤ VOUT < 1.5V(IOUT=200mA)        |
|                                      |        | -                     | 440  | 700                            | mV   | 1.5V ≤ VOUT < 1.8V(IOUT=200mA)        |
|                                      |        | -                     | 380  | 600                            | mV   | 1.8V ≤ VOUT < 2.5V(IOUT=200mA)        |
|                                      |        | -                     | 280  | 540                            | mV   | 2.5V ≤ VOUT ≤ 2.6V(IOUT=200mA)        |
|                                      |        | -                     | 260  | 500                            | mV   | 2.7V ≤ VOUT ≤ 2.85V(IOUT=200mA)       |
|                                      |        | -                     | 240  | 460                            | mV   | 2.9V ≤ VOUT ≤ 3.1V(IOUT=200mA)        |
| -                                    | 220    | 420                   | mV   | 3.2V ≤ VOUT ≤ 3.4V(IOUT=200mA) |      |                                       |
| Line Regulation                      | VDL    | -                     | 2    | 20                             | mV   | VIN=VOUT+1.0V to 5.5V (*4), IOUT=10μA |
| Load Regulation                      | VDLO   | -                     | 10   | 80                             | mV   | IOUT=0.01mA to 100mA                  |
| <b>Over Current Protection (OCP)</b> |        |                       |      |                                |      |                                       |
| Limit Current                        | ILMAX  | 220                   | 400  | 700                            | mA   | Vo=VOUT*0.95                          |
| Short Current                        | ISHORT | 20                    | 70   | 150                            | mA   | Vo=0V                                 |
| <b>Standby Block</b>                 |        |                       |      |                                |      |                                       |
| Discharge Resistor                   | RDSC   | 20                    | 50   | 80                             | Ω    | VIN=4.0V, STBY=0V, VOUT=4.0V          |
| STBY Pin Pull-down Current           | ISTB   | 0.1                   | 0.6  | 2.0                            | μA   | STBY=1.5V                             |
| STBY Control Voltage                 | ON     | VSTBH                 | 1.2  | -                              | 6.0  | V                                     |
|                                      | OFF    | VSTBL                 | -0.3 | -                              | 0.3  | V                                     |

This product is not designed for protection against radioactive rays.

(\*3) VIN=2.5V for VOUT ≤ 1.5V

(\*4) VIN=2.5V to 3.6V for VOUT ≤ 1.5V

●Block Diagrams

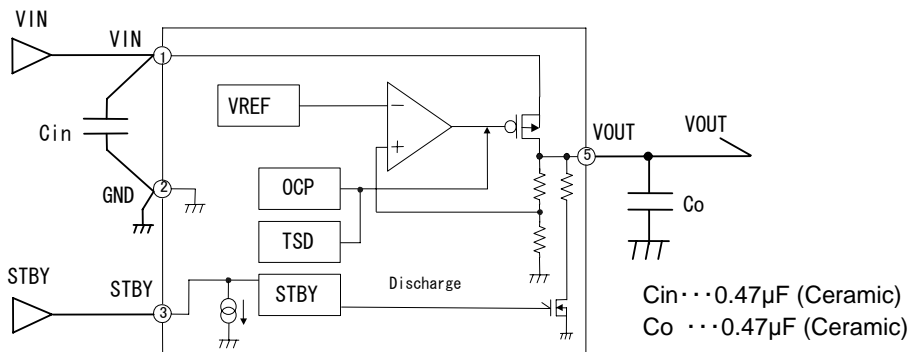

Fig. 2 Block Diagrams

●Reference data BU18TD3WG (Ta=25°C unless otherwise specified.)

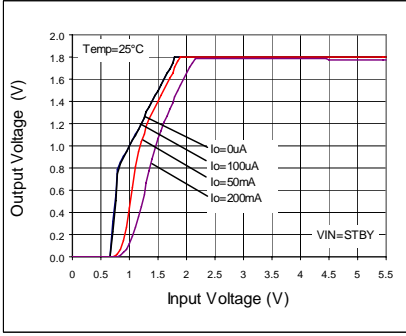

Fig 3. Output Voltage

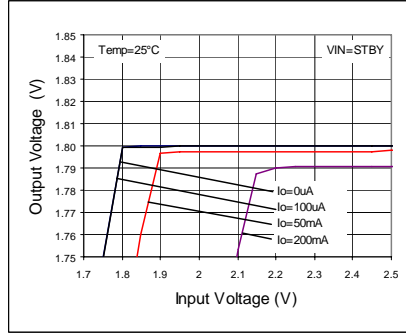

Fig 4. Line Regulation

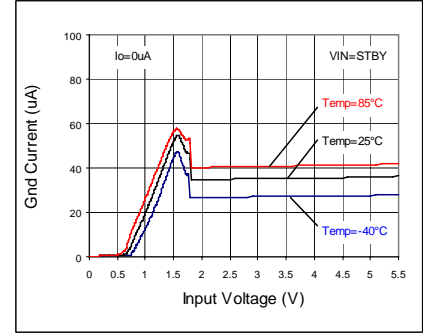

Fig 5. Circuit Current IGND

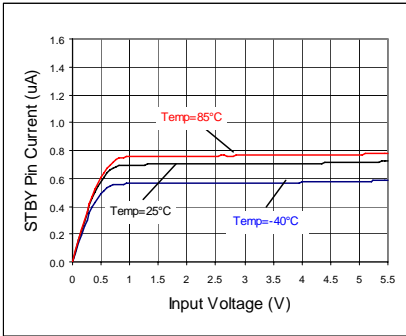

Fig 6. VSTBY - ISTBY

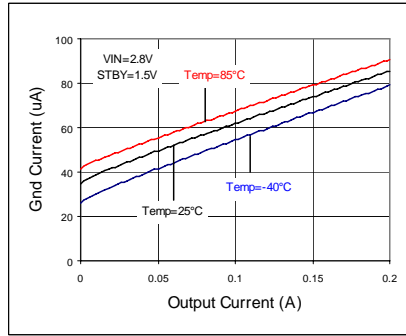

Fig 7. IOU - IGND

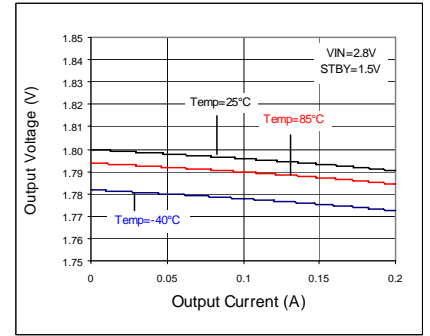

Fig 8. Load Regulation

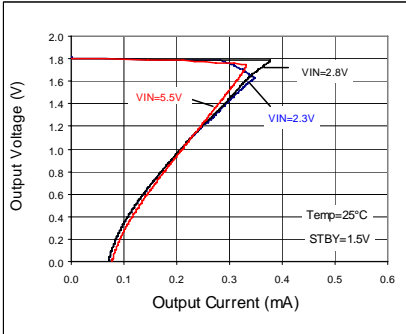

Fig 9. OCP Threshold

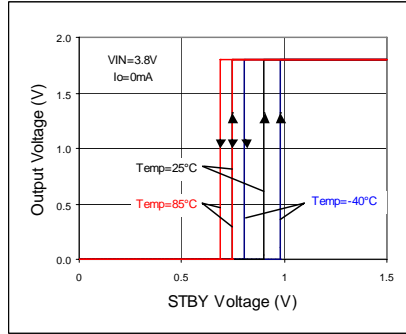

Fig 10. STBY Threshold

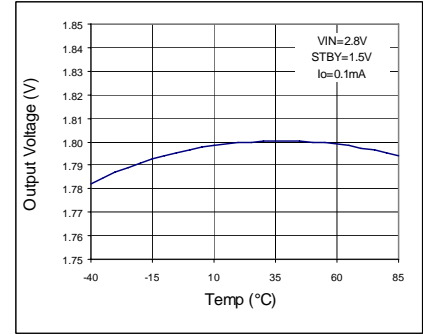

Fig 11. VOUT - Temp

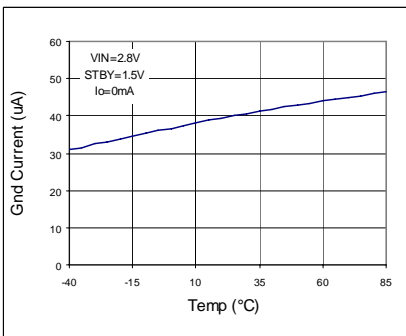

Fig 12. IGND - Temp

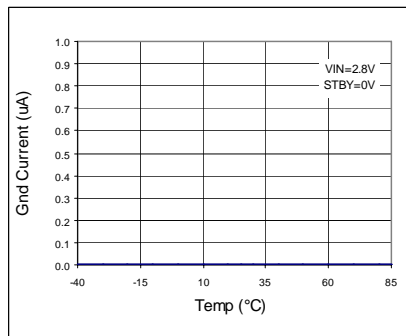

Fig 13. IGND - Temp (STBY)

●Reference data **BU18TD3WG** (Ta=25°C unless otherwise specified.)

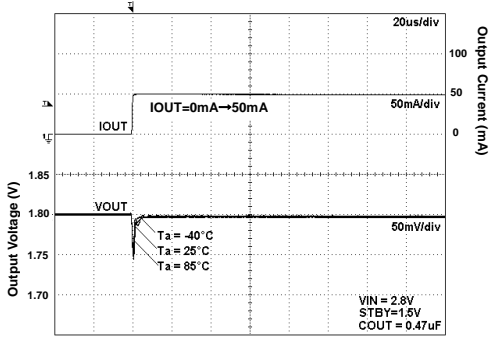

Fig 14. Load Response

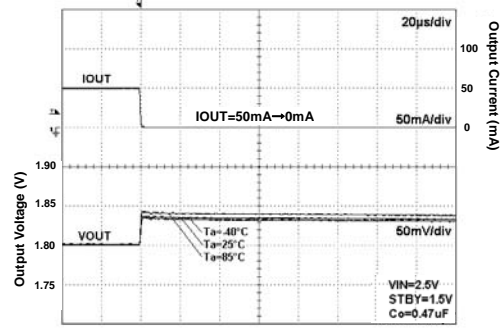

Fig 15. Load Response

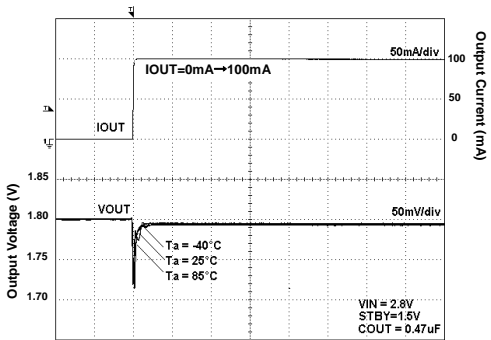

Fig 16. Load Response

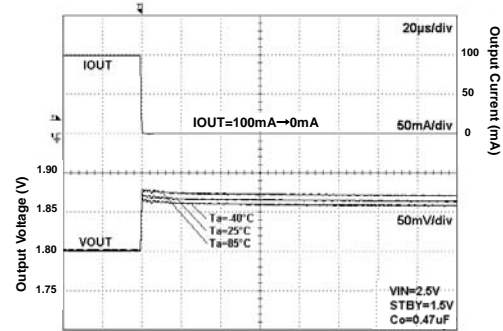

Fig 17. Load Response

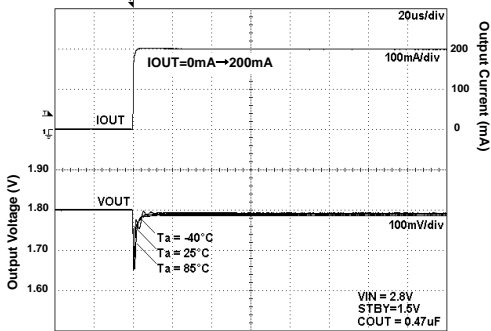

Fig 18. Load Response

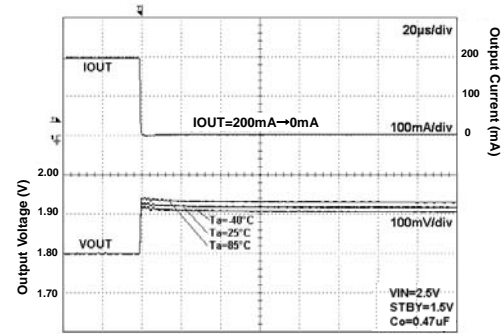

Fig 19. Load Response

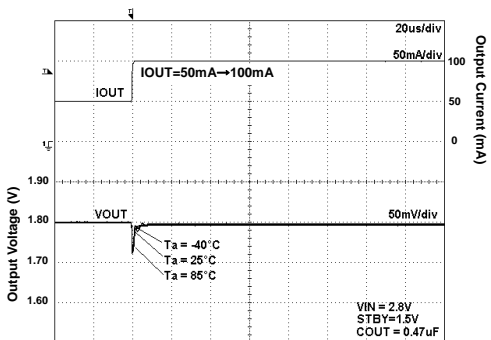

Fig 20. Load Response

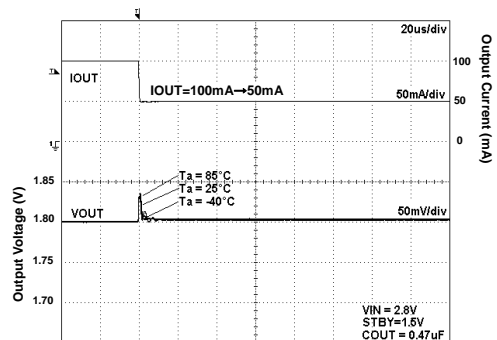

Fig 21. Load Response

●Reference data BU18TD3WG (Ta=25°C unless otherwise specified.)

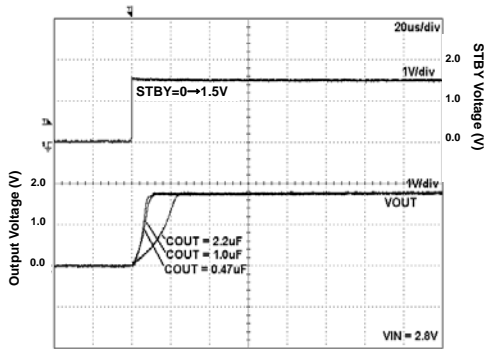

Fig 22. Start Up Time  
Iout=0mA

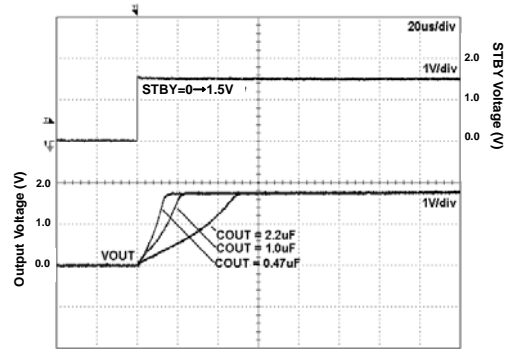

Fig 23. Start Up Time  
Iout=200mA

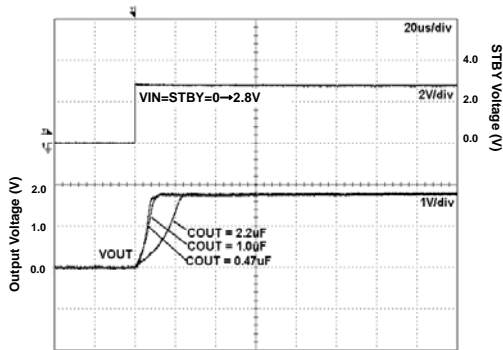

Fig 24. Start Up Time  
(VIN=STBY) Iout=0mA

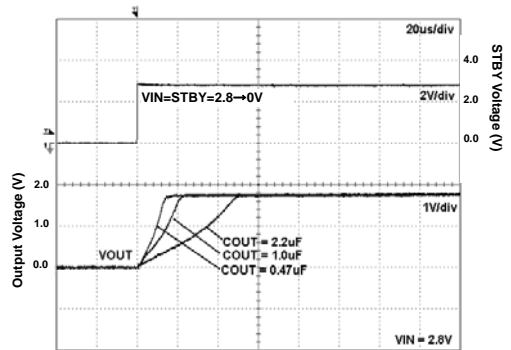

Fig 25. Start Up Time  
(VIN=STBY) Iout=200mA

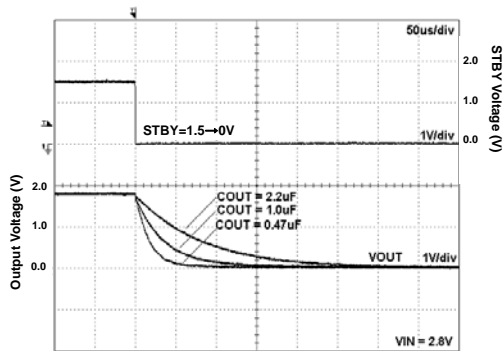

Fig 26. Discharge Time

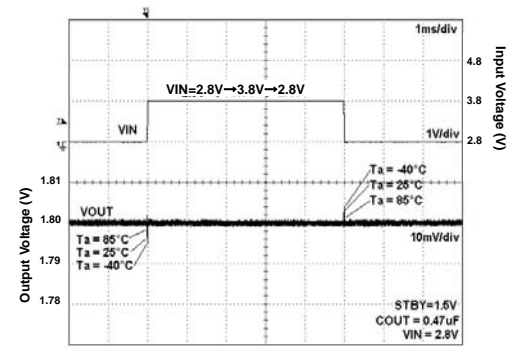

Fig 27. VIN Response

● About power dissipation (Pd)

As for power dissipation, an approximate estimate of the heat reduction characteristics and internal power consumption of IC are shown, so please use these for reference. Since power dissipation changes substantially depending on the implementation conditions (board size, board thickness, metal wiring rate, number of layers and through holes, etc.), it is recommended to measure Pd on a set board. Exceeding the power dissipation of IC may lead to deterioration of the original IC performance, such as causing operation of the thermal shutdown circuit or reduction in current capability. Therefore, be sure to prepare sufficient margin within power dissipation for usage.

Calculation of the maximum internal power consumption of IC (P<sub>MAX</sub>)

$$P_{MAX} = (V_{IN} - V_{OUT}) \times I_{OUT(MAX)}$$

(V<sub>IN</sub>: Input voltage V<sub>OUT</sub>: Output voltage I<sub>OUT(MAX)</sub>: Maximum output current)

○ Measurement conditions

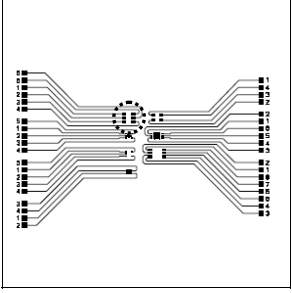
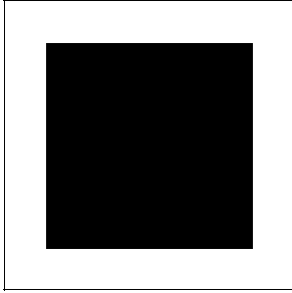
|                                 |   |                                      |
|---------------------------------|---|--------------------------------------|
|                                 |   | Standard ROHM Board                  |
| Layout of Board for Measurement |   |                                      |
|                                 | Top Layer (Top View)  |                                      |
| IC Implementation Position      |  |                                      |
|                                 | Bottom Layer (Top View)   |                                      |
| Measurement State               | With board implemented (Wind speed 0 m/s)   |                                      |
| Board Material                  | Glass epoxy resin (Double-side board)   |                                      |
| Board Size                      | 70 mm x 70 mm x 1.6 mm  |                                      |
| Wiring Rate                     | Top layer   | Metal (GND) wiring rate: Approx. 0%  |
|                                 | Bottom layer  | Metal (GND) wiring rate: Approx. 50% |
| Through Hole                    | Diameter 0.5mm x 6 holes  |                                      |
| Power Dissipation               | 0.54W   |                                      |
| Thermal Resistance              | θ <sub>ja</sub> =185.2°C/W  |                                      |

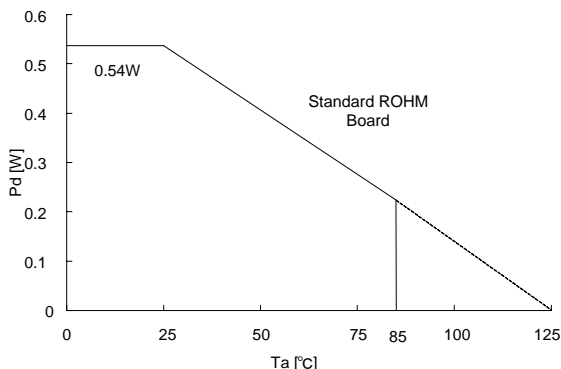

\* Please design the margin so that P<sub>MAX</sub> becomes is than Pd (P<sub>MAX</sub><Pd) within the usage temperature range

Fig. 28 SSOP5 Power dissipation heat reduction characteristics (Reference)



●Operation Notes

1.) **Absolute maximum ratings**

Use of the IC in excess of absolute maximum ratings (such as the input voltage or operating temperature range) may result in damage to the IC. Assumptions should not be made regarding the state of the IC (e.g., short mode or open mode) when such damage is suffered. If operational values are expected to exceed the maximum ratings for the device, consider adding protective circuitry (such as fuses) to eliminate the risk of damaging the IC.

2.) **GND potential**

The potential of the GND pin must be the minimum potential in the system in all operating conditions. Never connect a potential lower than GND to any pin, even if only transiently.

3.) **Thermal design**

Use a thermal design that allows for a sufficient margin for that package power dissipation rating (Pd) under actual operating conditions.

4.) **Inter-pin shorts and mounting errors**

Use caution when orienting and positioning the IC for mounting on printed circuit boards. Improper mounting or shorts between pins may result in damage to the IC.

5.) **Operation in strong electromagnetic fields**

Strong electromagnetic fields may cause the IC to malfunction. Caution should be exercised in applications where strong electromagnetic fields may be present.

6.) **Common impedance**

Wiring traces should be as short and wide as possible to minimize common impedance. Bypass capacitors should be used to keep ripple to a minimum.

7.) **Voltage of STBY pin**

To enable standby mode for all channels, set the STBY pin to 0.3 V or less, and for normal operation, to 1.2 V or more. Setting STBY to a voltage between 0.3 and 1.2 V may cause malfunction and should be avoided. Keep transition time between high and low (or vice versa) to a minimum.

Additionally, if STBY is shorted to VIN, the IC will switch to standby mode and disable the output discharge circuit, causing a temporary voltage to remain on the output pin. If the IC is switched on again while this voltage is present, overshoot may occur on the output. Therefore, in applications where these pins are shorted, the output should always be completely discharged before turning the IC on.

8.) **Over-current protection circuit (OCP)**

This IC features an integrated over-current and short-protection circuitry on the output to prevent destruction of the IC when the output is shorted. The OCP circuitry is designed only to protect the IC from irregular conditions (such as motor output shorts) and is not designed to be used as an active security device for the application. Therefore, applications should not be designed under the assumption that this circuitry will engage.

9.) **Thermal shutdown circuit (TSD)**

This IC also features a thermal shutdown circuit that is designed to turn the output off when the junction temperature of the IC exceeds about 150°C. This feature is intended to protect the IC only in the event of thermal overload and is not designed to guarantee operation or act as an active security device for the application. Therefore, applications should not be designed under the assumption that this circuitry will engage.

10.) **Input/output capacitor**

Capacitors must be connected between the input/output pins and GND for stable operation, and should be physically mounted as close to the IC pins as possible. The input capacitor helps to counteract increases in power supply impedance, and increases stability in applications with long or winding power supply traces. The output capacitance value is directly related to the overall stability and transient response of the regulator, and should be set to the largest  $\mu$ Unstable region $\mu$  on the application to increase these characteristics. During design, keep in mind that in general, ceramic capacitors have a wide range of tolerances, temperature coefficients and DC bias characteristics, and that their capacitance values tend to decrease over time. Confirm these details before choosing appropriate capacitors for your application. (Please refer the technical note, regarding ceramic capacitor of recommendation)

11.) **About the equivalent series resistance (ESR) of a ceramic capacitor**

Capacitors generally have ESR (equivalent series resistance) and it operates stably in the ESR-IOUT area shown on the right. Since ceramic capacitors, tantalum capacitors, electrolytic capacitors, etc. generally have different ESR, please check the ESR of the capacitor to be used and use it within the stability area range shown in the right graph for evaluation of the actual application.

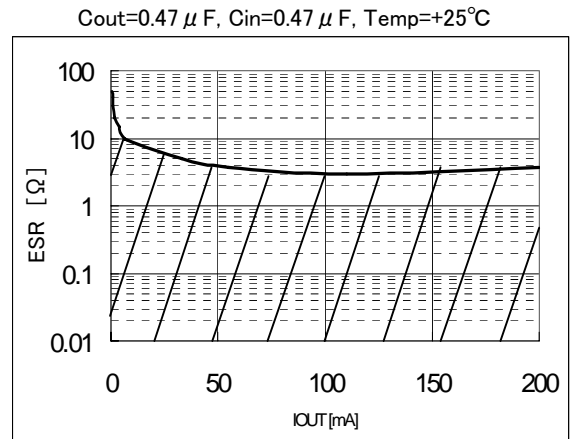

Fig. 29 Stable region (example)

## ●Revision History

| Date        | Revision | Changes  |
|-------------|----------|--|
| 7.Feb.2013  | 001      | New Release  |
| 30.Jul.2013 | 002      | Adding a Revision History.<br>VSBYH is changed.  |
| 21.AUG.2013 | 003      | ELECTRICAL CHARACTERISTICS of each Output Voltage is removed.<br>Adding dropout voltage. |

# Notice

## Precaution on using ROHM Products

- Our Products are designed and manufactured for application in ordinary electronic equipments (such as AV equipment, OA equipment, telecommunication equipment, home electronic appliances, amusement equipment, etc.). If you intend to use our Products in devices requiring extremely high reliability (such as medical equipment <sup>(Note 1)</sup>, transport equipment, traffic equipment, aircraft/spacecraft, nuclear power controllers, fuel controllers, car equipment including car accessories, safety devices, etc.) and whose malfunction or failure may cause loss of human life, bodily injury or serious damage to property ("Specific Applications"), please consult with the ROHM sales representative in advance. Unless otherwise agreed in writing by ROHM in advance, ROHM shall not be in any way responsible or liable for any damages, expenses or losses incurred by you or third parties arising from the use of any ROHM's Products for Specific Applications.

(Note1) Medical Equipment Classification of the Specific Applications

| JAPAN     | USA       | EU         | CHINA     |
|-----------|-----------|------------|-----------|
| CLASS III | CLASS III | CLASS II b | CLASS III |
| CLASS IV  |           | CLASS III  |           |

- ROHM designs and manufactures its Products subject to strict quality control system. However, semiconductor products can fail or malfunction at a certain rate. Please be sure to implement, at your own responsibilities, adequate safety measures including but not limited to fail-safe design against the physical injury, damage to any property, which a failure or malfunction of our Products may cause. The following are examples of safety measures:
  - Installation of protection circuits or other protective devices to improve system safety
  - Installation of redundant circuits to reduce the impact of single or multiple circuit failure
- Our Products are designed and manufactured for use under standard conditions and not under any special or extraordinary environments or conditions, as exemplified below. Accordingly, ROHM shall not be in any way responsible or liable for any damages, expenses or losses arising from the use of any ROHM's Products under any special or extraordinary environments or conditions. If you intend to use our Products under any special or extraordinary environments or conditions (as exemplified below), your independent verification and confirmation of product performance, reliability, etc. prior to use, must be necessary:
  - Use of our Products in any types of liquid, including water, oils, chemicals, and organic solvents
  - Use of our Products outdoors or in places where the Products are exposed to direct sunlight or dust
  - Use of our Products in places where the Products are exposed to sea wind or corrosive gases, including Cl<sub>2</sub>, H<sub>2</sub>S, NH<sub>3</sub>, SO<sub>2</sub>, and NO<sub>2</sub>
  - Use of our Products in places where the Products are exposed to static electricity or electromagnetic waves
  - Use of our Products in proximity to heat-producing components, plastic cords, or other flammable items
  - Sealing or coating our Products with resin or other coating materials
  - Use of our Products without cleaning residue of flux (even if you use no-clean type fluxes, cleaning residue of flux is recommended); or Washing our Products by using water or water-soluble cleaning agents for cleaning residue after soldering
  - Use of the Products in places subject to dew condensation
- The Products are not subject to radiation-proof design.
- Please verify and confirm characteristics of the final or mounted products in using the Products.
- In particular, if a transient load (a large amount of load applied in a short period of time, such as pulse. is applied, confirmation of performance characteristics after on-board mounting is strongly recommended. Avoid applying power exceeding normal rated power; exceeding the power rating under steady-state loading condition may negatively affect product performance and reliability.
- De-rate Power Dissipation (Pd) depending on Ambient temperature (Ta). When used in sealed area, confirm the actual ambient temperature.
- Confirm that operation temperature is within the specified range described in the product specification.
- ROHM shall not be in any way responsible or liable for failure induced under deviant condition from what is defined in this document.

## Precaution for Mounting / Circuit board design

- When a highly active halogenous (chlorine, bromine, etc.) flux is used, the residue of flux may negatively affect product performance and reliability.
- In principle, the reflow soldering method must be used; if flow soldering method is preferred, please consult with the ROHM representative in advance.

For details, please refer to ROHM Mounting specification

### Precautions Regarding Application Examples and External Circuits

1. If change is made to the constant of an external circuit, please allow a sufficient margin considering variations of the characteristics of the Products and external components, including transient characteristics, as well as static characteristics.
2. You agree that application notes, reference designs, and associated data and information contained in this document are presented only as guidance for Products use. Therefore, in case you use such information, you are solely responsible for it and you must exercise your own independent verification and judgment in the use of such information contained in this document. ROHM shall not be in any way responsible or liable for any damages, expenses or losses incurred by you or third parties arising from the use of such information.

### Precaution for Electrostatic

This Product is electrostatic sensitive product, which may be damaged due to electrostatic discharge. Please take proper caution in your manufacturing process and storage so that voltage exceeding the Products maximum rating will not be applied to Products. Please take special care under dry condition (e.g. Grounding of human body / equipment / solder iron, isolation from charged objects, setting of ionizer, friction prevention and temperature / humidity control).

### Precaution for Storage / Transportation

1. Product performance and soldered connections may deteriorate if the Products are stored in the places where:
  - [a] the Products are exposed to sea winds or corrosive gases, including Cl<sub>2</sub>, H<sub>2</sub>S, NH<sub>3</sub>, SO<sub>2</sub>, and NO<sub>2</sub>
  - [b] the temperature or humidity exceeds those recommended by ROHM
  - [c] the Products are exposed to direct sunshine or condensation
  - [d] the Products are exposed to high Electrostatic
2. Even under ROHM recommended storage condition, solderability of products out of recommended storage time period may be degraded. It is strongly recommended to confirm solderability before using Products of which storage time is exceeding the recommended storage time period.
3. Store / transport cartons in the correct direction, which is indicated on a carton with a symbol. Otherwise bent leads may occur due to excessive stress applied when dropping of a carton.
4. Use Products within the specified time after opening a humidity barrier bag. Baking is required before using Products of which storage time is exceeding the recommended storage time period.

### Precaution for Product Label

QR code printed on ROHM Products label is for ROHM's internal use only.

### Precaution for Disposition

When disposing Products please dispose them properly using an authorized industry waste company.

### Precaution for Foreign Exchange and Foreign Trade act

Since our Products might fall under controlled goods prescribed by the applicable foreign exchange and foreign trade act, please consult with ROHM representative in case of export.

### Precaution Regarding Intellectual Property Rights

1. All information and data including but not limited to application example contained in this document is for reference only. ROHM does not warrant that foregoing information or data will not infringe any intellectual property rights or any other rights of any third party regarding such information or data. ROHM shall not be in any way responsible or liable for infringement of any intellectual property rights or other damages arising from use of such information or data.:
2. No license, expressly or implied, is granted hereby under any intellectual property rights or other rights of ROHM or any third parties with respect to the information contained in this document.

### Other Precaution

1. This document may not be reprinted or reproduced, in whole or in part, without prior written consent of ROHM.
2. The Products may not be disassembled, converted, modified, reproduced or otherwise changed without prior written consent of ROHM.
3. In no event shall you use in any way whatsoever the Products and the related technical information contained in the Products or this document for any military purposes, including but not limited to, the development of mass-destruction weapons.
4. The proper names of companies or products described in this document are trademarks or registered trademarks of ROHM, its affiliated companies or third parties.

**General Precaution**

1. Before you use our Products, you are requested to carefully read this document and fully understand its contents. ROHM shall not be in any way responsible or liable for failure, malfunction or accident arising from the use of any ROHM's Products against warning, caution or note contained in this document.
2. All information contained in this document is current as of the issuing date and subject to change without any prior notice. Before purchasing or using ROHM's Products, please confirm the latest information with a ROHM sales representative.
3. The information contained in this document is provided on an "as is" basis and ROHM does not warrant that all information contained in this document is accurate and/or error-free. ROHM shall not be in any way responsible or liable for any damages, expenses or losses incurred by you or third parties resulting from inaccuracy or errors of or concerning such information.



BU20TD3WG - Web Page

[Distribution Inventory](#)

|                             |           |
|-----------------------------|-----------|
| Part Number                 | BU20TD3WG |
| Package                     | SSOP5     |
| Unit Quantity               | 3000      |
| Minimum Package Quantity    | 3000      |
| Packing Type                | Taping    |
| Constitution Materials List | inquiry   |
| RoHS                        | Yes       |