

The Robox logo is located in the top right corner. It consists of the word "robox" in a white, lowercase, sans-serif font, enclosed within a blue rounded rectangular shape that resembles a speech bubble or a stylized container.

robox

A large, stylized graphic of an open book is centered on the page. The book is rendered in a light blue color with dark blue outlines, giving it a three-dimensional appearance. The pages are slightly curved, and the spine is visible on the right side. The book is set against a dark grey background.

# User Guide

including AutoMaker™

Version 1.3

[www.cel-robox.com](http://www.cel-robox.com)

<b>1.0 Introduction</b>	<b>6</b>
1.1 Welcome	7
1.2 Learn More	7
1.3 Using This Guide	8
1.4 Instructional Icons	9
1.5 Typography	10
1.6 Important Safety Information	10
Electrical Safety	10
Operation Safety	11
Safety Guidelines	12
1.7 Safety Symbols and Definitions	13
1.8 Legal Notice	14
1.9 Copyright	14
1.10 Declaration of Conformity	15
1.11 Limited Warranty Statement	16
1.12 Regulatory and Environmental Information	17
<b>2.0 Overview</b>	<b>19</b>
2.1 Features	20
2.2 Specifications	20
2.3 Minimum Hardware Requirements	21
2.4 How It Works	22
2.5 At A Glance	23
<b>3.0 Getting Started</b>	<b>25</b>
3.1 Package Contents	26
3.2 Unpacking Robox®	27
3.3 Software Installation	29
3.4 Starting AutoMaker™	31
3.4.1 On Windows	31
3.4.2 On MacOS	31
3.4.3 On Linux	31

3.5 Setting Up Your Robox® Account.....	32
3.6 Attaching the USB Cable .....	33
3.7 Attaching the Power Cable and Powering On.....	33
<b>4.0 Using Robox® .....</b>	<b>34</b>
4.1 Loading Filament .....	35
4.1.1 Preparing the Filament.....	35
4.1.2 Feeding to the Head .....	35
4.1.3 Installing the Reel .....	36
4.2 Unloading Filament.....	37
4.2.1 Pause / Resume / Eject Button.....	37
4.2.2 Removing The Reel.....	38
4.3 Filament Storage.....	38
4.4 The HeadLock™ System .....	39
4.4.1 Removing a Head .....	39
4.4.2 Installing a Head .....	40
4.5 Removing the Bed.....	41
4.6 Installing the Bed .....	41
<b>5.0 AutoMaker Software .....</b>	<b>42</b>
5.1 User Interface .....	43
5.2 Print Workflow .....	44
5.3 Status Screen.....	45
5.3.1 Connected Printers.....	45
5.3.2 Installed Filament.....	46
5.3.3 Temperature Display .....	46
5.3.4 Projects Tabs.....	47
5.3.5 Current Printer Status.....	47
5.3.6 Advanced Settings.....	48
5.3.7 Advanced Settings - SmartReel™ Programming .....	49
5.3.8 Advanced Settings - Head Programming.....	49
5.3.9 Advanced Settings - Calibration and Maintenance .....	50

5.3.10 Advanced Settings - Diagnostics.....	52
<b>5.4 Layout Screen.....</b>	<b>53</b>
5.4.1 Arranging Items on the Bed.....	54
<b>5.5 Settings Screen .....</b>	<b>56</b>
5.5.1 Starting Production .....	56
5.5.2 Filament Settings.....	57
5.5.3 Print Settings .....	58
5.5.4 Advanced Settings - Material.....	60
5.5.5 Advanced Settings - Print Profile.....	63
5.5.6 Advanced Settings - Extrusion .....	64
5.5.7 Advanced Settings - Nozzles .....	67
5.5.8 Advanced Settings - Support .....	70
5.5.9 Advanced Settings - Speed.....	72
5.5.10 Advanced Settings - Cooling.....	75
<b>6.0 Finishing Parts.....</b>	<b>78</b>
6.1 Removing Breakaway Support Material.....	79
6.2 Removing Soluble Support Material.....	80
6.2.1 Polyvinyl Alcohol (PVOH).....	80
6.2.2 High Impact Polystyrene (HIPS) .....	80
6.2.3 Polylactic Acid (PLA) .....	80
6.3 Vapour Finishing .....	81
<b>7.0 Calibration and Maintenance .....</b>	<b>82</b>
7.1 Calibration .....	83
7.1.1 Nozzle Opening.....	83
7.1.2 Nozzle Height.....	86
7.1.3 X and Y Offset.....	88
7.2 Maintenance .....	91
7.2.1 Purge Nozzles .....	91
7.2.2 Eject Stuck Material .....	92
7.2.3 Speed Test.....	92

7.2.4 Cleaning .....	92
7.2.5 Print Bed .....	92
7.2.6 Build Chamber .....	93
7.2.7 Extruder .....	93
7.2.8 Lubrication .....	94
7.3 Troubleshooting.....	95
<b>8.0 Supplementary Information .....</b>	<b>100</b>
8.1 GCode Commands.....	101
8.2 Frequently Asked Questions .....	105
8.2.1 Hardware .....	105
8.2.2 Software .....	107
8.2.3 Printing.....	108
8.3 Glossary of Terms.....	109
8.4 Contact Us .....	121

1.0

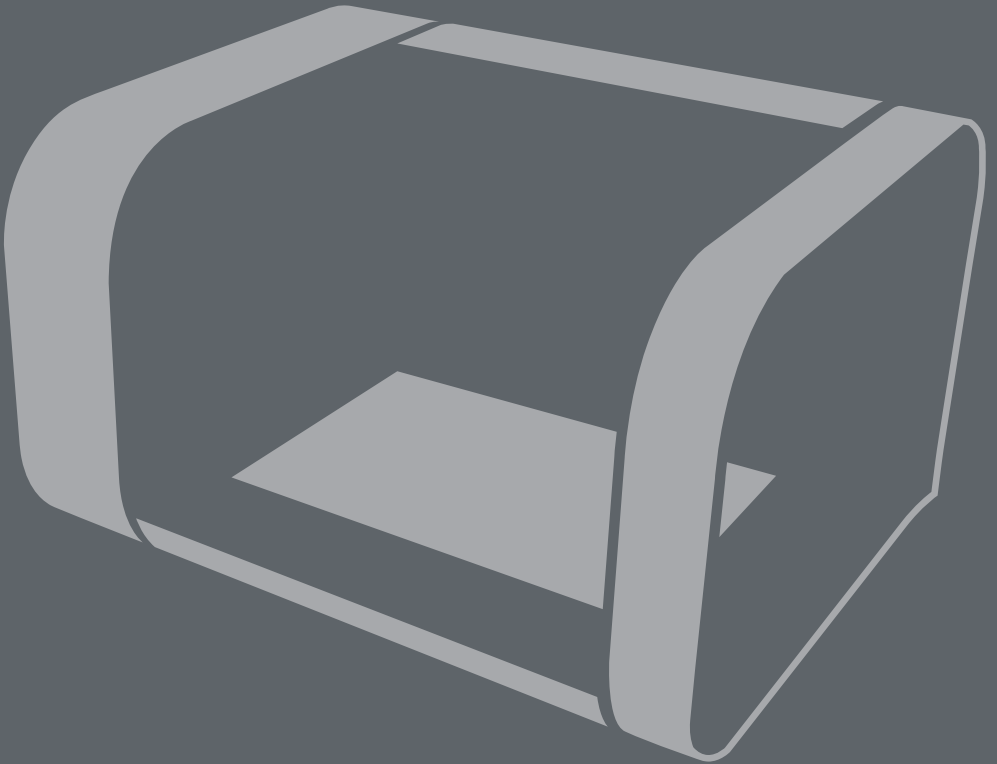

Introduction

## 1.1 Welcome

Thank you for purchasing the Robox® micro-manufacturing platform and welcome to the future of custom manufacturing!

Robox® provides you with the capability to produce three-dimensional models in a variety of thermoplastic materials and with our HeadLock™ easy replacement system, you can begin to explore a whole range of personal manufacturing possibilities.

## 1.2 Learn More

Refer to the following sources for additional information and for product and software updates.

- [Quick Start Guide](#)  
You will find this in the product packaging along with the warranty registration card and safety information booklet. It contains a brief setup guide for Robox® to get you printing as easily as possible.
- [Safety Information Guide](#)  
You will also find this in the product packaging - it contains essential information relating to safety and certification. Please read carefully before using Robox®.
- [Official Robox® website - www.cel-robox.com](http://www.cel-robox.com)  
The Robox® website provides up to date information on available hardware and software products compatible with the system. It also contains contact details, warranty information and support.
- [Optional Documentation](#)  
Your product packaging may include optional documentation, such as warranty flyers, that may have been added by your dealer. These documents are not necessarily part of the standard package.

## 1.3 Using This Guide

This user guide contains the information you need to setup and use your Robox® micro-manufacturing platform.

### 1.3.1 How This Guide Is Organised

This guide contains the following parts:

- **Section 1 - Welcome**  
This section outlines all the important safety considerations, international certifications and information on this user guide and accompanying documentation.
- **Section 2 - Overview**  
This section describes the features and specifications of the product, along with a brief introduction of the printing process and overview diagrams of the major hardware features.
- **Section 3 - Getting Started**  
This section explains how to begin producing items with your new micro-manufacturing platform. It includes how to unpack your new product, software installation and connectivity.
- **Section 4 - Using Robox®**  
This section describes in detail how to use Robox® to produce items, including loading and unloading filament, replacing the print head and removing / replacing the print bed.
- **Section 5 - AutoMaker™ Software**  
This section explains how to use the included AutoMaker™ software to set up your production run. It includes detailed information on printer settings and advanced options.
- **Section 6 - Finishing Parts**  
This section explains how you can improve the quality of your parts after production.
- **Section 7 - Troubleshooting and Maintenance**  
This section includes essential maintenance procedures to keep your Robox® running smoothly, along with a troubleshooting guide to help you to fine tune and diagnose any problems.



- **Section 8 - Supplementary Information**

This final section contains a variety of extra information for your reference. It includes a GCode reference, glossary of terms, FAQs and contact details.

## 1.4 Instructional Icons

The following classifications are used throughout this guide:



- **DANGER/WARNING:** Important information to prevent injury or damage to yourself, people or property when trying to complete a task.



- **CAUTION:** Information to prevent damage to product components when trying to complete a task.



- **IMPORTANT:** Instructions that you must follow to complete a task.



- **NOTE:** Tips and additional information to help you complete a task.



- **GLASSES:** Wear safety glasses to avoid injury to your eyes.



- **GLOVES:** When performing certain procedures, the machine may be hot and gloves are required to avoid burns.

## 1.5 Typography

### **Bold text**

Indicates a menu or item to select.

### *Italics*

Used to emphasise a word or phrase.

### <Key>

Keys enclosed in the less-than and greater-than sign means that you must press the enclosed key.



Example: <Enter> means that you must press the Enter or Return key.

### <Key1>+<Key2>

If you must press two or more keys simultaneously, the key names are linked with a plus sign (+).

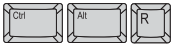

Example: <Ctrl>+<Alt>+<R>



Indicates a mouse button click (left, wheel, right).

## 1.6 Important Safety Information

The following precautions should be made to ensure the safety of yourself and your environment and to protect the product from damage. Please follow these precautions at all times:

### Electrical Safety

- To prevent electrical shock hazard, disconnect the power cable from the electrical outlet before relocating the system or performing any maintenance.
- Seek professional assistance before using an adapter or extension cord. These devices could interrupt the grounding circuit.
- Use the power supply voltage specified on the rating label. Avoid overloading an electrical outlet with multiple devices.
- Use only the power cable supplied with the product. Do not damage, cut or repair the power cable. A damaged power cable carries a risk of fire and electric shock. Replace a damaged power cable with a manufacturer approved power cable.
- Please do not disassemble the product, there are no user serviceable parts inside. If you experience any problems, please contact your local Service Representative or CEL Technology. See the 'Contact Us' section of the User Guide / Warranty Card.
- Ensure the product is well-grounded. Failure to ground the product may result in electrical shock, fire and susceptibility to electromagnetic interference.

## Operation Safety

- Before using the product, ensure all cables are correctly connected to a power supply that matches the rating label and the power cables are not damaged. If you detect any damage, contact your retailer immediately.
- Do not place the product in any area where it may become wet or damp and avoid dusty, humid and high temperature environments which could negatively affect product performance. The printer is designed to work properly at an ambient temperature of between 15°C and 25°C and humidity of between 20% and 50%; Operating outside these limits may result in low quality models.
- Place the product on a stable surface away from flammable substances.
- Do not allow metal or liquids to touch the internal parts of the product. Doing so may cause damage, fire, electric shock or other serious hazards.
- Always use the product in a well-ventilated area.
- Do not use ABS plastic or its printed parts near any kind of heat source - flames, fireworks, candles, incense, light bulbs etc. ABS will catch fire and burn a thick black toxic smoke.
- Power off the product and disconnect the power cable from the power outlet in any of the following cases:
  - If there is any smoke coming from the product.
  - If the product is making an unusual noise not heard during normal operation.
  - A piece of metal or a liquid touches the internal parts of the product.
  - During an electrical (thunder/lightning) storm
  - During a power failure
- When the 3D printing head is installed in the product, there are moving parts which can cause injury and heater elements which generate temperatures in the region of 200-300°C. Never reach inside the product while it is in operation, and never touch the print head while it is hot.
- Always allow the product to cool down completely before reaching inside.
- Never try to override the interlock on the door which protects the user from these dangerous temperatures.
- Contact with extruded material from the 3D print head may cause burns. Wait for printed objects to cool before removing them from the build plate.
- Do not leave Robox® unattended during operation.

## Safety Guidelines

- Follow all safety rules in this section and observe all cautions and warnings in this guide (and those from any additions and materials used in conjunction with the product).
- Before using the product, carefully read and understand all the manuals that were included with the package. Check for updated versions on our website.
- Do not modify any safety features or make modifications to Robox®. Doing so is prohibited and may void your warranty and/or affect the safe operation of the product.
- Use of print materials other than Robox® print materials and genuine Robox® components may void warranty.
- Tie back long hair and loose clothing and keep fingers away from moving parts.
- Adult supervision is required; observe children closely and intervene as necessary to prevent potential safety problems and ensure the appropriate use of the product. Ensure small 3D prints are not accessible to young children.
- These 3D prints are potential choking hazards for young children. Protective glasses should always be worn when removing support material, especially PLA.
- Do not use the product to create items which may be in contravention of laws or regulations applicable in your area.
- If you encounter technical problems with the product, contact a qualified service technician, your retailer or CEL Technology.

## 1.7 Safety Symbols and Definitions

The safety symbols are used throughout this guide and on product warning labels:



- **Hot Surface Hazard:** Information to prevent injury to yourself when trying to complete a task.



- **Caution:** Indicates a pinch point hazard that could cause person injury.



- **Caution:** Indicates an area which carries risk of electric shock - disconnect from the power outlet before accessing.



- **Corrosive:** Used on materials which may be corrosive and cause harm to skin and/or eyes. Wear protective eyewear and gloves.

## 1.8 Legal Notice

The only warranties for CEL Technology products and services are set forth in the express warranty statement accompanying such products and services. Nothing herein should be construed as constituting an additional warranty. CEL Technology shall not be liable for technical or editorial errors or omissions contained herein.

## 1.9 Copyright

**© 2014 CEL Technology Ltd. All rights reserved.**

*Robox* is a registered trademark of CEL Technology Ltd. *HeadLock* and *AutoMaker* are trademarks of CEL Technology. All other trademarks are the property of their respective owners, and CEL Technology assumes no responsibility with regard to the selection, performance, or use of these non-CEL products. Product specifications are subject to change without notice.

This document is protected by copyright. All rights reserved. Its use, disclosure, and possession are restricted by an agreement with CEL Technology Ltd. per software copyright.

No part of this document may be photocopied, reproduced or translated into another language without the prior written consent of CEL Technology.

*Printed in China.*

*Imprimé en Chine.*

## 1.10 Declaration of Conformity



**Manufacturer:** CEL Technology Ltd.  
Unit 1604, 16/F Nan Fung Commercial Centre,  
19 Lam Lok Street,  
Kowloon Bay,  
Hong Kong

**UK Representative:** C Enterprise (UK) Ltd.  
Unit 3 Harbourmead, Harbour Road,  
Portishead, North Somerset,  
BS20 7AY, United Kingdom

**Type of Equipment:** Personal Manufacturing Robot

**Model Number:** RBX01

We declare under our sole responsibility that the devices mentioned above comply with the following EU Directives:

Electromagnetic Compatibility (EMC)	2004/108/EC
Machinery	206/42/EC
Low Voltage	2006/95/EC

Common Technical Specifications used for demonstration of compliance:	EN55022:2010
	EN60950-1: 2006 + Amendments A11: 2009 + A1: 2010 + A12: 2011
	EN55024:2010
	EN61000-4-2: 2009
	EN61000-4-3: 2006 + Amendments A1: 2008 + A2: 2010
	EN61000-4-4: 2004 + Corrigendum 2008
	EN61000-4-5: 2006
	EN61000-4-6: 2009
EN61000-4-8: 2010	
EN61000-4-11 Second Edition: 2004	

**Date of Validity:** 1<sup>st</sup> August 2014

<b>Design and Technical Construction File Maintained At:</b>	<b>CEL Technology Ltd.</b>	<b>C Enterprise (UK) Ltd.</b>
	Unit 1604, 16/F Nan Fung 19 Lam Lok Street, Kowloon Bay, Hong Kong	Unit 3 Harbourmead, Harbour Road, Portishead, North Somerset United Kingdom BS20 7AY

<b>Name of Authorised Signatory :</b>	Kenneth Tam	Christopher Elsworthy
---------------------------------------	-------------	-----------------------

<b>Position Held in Company:</b>	Chief Operating Officer	Chief Executive Officer
----------------------------------	-------------------------	-------------------------

**Signatures:**

## 1.11 Limited Warranty Statement

CEL Technology Ltd. ("CEL") warrants its' systems and associated peripheral devices and replacement parts (collectively, the "Product") purchased from CEL or an Authorised CEL Reseller to be free from defects in material and workmanship according to the terms and conditions stated below:

Warranties extend only to the original purchaser of the Product. Unless otherwise specified, the warranty on the original Product, as delivered, extends for two years starting on the date of delivery. Authorised distributors and/or resellers have the rights to adjust and/or finalize the properties of the warranty, including but not limited to the duration of the warranty, subject to local regulations. Your sole remedy as purchaser under this Limited Warranty shall be repair or replacement as provided herein.

To preserve your warranty rights, Products must be installed in accordance with the then-current User Guide available at [www.cel-robox.com/downloads](http://www.cel-robox.com/downloads). During the Limited Warranty period, CEL or its' designated representative will, at their option, repair or replace a defective Product as set forth below. Service Parts and replacement Products will be furnished on an exchange basis, and will be either new or refurbished. All replaced parts or replaced Products become the property of CEL, and you will be invoiced for replacement parts if defective parts are not returned as directed by CEL under this Limited Warranty.

This warranty covers all non-consumable parts while used in accordance with official CEL documentation, CEL Robox filaments and with AutoMaker or CEL approved software. CEL has specifically tested and tuned 'Simple Mode' in AutoMaker to ensure reliable, repeatable and safe results using these settings with Robox SmartReels containing official material profiles. 'Advanced Mode' is for users who are experienced with 3D printing and want a higher level of control. The controls available in Advanced Mode can create situations and combinations of settings which can harm Robox components or create dangerous conditions with some materials. Robox is capable of using 3rd party filaments which are not part of CEL test procedures and users are responsible for the safe use of these materials. When Advanced Mode or 3rd party filaments are used, affected components will not be covered by the CEL limited warranty.

CEL will bear the cost of returned parts, provided that you report the warranty claim within the Limited Warranty period and obtain return instructions from CEL prior to return. CEL will not be responsible for any shipping costs or other charges associated with these repairs. These terms only apply if CEL or its' designated representative determines that a fault is present. If no fault is found, the purchaser will bear the cost of all labour, materials and shipping. Replacement parts independently carry a 90-day warranty from date of shipment from CEL or designated representative location. Consumable parts are not covered by this Limited Warranty (these include the printing head, PEI bed sheet, filament, and extruder). Warranty services may be provided by CEL, an Authorised Reseller, or a third party service provider designated by CEL.

No coverage or benefits under this Limited Warranty will exist if any of the following conditions apply:

- (a) The Product has been subjected to abnormal use, improper or inadequate maintenance, unauthorised modifications, unauthorised repair, misuse, abuse, exposure to moisture, flooding, fire, electrical problems associated with incoming power, or other acts which are not the fault of CEL Technology Ltd.
- (b) CEL's Customer Service Department was not notified of the defect or malfunction of the system prior to expiration of the warranty period that was offered.
- (c) Parts or consumables were installed and used that were not certified or approved by CEL.

CEL will also not be liable under any circumstances for Product replacement or associated labour, loss of use, loss of profits, or for any other indirect, incidental, collateral, exemplary, punitive, consequential or special damages, or losses arising out of the purchase of the Product and/or out of this limited warranty, even if CEL or its' designated representative have been advised of the possibility of such damages or claims. To the extent such claims are not excludable as adjudged by a court of competent jurisdiction; you agree to accept as sole and exclusive remedy, a payment equal to the original purchase price for the product adjudged to be defective.



SOME COUNTRIES, REGIONS, STATES OR PROVINCES DO NOT ALLOW THE EXCLUSION OR LIMITATION OF REMEDIES OR OF INCIDENTAL, PUNITIVE, OR CONSEQUENTIAL DAMAGES, OR THE APPLICABLE TIME PERIODS, SO THE ABOVE LIMITATIONS OR EXCLUSIONS MAY NOT APPLY TO YOU. EXCEPT TO THE EXTENT LAWFULLY PERMITTED, THIS LIMITED WARRANTY DOES NOT EXCLUDE, RESTRICT OR MODIFY, AND IS IN ADDITION TO THE STATUTORY RIGHTS APPLICABLE TO THE SALE OF THIS PRODUCT TO YOU.

This warranty gives you specific legal rights and you might also have other rights that vary from country/region to country/region, state to state, or province to province.

EXCEPT FOR THIS LIMITED WARRANTY, AND TO THE FULLEST EXTENT ALLOWED BY LAW, NEITHER CEL NOR ANY AUTHORISED RESELLER MAKES ANY OTHER WARRANTY OF ANY KIND, EXPRESS OR IMPLIED, INCLUDING ANY IMPLIED WARRANTY OF MERCHANTABILITY OR FITNESS FOR A PARTICULAR PURPOSE. CEL TECHNOLOGY DOES NOT OFFER, ASSUME OR AUTHORISE THE OFFER OR ASSUMPTION OF LIABILITY FOR IT OR FOR ANY OTHER WARRANTY, EITHER EXPRESS OR IMPLIED BY ANY AUTHORISED RESELLER OR OTHER INDEPENDENT THIRD PARTY.

## 1.12 Regulatory and Environmental Information

### 1.12.1 Electromagnetic Interference

The normal functionality of the product may be disturbed by Strong Electro Magnetic Interference. If you are experiencing problems, reset the product by cycling the power to resume normal operation. If normal functionality does not resume, please try using the product in a different location.

### 1.12.2 FCC Statements (U.S.A.)

The U.S. Federal Communications Commission (in 47 cfr1 5.105) has specified that the following notices be brought to the attention of users of this product.

This device complies with part 15 of the FCC rules. Operation is subject to the following two conditions: (1) this device may not cause harmful interference, and (2) this device must accept any interference received, including interference that may cause undesired operation.

**Shielded cables:** use of shielded data cables is required to comply with the Class A limits of Part 15 of the FCC Rules.

**Caution:** Pursuant to Part 15.21 of the FCC Rules, any changes or modifications to this equipment not expressly approved by CEL Technology Ltd. may cause harmful interference and void the FCC authorization to operate this equipment.

**Note:** This equipment has been tested and found to comply with the limits for a Class A digital device, pursuant to Part 15 of the FCC Rules. These limits are designed to provide reasonable protection against harmful interference in a commercial environment. This equipment generates, uses and can radiate radio frequency energy and, if not installed and used in accordance with the instructions, may cause harmful interference to radio communications. Operation of this equipment in a residential area is likely to cause harmful interference, in which case the user will be required to correct the interference at their own expense.

## 1.12.3 Canada Electromagnetic Compatibility (EMC)

- Normes de sécurité (Canada)

Le présent appareil numérique n'émet pas de bruits radioélectriques dépassant les limites applicables aux appareils numériques de Classe A prescrites dans le règlement sur le brouillage radioélectrique édicté par le Ministère des Communications du Canada.

- DOC statement (Canada)

This digital apparatus does not exceed the Class A limits for radio noise emissions from digital apparatus set out in the Radio Interference Regulations of the Canadian Department of Communications.

## 1.12.4 MSDS (Material Safety Data Sheets)

You can obtain current Material Safety Data Sheets for the materials used in the product at: [www.cel-robox.com/materials](http://www.cel-robox.com/materials)

## 1.12.5 Disposal of waste equipment by users in private households in the European Union (WEEE)

This symbol on the product or on its packaging indicates that this product must not be disposed of with your other household waste. Instead, it is your responsibility to dispose of your waste equipment by handing it over to a designated collection point for the recycling of waste electrical and electronic equipment. The separate collection and recycling of your waste equipment at the time of disposal will help to conserve natural resources and ensure that it is recycled in a manner that protects human health and the environment. For more information about where you can drop off your waste equipment for recycling, please contact your local city office, your household waste disposal service or the shop where you purchased the product.



2.0

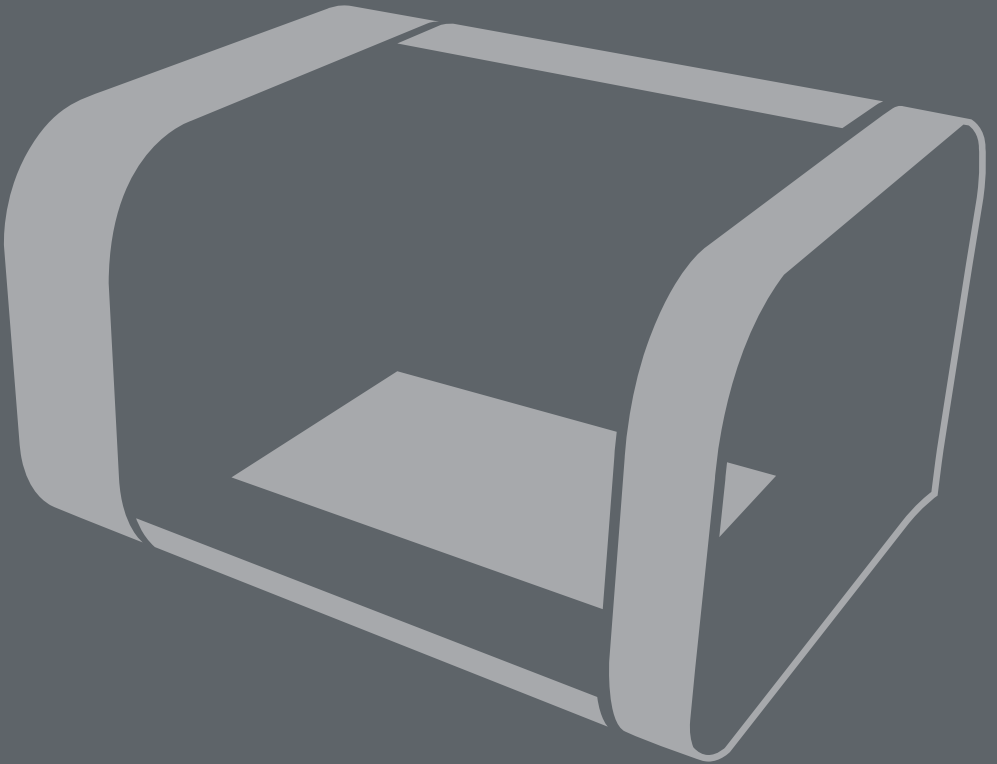

Overview

## 2.1 Features

- QuickFill™ Dual Nozzle Technology
- Auto Z Height Calibration
- ‘TapeLess’ High Performance PEI Bed Material
- HeadLock™ quick change head system
- Single or Dual Extruders
- Automatic Material Recognition (SmartReel™) and Instant Loading
- Automatic Head Recognition
- Draft Blocking Build Chamber
- 2 minute Fast Heat-up Time
- Plug and Play - no set up or assembly required

## 2.2 Specifications

### 2.2.1 Physical Dimensions

- **External Size (LxWxH):** 370 x 340 x 240mm (14.5 x 13.4 x 9.4 in)
- **Desk Footprint (LxW):** 370 x 340mm (14.5 x 13.4 in)
- **Shipping Box (LxWxH):** 495 x 395 x 295mm (19.5 x 15.5 x 11.5 in)
- **Product Weight:** 8 kg (17.6 lbs)
- **Shipping Weight:** 9.8 kg (21.6 lbs)

### 2.2.2 Temperature

- **Operation Temperature:** 15°—25°C (60°—77°F)
- **Storage Temperature:** 0°—40°C (32°—104°F)
- **Max. Bed Temperature:** 150°C (302°F)
- **Max. Nozzle Temperature:** 300°C (572°F)

### 2.2.3 Electrical

- **Power Requirements:** AC 100-250V~, 50/60Hz, 3A max
- **Connectivity:** USB 2.0 and IEC C5 AC Cable
- **microSD Compatibility:** upto 32Gb (SDHC Version 2.0) Any Class

### 2.2.4 Mechanical

- **Build Platform:** Heated Polyetherimide (PEI)
- **XYZ Bearings:** Ball Raced Linear (6mm and 8mm ID)
- **Stepper Motors:** 1.8° Step Angle with 1/16 Micro Stepping

### 2.2.5 3D Printing Head

- **Print Technology:** Fused Filament Fabrication (FFF)
- **Build Size (LxWxH):** 210 x 150 x 100mm (8.3 x 5.9 x 3.9 in)
- **Layer Resolutions:**
  - Super (20 microns / 0.0008 in)
  - High (100 microns / 0.0039 in)
  - Standard (200 microns / 0.0078 in)
  - Low (300 microns / 0.0118 in)
- **Positioning Precision:**
  - XY: 7.5 microns (0.0003 in)
  - Z: 0.15625 microns (0.000006 in)
- **Filament Diameter:** 1.75mm (0.069 in)
- **Nozzle Diameters:** 0.3mm (0.012 in) and 0.8mm (0.031 in)
- **Model Materials:** PLA, ABS, Nylon, PC, PET, PC-ABS + others
- **Support Materials:** PVA, HIPS, PLA

### 2.2.6 Software

- **Software Bundle:** Robox® AutoMaker™
- **File Types:** .stl, .obj, .robox
- **Software Compatibility:** Windows (7, 8), Mac OS x (10.6 x64/10.7+), Ubuntu Linux (12.04+)

## 2.3 Minimum Hardware Requirements

<b>Processor</b>	<b>Minimum:</b>	Dual-core 2.0Ghz
	<b>Recommended:</b>	Quad-core 3.0Ghz
<b>System RAM</b>	<b>Minimum:</b>	2GB
	<b>Recommended:</b>	4GB or greater
<b>Hard Disk</b>	<b>Installation:</b>	256MB
	<b>Minimum:</b>	2GB
	<b>Recommended:</b>	4GB or greater
<b>Graphics Card</b>	<b>Minimum:</b>	1024x768 or greater 128MB or greater memory
	<b>Recommended:</b>	1680x1050 or greater 256MB or greater memory or integrated Intel HD graphics OpenGL v2.0 Support

## 2.4 How It Works

### 2.4.1 3D Printing

When Robox® is using the 3D printer head, it uses a technology known as Fused Filament Fabrication (FFF). This works in a similar way to a hot-melt glue gun - using plastic filament instead of glue sticks.

The feedstock for the print head is 1.75mm thermoplastic filament which is supplied on a reel for installing into the printer. This is then fed to the head via a Bowden tube using the extruder, which contains two contra-rotating feedwheels to grab hold of the filament, and push it along the tube to the head.

When the filament reaches the head, it is extruded out of a hot nozzle, which melts the plastic and can control the diameter of the extrudate by using two different size nozzles. This twin nozzle arrangement allows for highly detailed outer surfaces of the print (those that are visible), alongside the larger nozzle which is used for filling in parts quickly.

The printer head is mounted to a quick-release carriage, known as HeadLock™ which is constrained by a Cartesian axis system, allowing the head to move in 3 dimensions.

The included AutoMaker™ software translates your 3D design files (in .stl or .obj format) into machine coordinates that Robox® can understand. It does this by 'slicing' the 3D model into it's individual layers, and then sending each slice (or layer) to the printer, one at a time.

To produce a part, the molten plastic is laid down one layer at a time, and the head moves up by a small amount (as little as 0.02mm!) at the end of each layer. This allows fully-solid plastic parts to be constructed, with the quality of the surface finish being determined by the height of the individual layers (quality setting).

Robox® SmartReels are available in a variety of materials, finishes and colours and they are automatically recognised by the machine, setting all of the appropriate parameters for you. All you need to do is pick one, choose what quality you'd like your model and hit print!

**Welcome to the exciting world of custom desktop manufacturing!**

## 2.5 At A Glance

This section highlights all the major features of Robox®.

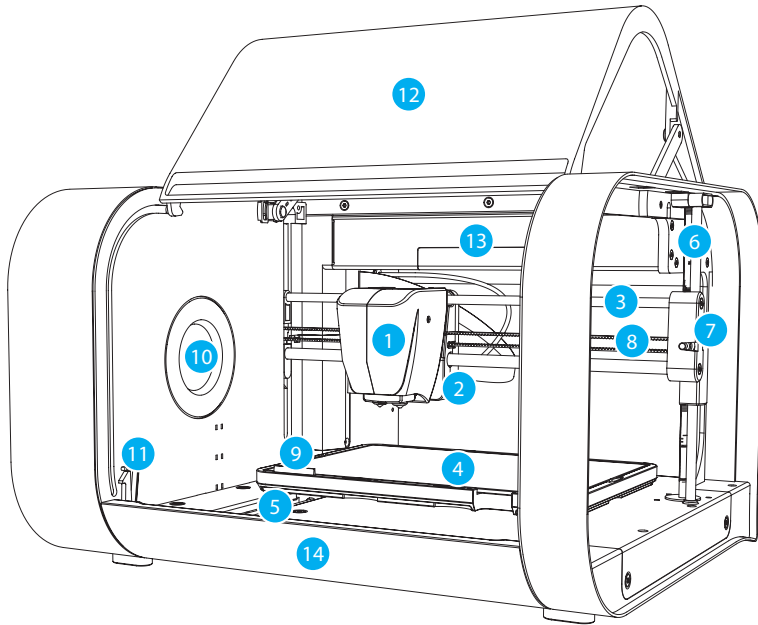

- |                               |                              |
|-------------------------------|------------------------------|
| 1 Print Head                  | 8 X Axis Belt                |
| 2 X Carriage                  | 9 Tip Wipe Blade             |
| 3 X Axis Rails                | 10 Reel Hub Cover            |
| 4 Print Bed                   | 11 Door Interlock Latch      |
| 5 Y Axis Rail                 | 12 Enclosure Door            |
| 6 Z Axis Rail and Drive Screw | 13 Internal Ambient Lighting |
| 7 Z Carriage (Right)          | 14 Front Tray Cover          |

## 2.0 Overview

This view shows the rear connections of Robox® and the SmartReel™ location.

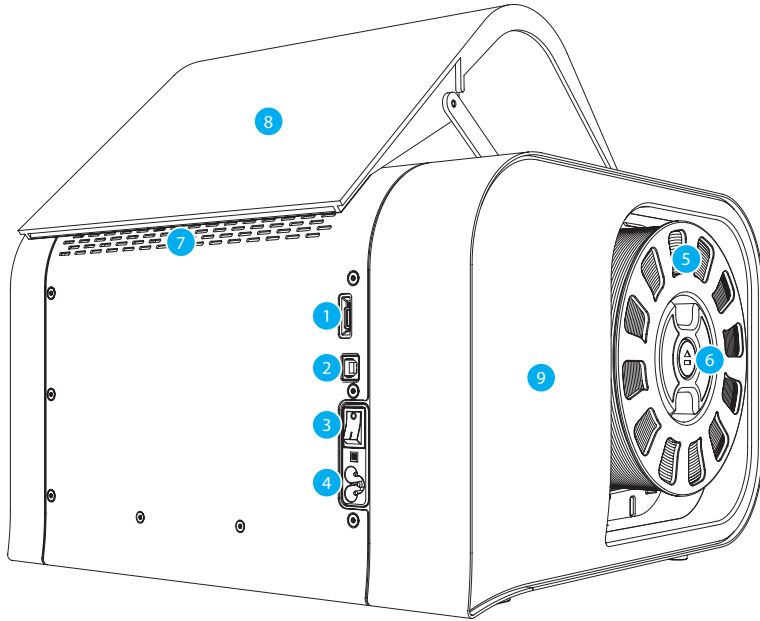

- |   |                             |   |                           |
|---|-----------------------------|---|---------------------------|
| 1 | microSD Card Flash Storage  | 6 | Pause/Resume/Eject Button |
| 2 | USB Type B Socket           | 7 | Outlet Vents              |
| 3 | Power Switch                | 8 | Door                      |
| 4 | C5 'Cloverleaf' Power Inlet | 9 | Side Cover                |
| 5 | Robox® SmartReel™           |   |                           |



- Although there is a microSD card accessible from the back of Robox®, this cannot be read by any other machine and is only for use as internal flash storage - access is provided only for diagnostic/repair purposes.
- Do NOT connect the USB cable until you have completed the installation of AutoMaker™ - see section 3.3.



3.0

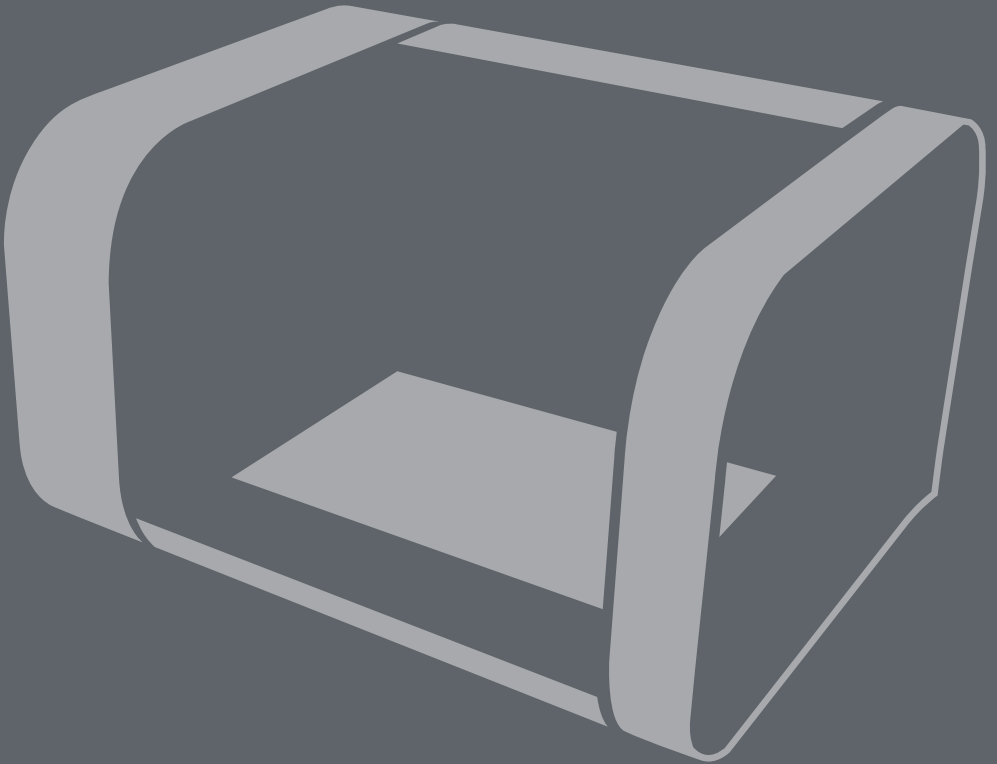

Getting Started

## 3.1 Package Contents

Check your product package for the following items.



2m USB A-B Cable



IEC C5 Power Cable

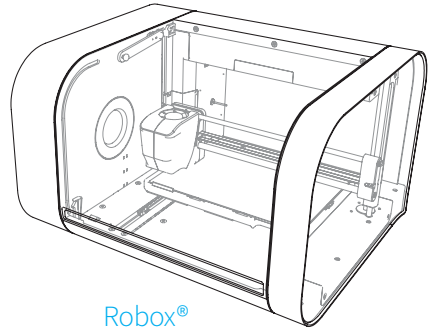

Robox®



USB Flash Drive

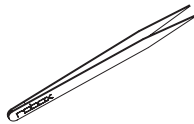

Tweezers



10x Bed Wipes

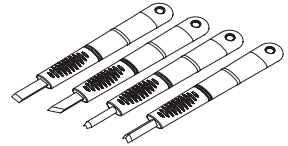

Set of 4 Cleanup Tools



Axis Lubricant



SmartReel™



Safety Guide



Warranty Card



- If any of the above items are damaged or missing, contact your retailer.
- The illustrated items above are for reference only. Actual product specifications may vary with different models.

## 3.2 Unpacking Robox®

This section explains how to safely unpack your new Robox® and get it ready for production! Your new micro manufacturing platform has been carefully assembled and packaged at our factory to arrive with you in perfect condition. Please follow the instructions below carefully to avoid causing any damage.

1. Carefully cut the tape along the top of the box, being careful not to cut too deep, and open the box.
2. Remove the accessories box from the side by pulling on the plastic handle.

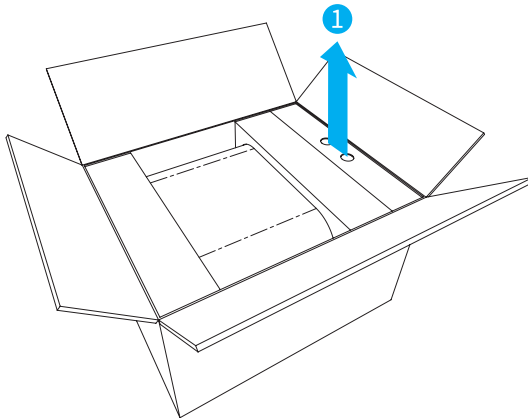

3. Lift Robox® from the box using the two handles in the packing trays on either side.

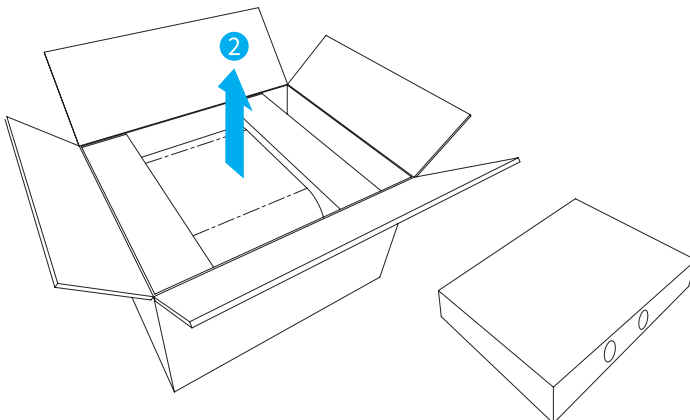

## 3.0 Getting Started

4. Remove the packing tape which is used to secure the door.

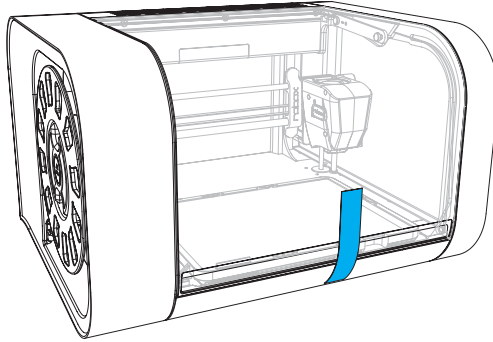

5. Remove the packing tape and warranty card which are secured to the bed and the blue plastic packing clip used to secure the printhead.

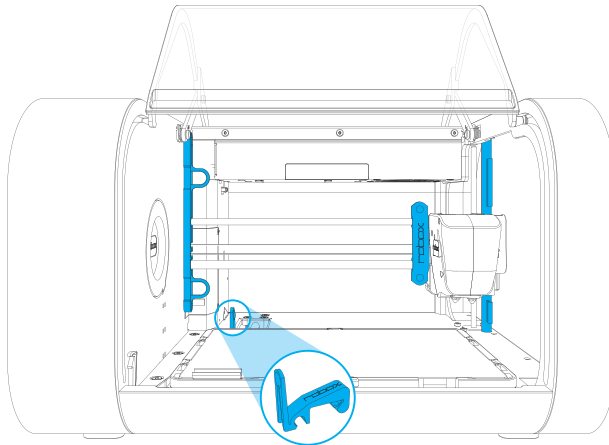

6. Ensure that the head and bed are free to move before proceeding. You can move them both by hand to check.



- We recommend that you keep hold of all of your packaging materials should you need to return any parts to us.

### 3.3 Software Installation

This section explains in detail how to install the AutoMaker™ software package for controlling your Robox®. The included USB card drive contains this software and an electronic version of this document, as well as some sample .stl files for you to print.

These steps may vary slightly depending on your operating system, *all provided screenshots and instructions are from Windows 8 for reference.*

1. Plug your included USB drive into an available USB port (drive letter may vary) - choose **Open folder to view files**:

If this is not displayed, you can access the drive through **My Computer**.

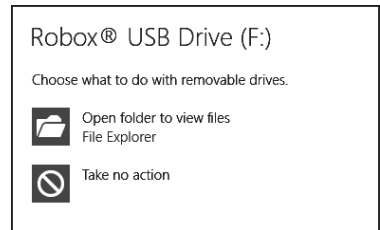

2. The contents of the drive will be displayed in **File Explorer** as shown (view mode may vary).



3. Navigate to **\AutoMaker Software\Windows** and run the installer by double-clicking on the icon - **AutoMaker-windows-installer.exe**



4. Select the installation language from the dropdown menu, and then click **OK** to continue.

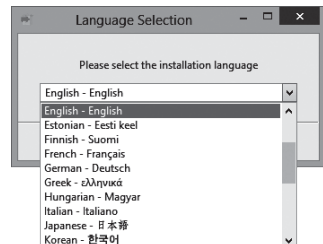

5. The installer will start, click **Next >** to continue.



6. Please carefully read the Licence Agreement and select **'I accept the agreement'**, then select **Next >** to continue.

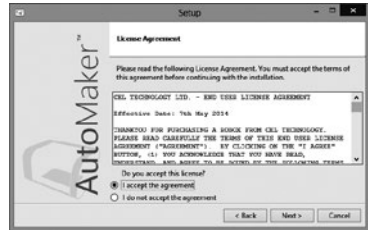

7. Please choose where you would like to install AutoMaker™ either by typing the path directly, or by clicking the  button. Click **Next >** to continue and accept the path and begin the installation. N.B. To facilitate future support we recommend using the default install location.

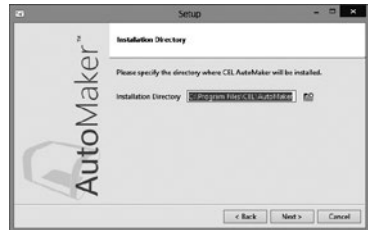

8. Choose whether you would like to add Shortcuts to the Start Menu or Desktop. Then click **Next >** and wait as AutoMaker™ is installed to your hard drive.

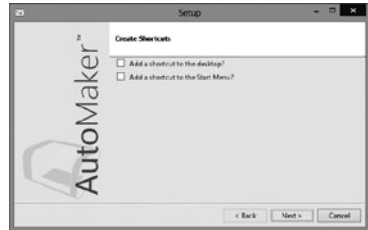

9. Installation is complete. Tick the checkbox if you would like to read the 'Readme' file after clicking **Finish**.

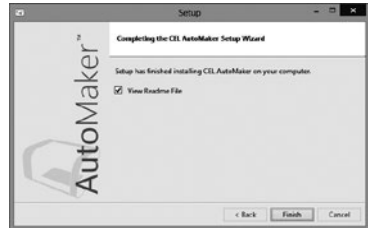

## 3.4 Starting AutoMaker™

This section explains how to start AutoMaker™ on all supported operating systems.

### 3.4.1 On Windows

To start AutoMaker™, double click on the icon shown below on your desktop:

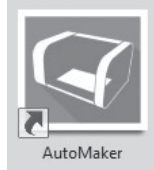

It can also be launched using the Start Menu in the normal way - it can be found under 'CEL'.

### 3.4.2 On MacOS

To start AutoMaker™, click the icon which has been added to your dock. It can also be found under Applications in Finder.

### 3.4.3 On Linux

To start AutoMaker™, open a terminal window and navigate to the installation directory (default is "CEL/AutoMaker") and type `./AutoMaker.run` to start.

## 3.5 Setting Up Your Robox® Account

This section guides you through registering your Robox® and setting up an online account with us. When you start AutoMaker™ for the first time, the product and customer registration screen will be displayed, allowing you to register for product updates, support and warranty repairs.



- AutoMaker™ is continually being improved - please check our website for an updated version of the user manual if you require further information.
- If you have completed the product registration within AutoMaker™, you do NOT need to complete and return the included warranty card.



### 3.6 Attaching the USB Cable

Robox® comes supplied with a 2 metre USB Type A-Type B cable for connecting to your PC. Please connect as shown.

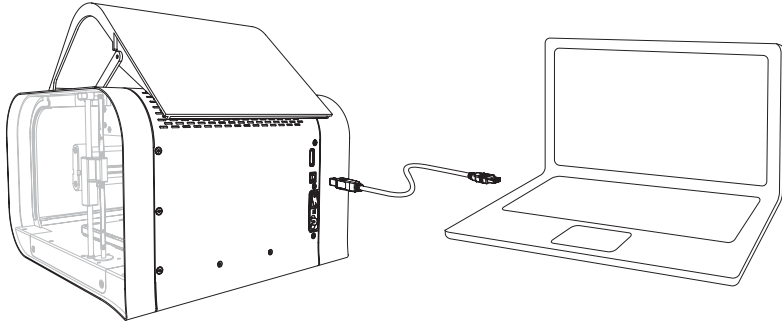

- **DO NOT** connect your Robox® until you have been through the software installation steps on the previous page and started AutoMaker™.

### 3.7 Attaching the Power Cable and Powering On

Connect the supplied AC power lead to Robox® and switch on using the rear power switch.

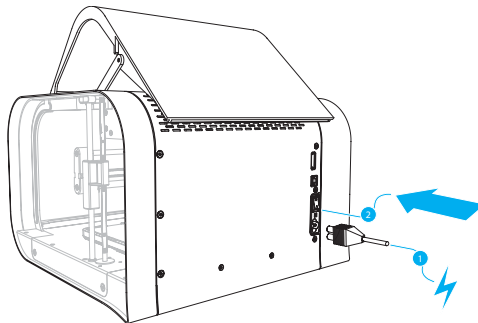

This will install the necessary drivers for connecting your Robox® and could take a few minutes. When correctly installed and switched on, it should appear in Device Manager as a COM port called “Robox v1.0 (COM3)” (COM number may vary). It should also appear on the Status Page of AutoMaker™, along with what reel and head are installed.

4.0

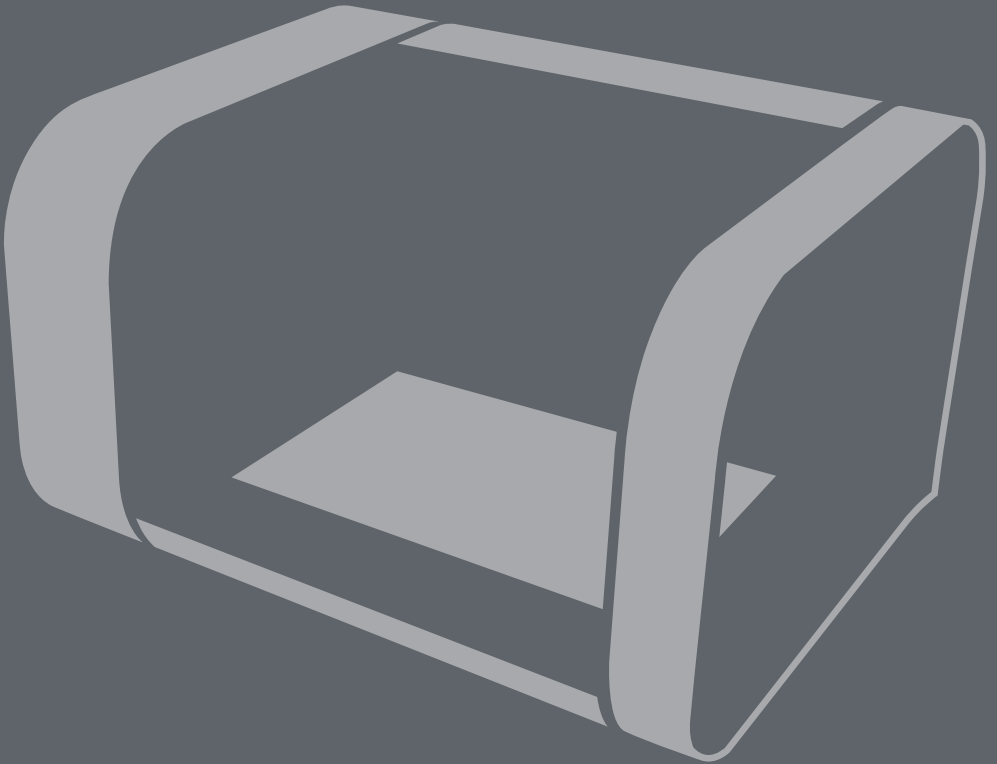

Using Robox<sup>®</sup>

## 4.1 Loading Filament

This section explains how to load your chosen 3D printing plastic filament into Robox® ready to produce your first print! It is designed to be a very simple process with most functions taking place automatically.

### 4.1.1 Preparing the Filament

Before attempting to load filament, it is advisable to cut the end at a shallow angle using a knife or sharp scissors to produce a sharp tip as shown below. This will allow the filament to enter the extruder and melt chamber more easily.

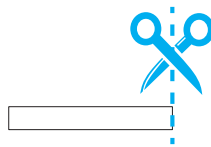

### 4.1.2 Feeding to the Head

Simply feed the end of the filament into one of the two extruder entrances located in the bottom-left of the reel storage dock. If only one extruder is installed in your machine, use the top path marked '1'. It is much easier to perform this operation **BEFORE** installing the reel into the dock.

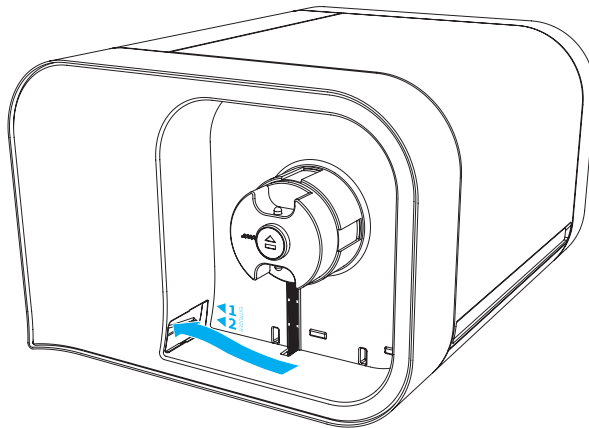

Once the filament reaches the extruder, you will hear the motor start; at this point continue to feed in until you feel the filament has been grabbed. Robox® will then automatically feed the material all the way to the head.

### 4.1.3 Installing the Reel

Finally, install the SmartReel™ into the dock, you should hear a click when it is correctly located, and it should appear as a recognised reel in AutoMaker™. Congratulations! - you're now ready to print.

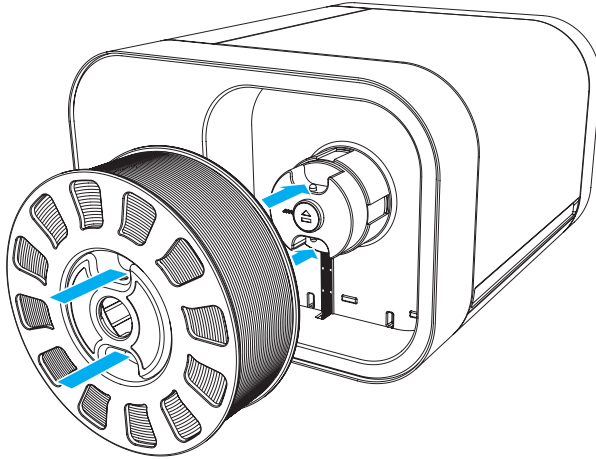

## 4.2 Unloading Filament

This section explains how to remove a reel of filament for storage or to change to a different colour/material. This process has also been designed to be as simple as possible, and can even be undertaken mid-print!

### 4.2.1 Pause / Resume / Eject Button

There is a button in the centre of the reel when installed which has three functions - Pause, Resume and Eject. To pause the print, simply press this button once, and to resume press the button again.

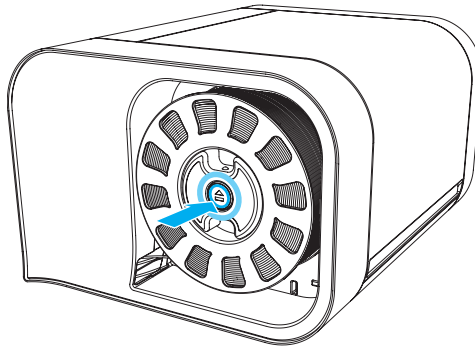

To eject filament, you must hold down this button for 3 seconds, at which point you should hear the extruder motor start and the filament will start to reel back onto the spool.

### 4.2.2 Removing The Reel

Once the extruder motor has stopped, your filament has been fully ejected. Press the two metal buttons on the top and bottom of the reel hub and pull the reel away from the machine. Coil any extra material onto the reel - the loose end can easily be held by weaving in and out of the holes in the rim.

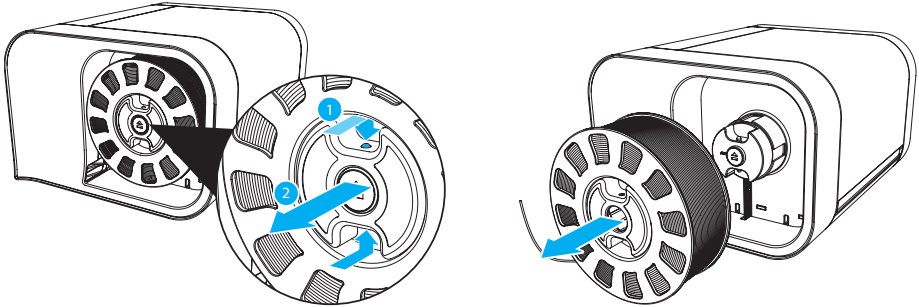

### 4.3 Filament Storage

Most plastics, including ABS and PLA are 'hygroscopic' in nature i.e. they absorb water from the surrounding environment. This often has desirable effects, for example in the case of Nylon, higher water content results in higher part strength.

However, when using plastic filament as a feedstock for 3D printing, higher water content has a negative effect. As the plastic melts in the head, the water content evaporates and turns into steam. As the molten plastic leaves the nozzle, the reduction in pressure creates bubbles in the extrudate. This 'outgassing' of steam can ruin the quality of the print, leaving pock marks in the surface finish where the bubbles have popped.

It is therefore essential to store your filament somewhere very dry when your Robox® is not in use for any extended period of time. SmartReels are packaged in an airtight sealable bag with a sachet of silicagel, which should remove any water from the bag and keep your filament dry. We recommend returning your filament to its bag after each print to ensure it stays print fresh!

If you already have 'wet' filament, it can be dried using an off-the-shelf dessicant or dehumidifier - look out for colour indicating silicagel which changes from orange to green to indicate it has become saturated. It can then be dried in a conventional oven to 'recharge' it - refer to it's accompanying instructions.

## 4.4 The HeadLock™ System

This section explains how to change the head on Robox® allowing you to change its functionality. The base model comes supplied with the Dual Nozzle, Single Material head for FFF 3D printing. All future head designs will make use of the same interface, and the HeadLock™ system has been designed to make head replacement quick and easy. A microchip in each head also allows AutoMaker™ to automatically identify what head is installed, and set itself up appropriately.

### 4.4.1 Removing a Head

To remove the head, click the ‘Head Change’ button in AutoMaker™ and you will see the head move into position to allow easy access to the locking screw.

**Turn off your Robox® using the power switch on the back or at the wall outlet.**

This screw is located behind the head on the back of the X Carriage and is used to firmly constrain and fix the head to the carriage. Reach over the top of the head and rotate this screw counterclockwise to unlock, as shown in the diagram below:



Head Change

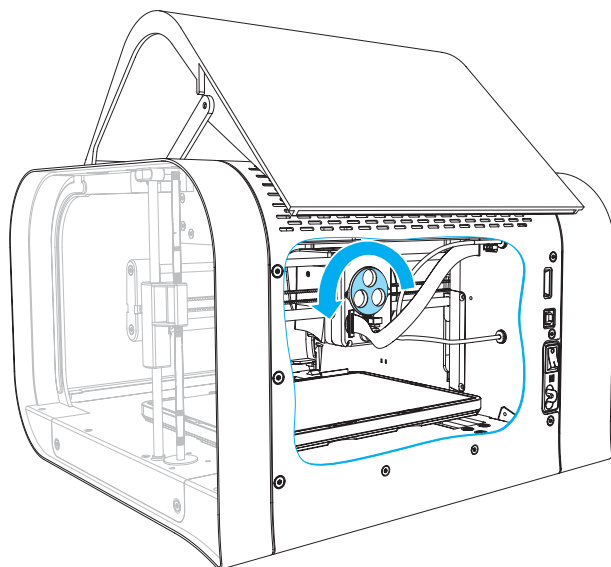

Continue to rotate the locking wheel until you feel it turning freely.

## 4.0 Using Robox

Once unscrewed, pull down the head as shown in the diagram below - you will hear a 'snap' as the head disconnects.

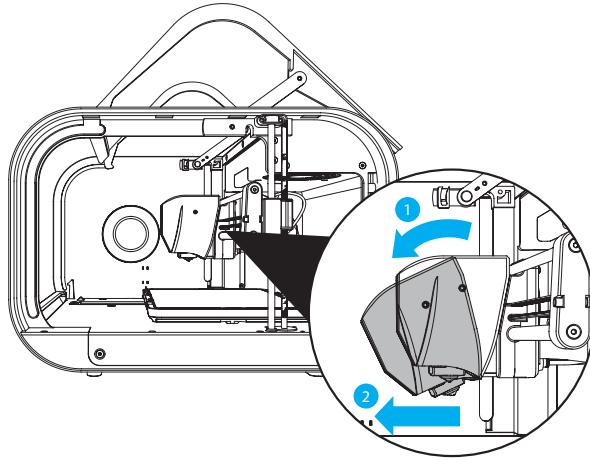

### 4.4.2 Installing a Head

To install a new head into Robox®, the process is essentially the same in reverse. First, push the bottom of the head into the carriage until you hear/feel a 'snap' - this signifies the head is correctly aligned and located, then simply tighten the locking wheel until fully tight. You should see the head recognised in AutoMaker™ when you switch the power back on.

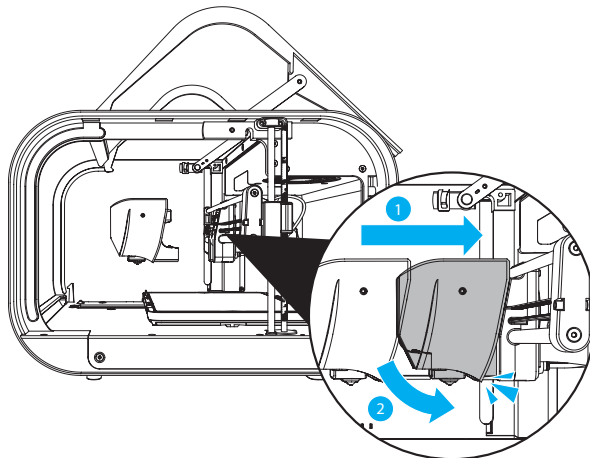



## 4.5 Removing the Bed

To remove the PEI bed from your Robox®, simply slide the handle on the front of the bed (highlighted in blue) to the left to release. Then lift up the front edge of the board using the finger recess (shown by the hand) and slide the bed towards you.

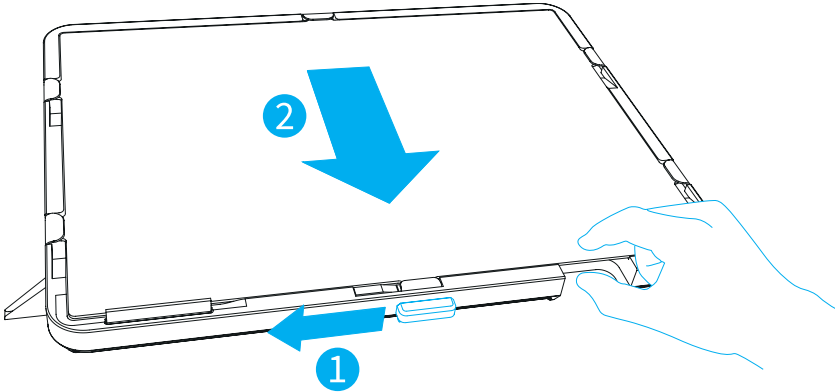

## 4.6 Installing the Bed

To re-install the bed, simply slide the sheet towards the back of the tray, ensuring the tabs are aligned beneath the 4 metal clips on the sides, and then push all the way to the back until it slides under the rear clip and stops. Then simply slide the handle on the front to the right, securing it in position.

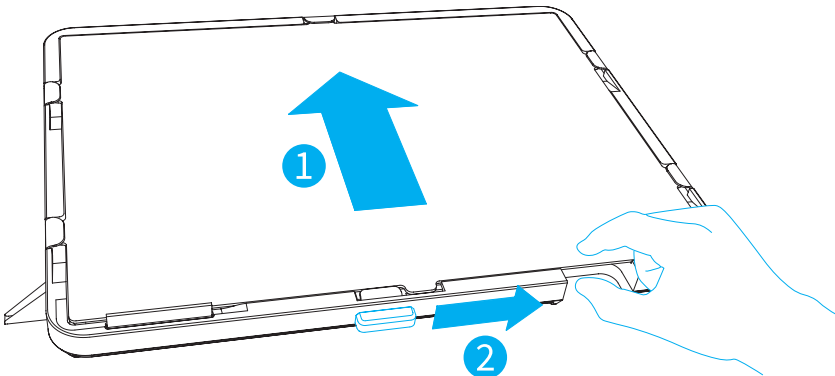

5.0

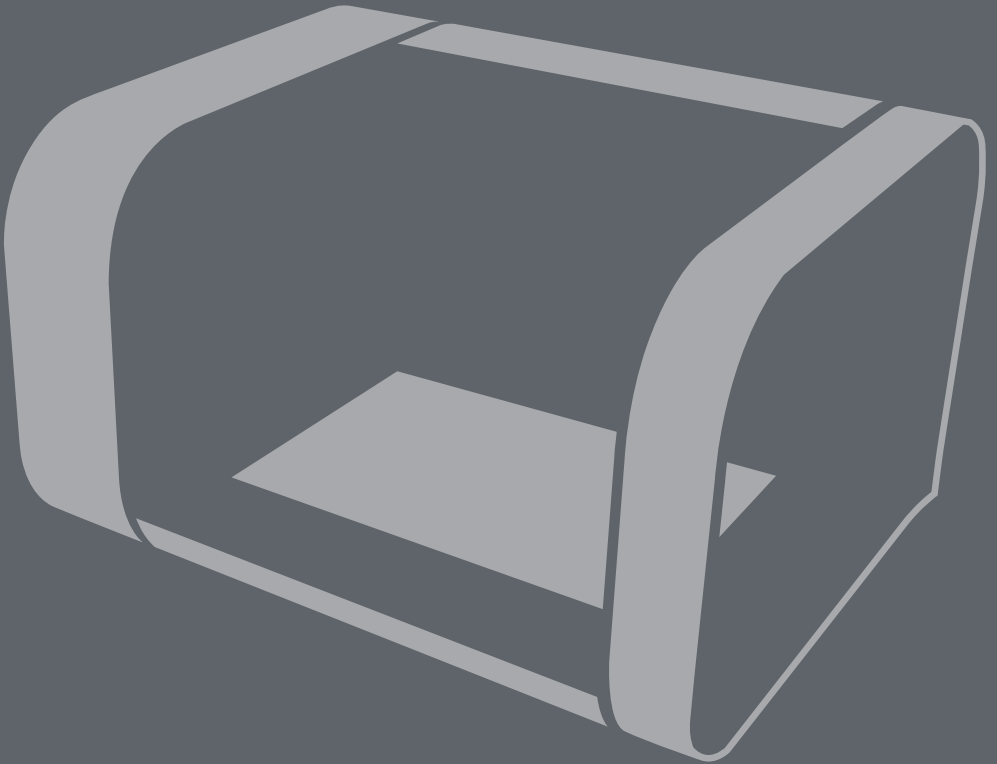

AutoMaker Software

## 5.1 User Interface

This section outlines the major elements which make up the AutoMaker™ user interface. There are basically 3 separate screens - Status, Layout and Settings.

- Status Screen - This page displays the current status of the selected printer. It shows what it's doing, what filament and head are installed, as well as extra information on temperatures etc.
- Layout Screen - This page is used for laying out the 3D models of objects you'd like to print. They can be moved, scaled, duplicated and rotated using simple controls.
- Settings Screen - This page allows you to choose print settings, for example materials, quality/speed, fill density and support.

The software is designed to be as simple to use as possible, so we have removed a lot of the more advanced settings from plain sight, but don't worry there's plenty of room for you tinkerers too!

The diagram below shows the main screen elements of AutoMaker™.

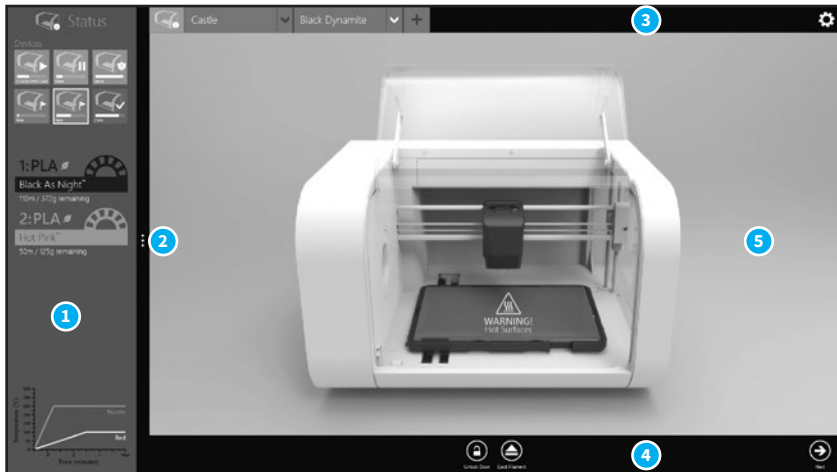

1 Side Bar

2 Advanced Tray

3 Tab Bar

4 Toolbar

5 Program Window

## 5.2 Print Workflow



- AutoMaker™ is continually being improved - please check our website for an updated version of the user manual if you require further information.

## 5.3 Status Screen

This section explains the status screen in more detail.

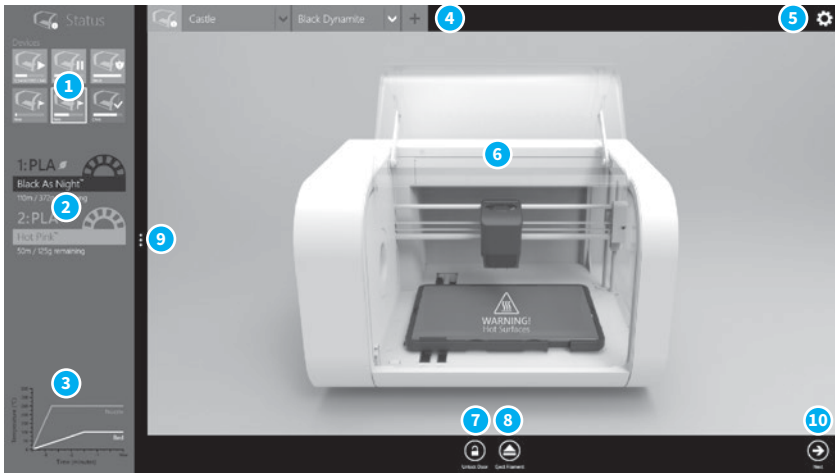





- |                       |                             |
|-----------------------|-----------------------------|
| 1 Connected Printers  | 6 Current Printer Status    |
| 2 Installed Filament  | 7 Unlock Door               |
| 3 Temperature Display | 8 Eject Filament            |
| 4 Projects Tabs       | 9 Display Advanced Settings |
| 5 Preferences         | 10 Go To Settings Screen    |

### 5.3.1 Connected Printers

This area of the screen displays the status of all printers which are currently attached to your PC.



-  Ready
-  Printing
-  Paused
-  Notification
-  Error

Each Robox® connected to AutoMaker™ has its own icon which displays the name and current status of the printer, as well as an indicator which shows the progress of the current print (if available).

The status icons can be summarised as follows:

- Ready - When Robox® is available and ready to print.
- Printing - When Robox® is currently printing an object.
- Paused - When Robox® has been paused during a print.
- Notification - When a message is available in the printer status.
- Error - When Robox® has a problem which must be resolved before continuing.

## 5.3.2 Installed Filament

AutoMaker™ will automatically recognise the material installed on the reel using data stored on a chip inside the reel. Depending on the type of filament on the reel, they are displayed in different ways, as shown below:

**1:PLA**



Chroma Green™

110m / 372g remaining

Robox® SmartReel™

This will be displayed as a reel symbol.

**1:ABS**



Generic/Custom 1

50m / 125g remaining

Generic/Custom Material

This will be displayed as a gear symbol.

**1:ERROR**



Unrecognised Reel

Not Available

Unrecognised/Unformatted Reel

This will be displayed as a crossed circle.



Some of this information is also displayed in the 'Current Printer Status' area of the screen, where the reel is shown installed on the left of the printer.

## 5.3.3 Temperature Display

This area of screen displays a historical graph of the bed, nozzle(s) and ambient temperature over time.

### 5.3.4 Projects Tabs

This part of the screen shows the currently available print jobs. On starting, AutoMaker™ will create an empty project and load any projects which weren't closed on the previous run. Other functions are summarised below:

-  - Creates a new project file
  -  - Displays the context menu explained below
- |        |   |
|--------|---|
| Rename | - Change the name of the project                      |
| Export | - Export the selected project as a .robbox file       |
| Email  | - Email the selected project                          |
| Upload | - Upload the selected project to your Robox® Account. |

### 5.3.5 Current Printer Status

This part of the display provides an overview of the selected Robox®. It shows you what filament, bed and head is installed and also displays warning and status messages.

For example when installing a new filament reel, you will see the reel appear on the status screen. As the bed and head are heating up, you will see a warning message appear once the temperature exceeds 60°C (140°F):



**WARNING!**  
Hot Surfaces

## 5.3.6 Advanced Settings

This part of the screen allows you to perform more advanced functions relating to the overall printer - print job settings are accessed from the Settings Screen - see section 5.5. Its functions are summarised below:

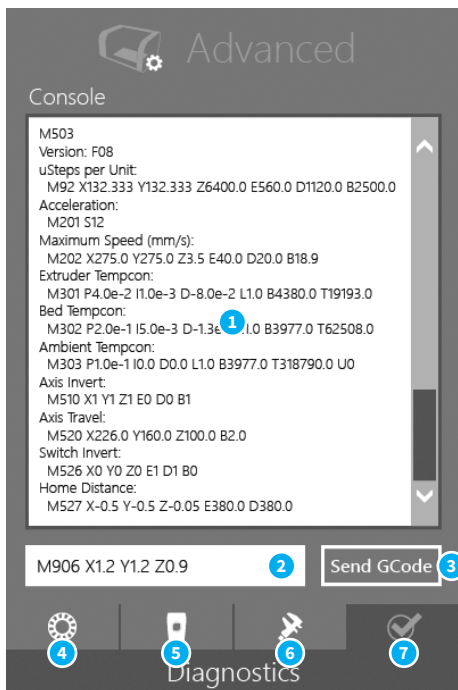

- 1 GCode Console Output
- 2 GCode Text Entry
- 3 Send GCode to Robox®
- 4 SmartReel™ Programming
- 5 Head Programming
- 6 Calibration and Maintenance
- 7 Diagnostics

- **GCode Console**

This console allows you to manually send GCode commands to Robox® over the USB cable. Simply type the command in the text entry box (2) and then click Send GCode (3). A list of all GCode commands applicable to Robox® can be found in the Supplementary Information section at the back of this manual - section 8.1.



### 5.3.7 Advanced Settings - SmartReel™ Programming

This page is for writing custom material parameters to a Robox® SmartReel™. Simply choose which reel to apply the settings to, choose a material from the list - custom or official, then click the Program Reel button.

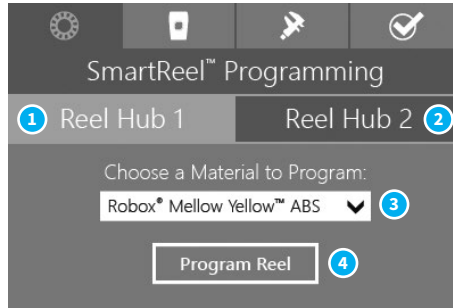

- |                       |                      |
|-----------------------|----------------------|
| 1 Apply to Reel Hub 1 | 3 Material Selection |
| 2 Apply to Reel Hub 2 | 4 Program Reel       |

### 5.3.8 Advanced Settings - Head Programming

This page is for programming the print head with the correct settings based on CEL supplied defaults. Simply click the type of head you have, and click Reset to Defaults. It also displays the unique serial number for your printhead which is useful when contacting CEL support.

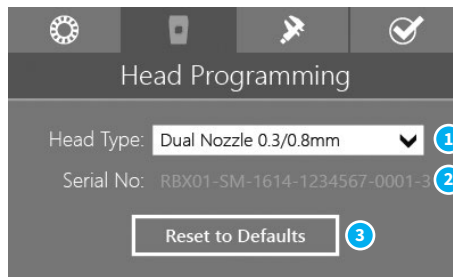

- |                       |                       |
|-----------------------|-----------------------|
| 1 Select Head Type    | 3 Reset Head Defaults |
| 2 Head Serial Display |                       |

## 5.3.9 Advanced Settings - Calibration and Maintenance

This page is for executing a wide range of 'macros' (small GCode programs that execute sequentially) and for access to machine calibration - see section 7.1.

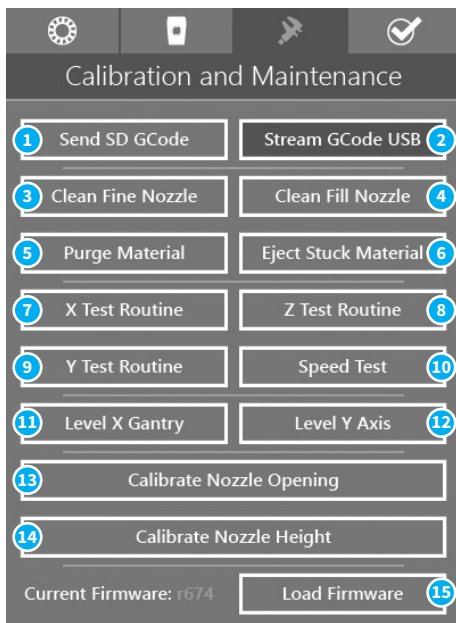

- |                        |                             |
|------------------------|-----------------------------|
| 1 Send SD GCode        | 9 Y Test Routine            |
| 2 Stream GCode USB     | 10 Speed Test               |
| 3 Clean Fine Nozzle    | 11 Level X Gantry           |
| 4 Clean Fill Nozzle    | 12 Level Y Axis             |
| 5 Purge Material       | 13 Calibrate Nozzle Opening |
| 6 Eject Stuck Material | 14 Calibrate Nozzle Height  |
| 7 X Test Routine       | 15 Load Firmware            |
| 8 Z Test Routine       |                             |

- [Send GCode Manually](#)

AutoMaker™ can be used to send GCode manually to Robox® by one of two methods - SD (1) or USB (2) i.e. sending data to the onboard SD flash storage before executing, or transmitting each command one by one over the USB

cable as they are executed.

- [Clean Nozzles](#)

This executes a short GCode ‘macro’ that makes use of the Tip Wipe blade at the front of the bed, and as such should only be executed when the bed is clear of objects. You can choose to clean either the fill or the fine nozzle.

- [Purge Material](#)

This executes the purge routine, which is used when changing between two dissimilar materials - see section 7.2.1.

- [Eject Stuck Material](#)

If you are having difficulty ejecting your filament, this routine may be able to rectify the problem. If you are still unsuccessful, please contact CEL support.

- [Test Routines](#)

These routines are for checking the performance of all the motor axes - X, Y and Z. Speed test gradually ramps up the speed as the test progresses, allowing you to isolate any issues with motion.

- [Level X Gantry](#)

This button executes the automatic bed levelling algorithm. By probing the bed in multiple locations, Robox® is able to determine the level of the bed and independently adjust the Z motors to ensure the X gantry is parallel.

- [Level Y Axis](#)

This is currently an experimental feature which can further improve the quality of bed levelling. Rather than just levelling the gantry, it can continuously adjust the Z height as the bed moves forwards and backwards, ensuring the nozzle is always the same distance from the bed.

- [Calibrate Nozzle Opening](#)

This routine is used to calibrate the point at which the needle valves in the head operate - see section 7.1.1.

- [Calibrate Nozzle Height](#)

This routine is used to calibrate the nozzle lift height - see section 7.1.2.

- [Load Firmware](#)

You shouldn't require this function, unless directed by CEL support - it is used for manually flashing the onboard firmware.

## 5.3.10 Advanced Settings - Diagnostics

This page is really only intended for diagnosing possible faults with your Robox®. It displays the serial numbers of the printer and the head which will be required when contacting CEL support. It also displays the state of all of the microswitches in the printer so that you can verify they are functioning correctly.

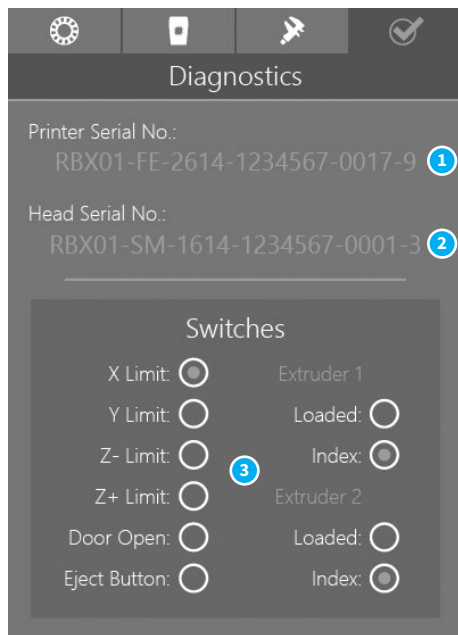

1 Printer Serial Number

3 Switch Diagnostics

2 Head Serial Number

- **Switch Diagnostics**

When any of these switches are triggered on the hardware, they will light up on screen, so you can verify if they are working. There are lights for all limit switches, the door open switch (located in the top left of the build chamber, where it interacts with the door arm), the reel eject button, and the feedback from both extruders. Each extruder has two outputs - 'loaded' is the extruder output switch which detects when filament leaves the extruder, and index is the output from the indexing wheel which measures the passage of filament - you will see it toggle on and off as you move filament back and forth.

## 5.4 Layout Screen

This section explains how to lay out objects on the bed and prepare for printing.

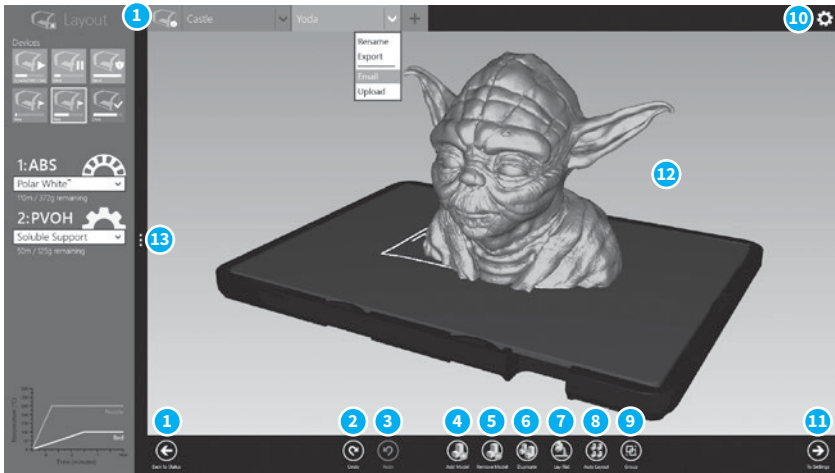







- |                            |                           |
|----------------------------|---------------------------|
| 1 Return to Status Screen  | 8 Auto Layout All Objects |
| 2 Undo Previous Change     | 9 Group/Ungroup Objects   |
| 3 Redo Change              | 10 Preferences            |
| 4 Add New Model            | 11 Go To Settings Screen  |
| 5 Remove Selected Model    | 12 Model Display          |
| 6 Duplicate Selected Model | 13 Advanced Settings      |
| 7 Lay Model Flat           |                           |

- [Preferences](#)

This displays the AutoMaker™ preferences page - see section 5.6.

- [Model Display](#)

This displays a preview of the selected print job, showing the print bed and any objects you have added, arranged as they will be printed. You can rotate the view by clicking the right mouse button and dragging, pan around by holding the <Alt> key and dragging with the right mouse, and zoom by rolling the mouse wheel.

-  Rotate View (click and drag)
-  +  Pan View (click and drag)
-  Zoom (scroll wheel)
-  Select and manipulate models
-  +  Select multiple models

## 5.4.1 Arranging Items on the Bed

This section explains the layout function of the software which allows you to arrange your 3D models on the bed ready for printing. It is designed to be very simple, requiring only the following buttons:



Undo

Step back through the history of layout operations you have completed i.e. undo the last command you executed.



Redo

Step forward through the history of layout operations.



Add Model

This is used to add a new model (.stl/.obj) to the build plate - clicking it reveals a file browser dialog to choose your model from the local filesystem.



Remove Model

This is used to remove the selected model from the build plate.



Duplicate

This is used to duplicate the currently selected item and place it on the build plate.



Lay Flat

This is for reorienting your model to the build plate. Click the button, and then select a surface on the model that you would like to lay flat to the bed.



Auto Layout

This automatically arranges all models on the bed with sufficient clearance between them and no interference.



Group

This used to collect multiple objects together into one selection. When a group is selected, this button will toggle to 'Ungroup'.



- AutoMaker™ is continually being improved - please check our website for an updated version of the user manual if you require further information.

## 5.5 Settings Screen

This section explains the basic settings page of the software which allows you to choose quality options and materials for your print.

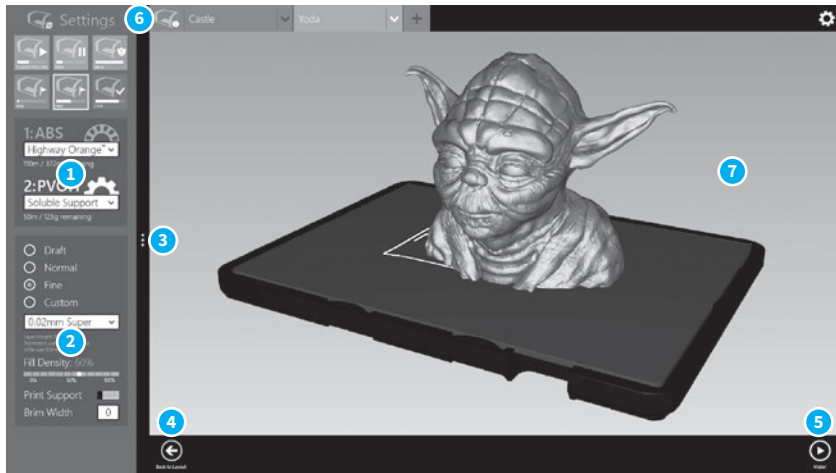

- 1 Filament Settings
- 2 Print Settings
- 3 Advanced Settings
- 4 Return to Layout Screen
- 5 Start the production (Make!)
- 6 Return to Status Screen
- 7 Model Display

### 5.5.1 Starting Production

To start a print, simply choose a quality setting from the Print Settings box (2), verify that your material has been selected in the Filament Settings box (1), and press Make! (5).

AutoMaker™ will then begin to slice your 3D model and transfer to your Robox® ready for printing. Due to the unstable nature of printing 'by wire' - sending data over USB during a print, Robox® incorporates onboard flash storage for storing print jobs once production has started. This means that when the print job has been fully transferred, you can disconnect from the USB, and Robox® will continue to print unattached.



## 5.5.2 Filament Settings

This part of the screen displays what colour and type of filament is currently installed in the machine and allows you to choose and create custom material profiles. It will also show you how much material is remaining on each reel. A brief description of its functions is shown below:

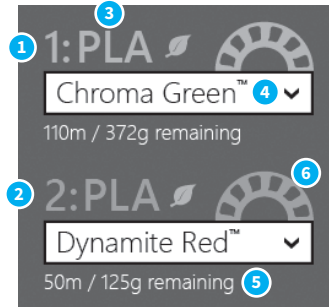

- |                   |                      |
|-------------------|----------------------|
| 1 Extruder 1 Reel | 4 Material Colour    |
| 2 Extruder 2 Reel | 5 Filament Remaining |
| 3 Material Type   | 6 Filament Type      |

- **Material Type**

This displays the material on the reel of filament which is currently installed in Robox® - 1 for the primary reel and 2 for the secondary. A whole range of different materials is available to purchase on SmartReels from [www.cel-robox.com](http://www.cel-robox.com).

- **Material Colour**

This displays the colour of the reel which is installed - click the dropdown menu to define a custom filament - see section 5.5.4.

- **Filament Remaining**

This displays the amount of filament left on the reel in metres and grams.

- **Filament Type**

This icon denotes the type of reel installed in Robox® - SmartReel™, Custom, Unknown or Unrecognised - see section 5.3.2.

## 5.5.3 Print Settings

This allows you to adjust the quality and print profile for production.

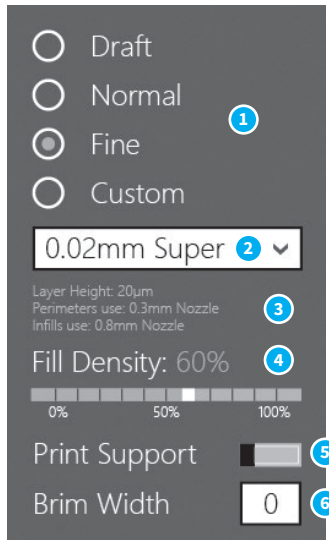

- |                        |                            |
|------------------------|----------------------------|
| 1 Quality Setting      | 4 Fill Density             |
| 2 Custom Print Profile | 5 Support Material Setting |
| 3 Profile Summary      | 6 Brim Width               |

- **Quality Setting**

This allows you to select a basic quality setting from the list of options - Draft, Normal or Fine. The final option - Custom allows you to create a new profile or to select from a previously created one. To create a new profile, click the selection box and choose Create New... - this will expand the Advanced Tray to the right (see section 5.5.5).

- **Profile Summary**

This displays a brief summary of the currently selected print settings. The information available is as follows:

- Layer Height in microns ( $\mu\text{m}$ ).
- Perimeters use - which nozzle is used to print the outside surface of the object.
- Infills use - which nozzle is used to print the inside fill of the object.

- **Fill Density**

This setting allows you to choose how ‘solid’ you would like the finished object to be. The fill pattern can also be changed using a custom profile - see section 5.5.6.

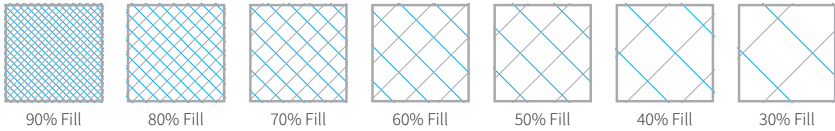

- **Support Material**

This switch toggles the printing of support material. If you are printing a part with large overhangs, you may wish to print structures at the same time to support the object. Support settings (e.g. density and type) can also be changed using a custom profile - see section 5.5.8.

- **Brim Width**

‘Brim’ is a term applied to FFF (Fused Filament Fabrication) which describes a large flat area which is printed around the part to help with bed adhesion and warping. It can be easily trimmed off after printing, but may greatly increase the success rate of prints with a small surface area at the base. This number specifies the number of loops (and therefore the width) of the brim.

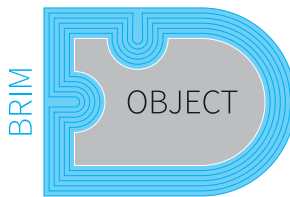

## 5.5.4 Advanced Settings - Material

This section explains the advanced page, and it's associated functions and options.

**Advanced**

**Material** | **Print Profile**

Name: Polar White™ **1**

Type: ABS **2**

Colour: White **3**

Diameter: 1.75 mm **4**

Filament Multiplier: 0.85 **5**

Feed Rate Multiplier: 1.00 **6**

Bed Temperature : 115 °C **7**

Bed Temp. (1st Layer): 125 °C **8**

Nozzle Temperature: 235 °C **9**

Nozzle Temp. (1st Layer): 245 °C **10**

Ambient Temperature: 45 °C **11**

**Bed Temperature**  
This parameter sets the temperature of the print bed during the print i.e. after the first layer. **12**

- |                               |  |
|-------------------------------|--|
| <b>1</b> Material Name        | <b>7</b> Bed Temperature                             |
| <b>2</b> Material Type        | <b>8</b> Bed Temperature (1 <sup>st</sup> Layer)     |
| <b>3</b> Material Colour      | <b>9</b> Nozzle Temperature                          |
| <b>4</b> Filament Diameter    | <b>10</b> Nozzle Temperature (1 <sup>st</sup> Layer) |
| <b>5</b> Filament Multiplier  | <b>11</b> Ambient Temperature                        |
| <b>6</b> Feed Rate Multiplier | <b>12</b> Help Text                                  |

- **Material Name**  
This field can be used to name the material profile - this will be displayed on the Status page when the reel is installed in the dock.
- **Material Type**  
Pick the material type here from the list of available options, or type the name of the material yourself.
- **Material Colour**  
Pick the material colour here, or choose custom to define your own colour.
- **Filament Diameter (mm)**  
Enter the diameter of your filament in mm - it is recommended to use digital calipers / micrometer to obtain an accurate value for this field.
- **Filament Multiplier**  
This value is used to compensate for the 'squishyness' of your material. As filament passes through the extruder, it can be compressed by the feed wheels causing to change shape slightly. This can affect the amount of material that is fed to the head - the harder the material, the closer this value should be to 1.
- **Feed Rate Multiplier**  
This multiplier allows you to finely tune the extrusion rate of the material - it can be adjusted during a print to obtain the optimum extrudate profile. Increasing the value above 1 will cause more material to be extruded and vice versa - 2 would be equivalent to 200% material flow. It varies the amount of plastic proportionally and should be changed in very small steps (e.g. +/- 0.05) as the effects are very visible.
- **Bed Temperature (°C)**  
This value sets the temperature of the print bed surface during a print. A heated bed will help to reduce warping and improve adhesion of a wide range of materials. ABS requires a bed temperature of approximately 110°C for good adhesion, whereas PLA only requires 60-80°C.
- **Bed Temperature (1<sup>st</sup> Layer) (°C)**  
This value sets the temperature of the print bed surface when printing the very first layer of the object. This value is often set higher to ensure good adhesion when starting a print, however the temperature can be lower for the remainder of the print, or it may cause the object to 'sag' at its base.

- **Nozzle Temperature (°C)**  
This value sets the temperature of the nozzle used for printing the material. Different thermoplastics require different nozzle temperatures due to their differing melting points (or more accurately, glass transition temperatures). For example, most ABS requires a nozzle temperature of 240°C, whereas PLA only requires 200°C to print successfully.
- **Nozzle Temperature (1<sup>st</sup> Layer) (°C)**  
This value sets the temperature of the nozzle when printing the very first layer of the object. This value is often set higher to ensure good adhesion when starting a print, however the temperature can be lower for the remainder of the print.
- **Ambient Temperature (°C)**  
This value sets the temperature of the enclosed build area. By maintaining the temperature of the environment, it is possible to keep the printed object warm, reducing its tendency to shrink and warp. The best results will be obtained by maintaining the temperature of the object until the end of the print when the whole object can be cooled simultaneously. Warp is introduced when the part is cooling unevenly, with areas that are shrinking exerting forces on areas that are still warm and soft.
- **Help Text**  
This box displays a brief explanation of the setting which is highlighted (changes on mouseover).

### 5.5.5 Advanced Settings - Print Profile

This section explains the advanced page, and it's associated functions and options:

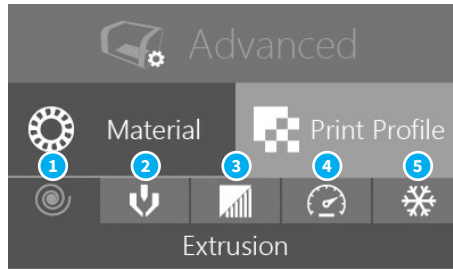

- |   |                             |   |                           |
|---|-----------------------------|---|---------------------------|
| 1 | Advanced Extrusion Settings | 4 | Advanced Speed Settings   |
| 2 | Advanced Nozzle Settings    | 5 | Advanced Cooling Settings |
| 3 | Advanced Support Settings   |   |                           |

- [Advanced Extrusion Settings](#)  
This allows you to adjust advanced printing profile parameters relevant to extrusion e.g. layer height, fill density and fill pattern - see section 5.5.6.
- [Advanced Nozzle Settings](#)  
This allows you to adjust advanced printing profile parameters relevant to both nozzles and needle valve control - see section 5.5.7.
- [Advanced Support Settings](#)  
This allows you to adjust advanced printing profile parameters relevant to automatic support material generation e.g. angle threshold and support pattern and density - see section 5.5.8.
- [Advanced Speed Settings](#)  
This allows you to adjust advanced printing profile parameters relevant to print speed e.g. perimeter speed, infill speed and bridging speed - see section 5.5.9.
- [Advanced Cooling Settings](#)  
This allows you to adjust advanced printing profile parameters relevant to cooling e.g. fan speeds and minimum time per layer - see section 5.5.10.

## 5.5.6 Advanced Settings - Extrusion

These settings allow you to adjust all the parameters which affect the extrusion of plastic and generally relate to print quality and speed. By tuning these values, users can control the appearance, strength and surface finish of objects, as well as dramatically affecting print speed by varying layer height, fill pattern, density and perimeters.

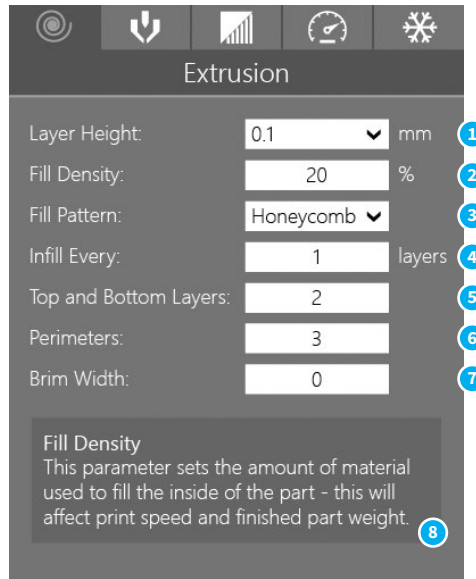





- |                           |                         |
|---------------------------|-------------------------|
| 1 Layer Height            | 5 Top and Bottom Layers |
| 2 Fill Density            | 6 Number of Perimeters  |
| 3 Fill Pattern            | 7 Brim Width            |
| 4 Infill Every ... Layers | 8 Help Text             |



- **Layer Height (mm)**

This setting defines the layer height (essentially the print resolution) of the printed object. Users can select from any value between 20-400 $\mu$ m, however this setting will dramatically affect print time as shown in the below illustration:

Print Representation (1.6mm Total Height)				
Layer Height	400 $\mu$ m	200 $\mu$ m	40 $\mu$ m	20 $\mu$ m
Number of Layers	4	8	40	80
Total Print Time	8 mins	16 mins	1hr 20mins	2hrs 40mins

Also apparent from this diagram is the improved surface finish that will be achieved as layer height is decreased - notice the reduction in the appearance of the 'stair stepping' effect.

- **Fill Density (%)**

This setting changes the amount of material which is used to fill the interior of the object. 100% signifies a completely solid object, and 0% is hollow.

- **Fill Pattern**

This setting is used to change the pattern of the extrusion used to fill the interior of the part. There are 7 different options to choose from:

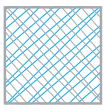

Line

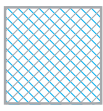

Rectilinear

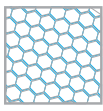

Honeycomb

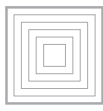

Concentric

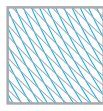
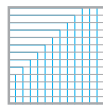
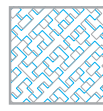
Archimedean  
ChordsOctagram  
Spiral

Hilbert Curve

- **Infill Every  $n$  Layers**

This setting forces Robox® to add a solid infill layer every  $n$  layers. To disable this option, enter 0.

- **Top and Bottom Layers**

This setting specifies how many solid layers will be used to complete the top and bottom of the object. You may need to increase this setting if you are printing an object with a top or bottom surface which tends towards horizontal to avoid gaps in the outer surface.

- [Number of Perimeters](#)

This setting specifies how many outside walls are produced to complete the exterior surface of the part. The more perimeters, the thicker the part walls.

- [Brim Width](#)

This is explained in 'Print Settings' - see section 5.5.3.

- [Help Text](#)

This box displays a brief explanation of the setting which is highlighted (changes on mouseover).

## 5.5.7 Advanced Settings - Nozzles

These settings allow you to adjust all the parameters which affect the operation of the nozzles and needle valves. By tuning these values, users can control the appearance of start/stop points and surface finish, as well as dramatically affecting print speed through the use of the larger fill nozzle.



- |   |                              |    |                         |
|---|------------------------------|----|-------------------------|
| 1 | Perimeter Nozzle Selection   | 7  | Ejection Volume         |
| 2 | Fill Nozzle Selection        | 8  | Wipe Volume             |
| 3 | Support Nozzle Selection     | 9  | Partial Open Value      |
| 4 | Support Interface Nozzle     | 10 | Retract Length          |
| 5 | Fine Nozzle Settings (0.3mm) | 11 | Retract/Unretract Speed |
| 6 | Fill Nozzle Settings (0.8mm) | 12 | Help Text               |

- **Perimeter Nozzle Selection**  
This setting allows you to choose which nozzle is used to print the exterior surfaces (perimeters) of the part - choose from 0.3mm (fine nozzle) or 0.8mm (fill nozzle).
- **Fill Nozzle Selection**  
This setting allows you to choose which nozzle is used to print the internal filling of the part - choose from 0.3mm (fine nozzle) or 0.8mm (fill nozzle).
- **Support Nozzle Selection**  
This setting allows you to choose which nozzle is used to print support material around the part - choose from 0.3mm (fine nozzle) or 0.8mm (fill nozzle).
- **Support Interface Nozzle Selection**  
This setting allows you to choose which nozzle is used to print support interface layers i.e. those between the build and support material - choose from 0.3mm (fine nozzle) or 0.8mm (fill nozzle).
- **Fine Nozzle Settings (0.3mm)**  
This switches the settings below to apply to the fine nozzle (0.3mm).
- **Fill Nozzle Settings (0.8mm)**  
This switches the settings below to apply to the fill nozzle (0.8mm).
- **Ejection Volume (mm<sup>3</sup>)**  
This parameter specifies the volume of material that is ejected as the needle valve closes. The needle itself has a volume, and therefore displaces its equivalent volume of plastic as the valve closes.
- **Wipe Volume (mm<sup>3</sup>)**  
This parameter specifies how much material is left inside the tip of the nozzle once the needle valve has closed. The 'wipe' is used to drag this last bit of material over already printed material to fully drain the nozzle.
- **Partial Open Value**  
This value can be used to specify a smaller needle movement as a ratio i.e. a value of 0.5 will cause the needle valve to only open halfway.

- **Retract Length (mm)**  
This value specifies the distance the filament is 'pulled back' (retracted) at the end of an extrusion path. This is used to release pressure before the needle valve begins to close.
- **Retract/Unretract Speed (mm/s)**  
This value specifies the *speed* that the filament is 'pulled back' (retracted) at the end of an extrusion path and also pushed back in (unretracted) at the start of the next.
- **Help Text**  
This box displays a brief explanation of the setting which is highlighted (changes on mouseover).

## 5.5.8 Advanced Settings - Support

This settings page allows you to adjust all the parameters which affect the automatic generation of support material. Support material is required where objects are being built in mid-air due to an overhang.

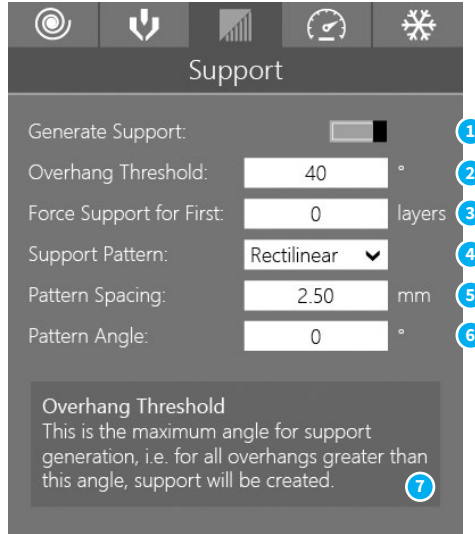

- 1 Generate Support Material
- 2 Overhang Threshold
- 3 Force Support for First ... Layers
- 4 Support Pattern
- 5 Pattern Spacing
- 6 Pattern Angle
- 7 Help Text

- [Generate Support Material](#)  
This turns automatic support material generation on and off.
- [Overhang Threshold \(°\)](#)  
This angle specifies the angular size of an overhang over which support material is generated. Setting this value to '0' tells AutoMaker to determine this value automatically.
- [Force Support for First ... Layers](#)  
This forces AutoMaker™ to generate support material for the first  $n$  layers regardless of the overhang threshold setting.

- **Support Pattern**

This option allows you to set the pattern used to generate the support material - with some options requiring less material, giving faster print times.

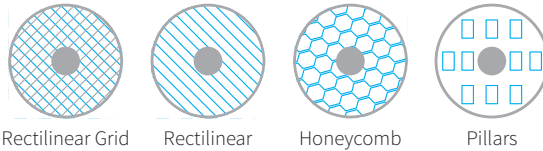

- **Pattern Spacing (mm)**

This specifies the spacing in millimetres between support extrusions i.e. the density of the support material.

- **Pattern Angle (°)**

This option allows the direction of the support lines to be rotated in the XY plane.

- **Help Text**

This box displays a brief explanation of the setting which is highlighted (changes on mouseover).

## 5.5.9 Advanced Settings - Speed

This settings page allows you to adjust all the parameters which affect the speed of printing. There are individual settings for various parts of the print including perimeters, bridges, and infill. By tuning these values, users can control the appearance of printed objects and optimise speed vs. quality.

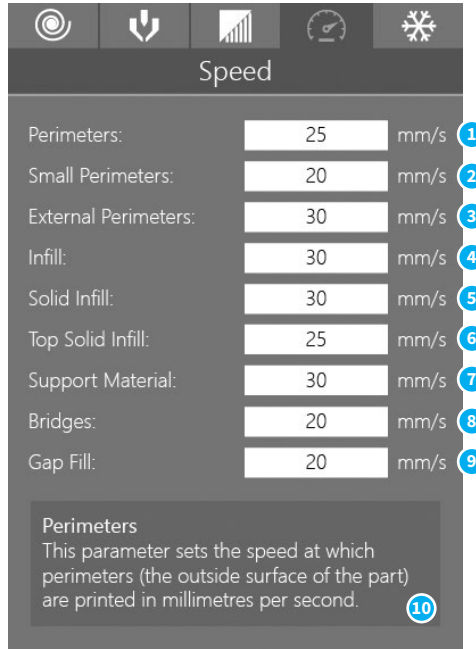

- 1 Perimeter Print Speed
- 2 Small Perimeter Print Speed
- 3 External Perimeter Speed
- 4 Infill Speed
- 5 Solid Infill Speed
- 6 Top Solid Infill Speed
- 7 Support Material Speed
- 8 Bridges Print Speed
- 9 Gap Fill Print Speed
- 10 Help Text



- **Perimeter Print Speed (mm/s)**  
This parameter sets the speed at which perimeters (the walls of the object) are printed in millimetres per second.
- **Small Perimeter Print Speed (mm/s)**  
This parameter sets the speed at which small perimeters (meant for holes, islands and fine details) are printed in millimetres per second. A slower speed than 'Perimeter Print Speed' is recommended for improved quality of small details.
- **External Perimeter Print Speed (mm/s)**  
This parameter sets the speed at which external perimeters (the outside surface of the object) are printed in millimetres per second.
- **Infill Print Speed (mm/s)**  
This parameter sets the speed at which infill (the internal filling of the object) is printed in millimetres per second. This value should be as fast as you can go without compromising the integrity of the fill structure. Faster extrusions can break and result in weak spots of the object.
- **Solid Infill Print Speed (mm/s)**  
This parameter sets the speed at which solid infill (the bottom of the object and any other solid layers) are printed in millimetres per second.
- **Top Solid Infill Speed (mm/s)**  
This parameter sets the speed at which top solid infill (the top surface of the object) is printed in millimetres per second. This is usually slower to allow time for the extrusion to cleanly cover the previous top layers and result in a tidy top surface. The last few layers should have bridged the infill structure nicely, preparing the way for a neat finish.
- **Support Material Print Speed (mm/s)**  
This parameter sets the speed at which support material is printed in millimetres per second. This value should be as fast as you can go without compromising the integrity of the support.

- **Bridges Print Speed (mm/s)**

This parameter sets the speed at which bridges (unsupported layers between two existing surfaces) are printed in millimetres per second. The ability to span unsupported areas depends on the material and cooling. Going too slow will result in sagging, too fast will result in broken strands. Generally bridging runs slower than perimeters.

- **Gap Fill Print Speed (mm/s)**

This parameter sets the speed at which small gaps are printed in millimetres per second. Filling in small gaps results in the head quickly oscillating and the resulting shaking and resonance could have a detrimental affect on the print. A smaller value here can guard against this. A setting of zero disables gap filling completely.

- **Help Text**

This box displays a brief explanation of the setting which is highlighted (changes on mouseover).

### 5.5.10 Advanced Settings - Cooling

This settings page allows you to adjust all the parameters which affect automatic cooling of the part as it prints. Layers must be cooled sufficiently before another layer is applied to prevent dimensional inaccuracy and 'squishy' small layers.

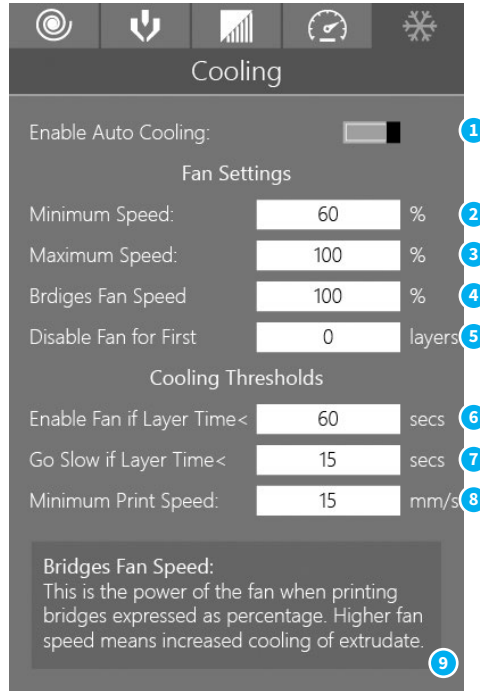

- |                                    |                              |
|------------------------------------|------------------------------|
| 1 Enable Automatic Cooling         | 6 Enable Fan if Layer Time < |
| 2 Minimum Fan Speed (%)            | 7 Go Slow if Layer Time <    |
| 3 Maximum Fan Speed (%)            | 8 Minimum Print Speed        |
| 4 Bridges Fan Speed (%)            | 9 Help Text                  |
| 5 Disable Fan for First ... Layers |                              |

- [Enable Automatic Cooling](#)  
This setting is used to enable or disable automatic cooling for 3D prints. AutoMaker™ uses one of two methods to control cooling - it can either increase the fan speed or slow down the time to print a layer. The choice of which method is used is controlled by 'Enable Fan if Layer Time <' and 'Go Slow if Layer Time <'.  
[Go to: `Enable Fan if Layer Time <`](#)
- [Minimum Fan Speed \(%\)](#)  
This sets the minimum fan head speed as a percentage of full power.  
[Go to: `Minimum Fan Speed \(%\)`](#)
- [Maximum Fan Speed \(%\)](#)  
This sets the maximum fan head speed as a percentage of full power.  
[Go to: `Maximum Fan Speed \(%\)`](#)
- [Bridges Fan Speed \(%\)](#)  
This sets the fan speed which is used when printing bridges as a percentage of full power.  
[Go to: `Bridges Fan Speed \(%\)`](#)
- [Disable Fan for First  \$n\$  Layers](#)  
This disables the head fan when printing the first  $n$  layers, this can help with adhering the first layer to the bed. It is recommended to leave it off for the first 1 or 2 layers.  
[Go to: `Disable Fan for First  \$n\$  Layers`](#)
- [Enable Fan if Layer Time < \(seconds\)](#)  
This will increase the fan speed to maximum if the layer time takes less than the specified value in seconds.  
[Go to: `Enable Fan if Layer Time < \(seconds\)`](#)
- [Go Slow if Layer Time < \(seconds\)](#)  
This will slow down the print speed if the layer time takes less than the specified value in seconds.  
[Go to: `Go Slow if Layer Time < \(seconds\)`](#)
- [Minimum Print Speed \(mm/s\)](#)  
This setting is a lower limit on how slowly a layer can be printed in millimetres per second.  
[Go to: `Minimum Print Speed \(mm/s\)`](#)
- [Help Text](#)  
This box displays a brief explanation of the setting which is highlighted (changes on mouseover).  
[Go to: `Help Text`](#)



6.0

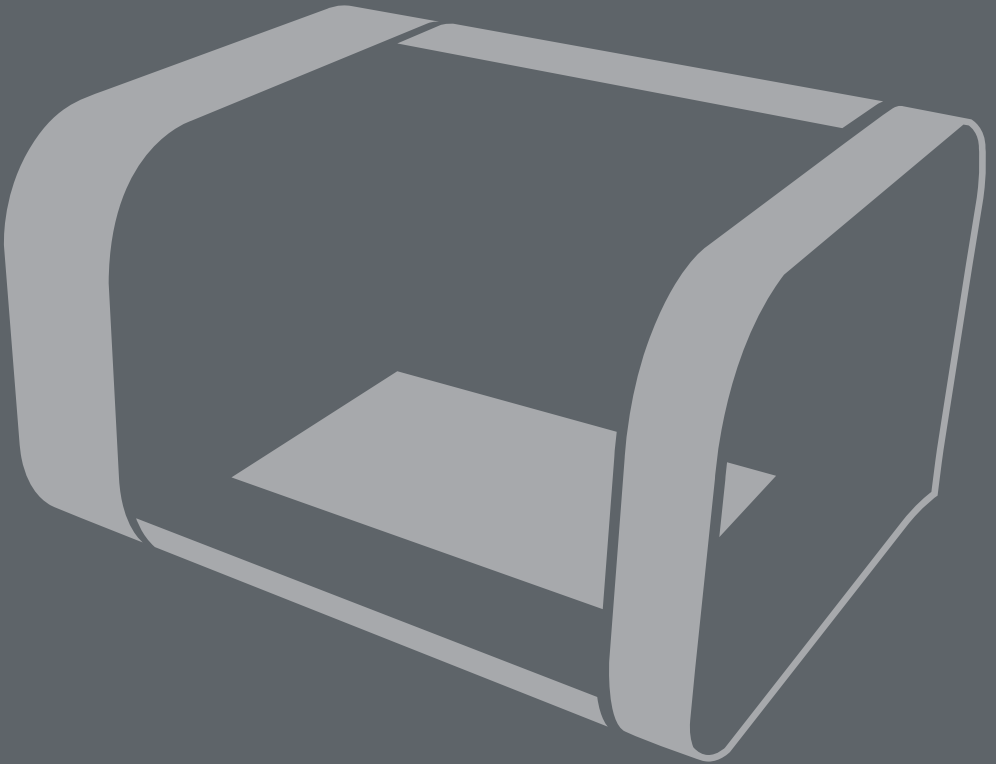

Finishing Parts

## 6.1 Removing Breakaway Support Material

Breakaway Support Material is produced using the same material as the desired part, and therefore Robox® only requires a single material head and one reel installed. A lattice of material is extruded at the same time as the rest of the part which is used to ‘prop up’ the printing of unsupported areas (overhangs, bridges etc.).

Once your object has finished printing, you will need to remove the support material to reveal the finished part. There are many ways to achieve this, but it usually requires a combination of brute force and delicate trimming. To help you, we’ve provided a set of 4 cleanup tools in the accessories box:

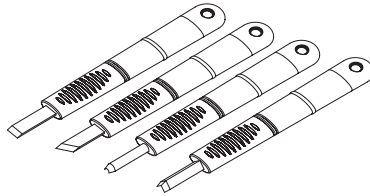

There are a range of shapes which should be very helpful when cleaning up small blemishes on the surface of the part and for cutting away support in difficult to reach areas.

Some material can easily be broken away from the part, or a pair of needle-nose pliers can be useful for crushing/breaking support and then used to pull the material away. It can be quite a frustrating task, but you will soon discover methods that work, and those that don't - once you've found a good one it's great to see a perfect model emerge from a lump of (seemingly) random plastic.



- **WARNING!** The set of cleanup tools are very sharp - please take extreme caution when using them and **always** cut away from your body. Not suitable for use by children except under adult supervision.



- **WEAR GLASSES** Always use safety glasses/goggles when removing support material, especially PLA as the fragments can be very sharp and could damage the eyes.



- **WEAR GLOVES** Always wear gloves when removing support material as the tools and removed material can be very sharp.

## 6.2 Removing Soluble Support Material

If your Robox® has a dual material head and second reel holder (RBX01-DM) then you can make use of Soluble Support Material for supporting your models. Your part is left with no visible blemishes and a smooth surface. The larger areas can be removed by hand to speed up the process, but it is designed to be a largely hands-off process. There are currently 3 possible material choices:

### 6.2.1 Polyvinyl Alcohol (PVOH)

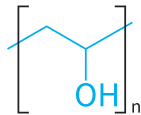

This is a water soluble support material which is compatible with PLA and ABS as a build material. It can be dissolved in cold water, but the process can be accelerated using ultrasonic vibration and/or slightly elevated temperature.

### 6.2.2 High Impact Polystyrene (HIPS)

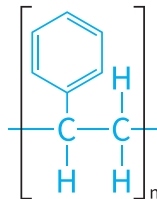

This material is only for use with ABS build material. It can be dissolved in Limonene, which will dissolve the support but leave the ABS intact. The dissolving process can be accelerated using ultrasonic vibration and/or slightly elevated temperature.

### 6.2.3 Polylactic Acid (PLA)

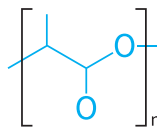

PLA can be used as a support material for ABS parts - it is softened in hot water, allowing for manual removal or it can be dissolved using a hot caustic soda solution and accelerated using ultrasonic vibration.



## 6.3 Vapour Finishing

This is a process which can be used to improve the appearance of the 'stair stepping' effect (visible layers in the print). It works by condensing a thin film of solvent on the surface of the part which partially melts the surface, allowing liquid plastic to flow into the gaps between layers. The solvent used is dependent on the surface to be smoothed, for example Acetone or MEK is used to vapour finish ABS and Ethyl Acetate (sometimes sold as MEK substitute) can be used for PLA/PET.

The solvent is heated to vapourisation temperature in a closed chamber (~60°C for Acetone, ~75°C for Ethyl Acetate), then the part is introduced to this atmosphere. Because the part is cooler than the surrounding vapour, the solvent condenses evenly on the surface.

The amount of smoothing is controlled by the quantity of solvent and the exposure time. If the part is exposed for too long, the surface can melt too much, resulting in a loss of detail as small features begin to melt away.

It is possible to achieve a high gloss finish with no hand finishing using this method. More information can be found online by searching for 'vapour polishing', 'vapour smoothing' or 'vapour finishing'.



- **WARNING!** Use extreme caution when handling solvents - refer to the label. Many can be extremely flammable and can also cause drowsiness, eye and respiratory irritation.

7.0

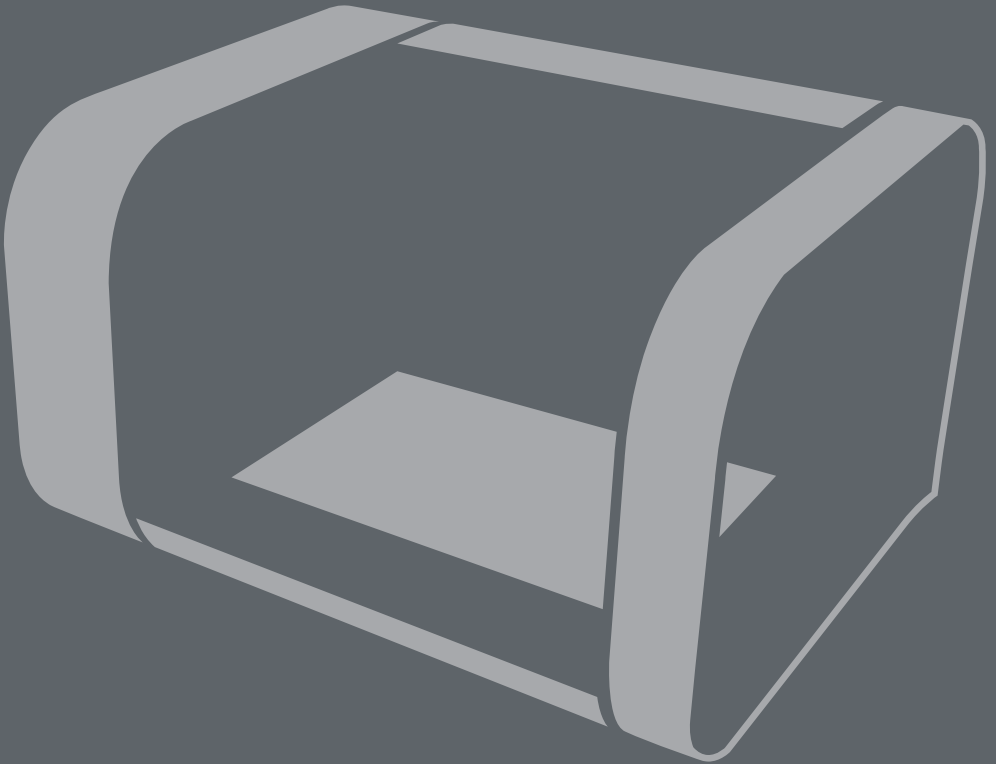

Calibration and  
Maintenance

## 7.1 Calibration

Occasionally Robox® will need to be calibrated to ensure the quality of printed output. This is particularly important on first use or if the unit has been moved or subjected to large shocks or vibration.

The majority of the setup of the machine is performed automatically during the print process, however there are some parameters which vary between machines/heads. These calibrated parameters are stored in the printhead and should only need to be performed once or twice during their lifetime.

All calibration procedures are performed with AutoMaker™, and therefore your Robox® must be connected to your computer with the USB cable. They can be accessed through the Advanced Settings Tray on the Status screen.



- AutoMaker™ is continually being improved - please check our website for an updated version of the user manual if you require further information.

### 7.1.1 Nozzle Opening

This routine is used to calibrate the point at which the needle valves in the head operate. The firmware has to know the point at which the plastic begins to flow in order to accurately control extrusion.

There are a number of things you need to check before starting the calibration sequence:

- You have a Robox® SmartReel™ installed in the material dock
- Extrusion is working correctly, and material can be extruded from both nozzles - if this is not working, please try completing the Purge sequence under Maintenance - see section 7.2.1
- The bed is clear of all obstructions
- The nozzles are clean with no lumps of filament or degraded material
- A pair of tweezers (included in the accessories box) would be useful for removing extruded material during the calibration.

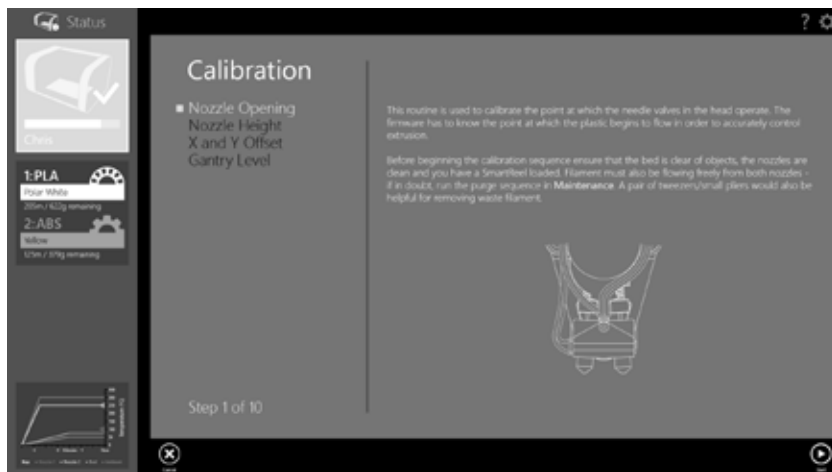

Click **Start** to begin the calibration. AutoMaker™ will begin heating up the nozzles and then fully closing both of the needle valves.



You should NOT see any material being extruded from either nozzle at this stage. If there is anything coming out, then it is likely there is a hardware fault with your head, as it is unable to fully close the valves.

If there is no material being extruded, you will move to the next stage of calibration.



AutoMaker™ will now calculate the ‘opening point’ of the valves for each nozzle in turn. Starting with the nozzles fully closed, you are asked to gradually open the nozzle until the point when material begins to flow. To open the nozzle further, keep clicking ‘Not Flowing’ until material appears, and then click ‘Flowing’. This process is completed first for the fine nozzle and then the fill nozzle.

Ensure both nozzles are clean before proceeding to the next step.



Finally, AutoMaker™ will verify the calibration results by testing extrusion with the nozzles fully closed and fully open.

## 7.1.2 Nozzle Height

This routine is used to calibrate the nozzle lift height. As the print head switches between nozzles, the nozzle which is not printing is lifted up and out of the way of the print. Therefore the software needs to know the difference in height between the two nozzles when they are in their printing position.

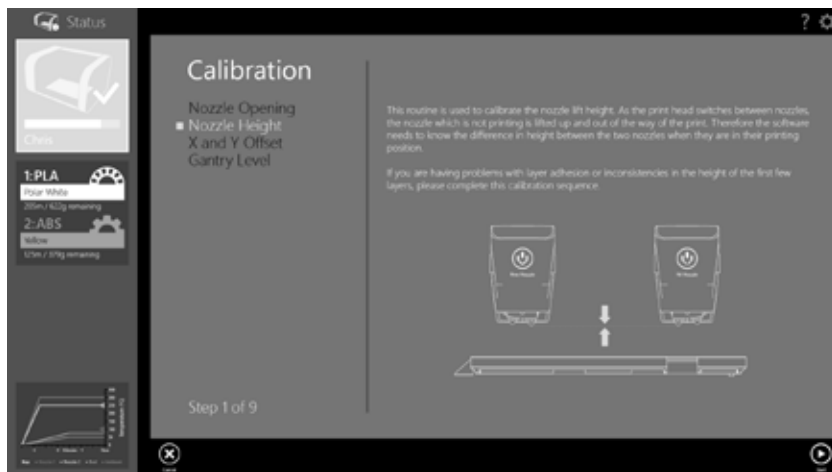

If you are having problems with layer adhesion or inconsistencies in the height of the first few layers, this calibration should rectify the problem. There are a number of things you need to check before starting the calibration sequence:

- First, remove the 'tip wipe' blade in the front left of the bed.
- Next, remove the PEI bed from Robox® by following the on-screen instructions.
- The nozzles are clean with no lumps of filament or degraded material
- You will need a small sheet of paper for measurement (~50x50mm)
- A pair of tweezers (included in the accessories box) would be useful for removing extruded material during the calibration.

When you are ready, click **Start** to begin. AutoMaker™ will first heat the nozzles to prevent any solidified extrudate from affecting the calibration. Next, Robox® will automatically determine the height difference between the two nozzles by probing the aluminium bed a number of times and obtaining an average measurement.

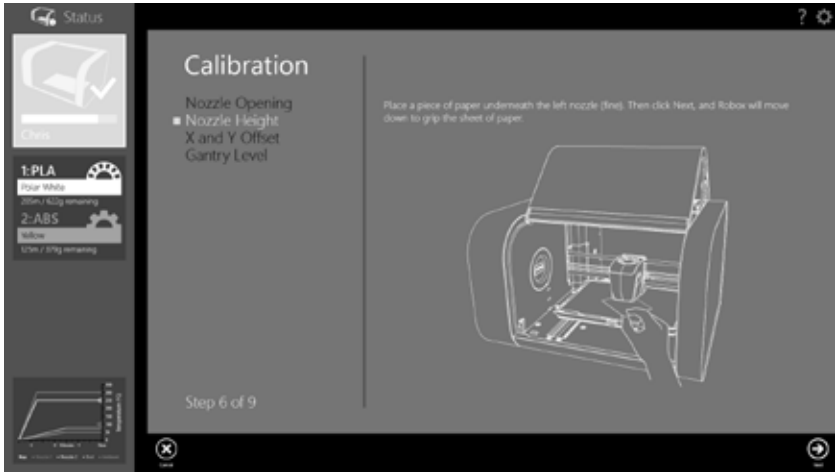

Once this measurement is complete, place the piece of paper under the left-hand nozzle (0.3mm/fine) and click **Next**. Robox® will then move the head down to grip the paper against the aluminium bed.



Using the on-screen arrows you can adjust the height of the head. You are looking to find the lowest position where the paper is able to slide freely beneath the nozzle without touching. Once you are satisfied you have found this point, press the **Next** button to complete the calibration. You can then re-insert the PEI bed and resume printing.

## 7.1.3 X and Y Offset

This routine is used to set the alignment of the two printing nozzles in the X and Y direction. This allows the software to know the location of each nozzle in respect to the other. This operation is similar to the 'print head alignment' found on many desktop 2D printers.

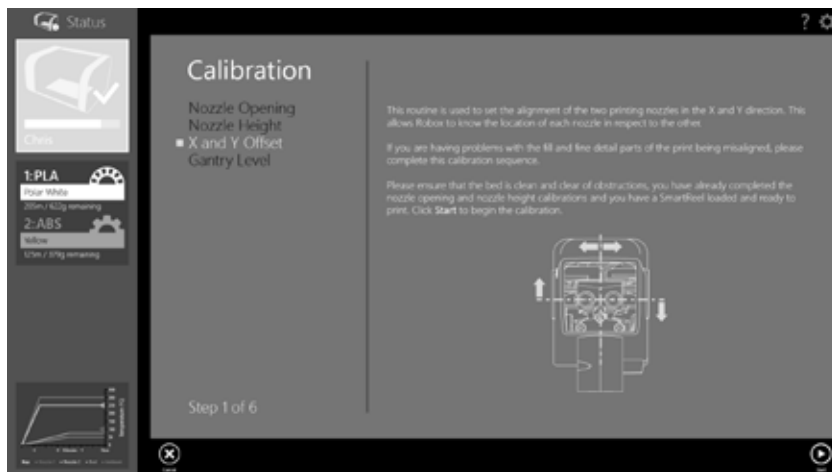

If you are having problems with the fill and fine detail parts of the print being misaligned, this should rectify your problem. There are a number of things you need to check before starting the calibration sequence:

- You have a Robox® SmartReel™ installed in the material dock
- You have already completed the nozzle opening and nozzle height calibrations as described in sections 7.1.1 and 7.1.2.
- Extrusion is working correctly, and material can be extruded from both nozzles - if this is not working, please try completing the Purge sequence under Maintenance - see section 7.2.1
- The bed is clear of all obstructions
- The nozzles are clean with no lumps of filament or degraded material

When you are ready, click **Start** to begin. AutoMaker™ will then heat up the nozzles and produce a plastic part to aid the calibration process.



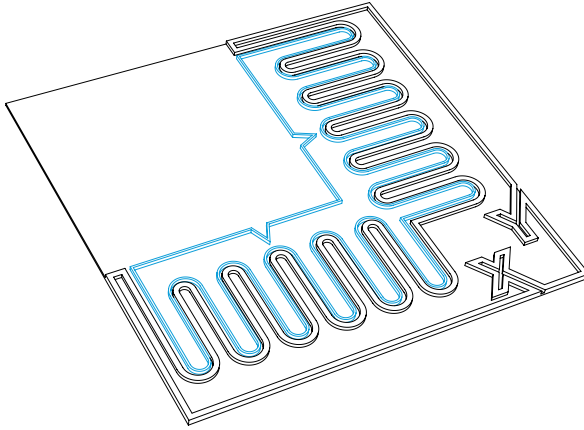

On the illustration above, the output from the fill nozzle is shown in black, with the fine nozzle shown in blue. Once the print has finished, DO NOT remove the part, as the process is not yet complete. If the print didn't complete successfully, you can click the **Retry Print** button on the toolbar.

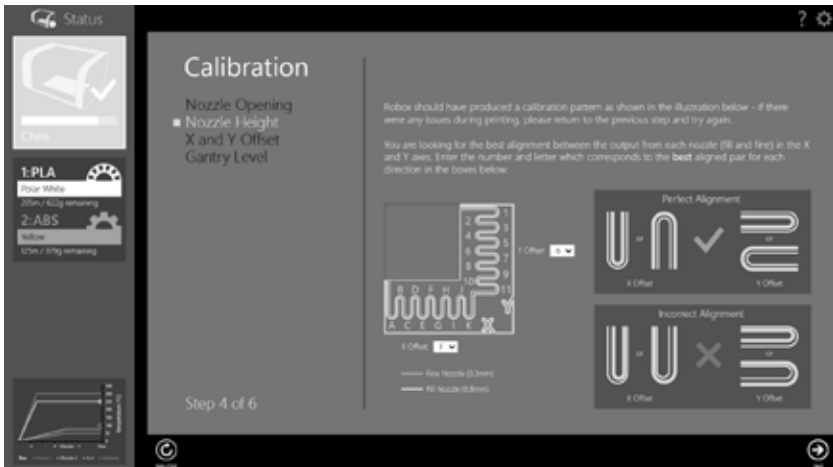

Compare the part on the bed to the image on-screen - you are looking for the best alignment between the output from each nozzle (fill and fine) in the X and Y axes. There are diagrams on the right which show the points you are looking for. Then choose the appropriate number and letter for the profiles with the best alignment and click **Next** to continue.

## 7.0 Calibration and Maintenance

AutoMaker™ will then program the head with the values you have selected, and print some extra areas for verification. It will print a circle in the rear-left corner, followed by a crosshair in the centre.



Perfect Alignment



X Alignment Error



Y Alignment Error



X and Y Alignment Error

If you are still seeing an alignment error, click the **Retry Calibration** button in the bottom left to try again. If you are happy with the result, click **Next** to complete the calibration and program the head.

## 7.2 Maintenance

In order to keep your Robox® in good working condition, a small amount of maintenance is occasionally required. There are a number of routines in AutoMaker™ that guide you through the process.



- AutoMaker™ is continually being improved - please check our website for an updated version of the user manual if you require further information.

### 7.2.1 Purge Nozzles

When changing between two dissimilar materials, care must be taken to ensure the heater block does not reach the degradation temperature of the starting material. The purge routine sets the nozzle temperature to half way between the melting point of the new and old materials and 'purges' the head by ejecting mixed material onto the bed.

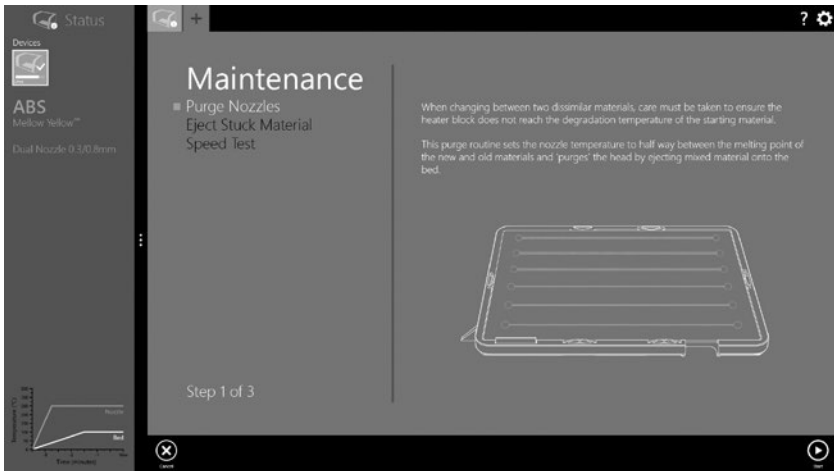

AutoMaker™ will automatically detect if the melt temperature in the loaded material profile differs from the last filament that was used in the print head, and prompt you to complete a purge routine. It is recommended to ALWAYS complete this routine to ensure there are no remnants of degraded material in the head which could cause a nozzle blockage. If you would like to force a purge, it can be accessed from the toolbar on the Status screen.

# 7.0 Calibration and Maintenance

## 7.2.2 Eject Stuck Material

If you are having trouble extruding material, it's possible you could have a nozzle blockage - caused by degraded plastic (material which cannot fully melt as it has been overheated) inside the melt chamber. The extruder fitted in your Robox® does not always have sufficient torque to overcome this blockage, and therefore a manual purge may be required. For more information on this process, please see the solutions page available at <http://robox.freshdesk.com> for instructions.

## 7.2.3 Speed Test

This function is purely for testing the operation of the motors and motion axes. It is provided predominantly for diagnostic purposes, and should not be required during normal operation of Robox®. It simply drives all axes over their full range of movement a number of times at varying speeds to check functionality. You may be asked to perform this test by one of our support team. It can be found on the Advanced Settings - Calibration and Maintenance page - see section 5.3.9.

## 7.2.4 Cleaning

Robox® should be cleaned using a damp cloth and a mild, cleaning product (e.g. soap solution), and then wiped down with a cloth rinsed in clean, clear water. Wipe all surfaces and follow with a clean, dry, soft cloth to buff dry.

**DO NOT USE:** Window cleaning sprays, kitchen scouring compounds or solvents such as acetone, gasoline, benzene, alcohol, carbon tetrachloride, or lacquer thinner. These can scratch and/or weaken surfaces causing small surface cracks.



- **WARNING!** When cleaning your Robox®, please ensure it is isolated from the mains and is fully dry before reconnecting.

## 7.2.5 Print Bed

If you are having any problems with your print adhering to the bed, before trying anything else, clean the bed using the supplied bed cleaning wipes. These are impregnated with Isopropyl Alcohol (70%) which should remove any oily residues which may be affecting the PEI. No other bed preparation should be required to print with a large range of materials.



- **NEVER** clean the PEI print bed using Acetone or other harsh solvents/chemicals - they are unlikely to improve adhesion, and will damage the bed surface.

## 7.2.6 Build Chamber

Always try to ensure that the build chamber remains clear of debris, whether it is mis-extruded filament or otherwise. This debris can get trapped in the various moving parts of the machine and affect homing accuracy and motion, possibly causing damage to Robox®.

Any debris which is fallen through into the area below the bed can be cleaned out by removing the front tray cover (slide firmly towards you) and then tipping forward - a gentle shake should clear it out.

To replace the cover, ensure all clips on the sides of the front tray cover are aligned with their mating features, and then push towards the back of Robox® to 'snap' into place.

## 7.2.7 Extruder

After many hours of printing, there is a possibility that filament debris may have accumulated inside the extruder. If you are having problems with loading/unloading filament or your extruder is skipping - please see the solutions page available at <http://robox.freshdesk.com> for instructions on servicing.

## 7.2.8 Lubrication

In order to keep your Robox® in top working condition, it is essential that you keep all of the motion system lubricated - including the Z drive screws and linear rails. This must be performed at regular intervals (approximately 200 hours of printing). There is a bottle of axis lubricant included in the accessories box which shipped with your Robox® - if this is not available, a light mineral oil would be suitable e.g. sewing machine oil.

To complete this process follow the instructions below:

1. Home all axes using AutoMaker™.
2. Apply a thin smear of lubricant to the X-Rails. The easiest way to ensure the lubricant is distributed across the rails is to apply it on either side of the linear bearings for the X (head) and Y (bed) carriage, and to the drive nuts for the Z axis. If you then run a speed test, this will distribute the lubricant over all axes.

## 7.3 Troubleshooting

This section of the user manual is intended to help you diagnose and fix a wide range of issues you could be experiencing with your Robox®.

Problem / Symptoms	Solution(s)
<p><b>Hardware</b> - My Robox® won't turn on - is it dead!?</p>	<p>Robox® will 'play dead' unless the AutoMaker™ software is running. Also ensure the USB cable is connected, the power switch on the rear of the unit is in the 'On' position, and the fuse in the plug is intact. If you are still experiencing problems, please contact CEL support.</p>
<p><b>Hardware</b> - I'm having trouble getting the first layer of my print to stick to the print bed.</p>	<p>There are a number of possible causes and solutions:</p> <ol style="list-style-type: none"> <li>1. Try cleaning your print bed using the supplied bed cleaning wipes, or a clean cloth soaked in Isopropyl Alcohol.</li> <li>2. There could be a problem with the automatic bed-levelling system - try running the 'Level Gantry' calibration.</li> </ol>
<p><b>Hardware</b> - My motors/bearings are making a 'grinding' sound as the print head moves around the build area.</p>	<p>It sounds like you need to perform some maintenance, try lubricating the drive screws and motion rails using the supplied Axis Lubricant. See section 7.2.8 for more information on maintenance procedures.</p>

**Hardware** - I'm having trouble loading a new reel of filament

Firstly, ensure that you have fed filament all the way to the feed wheels. When you insert the filament, you should hear the extruder motor begin to turn, at this point **continue pushing in** material until the extruder grabs hold of the filament and feeds it all the way to the head. If you do not hear the extruder motor start when you feed in filament, it is likely there is an issue with the 'loaded' switch in the extruder. When no reel is installed, the extruder output switch should appear as 'false/off' in the diagnostics screen (described in section 5.3.10). There should also be no eject button visible on the Status screen. If you do see an eject symbol when no filament is loaded, then there is an issue with your output switch, please contact CEL support - see section 8.4.

**Hardware** - There's a clicking sound coming from my extruder during printing.

1. Verify the material is coming of the reel easily and isn't tangled.
  2. Your extruder may require cleaning - this is a simple procedure that can be performed using a household vacuum cleaner. See section X.X for further information.
  3. Your printhead could be blocked. Try running the purge procedure to clean out any degraded plastic that may have accumulated in the melt chamber.
- If these procedures have no effect, please contact CEL support.



**Printing** - My print is stuck to the bed. Help!

Sometimes, depending on the print material you are using, your print can be stuck to the bed very securely, making it difficult to remove. The first step is to ensure your part and bed have cooled down fully; because different polymers have different shrink rates when cooling, the part will usually cool at a different rate to the PEI sheet, causing them to detach themselves. Because the bed is removable, this should be simple to resolve by removing the PEI sheet - see section 4.5. Once you have removed the sheet, lightly flex it and you should find your print snaps right off.

**Printing** - Object begins to warp and peel away from the bed during printing.

The warp of printed parts is influenced by the 'coefficient of thermal expansion' of the material. This parameter describes the degree to which a polymer changes size as a function of temperature. The higher this parameter, the more a part will shrink as it cools. Because 3D printed parts are hot at the base (due to the heated bed) and at the top (due to the molten material which was deposited last), but cooler in between, the middle of the part can start to shrink at a higher rate. This causes the bottom of the part to warp upwards, and the top to warp downwards. By maintaining the ambient temperature, Robox® attempts to prevent the part shrinking, by allowing the whole object to cool evenly at the end of the print. Therefore when printing materials with a high shrink rate, it is essential that the door remains closed during printing. Using brim can also help with warp at the bottom of the part by increasing the contact surface area with the PEI sheet.

**Software** - I can't get AutoMaker™ to install on my OS.

Firstly, please check that your hardware meets the minimum requirements as stated in section 2.3 and also that you are using a compatible operating system as described in section 2.2.6. If your system meets these requirements, please contact CEL support.

**Software** - My antivirus software has detected a problem with AutoMaker™.

This is likely a 'false positive' based on 'reputation'. Many antivirus packages use a reputation based system to determine the safety of software based on the number of instances that have been seen by other users. As AutoMaker™ is brand new software it may trigger these checks until it has been installed by more users worldwide. It can usually be rectified by restoring the file from quarantine. If you have any further questions please contact CEL support - see section 8.4.

**Software** - I can't find the print button!

The print button only appears when your printer is ready to print. The normal cause is that your filament is not installed. Please see the troubleshooting section "Hardware - I'm having trouble loading a new reel of filament".



8.0

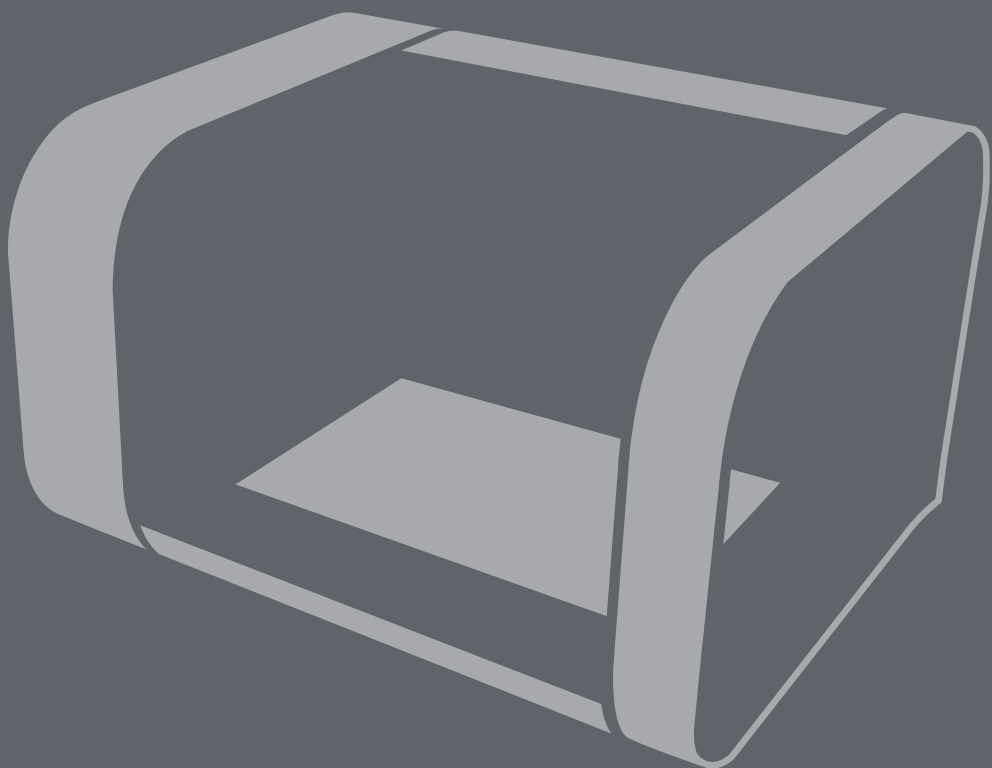

Supplementary  
Information

## 8.1 GCode Commands

This section contains a full list of GCode G and M commands which are applicable to Robox®.

<b>G0</b>	<p>Coordinated Rapid Movement [X Y Z E D B]            E = Extruder 1 (mm<sup>3</sup>), D = Extruder 2 (mm<sup>3</sup>), B= Nozzle Motor (0=closed, 1=fully open) This will move the head to an absolute location at maximum axis speed. e.g. G0 X100 Y100 (move to 100,100)</p>
<b>G1</b>	<p>Coordinated Movement [X Y Z E D B] F            E = Extruder 1 (mm<sup>3</sup>), D = Extruder 2 (mm<sup>3</sup>), B= Nozzle Motor (0=closed, 1=fully open), F=Speed mm/min. This will move the head to an absolute location at the specified feed rate. e.g. G1 X100 Y100 E50 F100 (move to 100,100 while extruding 50mm<sup>3</sup> at 100mm/s)</p>
<b>G4</b>	<p>Dwell S or P            S = Delay (seconds), P = Delay (milliseconds) This will cause all motion to delay for the specified time period. e.g. G4 S100 (wait for 100 seconds) or G4 P500 (wait for 500 milliseconds)</p>
<b>G28</b>	<p>Home [X Y Z]            Home specified axis, e.g. Home X Z will home the X and Z axis in sequence - X is always homed first, and Z always last.</p>
<b>G36</b>	<p>Move filament until slip [E / D F]            E = Extruder 1 (mm<sup>3</sup>), D = Extruder 2 (mm<sup>3</sup>), F=Speed mm<sup>3</sup>/min            This will feed the specified volume at the specified feedrate, until the extruder index wheel detects that the filament is no longer moving.</p>
<b>G37</b>	<p>Unlock door [S]            S = Override Safe Temperature (Bed) (°C)            This will unlock the door immediately if no S value is present, or allow the door unlock at a specified bed temperature. e.g. G37 S50 will unlock the door when the bed temperature reaches 50°C.</p>
<b>G38</b>	<p>Level gantry            Using the input from two G28 Z probes at least 100mm apart in the X direction, this command automatically levels the gantry to make it parallel to the bed.</p>
<b>G39</b>	<p>Level bed (compensate Z according to Y)            Using the input from two G28 Z probes at least 100mm apart in the Y direction, this command automatically drives the Z axis during printing to keep the nozzle the same distance from the bed.</p>
<b>G90</b>	<p>Use absolute coordinates on X/Y/Z axes (default)            This command causes Robox® to interpret all moves as 'absolute', i.e. move to the location specified. e.g. G1 X100 Y100 will move to the fixed location 100,100. This is the default behaviour of the firmware.</p>
<b>G91</b>	<p>Use relative coordinates on X/Y/Z axes            This command causes Robox® to interpret all moves as 'relative' i.e. move to the location relative to your current position. e.g. if the head is at position 100,100 - G1 X20 Y20 will move the head to 120,120, not 20,20.</p>

## 8.0 Supplementary Information

G92	Set X/Y/Z position to coordinates given This command tells the software the location of the printhead - it is not necessarily the same as the physical position of the head.
T0	Tool 0 (Fine Nozzle - 0.3mm) This command selects the fine printing nozzle.
T1	Tool 1 (Fill Nozzle - 0.8mm) This command selects the fine printing nozzle.
M103	First layer target temperature [S] S=Override Temperature °C This command sets the nozzle temperature for the first layer of printing using data supplied from the reel EEPROM. [S] provides a manual override for custom temperature. e.g. M103 will set the nozzle temperature to the value stored on the reel / previous value sent, M103 S240 sets it to 240°C.
M104	Set nozzle target temperature [S] S=Override Temperature °C This command sets the nozzle temperature using data supplied from the reel EEPROM. [S] provides a manual override for custom temperature. e.g. M104 will set the nozzle temperature to the value stored on the reel / previous value sent, M104 S205 sets it to 205°C.
M105	Show temperatures and PWM output, voltage detection (T:aa @bb B:cc (^/\$)dd A:ee *ff) aa = Nozzle Temperature Setpoint (°C), bb = Nozzle Heater PWM (0-255), cc = Bed Temperature Setpoint (°C), dd = Bed Heater PWM (0-255) - ^ denotes 240V supply, and \$ denotes 115V supply, ee = Ambient Temperature Setpoint (°C), ff = Ambient Fan PWM (0-255). This command shows the status of all heaters and temperature settings.
M106	Head Fan on [S] S=Speed (0-255) This command sets the speed of the fan on the print head. e.g. M106 S255 sets the fan to 100% power, M106 S128 sets it to 50%.
M107	Head Fan off This command turns off the head fan, but only if the nozzle temperature is lower than 60°C. The minimum fan speed if the nozzle temperature >60°C is 50% (S128).
M109	Wait for nozzle temperature to reach target This command issues a stop to all commands until the nozzle reaches it's target temperature.
M114	Display current position [X Y Z B] This command displays the current position of all axes e.g. M104 will output all positions to the console in the form M104 X** Y** Z** B**.
M84	Turn off motors until next move This disables all stepper motors until a G0 or G1 is sent.
M92	Set axis steps per unit [X Y Z E D B] This command is only really for advanced use, as these values should never need to be changed. It sets how many microsteps are equivalent to one unit of motion i.e. for X, Y and Z, this is 1mm, for E and D, this is 1mm <sup>3</sup> and for B this is the equivalent to the angle at full open.
M113	Show Z delta This command displays the difference in height between the last two Z height probes.
M115	Show firmware version Displays the firmware version which is installed on the Robox®.

M119	<p>Show switch state [X Y Z Z+ E D B Eindex Dindex]  X = X Endstop, Y = Y Endstop, Z = Z Probe, Z+ = Z Top Endstop, E = Extruder 1 Output Switch, D = Extruder 2 Output Switch, B = Nozzle Homing Switch, Eindex = Extruder 1 Index Wheel, Dindex = Extruder 2 Index Wheel.  This is provided for diagnostic purposes and shows the state of all switches on Robox®.  e.g. M119 X:1 Y:0 Z:0 Z+:0 E:1 D:1 B:0 Eindex:0 Dindex:1 - 1 = Switch Closed, 0 = Switch Open</p>
M120	<p>Load filament [E D]  E = Extruder 1, D = Extruder 2. This executes the loading sequence for the specified extruder, however it is rarely required as this is triggered by movement of the indexing wheel when the output switch is open (i.e. no filament loaded).</p>
M121	<p>Unload filament [E D]  E = Extruder 1, D = Extruder 2. This executes the unloading sequence for the specified extruder when the output switch is closed (i.e. filament loaded).</p>
M128	<p>Head lights off  This turns the LEDs on the bottom of the printing head off.</p>
M129	<p>Head lights on  This turns the LEDs on the bottom of the printing head on.</p>
M139	<p>Set bed first layer target temperature [S] S=Override Temperature °C  This command sets the bed temperature for the first layer of printing using data supplied from the reel EEPROM. [S] provides a manual override for custom temperature. e.g. M103 will set the bed temperature to the value stored on the reel / previous value sent, M139 S100 sets it to 100°C.</p>
M140	<p>Set bed target temperature [S] S=Override Temperature °C  This command sets the nozzle temperature using data supplied from the reel EEPROM. [S] provides a manual override for custom temperature. e.g. M104 will set the bed temperature to the value stored on the reel / previous value sent, M140 S120 sets it to 120°C.</p>
M170	<p>Set ambient target temperature [S] S=Override Temperature °C  This command sets the ambient temperature using data supplied from the reel EEPROM. [S] provides a manual override for custom temperature. e.g. M104 will set the ambient temperature to the value stored on the reel / previous value sent, M170 S35 sets it to 35°C.</p>
M190	<p>Wait for bed temperature to reach target  This command issues a stop to all commands until the bed reaches its target temperature.</p>
M201	<p>Set maximum acceleration for moves [S] S=Acceleration in steps/s<sup>2</sup>  This command sets the maximum acceleration for ALL motion axes. Default is 12 steps/sec<sup>2</sup>.</p>
M202	<p>Set maximum speeds [X Y Z E D]  This command sets the maximum speed of each axis, in its appropriate units. X, Y and Z are in mm/s, E and D are in mm<sup>3</sup>/s.</p>
M301	<p>Set nozzle heater parameters P, F, D, B, T, U  This command is only really for advanced use, as these values should never need to be changed. It is used to adjust the control parameters for the nozzle heaters.</p>
M302	<p>Set bed heater parameters P, F, D, B, T, U  This command is only really for advanced use, as these values should never need to be changed. It is used to adjust the control parameters for the bed heater.</p>

## 8.0 Supplementary Information

M303	<p>Set ambient temperature control parameters P, F, D, B, T, U</p> <p>This command is only really for advanced use, as these values should never need to be changed. It is used to adjust the control parameters for the ambient fan.</p>
M500	<p>Store parameters to EEPROM</p> <p>This writes any new settings to the firmware. If not stored using M500, settings will be lost when the power is cycled.</p>
M502	<p>Revert to default parameter values</p> <p>This resets the firmware parameters to the factory defaults. Save using M500.</p>
M503	<p>Show settings</p> <p>This outputs the current firmware settings to the console.</p>
M510	<p>Invert axis [X Y Z E D B]</p> <p>Where 0=false, 1=true. This command is only really for advanced use, as these values should never need to be changed. It causes all motion on the specified axis to occur in the opposite direction.</p>
M520	<p>Set axis travel [X Y Z]</p> <p>This command is only really for advanced use, as these values should never need to be changed. It specifies the length of each axis in mm.</p>
M526	<p>Invert switch inputs [X Y Z Z+ E D B]</p> <p>Where 0=false, 1=true. This command is only really for advanced use, as these values should never need to be changed. It inverts the output from the specified switch (X, Y, Z and Z+ endstops, extruder 1 and 2 output switches, nozzle homing switch).</p>
M527	<p>Set home distance [X Y Z E D B]</p> <p>This command is only really for advanced use, as these values should never need to be changed. For X, Y and Z, it specifies the distance the head can move beyond the point that the endstop is activated, and therefore it defines the homing speed. For E and D, this defines the distance filament travels from the extruder output switch to the entry point of the head along the Bowden tube.</p>
M906	<p>Set motor current [X Y Z E D B]</p> <p>This command is only really for advanced use, as these values should never need to be changed. It sets the current of the specified motor in Amps. e.g. M906 X1.2 would set the X motor driver output to 1.2A.</p>
M907	<p>Set motor hold current (Amps) [X Y Z E D B]</p> <p>This command is only really for advanced use, as these values should never need to be changed. It sets the hold current of the specified motor in Amps. e.g. M907 Z0.3 would set the Z motor driver hold output to 0.3A.</p>
M908	<p>Set extruder motor reduced current (Amps) [E D]</p> <p>This command is only really for advanced use, as these values should never need to be changed. This sets the current of the extruder motor when a G36 command is issued - move until slip. This helps prevent 'stripping' of the filament by causing the motor to skip rather than the teeth skipping on the filament. e.g M908 E0.7 would set the extruder 1 slip current to 0.7A.</p>
M909	<p>Set filament slip detection threshold (mm) [S]</p> <p>This command defines the difference between how far filament has been told to travel, and how far it travels in order to trigger a filament slip error. i.e. if this value is set to 2mm, and the filament is told to travel 10mm, a error will be triggered if it moves &lt;8mm.</p>



## 8.2 Frequently Asked Questions

Below is a list of FAQs relating to Robox®.

### 8.2.1 Hardware

- **What is the build volume of Robox®?**  
Robox® has a build area of 210x150x100mm – or a volume of 3.15 litres. Prints taller than 100mm can be scaled or we are adding functionality to AutoMaker™ which will automatically cut your part into sections for reassembly after the printing. This way we can keep our small desktop footprint but not restrict the parts you print.
- **What is the maximum printing resolution of Robox®?**  
The minimum layer height (or maximum layer resolution) is currently 20 microns and the smallest nozzle is 300 microns in diameter – this means theoretically the smallest single feature can be 300 microns in diameter and 20 microns in height (i.e. really small!)
- **What is the build speed?**  
We are currently in the middle of a test programme to work out the limits of the motors and axes, and how these affect print quality, we should be able to publish some maximum printing and travel speeds soon – but be assured, it's fast!
- **What about other specifications?**  
See section 2.2.
- **Can you use third party printing filament with Robox?**  
Robox® has not been tied to only official materials - any high quality 1.75mm filament can be used - but... users wouldn't get the full plug and print experience that Robox® offers. Some of the cool features like pausing a print and changing colours rely on the printer knowing what's been loaded and that's where our SmartReel™ can smooth out the process and enhance the experience. The best printing results will be achieved using official materials, as they come supplied with a print profile which has been extensively tested for a perfect print every time.

Why would you not want to use official filament? It's extremely cost competitive and the quality is second to none, but we don't want to tie you in. Not all filaments are good quality, and some might not only give you

poor print results but damage Robox® - we can't take responsibility for poor quality filament causing damage to the product.

- [Where can I find mechanical, chemical and safety specifications \(MSDS\) for the print materials?](#)

These will be available alongside each Robox material on our website – [www.cel-robox.com/materials](http://www.cel-robox.com/materials).

- [What is the life expectancy \(hours\) of the printer?](#)

Robox is currently undergoing rigorous life-cycle testing and from initial results, it looks like 2000 hours of printing is possible before any maintenance is required.

- [Can you explain the resolution metrics \(feature size, layer thickness, X/Y resolution etc.\)?](#)

**Feature Size** – this refers to the smallest feature that can be realistically produced in the X+Y dimension (parallel to the bed), and is dependent on nozzle size – for Robox® the minimum feature size is 0.3mm (300 microns).

**Minimum Layer Thickness** – this is the thinnest layer that can be extruded by Robox®, and has the greatest impact on surface finish. Robox® can print with 20 micron layers, producing an almost completely smooth outside perimeter.

**Resolution** – this specifies the theoretical maximum resolution, i.e. the smallest motion that can be performed by the motors and the linear components. For example if a step motor rotates 1.8° per step, and the controller can produce 16 microsteps that equates to  $((360/1.8) * 16) = 3200$  steps per revolution. If this motor is connected to a screw with a pitch of 0.5mm (as is found on our Z axis), this equates to  $(0.5/3200) = 0.15625$  microns per microstep or 2.5 microns per whole step - see section 2.2 for more information.

- [Is Robox® compatible with all AC supplies?](#)

Robox® includes a 230/110V internal switching power supply, and will include the appropriate mains lead for your country.

## 8.2.2 Software

- **What operating systems are supported?**  
AutoMaker™ can be used with Microsoft Windows (7, 8), Mac OS x (10.6 x64/10.7+) and Ubuntu Linux (12.04+). For more information, see section 2.2.
- **What kind of files does Robox accept? Can I only use your library?**  
AutoMaker™ software will currently accept the industry standard .stl and .obj format 3D models. These can be exported by most 3D design packages available including SolidWorks, Creo/ProEngineer, NX, OpenSCAD, TinkerCAD, 123d Design etc. In future, we also plan to support the new Microsoft 3D Builder software and .amf/.3mf format for Windows 8.1 support.
- **Can you use AutoMaker™ to design parts?**  
Not yet - the included AutoMaker™ software is for controlling and monitoring Robox® and laying out print jobs, not for actually designing parts. There are a number of solutions available online which will allow you to design your own parts – including Thingiverse Customizer, TinkerCAD, Geomagic Design, OpenSCAD, Rhino, 123d Design and 123d Sculpt.
- **Does AutoMaker™ have a file size restriction for .stl/.obj files?**  
There isn't any restriction on file size – the performance of the 3D visualisation may be affected depending on the computer hardware the software is running on.

### 8.2.3 Printing

- **How do you support overhangs in the print?**

AutoMaker™ automatically generates easy to remove support when printing with the single material (but dual nozzle) head. Because of the HeadLock™ system, switching to a dual material head with dual extruders in future will be a snap. This upgrade will allow Robox to print with dissolvable support materials such as PVOH (Polyvinyl Alcohol) and HIPS (High Impact Polystyrene) - see section 6.2.

- **Is ABS safe to print with?**

Molten ABS is not actually a toxic material, as some comments suggest. There are some research projects that suggest there are ultrafine airborne particles which are released when the plastic is melted, and the current advice is to suggest “caution when operating in inadequately ventilated or unfiltered indoor environments.” Just like mobile phone radio waves the research is inconclusive at this stage, but has captured a lot of media attention.

The research paper can be found at:

<http://www.sciencedirect.com/science/article/pii/S1352231013005086>

- **If I put two items on the bed, is it possible to print one by one rather than both together?**

It is possible to print one at a time, but because Robox builds vertically, a large exclusion zone is required around object 1 to prevent the head bashing into object 2 – this is possible with very small items.

- **How many parts can be printed from one SmartReel™?**

This is obviously completely dependent on the size of the model, it's fill density and the quality setting chosen. The AutoMaker™ software will provide an estimate of how long the print will take, as well as how much material will be required (while also checking there is enough material available on the reel). Each reel holds ~650g of print material.

## 8.3 Glossary of Terms

This section contains a comprehensive glossary of frequently used 3D printing and custom manufacturing terms and jargon.

1st Layer	<ul style="list-style-type: none"> <li>This is the first layer of plastic which is laid down on the build plate at the start of a print. It is the most important layer of a print, as it is used for adhering the part to the bed.</li> </ul>
3D Model	<ul style="list-style-type: none"> <li>A mathematical representation of the three-dimensional surface of an object (in the case of Robox®) constructed using triangles, also known as a mesh. There are many file formats for this, with Robox® currently accepting .stl and .obj.</li> </ul>
3DP	<ul style="list-style-type: none"> <li>Abbreviation of 3D Printing</li> </ul>
ABS	<ul style="list-style-type: none"> <li>Acrylonitrile Butadiene Styrene, a thermoplastic used as a 3D printer material. It produces tough, impact-resistant parts which make excellent functional prototypes. It can be tapped, sanded, painted and vapour polished allowing for high quality finishing.</li> </ul>
Accuracy	<ul style="list-style-type: none"> <li>Generally used to describe the theoretical accuracy of the motion system. This is calculated from the step accuracy of the stepper motor used for control and the pitch of the leadscrew / belt. See section 2.2 for accuracy specifications.</li> </ul>
Acetone	<ul style="list-style-type: none"> <li>A colourless, flammable liquid also known as propanone - a solvent which will dissolve ABS and can be used as a cement for gluing parts together. It can also be used for 'vapour smoothing' see section 6.3.</li> </ul>
Additive Manufacturing (AM)	<ul style="list-style-type: none"> <li>The process of constructing an object by selectively adding material, rather than starting with a block of material and cutting away what you don't need - see subtractive manufacturing.</li> </ul>
Ambient Temperature	<ul style="list-style-type: none"> <li>This refers to the air temperature inside the build chamber during the print. Maintaining this at a stable temperature can help to reduce warping of parts as they are produced by encouraging even cooling.</li> </ul>
.AMF	<ul style="list-style-type: none"> <li>AMF serves as an alternative to the STL file format based on XML which supports units, colour, textures, curved triangles, lattice structures, and functionally-graded materials—features that the STL format does not support.</li> </ul>

# 8.0 Supplementary Information

## AutoMaker

The included software package which is used for controlling all elements of your Robox®, including printing, layout, calibration and maintenance.

## Axis (Axes)

Describes a single direction of movement in a 3-dimensional coordinate system. X axis runs left to right, Y axis is front to back and the Z axis represents what would typically be considered "vertical".

## Backlash

Sometimes called lash or play, it describes the 'slack' in a mechanical system. In the case of the pulleys and belts, it could be caused by the tooth profile of the belt not matching the pulley, or by the pulley being loose on the shaft which drives it.

## Bed

The surface at the base of the 3D printer on which parts are actually made. Robox® has a removable PEI bed surface to allow for easy part removal. Also known as a build plate.

## Belt

The toothed gear belts which are used in conjunction with a drive pulley to transfer movement from the motors to other parts of a machine. Usually fibre-reinforced to prevent stretching.

## Bowden Tube

This is the tube which delivers the filament to the print head. It is manufactured from PTFE to reduce the friction on the internal surfaces while maintaining flexibility.

## Bridge

This refers to a feature in the printed object where an unsupported flat surface is produced by essentially printing 'in thin air'. It is achieved by moving the printhead more slowly than perimeters, and bonding the extrudate to either side of the gap so that it is stretched and can cool before it begins to 'sag'.

## Brim

'Brim' is a term applied to 3D printing which describes a large flat area which is printed around the part to help with bed adhesion and warping - like the brim of a hat. See section 5.5.3.

## Build Chamber

This is the enclosed area of Robox® where parts are produced, and is designed to maintain the ambient temperature and prevent draughts from affecting the quality of your print.

## Build Envelope

This refers to the maximum dimensions of an object which can be produced with Robox® - 210x150x100mm (LxWxH)

## Build Plate

See bed.

## CAD

Computer Aided Design - used for designing objects.

## Calibration

The mostly automated process of adjusting software/hardware parameters in AutoMaker™ to take into account any differences in the manufacturing/assembly process of Robox®. See section 7.1.

## Carriage

This refers to a moving assembly which is constrained to one axis - Robox® has 3 - the Z carriage which holds the X motor and rails, the X carriage that holds the print head, and the bed could be described as the Y carriage.

## Cartesian Axis

A coordinate system which describes the location of an object in three dimensions perpendicular to each other - X, Y and Z.

## Caustic Soda

See Sodium Hydroxide.

## CNC

Abbreviation of Computer Numerical Control - controlling motion using a computer which sends instructions as GCode.

## Console

A means of entering CNC commands manually by sending typed text instructions.

## Delamination

A defect in a 3D printed object where layers have not correctly fused together, resulting in a gap between layers. It can be caused by underextrusion, incorrect material process parameters or by excessive warping/shrinkage.

## Dessicant

A chemical substance which absorbs moisture from the surrounding environment.

## Drive Screw

Also known as a lead screw, this is a thread which is used to convert rotational motion (from a stepper motor) into linear motion. In Robox®, drive screws are used to move the gantry up and down.

## Dual Extrusion

A type of 3D printing where two different materials can be extruded on the same layer using two nozzles.

## EEPROM

Abbreviation of Electrically Erasable Programmable Read Only Memory - the type of memory (on a microchip) which is used to store parameters in the printhead and SmartReel™.

## Endstop

Also known as a limit switch, this refers to a microswitch which is used to define the limits of a motion axes. Also see Homing.

## Extrudate

This refers to material which has been extruded from one of the nozzles on the printhead.

## 8.0 Supplementary Information

### Extrude

The act of placing the build material on the build platform, normally by heating thermoplastic to a liquid state and pushing it through one of the nozzles on the printhead.

### Extruder

This device is used for pushing the filament to the head along the Bowden tube. It uses two contra-rotating feedwheels to pinch the filament and feed it in a very controlled manner using a stepper motor.

### Faceted

This refers to the appearance of a low-resolution 3D model, where individual polygons are visible in the printed object. The resolution of a 3D model is controlled by 3 parameters - chord length, step angle and step size. Reducing the size of these three values will result in a higher resolution model (smoother surface).

### Feed Rate

This describes the speed at which motion axes move, usually in mm/s and can refer to the X, Y, Z and extruder 'axes'.

### Feedstock

See filament.

### FFF

Fused Filament Fabrication. Where a filament of one material (plastic, wax, metal, etc.) is deposited on top of or alongside the same (or similar) material making a joint (by heat or adhesion).

### Filament

The 'feedstock' for a FFF 3D printer - a thermoplastic which has been extruded into a 1.75mm diameter 'wire' which is fed to the print head and melted before being extruded onto the build plate.

### Fill

This describes all extruded material on the inside of a printed object. It's density can be varied (as a percentage) between fully hollow and fully solid - see Fill Density.

### Fill Density

This describes the density of the fill - 0% for a hollow object, 100% for a fully solid object.

### Firmware

This is the computer program which runs on the hardware itself and is stored in flash memory on the mainboard.

### Flash Storage

This refers to the storage available on Robox® to store GCode print instructions during printing. It also maintains a history of previous prints, allowing them to be reprinted without reslicing. It is cyclic storage (once full, begins to overwrite from the beginning) which is not accessible on any device except Robox®. A microSD card is used as the storage medium.



## Flow Rate

This describes the rate of extrusion from the nozzle - normally measured in  $\text{mm}^3/\text{s}$ .

## Footprint

This is the amount of flat area Robox® occupies when stood on a surface - 370x340mm.

## Gantry

This describes the assembly which includes the Z carriages, X rails and X carriage. Its level is adjustable using two independent Z drive screws.

## GCode

The industry standard language for CNC control commands - it has two distinct subsets - G and M codes, where G codes are motion commands, and M codes are logic commands, such as heater control.

## HeadLock™

Refers to the printhead replacement system in Robox® - it allows you to change the printhead quickly and easily.

## HIPS

High Impact Polystyrene - a simple thermoplastic which is frequently used as dissolvable support material as it bonds well to ABS and can be dissolved in Limonene, leaving the ABS part intact - see section 6.2.2.

## Homing

As there is no direct feedback from the stepper motor in terms of position, homing is how Robox® determines the location of all axes before starting a print. Each axis moves until it reaches its endstop, which is then defined as the origin. Because the software knows the length of each axis, software limits can be used at the other end of travel.

## Hot End

This commonly refers to the heated nozzle section of the extrusion system and includes the heater block and nozzles inside the printhead.

## Hygroscopic

This describes the tendency for some thermoplastics to absorb moisture from the air - see section 4.3.

## Infill

See fill.

## Kapton® Tape

Kapton® is a trade name of polyimide, frequently used for high temperature adhesive tapes and films. Many other printers use Kapton® film as a bed surface, however in Robox®, PEI removes the need for any coating on the bed.

## Layer Height

This describes the height in mm of each individual layer of the 3D printed object. The thinner each layer is, the smoother the appearance of the outside surface will be, reducing the 'stair stepping' effect. Thinner layers = more layers = longer print.

## Levelling

This refers to the process of ensuring the nozzle is always the same distance from the print bed to ensure accurate extrusion, good base surface finish and adhesion. Robox® performs the operation automatically in both dimensions, by adjusting the level of the gantry and continually adjusting its height as the bed moves back and forth.

## Linear Bearing

This is a mechanical component which is used to constrain motion to 1 DoF (Degree of Freedom) - i.e. it can only move along a rail and cannot rotate. Linear bearings are used in the bed, Z carriage and X carriage to ensure the accurate position of the printhead.

## Macro

This refers to a sequence of GCode instructions which are executed sequentially to perform a particular function.

## Manifold

This is a term which is used to describe whether a surface model contains any gaps in its surface - i.e. whether it is 'watertight'. Non-manifold surface models may produce errors in slicing, as the software is unable to define that edge.

## MEK

Methyl ethyl ketone, also known as butanone is commonly used as an industrial solvent and polymer cement. It can be used for joining together printed parts and 'vapour smoothing' but must be used with care, as it can irritate skin and eyes. See section 6.3.

## Mesh

See 3D Model.

## Micro-Manufacturing

A term used by us to describe the manufacture of objects on your desktop - i.e. a personal factory. Also used in industry to describe the manufacture of very small objects.

## Microstepping

A method of increasing the number of steps per rotation of a stepper motor by varying the supply to the coils, allowing for increased resolution and smoother operation.

## Model

See 3D Model

## Nozzle

This is the part of the printhead through which material is extruded. Robox® has two nozzles of different diameters - 0.3mm and 0.8mm - with the smaller being used for fine details and the exterior surface of the part, and the latter being used for infilling the part at high speed by extruding a large amount of material at once.

## Nozzle Height

On Robox® this is used to describe the difference between the mechanically determined surface position (the bed) and the actual position.

## Nozzle Opening

On Robox® this describes the point at which plastic begins to flow from the nozzle, based on the position of the needle valve.

## Nylon

Nylon or polyamide (PA) is an engineering grade thermoplastic used in a variety of applications. It is extremely tough and durable, making very strong functional parts.

## .OBJ

Abbreviation of OBJect - a file format used to define a 3D model similar to .STL, but an .OBJ file can contain multiple models and also colour/texture data when used in conjunction with a .MTL (material) file.

## Ooze

This is a phenomenon experienced on many other FFF printers, where molten plastic continues to flow from the nozzle when the extruder has stopped. It is conventionally compensated for using a 'retract', where the filament is pulled back to 'suck' molten material away from the tip of the nozzle. Robox® uses a needle valve system to stop the extrusion as required at the tip of the nozzle, resulting in minimal ooze.

## Overhang

Describes an unsupported area of a 3D printed model. When automatic support generation is enabled, an angle threshold is used to define where support is generated - see section 5.5.8.

## Parametric

(Adjustable in all dimensions. A parametric model is one that can be resized and or distorted to suit the user's needs. In CAD software, you can resize individual features (e.g. holes, ribs etc.), as opposed to a mesh (surface model), which is more difficult to adjust.

## PEI

Also known by the trade name Ultem® - this is a high performance engineering thermoplastic called Polyetherimide. The bed surface of Robox® is constructed from it, as it bonds particularly well to molten ABS and PLA - important for bonding the first layer to the bed.

## Perimeter

In FFF used to describe an extrusion path that runs around the perimeter of the object. e.g. number of perimeters sets the wall thickness of the object.

## PLA

Poly(lactic) Acid. A biodegradable thermoplastic polymer manufactured from corn starch which is frequently used as a 3D printer material.

PP

Polypropylene - a 'waxy' flexible thermoplastic which can be used for 3D printing, however it is particularly susceptible to shrinkage and warping issues due to its large thermal expansion coefficient.

Print Head

This is the 'end-effector' of Robox® which can perform a number of different functions depending on the model. The standard model is a single material, dual nozzle FFF head for producing 3D prints from a range of thermoplastic filaments.

PFA

Perfluoroalkoxy alkane - A fluoropolymer with similar properties to PTFE.

PTFE

Polytetrafluoroethylene (Teflon®) - A high temperature engineering thermoplastic with an extremely low coefficient of friction - used to line the filament path to the head.

Pulley

More specifically - a timing pulley - used for translating rotational motion into precise linear motion. The pitch of the belt and the number of teeth on the pulley defines the resolution.

Purge

When switching between two dissimilar materials, it is important to remove the old material from the head completely to prevent blockages. Purge is a routine that chooses an intermittent melt point and forces through material to effectively switch between materials - see section 7.2.1.

PVA/PVOH

Polyvinyl Alcohol - A water-soluble filament used as 3D printing material, often for dissolvable support. See section 6.2.1.

QuickFill™

This refers to the twin nozzle system used by Robox® for reducing overall print times. By using a fine and fill nozzle, the exterior of the part can be produced slowly and carefully by the smaller nozzle, and then the inside can be filled quickly with the larger nozzle.

Raft

A technique used to prevent warping. Parts are built on top of a 'raft' of disposable material instead of directly on the build surface. The raft is larger than the part and so has more adhesion. Similar to brim in functionality.

Rail

A hardened and ground steel round bar used for constraining linear motion to one DoF.

.ROBOX

A Robox® file - contains an AutoMaker™ project which includes your layout of objects on the print bed and all associated print settings and slicing parameters.

.ROBOXFILAMENT	<ul style="list-style-type: none"> <li>• A Robox® filament definition file - contains material properties for a particular filament e.g. melt temperature.</li> </ul>
.ROBOXHEAD	<ul style="list-style-type: none"> <li>• A Robox® head definition file - describes a particular head type and associated default parameters.</li> </ul>
.ROBOXPROFILE	<ul style="list-style-type: none"> <li>• A Robox® print profile - contains slicing parameters</li> </ul>
Repository	<ul style="list-style-type: none"> <li>• (Typically) an online store of 3D models for printing.</li> </ul>
RepRap	<ul style="list-style-type: none"> <li>• A RepRap machine is a rapid prototyping machine that can manufacture a significant proportion of its own parts.</li> </ul>
Resolution	<ul style="list-style-type: none"> <li>• Typically used to describe the layer height and positional accuracy of a 3D printer. Please refer to specifications in Section 2.2.</li> </ul>
Retraction	<ul style="list-style-type: none"> <li>• Often used in other printers to control ooze - describes the 'pulling back' of filament from the print head. Also see Ooze.</li> </ul>
Robox® Account	<ul style="list-style-type: none"> <li>• Your Robox® account must be registered when using AutoMaker™ for the first time to allow us to offer effective support and send software updates - see section 3.5.</li> </ul>
Routine	<ul style="list-style-type: none"> <li>• See Macro.</li> </ul>
RP	<ul style="list-style-type: none"> <li>• Abbreviation for Rapid prototyping. Creating an object in a matter of hours using additive manufacturing.</li> </ul>
Shell	<ul style="list-style-type: none"> <li>• Used to describe the outside surfaces of a 3D model.</li> </ul>
Silica Gel	<ul style="list-style-type: none"> <li>• A desiccant which can be used for reducing the water content of filament. It can be reactivated by slow oven drying or microwaving - times depend on the quantity - see section 4.3.</li> </ul>
Slice	<ul style="list-style-type: none"> <li>• The process of converting a 3D model into individual layers or 'slices' for printing. Toolpaths are generated to describe the motion of the printhead and extruder in GCode.</li> </ul>
Slicer	<ul style="list-style-type: none"> <li>• The part of the software which is responsible for producing GCode instructions for printing from a 3D model.</li> </ul>
SmartReel™	<ul style="list-style-type: none"> <li>• A Robox® filament reel which includes an EEPROM for storing material parameters - allowing for instant machine set up when it is installed in the dock. See section 5.2.2.</li> </ul>
Sodium Hydroxide	<ul style="list-style-type: none"> <li>• A highly caustic alkali salt which can be used in solution to dissolve some types of dissolvable support material - see Section 6.2.3.</li> </ul>

## Solid Model

A type of CAD model which is represented by geometrical features (circles, rectangles etc.), rather than a list of vertices which form a polygonal mesh (surface model). Example of solid model file formats include .STEP and .IGES and they can be exported from many CAD packages.

## Spool

Another term for the filament reel - see SmartReel.

## Stair Stepping

A phenomenon common to all FFF printers to varying degrees, it describes the appearance of individual layers, particularly visible on surfaces close to horizontal at larger layer heights. To minimise this effect, you must reduce the layer height.

## Step Angle

The angle of a discrete increment of rotation of a stepper motor.

## Stepper Motor

DC Motors which operate only in discrete increments of rotation (steps). Robox® uses motors with a step angle of 1.8°, meaning there are 200 discrete steps per rotation.

## .STL

Short for Stereo Lithographic, the most common file format of 3D models for 3D printing. It only contains geometry data in the form of a polygonal mesh, and is slowly being replaced by more advanced standardised formats such as .AMF.

## Stringing

A print defect characterised by thin 'strings' of polymer between separate extrusion paths. It is caused by ooze - as the head travels to another location, it drags a string of molten plastic from the head, affecting the surface finish of the part.

## Subtractive Manufacturing

This is the traditional means by which an object is manufactured, usually by machining. Starting with a 'blank' of raw material, you cut away the areas you don't require, rather than just building the areas you do - see Additive Manufacturing.

## Support Material

Support material describes printed material which is not part of the desired object, but is produced for supporting areas which are not sufficiently supported. Because FFF relies on laying down material on top of a previous layer, it cannot print effectively in thin air - except bridges over a short distance. It can be produced from the same material as the model (Breakaway Support) or a different material which can be removed by chemical means (Dissolvable Support). See Section 6.2.

## Surface Finish

This describes the quality of the outside surfaces of the part, which can be affected by a wide range of factors.

## Surface Model

Describes a type of 3D model which only contains surface data in the form of a polygonal mesh. They do not have to be 'manifold' and can therefore cause issues with slicing if not prepared correctly.

## Thermoplastic

This is a type of polymer which softens on heating, allowing it to be formed into a different shape. This differs from a thermoset plastic, which is formed by a chemical reaction and does not soften on heating, but will degrade.

## Toolpath

This describes the motion that the printhead takes to produce a layer written in GCode motion coordinates.

## Transition Point

This term is used to describe the point at which the solid filament becomes molten in the head assembly.

## Underextrusion

A print defect characterised by a lack of material being extruded, leading to surface finish errors and bad layer bonding. It is usually caused when the extruder cannot force filament into the 'hot-end' fast enough, due to blockage, softened/wet filament, or incorrect material parameters.

## Vapour Smoothing

This is a process used to smooth out the surface of a 3D printed model by vaporising a solvent and then allowing to condense on the surface of the model - causing partial melting and a smoothing effect. See Section 6.3.

## Viscosity

Viscosity is a property of fluids determining its resistance to flow. The higher the viscosity, the more difficult a material will be to extrude or dispense (more energy/pressure will be needed).

## Warp

A print defect caused by uneven cooling of the part, particularly severe in certain materials such as PP, HDPE and ABS. The enclosed build chamber of Robox® is designed to help reduce these effects, by causing the part to cool down uniformly at the end of the print and reducing draughts.

## 'Watertight'

See Manifold.

## WPC

Wood Polymer Composite - a composite material produced from wood 'flour' and a thermoplastic. Can be used for printing 'wood like' objects.

## X Axis

- This is the axis which controls the motion of the head left and right along the X rails, driven by a belt and pulley system.

## X Carriage

- The X carriage contains the HeadLock™ system for attaching different print heads and moves left to right along the X rails.

## Y Axis

- This is the axis which controls the motion of the bed forwards and backwards along the Y rail, driven by a belt and pulley system.

## Z Axis

- This is the axis which controls the motion of the gantry up and down along the Z rail, driven by leadscrew.

## Z Carriage

- These are the plastic housings which hold the X rails perpendicular to the Z axis and form the two sides of the gantry.



## 8.4 Contact Us

This section contains contact information for CEL Technology Ltd. There are separate details for Support, Sales and Feedback.

### Support

For product support, we have a ticketing system available online which allows you to track the progress of your support request. Please sign up for an account and submit a ticket at:

 [robox.freshdesk.com](https://robox.freshdesk.com)

### Sales

For sales of accessories and consumables you can contact:

 [uksales@cel-robox.com](mailto:uksales@cel-robox.com)

Or visit our website at:

 [www.cel-robox.com](http://www.cel-robox.com)

### Feedback

Please send all general feedback on Robox® to:

 [feedback@cel-robox.com](mailto:feedback@cel-robox.com)

### Distributor Contact Details

If you purchased your Robox® from an authorised CEL reseller - please find their contact details below:

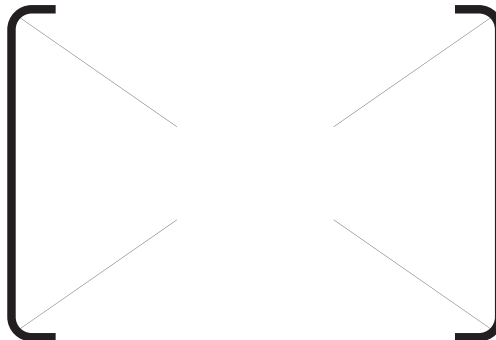

Please direct all support and sales enquiries here in the first instance.



RBX01-ACC-UM