

FIBRE WASHER

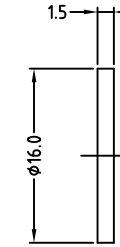

NUT OPTIONS

PLASTIC NUT

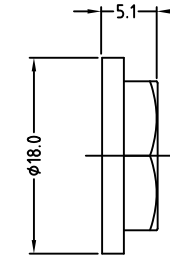

METAL NUT

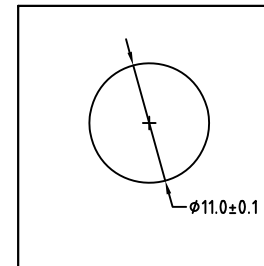
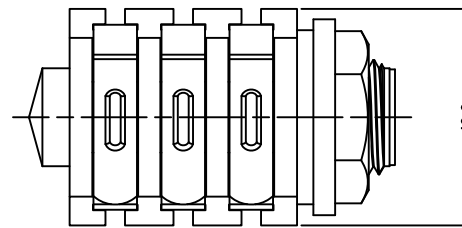
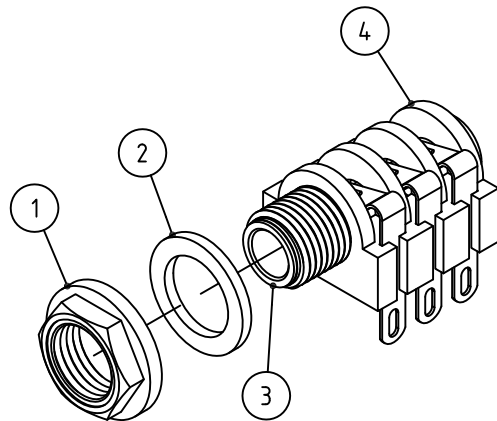
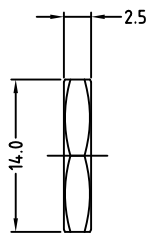

PANEL CUTOUT

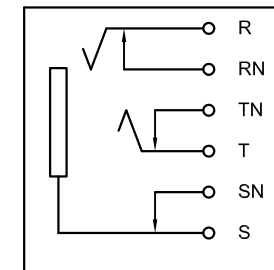

SCHEMATIC

ITEM	DESCRIPTION
1	METAL/PLASTIC NUT
2	FIBRE WASHER
3	METAL TUBE INSERT
4	CONNECTOR ASSEMBLY

PART No.	CATALOG No.	DESCRIPTION
55010293-000	ACJS-MHS	METAL NUT
55010293-001	ACJS-PHS	PLASTIC NUT

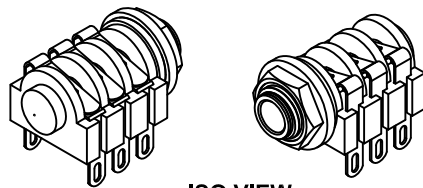

ISO VIEW

UNLESS OTHERWISE SPECIFIED TOLERANCE TO BE

LINEAR	ANGULAR
X ± 0.5	X° ± 1°
X,X ± 0.1	X°X' ± 30'
X,XX ± 0.05	X°X'X" ± 15'

THIS DOCUMENT IS THE PROPERTY OF AMPHENOL AUSTRALIA PTY. LTD. NO PART THEREOF MAY BE REPRODUCED AND USED WITHOUT THE PRIOR WRITTEN CONSENT OF THE OWNER

CAD FILE: 55010293000111 DRN: L.V DATE: 27-02-04

BREAK ALL SHARP EDGES AND REMOVE ALL BURRS

MATL: REFER TO COMPONENT

CKD: M.N.H DATE: 13-01-06

DO NOT SCALE

FINISH: REFER TO COMPONENT

APP'D: P.M DATE: 13-01-06

DIMENSIONS IN MILLIMETRES

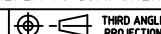

SCALE: 2:1 UOS

PART No: REFER TO TABLE

REV.	CHANGE PART VARIATION NUMBER IN TABLE UPDATE DRAWING TO CURRENT PART	L.V	07-07-04	8293
0	FIRST ISSUE	L.V	27-02-04	----
	CHANGE DETAILS	BY	DATE	CHG/No

TITLE: **ACJS-MHS/ACJS-PHS 1/4" STEREO JACK CUSTOMER DRAWING**

Amphenol
Amphenol Australia Pty.Ltd, 2 Freeways Blvd, Keysborough, Vic3173

DRAWING NO. 55010293-000-1 SHEET 1 OF 1