

PLEASE CHECK WWW.MOLEX.COM FOR LATEST PART INFORMATION

Part Number: [52559-1252](#)
Status: **Active**
Overview: FFC-FPC (SMT)
Description: Easy-On™ Type FFC/FPC Connector, Vertical, Surface Mount, ZIF, 12 Circuits, Gold (Au) Plating, High Barrier Packaging

Documents:

3D Model	Application Specification AS-52559-001 (PDF)
Drawing (PDF)	Packaging Specification SPK-52559-003 (PDF)
Product Specification PS-52559-013 (PDF)	RoHS Certificate of Compliance (PDF)

Agency Certification

UL E29179

General

Product Family	FFC/FPC Connectors
Series	52559
Overview	FFC-FPC (SMT)
Product Name	Easy-On™
UPC	822348533886

Physical

Circuits (Loaded)	12
Contact Position	N/A
Durability (mating cycles max)	20
Entry Angle	Vertical
Flammability	94V-0
Mated Height	3.90mm
Material - Metal	Phosphor Bronze
Material - Plating Mating	Gold
Material - Plating Termination	Tin
Material - Resin	Nylon
Net Weight	192.610/mg
Number of Rows	1
Orientation	Vertical
PCB Locator	No
PCB Retention	Yes
Packaging Type	Embossed Tape on Reel
Pitch - Mating Interface	0.50mm
Polarized to PCB	No
Stackable	No
Temperature Range - Operating	-40°C to +85°C
Termination Interface: Style	Surface Mount
Wire/Cable Type	FFC/FPC

Electrical

Current - Maximum per Contact	0.5A
Voltage - Maximum	50V AC (RMS)/DC

Material Info

Reference - Drawing Numbers

Application Specification	AS-52559-001
Packaging Specification	SPK-52559-003
Product Specification	PS-52559-013, RPS-52559-062, RPS-52559-064, RPS-52559-065, RPS-52559-068, RPS-52559-070,

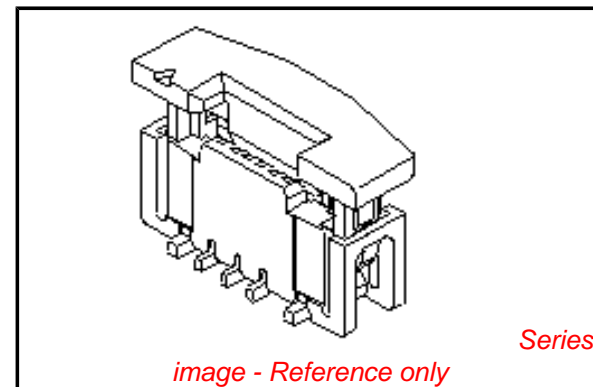

EU RoHS

ELV and RoHS Compliant
REACH SVHC Contains SVHC: No
Low-Halogen Status Not Low-Halogen

China RoHS



Need more information on product environmental compliance?

Email productcompliance@molex.com
 For a multiple part number RoHS Certificate of Compliance, [click here](#)

Please visit the [Contact Us](#) section for any non-product compliance questions.

Search Parts in this Series

[52559Series](#)

Mates With

http://www.molex.com/product/premoflex_ffc-fpc.html>Molex Premo-Flex FFC. Be sure to match like plating

Sales Drawing

RPS-52559-072, RPS-52559-074, RPS-52559-086,
RPS-52559-087, RPS-52559-089, RPS-52559-092
SD-52559-048, SD-52559-049

This document was generated on 02/02/2015

PLEASE CHECK WWW.MOLEX.COM FOR LATEST PART INFORMATION