

Mod. G7540 - Fittings Series 7000 - Automation

Product code: G7540 16

Datasheet creation date: 12/12/2025 08:33

Check the most updated document online [click here](#)



■ TECHNICAL DATA

Mod.	G7540 16
------	----------

Mod. G7540 - Fittings Series 7000 - Automation

Product code: G7540 16

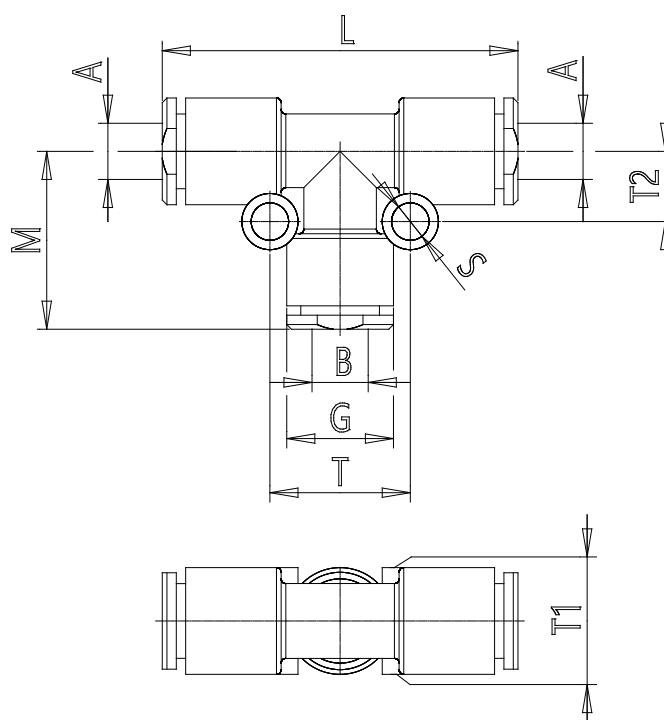

DIMENSIONS

A (mm)	16
B (mm)	16
G (mm)	27.0
L (mm)	76
M (mm)	38.0
S (mm)	0
T (mm)	0.0
T1 (mm)	0.0
T2 (mm)	0.0
Weight (g)	58