

Lighted Pushbutton Switch

A3C

Cylindrical 12-dia. Series with Superb Operability, High Visibility, and Compact Housing

- Three models of pushbutton units (round, square, and rectangular), two types of light-emitting elements (LED and lamp), and two types of switch units (switching general-purpose and microcurrent/voltage loads) available.
- Models that can be used as an indicator also available.
- Requires only 20 mm mounting depth
- Efficiency in wiring improved by terminals arranged on the same surface.
- All LEDs, lamps, lenses, and legends replaceable without tools
- UL (E41515) and CSA (LR45258-31) approved

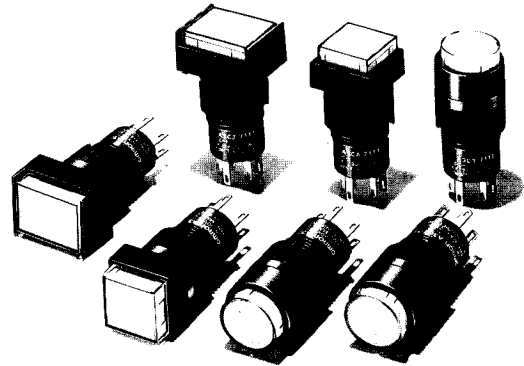

Ordering Information

Lighted Type

When placing your order, specify the individual component part model numbers of the pushbutton unit, LED, lamp, and switch unit, as listed in the ordering tables below.

Pushbutton Unit

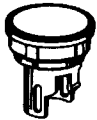

A3C□-500□

LED/Lamp

LED



A3B-0□□□*

Incandescent lamp



A3B-0□□□*

* The same model number is used.

Switch Unit



A3C□-7□□□
M2C□-7□□□**

** Model number unique for indicator unit

Non-lighted Type

When placing your order, specify the model numbers of the pushbutton and switch units.

Pushbutton Unit





A3C□-501□

Switch Unit



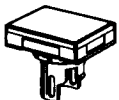

A3C□□-7□□□

**Lighted Pushbutton Unit
LED**

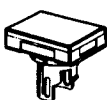
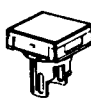

Button color	Rectangular	Square	Round
			
Red	A3CJ-500R	A3CA-500R	A3CT-500R
Yellow	A3CJ-500Y	A3CA-500Y	A3CT-500Y
Green	A3CJ-500GY	A3CA-500GY	A3CT-500GY
White	A3CJ-500W	A3CA-500W	A3CT-500W

Note: With the exception of green, all pushbutton units can be used with either LED or incandescent lamps. Since the hue of green changes with an incandescent light source, use the green LED light source listed elsewhere.

Non-lighted Type

Button color	Rectangular	Square	Round
			
Red	A3CJ-500R	A3CA-500R	A3CT-500R
Yellow	A3CJ-500Y	A3CA-500Y	A3CT-500Y
Green	A3CJ-500G	A3CA-500G	A3CT-500G
White	A3CJ-500W	A3CA-500W	A3CT-500W
Blue	A3CJ-500A	A3CA-500A	A3CT-500A
Black	A3CJ-500B	A3CA-500B	A3CT-500B

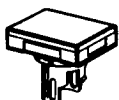
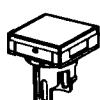
Incandescent Lamp

Button color	Rectangular	Square	Round
			
Red	A3CJ-500R	A3CA-500R	A3CT-500R
Yellow	A3CJ-500Y	A3CA-500Y	A3CT-500Y
Green	A3CJ-500G	A3CA-500G	A3CT-500G
White	A3CJ-500W	A3CA-500W	A3CT-500W
Blue	A3CJ-500A	A3CA-500A	A3CT-500A

Indicator (Same as A3B)



LED

Color	Rated voltage		
	5 VDC	12 VDC	24 VDC
Red	A3B-005R	A3B-012R	A3B-024R
Yellow	A3B-005Y	A3B-012Y	A3B-024Y
Green	A3B-005G	A3B-012G	A3B-024G
White	A3B-005W	A3B-012W	A3B-024W

Incandescent Lamp

Rated voltage	6 VDC	14 VDC	28 VDC
Model	A3B-006	A3B-014	A3B-028

Switch Unit

Configuration	Contact	Switch action	Terminal	Degree of protection: IP00		
				Rectangular	Square	Round
General purpose	SPST-NO+ SPST-NC	Momentary	Solder			
				A3CJ-7011	A3CA-7011	A3CT-7011
Alternate		A3CJ-7021	A3CA-7021	A3CT-7021		
		Micro-load	Momentary	Solder	A3CJ-7111	A3CA-7111
PCB	A3CJ-7112				A3CA-7112	A3CT-7112
Alternate	Solder		A3CJ-7121	A3CA-7121	A3CT-7121	
			PCB	A3CJ-7122	A3CA-7122	A3CT-7122
For indication only (no switch)			Solder	M2CJ-7001	M2CA-7001	M2CT-7001
				PCB	M2CJ-7002	M2CA-7002

Specifications

Contact Ratings

Model	Item	
	AC resistive load	DC resistive load
General-purpose load	0.5 A, 250 VAC 1 A, 125 VAC	1 A, 30 VDC
Micro current/voltage load (see note)	0.1 A, 125 VAC	0.1 A, 30 VDC

Note: The minimum permissible load is 1 mA, 5 VDC.

LED Ratings

Rated voltage	Rated current	Operating voltage
5 VDC	30 mA	5 VDC±5%
12 VDC	15 mA	12 VDC±5%
24 VDC	10 mA	24 VDC±5%

Lamp Ratings

Rated voltage	Rated current	Operating voltage
6 V	60 mA	5 V
14 V	40 mA	12 V
28 V	24 mA	24 V

Characteristics

Operating frequency	Mechanical: Momentary-action type: 120 operations per minute max. Alternate-action type: 60 operations per minute max. Electrical: 20 operations per minute max.
Insulation resistance	100 MΩ min. (at 500 VDC)
Dielectric strength	1,000 VAC, 50/60 Hz for 1 minute between terminals of same polarity 2,000 VAC, 50/60 Hz for 1 minute between terminals of different polarity and also between each terminal and ground Vibration Mechanical/malfunction durability: 10 to 55 Hz, 1.5 mm double amplitude
Shock	Mechanical durability: 500 m/s ² (approx. 50 G) Malfunction durability: 150 m/s ² (approx. 15 G)
Ambient temperature	Operating: -10°C to 55°C
Humidity	35 to 85% RH
Life expectancy	Mechanical: Momentary-action type: 1,000,000 operations min. Alternate-action type: 100,000 operations min. Electrical: 100,000 operations min.
Weight	Approx. 5 g (see note)

Note: The weight indicated here applies to the lighted type (SPST-NO+SPST-NC).

Operating Characteristics

OF max.	250 g
RF min.	30 g
TT	3.5±0.5 mm
LTA min.	0.5 mm
PT max.	2.5 mm

Applicable Load Range

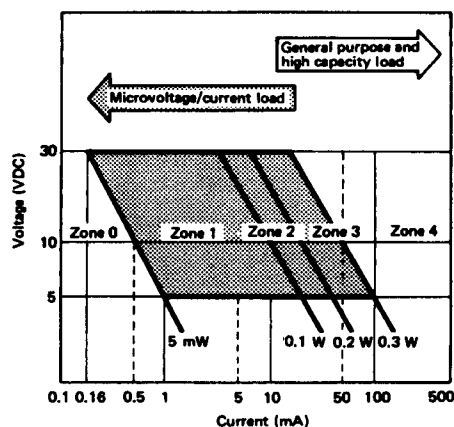

NOTE: The load range shown above is applicable only during the standard conditions.

Approved by Standards

UL (File No. E41515)
CSA (File No. LR45258-31)

Rating

General-purpose Type

1 A, 125 VAC
0.5 A, 250 VAC
1 A, 30 VDC

Microcurrent/Voltage Load

0.1 A, 125 VAC
0.1 A, 30 VDC

Dimensions

The following dimensions apply to the switch unit with SPST-NO+SPST-NC contact configuration, with solder terminals.

Rectangular A3CJ

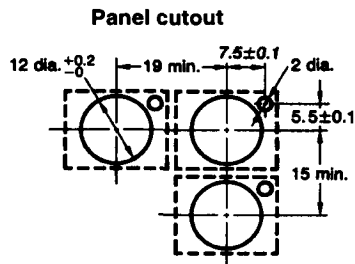
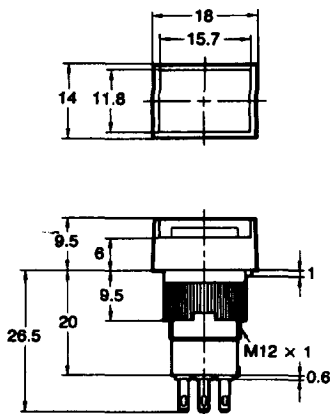
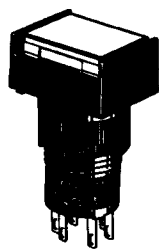

Note: Recommended panel thickness is 1.0 to 3.2 mm.

Square A3CA

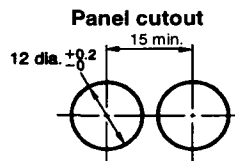
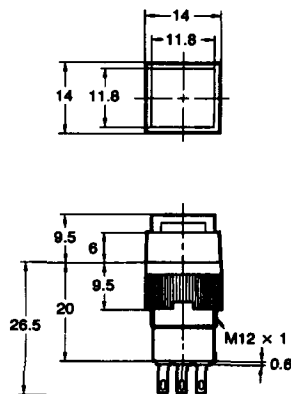
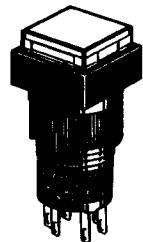

Note: Recommended panel thickness is 1.0 to 3.2 mm.

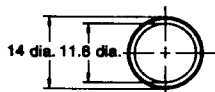

Round A3CT

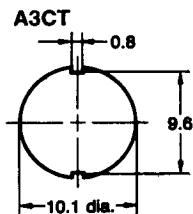
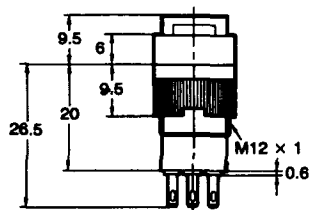

Legend Plate A3CJ

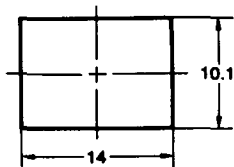

A3CA

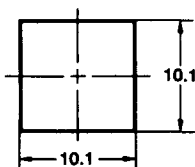

A3CT

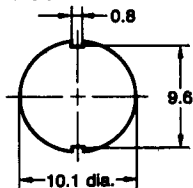





- Note:**
1. The thickness is 0.8 mm.
 2. Since the legend plate is made of polycarbonate, use alcohol-based paints such as melanin, phthalic acid, or acryl paint when marking the legend.

Terminals/Connections

Terminal	Type	
	SPST-NO+SPST-NC	For indication
Solder terminal	<p>Lighted type, non-lighted type</p> <p>Terminal hole (bottom view)</p>	<p>Indicator</p> <p>Terminal hole (bottom view)</p>
	<p>Lighted type, non-lighted type</p> <p>Mounting hole (bottom view)</p>	<p>Indicator</p> <p>Mounting hole (bottom view)</p>

Accessories (Order Separately)

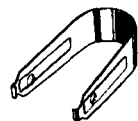
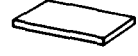
Name	Shape	Classification	Model	Remarks
Socket		Wire-wrap terminal	A3B-4101	Cannot be used with insulation cover.
		PCB terminal	A3C-4102	
		Solder terminal	A3C-4103	
Insulation Cover		---	A3C-3002	Cannot be used with socket.
Switch Guard		Rectangular	A3CJ-5050	Cannot be used with seal cover.
Dust Cover		For all shapes	A3CJ-5060	Cannot be used with seal cover.
Tightening Tool		---	A3C-3004	Useful for mounting switch units one after another. Do not over-tighten.
Extractor		---	A3PJ-5080	Cannot be used with seal cover.
Legend Plate		Rectangular	A3CJ-5201	One legend plate is supplied per standard switch unit.
		Square	A3CA-5201	
		Round	A3CT-5201	

Dimensions with Socket

Wire-wrap Terminal

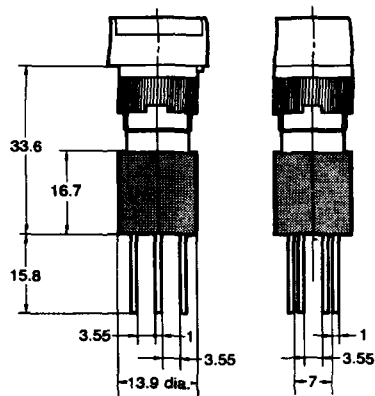

PCB Terminal

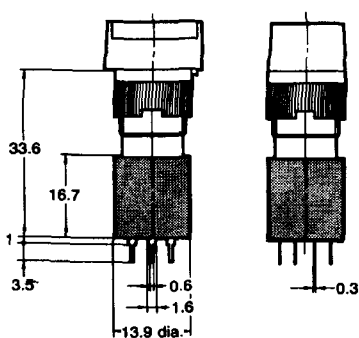

Solder Terminal

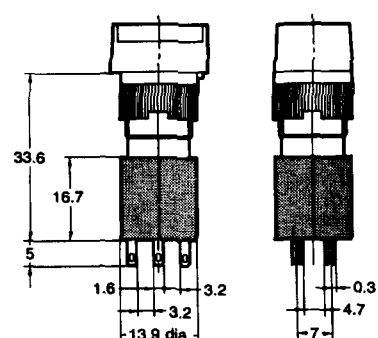

Terminal Hole

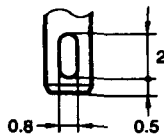

Mounting Hole (Bottom View)

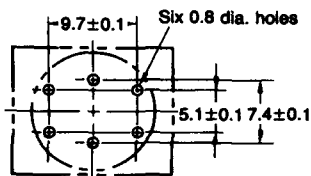

Dimensions with Switch Guard

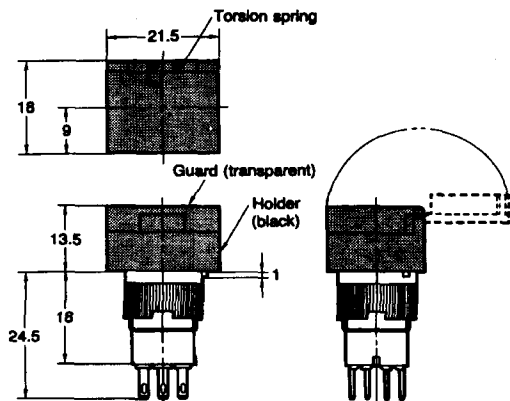

Panel Cutout (Top View)

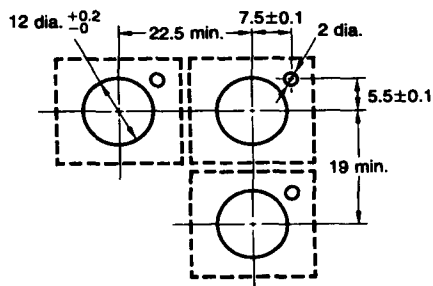

Dimensions with Insulation Cover

The following dimensions apply to the rectangular pushbutton unit. After mounting the switch unit on a panel, and after tightening the mounting nut, insert the lead wires into the hole on the insulation cover before wiring. Align the insulation cover so that the cylindrical portion of the insulation cover will face the switch unit. This means that the lead wires will be inserted from the barrier side of the insulation cover. After wiring has been completed, slide the insulation cover over the switch unit.

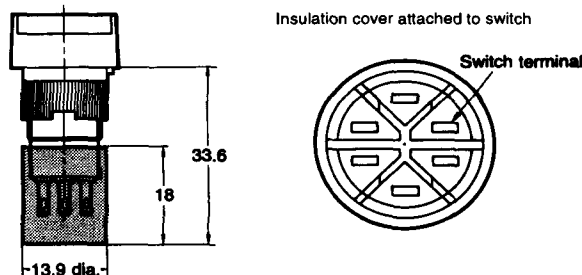

Assembly/Disassembly

Mounting and Replacing Pushbutton Unit

Mounting directions for the LED/lamp and pushbutton unit
The OMRON Pushbutton Unit doubles the roles in which a pushbutton switch is normally used. The pushbutton unit may be inserted one of two ways:

1. For operation as a lighted pushbutton switch, fit the LED/lamp so that its guide projection is inserted into the wider opening in the receptacle of the pushbutton unit.

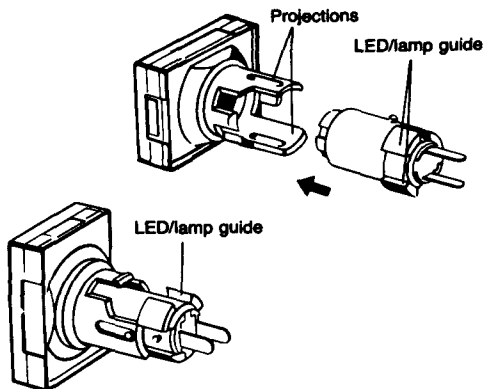

2. For operation as an indicator unit, insert the LED/lamp guide projection into the narrower opening in the indicator unit's receptacle. Push the projection of the LED/lamp in the groove of the pushbutton unit so that the LED/lamp is firmly inserted into the pushbutton unit of the indicator unit.

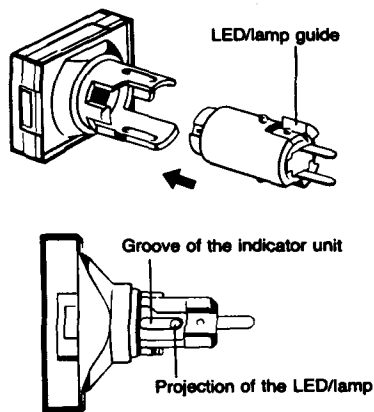

Note: The inserting direction of the LED/lamp for the pushbutton unit is the opposite of that for the indicator unit. Pay attention to the mounting direction of the legend plate.

Removing the Pushbutton Unit

With your thumb and forefinger, while holding the recessed portions on both sides, firmly and steadily pull out the top of the pushbutton unit. Pulling out the cap with pliers or a similar tool will damage the cap.

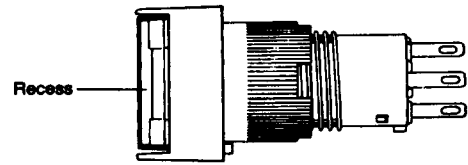

Mounting Switch Unit on Panel

Nut Mounting

- Insert the switch unit from the front of the panel and tighten the mounting nut inserted from the rear of the panel.
- Since a projection exists on the rear portion of the switch unit, if the mounting nut cannot be fitted into position, turn the nut slightly.
- The tightening torque of the mounting nut should be less than 5 kg-cm.
- Solder the terminals after mounting the nut. Otherwise, the terminals, when thickened by solder, may prevent the nut from being screwed down onto the switch unit.

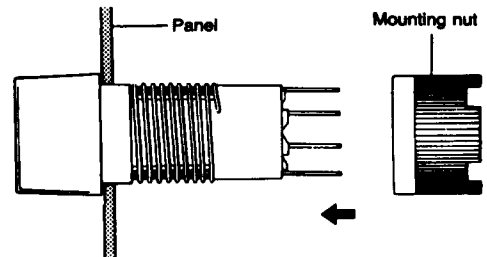

Wiring

- Finish soldering within 5 seconds with a 30 watt soldering iron, or within 3 seconds at a solder temperature of 240°C. For about a minute after soldering, do not apply any force to the switch unit, to avoid deforming the softened plastic switch unit base.
- Use a non-corrosive, resin-based soldering flux.

Construction

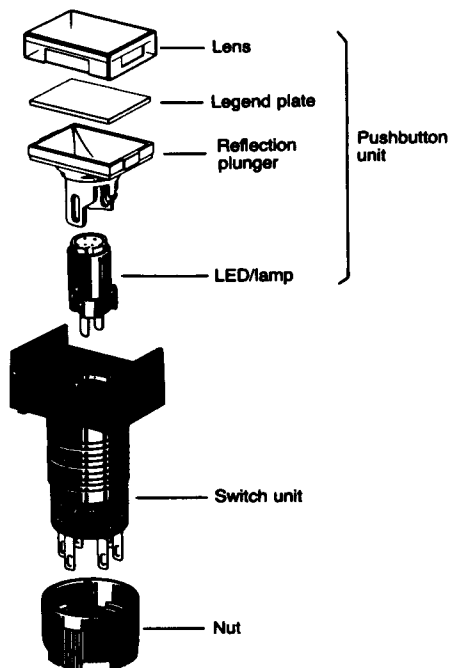

ALL DIMENSIONS SHOWN ARE IN MILLIMETERS.

To convert millimeters into inches, multiply by 0.03937. To convert grams into ounces, multiply by 0.03527.