

Circuit Breaker for Equipment thermal, Threaded neck type, Reset type, Quick connect terminals



Description

- Threaded neck type
- Thermal circuit breaker
- 1-pole
- Reset type
- Positively trip-free release
- Wide current range
- High breaking capacity
- Quick connect terminals 6.3 x 0.8 mm

Standards

- IEC 60934
- UL 1077
- CSA C22.2 235
- GB 17701

Applications

- Power supplies
- Uninterruptible power supply
- Power tools
- Household appliances

Weblinks

[pdf-datasheet](#), [html-datasheet](#), [General Product Information](#), [Approvals](#), [CE declaration of conformity](#), [RoHS](#), [CHINA-RoHS](#), [REACH](#), [e-Shop](#), [SCHURTER-Stock-Check](#), [Distributor-Stock-Check](#), [Detailed request for product](#), [Product News](#)

Technical Data

Rated Voltage AC	240/277 V; 50/60 Hz, see approbations
Rated Voltage DC	28 V
Rated current range AC	0.05 - 30 A
Conditional short circuit capacity	IEC: Inc, PC1, AC 240V: 1 kA
Short circuit capacity I _{cn}	at I _n < 7 A/240 VAC : 8 x I _n at I _n ≥ 7 A/240 VAC : 400 A AC/DC 28 V : 400 A
Degree of Protection	from front side IP 40 acc. to IEC 60529
Dielectric Strength	50Hz: 1.5kV Impulse 1.2/50 μs: > 2.5kV
Insulation resistance	500VDC > 100 MΩ
Endurance typical	2 x I _r : 3000 switching cycles
Endurance minimum	Reset type AC : 2 x I _r , cos φ 0.6 : DC : 2 x I _r , L/R = 2 - 3 ms : 50 switching cycles

Overload	IEC: min. 40 trips @ 6 x I _r , cos φ 0.6 UL / CSA: min. 50 trips @ 1.5 x I _r , cos φ 0.75
Ambient temperature	-5 °C to 60 °C
Vibration Resistance	± 1.5 mm @ 10 - 60 Hz acc. to IEC 60068-2-6, test Fc 10 G @ 60 - 500 Hz acc. to IEC 60068-2-6, test Fc
Shock Resistance	100 G / 6ms acc. to IEC 60068-2-27, test Ea
Tripping Type	Thermal
Actuation type	Reset type
Weight	ca. 10g

Dimension

T13-211

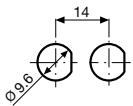
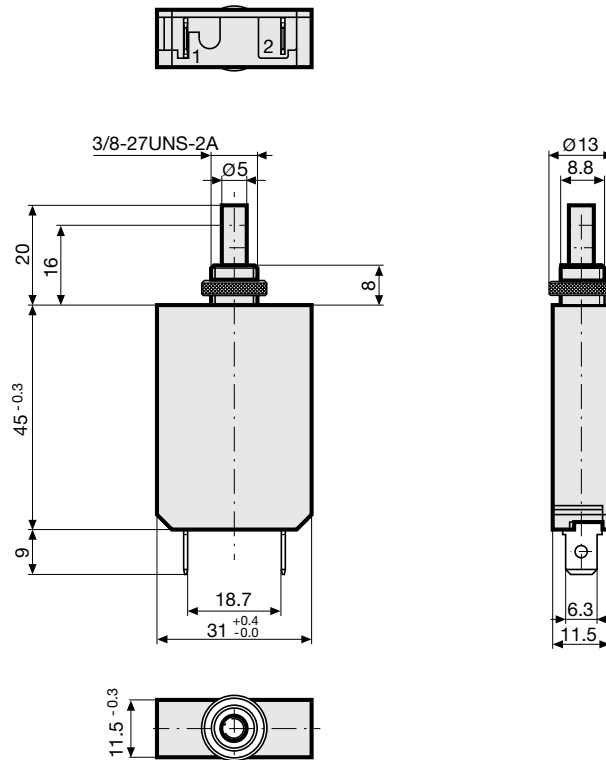



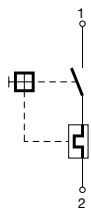

Diagrams

T13-...



Approvals

Approval		Rated current	Rated voltage AC	Rated voltage DC
	UL 1077	0.05...30 A	277 V	28 V
	CSA C22.2 No. 235	0.05...30 A	277 V	28 V
	EN 60934	0.05...30 A	240 V	-
	GB 17701	0.05...30 A	240 V	-

Typical internal resistance

Rated Current [A]	Internal Resistance [Ω]
0.05	376.500
0.50	4.40
1.00	1.10
2.00	0.31
3.00	0.14
4.00	0.068
5.00	0.048
6.00	0.033
8.00	0.026
9.00	0.0125
10.00	0.0125
11.00	0.0085
12.00	0.0085
13.00	0.0085
14.00	0.007
15.00	0.007
16.00	0.007
17.00	0.0047
18.00	0.0047
19.00	0.0047
20.00	0.004
21.00	0.0035
22.00	0.003
23.00	0.003
24.00	0.003
25.00	0.003
26.00	0.0022
27.00	0.002
28.00	0.002
29.00	0.002
30.00	0.002

Time-Current-Curves

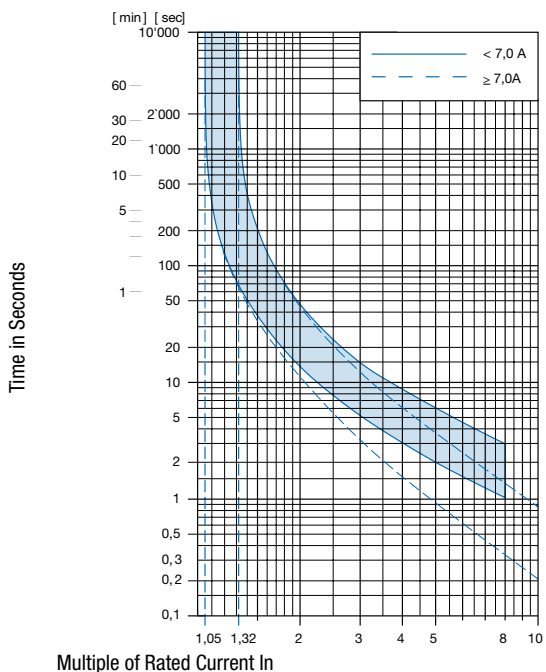

Reference Temperature +23°

Effect of ambient temperature

The units are calibrated for an ambient temperature of +23°C. To determine the rated current for a lower or higher ambient temperature, use a correction factor (typical value) from the table below:

Ambient temperature [°C]	Correction factor
-5	0.88
0	0.90
10	0.95
23	1.00
30	1.05
40	1.10
50	1.18
60	1.26

Example: Rated current = 5 A; Environmental temperature = 40 °C; --> Correction factor = 1.1; Resulting current = 5.5 A --> Fount to next higher rated current: 6 A

Config. Code

T13 - 1 2 3 B - 1.23

The characters are placeholders for the correspondingly keys of selections from the key tables.

T13 - **1** 2 3 B - 1.23 = Mounting

T13 - 1 2 **3** B - 1.23 = Terminal

Mounting	Configuration key
Threaded neck type with knurled nut	2

Terminal	Configuration key
Quick connect terminal 6.3x0.8mm	1

T13 - 1 **2** 3 B - 1.23 = Actuation type

T13 - 1 2 3 **B** - 1.23 = Setting indication

Actuation type	Configuration key
Reset type	1

Setting indication	Configuration key
Setting indication	R

T13 - 1 2 3 B - 1.23 = Rated current

Rated current	Configuration key
0.05 A	0.05
0.1 A	0.1
0.15 A	0.15
0.2 A	0.2
0.3 A	0.3
0.4 A	0.4
0.5 A	0.5
0.6 A	0.6
0.7 A	0.7
0.8 A	0.8
0.9 A	0.9
1.0	1
1.1 A	1.1
1.2 A	1.2
1.3 A	1.3
1.4 A	1.4
1.5 A	1.5
1.6 A	1.6
1.7 A	1.7
1.8 A	1.8
1.9 A	1.9
2.0 A	2
2.1 A	2.1
2.3 A	2.3
2.5 A	2.5
2.8 A	2.8
3.0 A	3
3.3 A	3.3

Other rated currents on request

Rated current	Configuration key
3.5 A	3.5
4.0 A	4
4.5 A	4.5
5.0 A	5
5.5 A	5.5
6.0	6
6.5 A	6.5
7.0 A	7
7.5 A	7.5
8.0 A	8
8.5 A	8.5
9.0 A	9
9.5 A	9.5
10.0 A	10
11.0 A	11
12.0 A	12
13.0 A	13
14.0 A	14
15.0 A	15
16.0 A	16
17.0 A	17
18.0 A	18
19.0 A	19
20.0 A	20
22.0 A	22
25.0 A	25
28.0 A	28
30.0 A	30

Other rated currents on request

Variants

Rated current	Setting indication	Config. Code	Order Number
15.0 A		T13-211-15	4411.0007
20.0 A		T13-211-20	4411.0010
30.0 A		T13-211-30	4411.0017
18.0 A		T13-211-18	4411.0019
25.0 A		T13-211-25	4411.0073
30.0 A	●	T13-211R-30	4411.0221

Most Popular.

Availability for all products can be searched real-time:<http://www.schurter.com/en/Stock-Check/Stock-Check-SCHURTER>

Packaging Unit 1 Pcs

Accessories

Description



T-Linie Zubehör
Accessories to T-Line