

Miniature Door Switch

D3D

Unique Mechanism Allows Switching of Both Micro Loads and Power Loads

- Choose from plunger or lever as the actuator type.
- Low operating force of 2 N max.
- Quick-connection terminals for easier wiring.
- High contact reliability ensured with gold crossbar contacts.

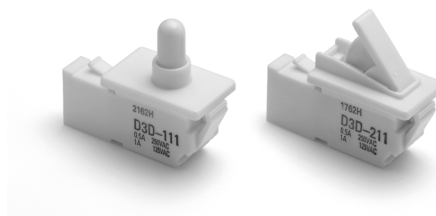



Ordering Information

■ Model Number Legend

D3D-□□1
1 2

1. **Actuator**
 - 1: Plunger
 - 2: Lever
2. **Contact Form**
 - 1: SPDT
 - 2: SPST-NC
 - 3: SPST-NO

■ List of Models

Actuator	Contact form		
	SPDT	SPST-NC	SPST-NO
Plunger 	D3D-111	D3D-121	D3D-131
Lever 	D3D-211	D3D-221	D3D-231

Specifications

■ Ratings

Rated voltage	Resistive load
125 VAC	1 A
250 VAC	0.5 A

Note The ratings values apply under the following test conditions.

Ambient temperature: 20±2°C

Ambient humidity: 65±5%

Operating frequency: 20 operations/min

■ Characteristics

Operating speed	7.5 to 500 mm/s
Operating frequency	Mechanical: 120 operations/min max. Electrical: 30 operations/min max.
Insulation resistance	100 MΩ min. (at 500 VDC)
Contact resistance (initial value)	100 mΩ max.
Dielectric strength	1,000 VAC, 50/60 Hz for 1 min between terminals of the same polarity 1,500 VAC, 50/60 Hz for 1 min between current-carrying metal parts and ground, and between each terminal and non-current-carrying metal parts
Vibration resistance	Malfunction: 10 to 55 Hz, 1.5-mm double amplitude
Shock resistance (see note 2)	Destruction: 490 m/s ² max. Malfunction: 300 m/s ² max.
Durability (see note 3)	Mechanical: 300,000 operations min. (60 operations/min) Electrical: 50,000 operations min. (20 operations/min)
Degree of protection	IP40
Degree of protection against electric shock	D3D-1 models (plunger models): Class II D3D-2 models (lever models): Class 0
Proof tracking index (PTI)	600
Ambient operating temperature	-30°C to 60°C (with no icing)
Ambient operating humidity	85% max.
Weight	Approx. 4 g

- Note:**
- The data given above are initial values.
 - The contacts do not open or close for more than 1 ms.
 - Consult your OMRON sales representative for details on test conditions.

■ Approved Standards

Consult your OMRON sales representative for specific models with standard approvals.

UL1054 (File No. E41515) /

CSA C22.2 No. 55 (UL approval)

	D3D
125 VAC	1 A
250 VAC	0.5 A

EN61058-1 (File No. 40005053, VDE approval)

	D3D
125 VAC	1 A
250 VAC	0.5 A

Testing conditions: 5E4 (50,000 operations), T55 (0°C to 55°C)

■ Contact Specifications

Contact	Specification	Crossbar
	Material	Gold alloy
Minimum applicable load (see note)	1 mA at 5 VDC	

Note For more information on the minimum applicable load, refer to *Using Micro Loads* on page 269.

■ Contact Form

SPDT

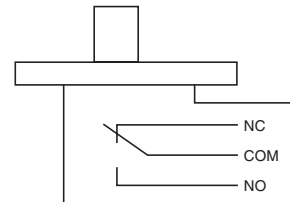

SPST-NC

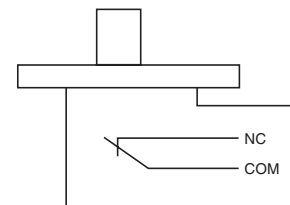

SPST-NO

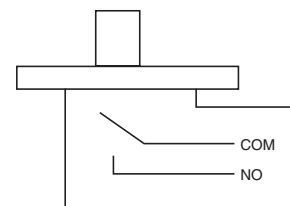

Dimensions

■ Dimensions and Operating Characteristics

- Note:**
1. All units are in millimeters unless otherwise indicated.
 2. Unless otherwise specified, a tolerance of ± 0.4 mm applies to all dimensions.
 3. The operating characteristics are for operation in direction A (indicated by the arrow).

Plunger Models

D3D-111
D3D-121
D3D-131

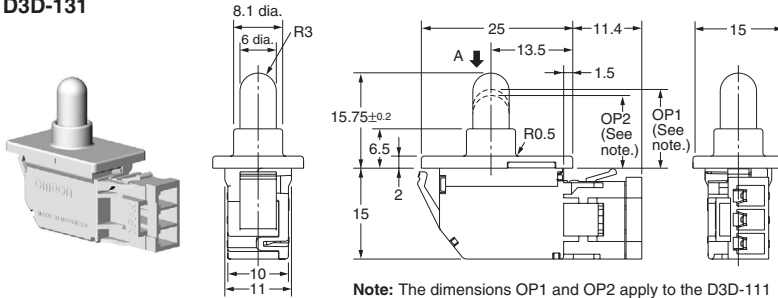

Note: The dimensions OP1 and OP2 apply to the D3D-111 only. The D3D-121 and D3D-131 are SPST-NC and SPST-NO respectively and so therefore have only one corresponding dimension here (OP).

Type Model	Plunger model		
	D3D-111	D3D-121	D3D-131
OF max.	2.0 N {204 gf}		
TTF max.	3.5 N {357 gf}		
TT	9.0 mm (reference value)		
OP min.	OP1 (NC-OFF) 13 mm	13 mm	12 mm
	OP2 (NO-ON) 12 mm		

Lever Models

D3D-211
D3D-221
D3D-231

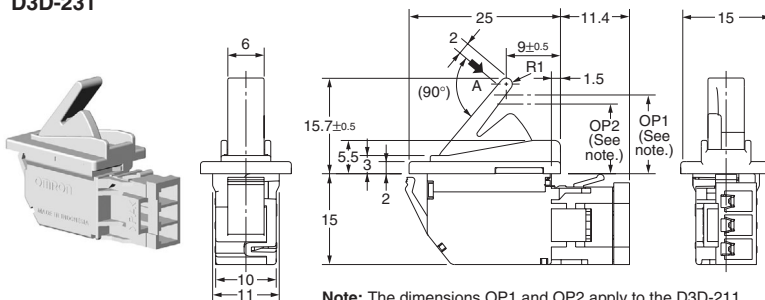

Note: The dimensions OP1 and OP2 apply to the D3D-211 only. The D3D-221 and D3D-231 are SPST-NC and SPST-NO respectively and so therefore have only one corresponding dimension here (OP).

Type Model	Lever model		
	D3D-211	D3D-221	D3D-231
OF max.	2.0 N {204 gf}		
TTF max.	3.5 N {357 gf}		
TT	9.7 mm (reference value)		
OP min.	OP1 (NC-OFF) 13 mm	13 mm	11.5 mm
	OP2 (NO-ON) 11.5 mm		

■ Mounting Panel Cutout Dimensions

Note All units are in millimeters unless otherwise indicated.

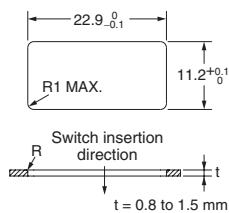

■ Connectors

The terminals connect to JST's HL Connector.

The HL Connector consists of the following components.

Contact: SSF-21T-P1.4

Housing: HLP-03V

OMRON does not sell the HL Connector. Contact the following.

J.S.T. Manufacturing Co., Ltd. (Japan)

Tel: (81)6-6968-6855

Fax: (81)6-6964-2085

J.S.T. (U.K.) Ltd. (United Kingdom)

Tel: (44)1986-874131

Fax: (44)1986-874276

J.S.T. Corporation (U.S.A.)

Tel: (1)847-473-1957

Fax: (1)847-473-1373

J.S.T. (H.K.) Co. Ltd. (Hong Kong)

Tel: (852)24137979

Fax: (852)24111193

Precautions

■ Cautions

Handling

Do not expose the Switch to shocks, such as by dropping it. Doing so may damage or deform the Switch.

Do not apply lubrication to the sliding parts, such as pushbuttons or actuators. Doing so may result in faulty operation or contact failure.

In order to ensure stable contact force for NO contacts, use an operating stroke of at least 5 mm.

■ Correct Use

Mounting

This product does not have a waterproof or drip-proof construction. Ensure that water does not enter the Switch interior. In particular, do not use the Switch in locations where water may be spilt or flow over the Switch. Doing so may result in deterioration of the insulation.

Wiring

Do not use the Switch with a large force applied to the connector or lead wire. Doing so may result in rattling or contact failure.

Storage Environment

Storing the Switch in a plastic bag will help prevent discoloration due to sulfuration of the (silver-plated) terminals.

Do not use the Switch in locations subject to harmful gases or to high temperatures or humidity levels. Depending on the location, it is recommended that Switches are inspected between 3 and 6 months after the date of manufacturer.

Using Micro Loads

Even when using the Switch within the operating range, if there are inrush currents or surges, it may decrease the durability of the Switch. If necessary, insert a contact protection circuit.

ALL DIMENSIONS SHOWN ARE IN MILLIMETERS.

To convert millimeters into inches, multiply by 0.03937. To convert grams into ounces, multiply by 0.03527.