

# HIGH PRECISION THERMISTOR

## AT THERMISTOR

The AT thermistor is a high-precision thermal sensing device featuring an extremely small B-value tolerance and resistance. When used as a temperature gauge, the AT thermistor requires no adjustment between the control circuit and the sensor. This insures a temperature precision of  $\pm 0.3^{\circ}\text{C}$ . Temperature indicators and control instruments are now available for use with the thermistor.

### Part number

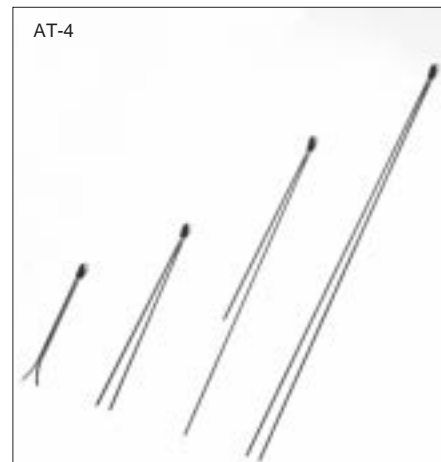
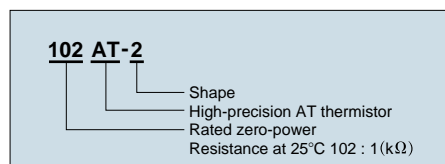

### Dimensions

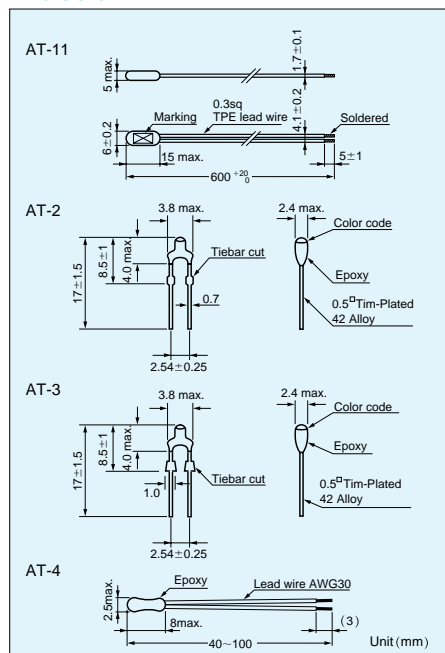

### Resistance tolerance

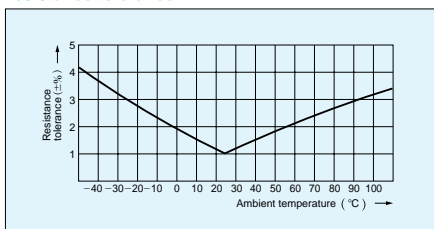

### Interchange precision

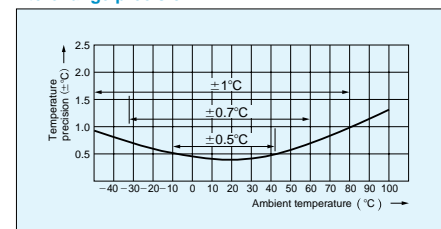

### Specifications

Part No	R <sub>25</sub> <sup>1</sup>	B value <sup>2</sup>	Dissipation factor (mW/°C)	Thermal time constant (s) <sup>3</sup>	Rated power at 25°C (mW)	Operating temp. range(°C)	Color code
102AT-2	1.0kΩ ± 1%	3100K ± 1%	2	15	10	-50~90	Black
202AT-2	2.0kΩ ± 1%	3182K ± 1%	2	15	10	-50~90	Red
502AT-2	5.0kΩ ± 1%	3324K ± 1%	2	15	10	-50~110	Yellow
103AT-2	10.0kΩ ± 1%	3435K ± 1%	2	15	10	-50~110	White
203AT-2	20.0kΩ ± 1%	4013K ± 1%	2	15	10	-50~110	None
503AT-2	50.0kΩ ± 3%	4060K ± 1%	2	15	10	-50~110	None
103AT-3	10.0kΩ ± 1%	3435K ± 1%	2	15	10	-50~110	White
103AT-4	10.0kΩ ± 1%	3435K ± 1%	2	10	10	-30~90	None
102AT-11	1.0kΩ ± 1%	3100K ± 1%	3	75	15	-50~90	None
202AT-11	2.0kΩ ± 1%	3182K ± 1%	3	75	15	-50~90	None
502AT-11	5.0kΩ ± 1%	3324K ± 1%	3	75	15	-50~105	None
103AT-11	10.0kΩ ± 1%	3435K ± 1%	3	75	15	-50~105	None

<sup>1</sup> R<sub>25</sub>: Rated zero-power resistance value at 25°C.

<sup>2</sup> B value: determined by rated zero-power resistance at 25°C and 85°C.

<sup>3</sup> Time when thermistor temperature reaches 63.2% of the temperature difference. The value is measured in the air.

### Resistance - Temperature

Temperature (°C)	Type						Temperature (°C)	Type					
	102AT	202AT	502AT	103AT	203AT	503AT		102AT	202AT	502AT	103AT	203AT	503AT
-50	24.46	55.66	154.6	329.5	1253	3168	35	0.7229	1.424	3.508	6.940	13.06	32.48
-45	18.68	42.17	116.5	247.7	890.5	2257	40	0.6189	1.211	2.961	5.827	10.65	26.43
-40	14.43	32.34	88.91	188.5	642.0	1632	45	0.5316	1.033	2.509	4.911	8.716	21.59
-35	11.23	24.96	68.19	144.1	465.8	1186	50	0.4587	0.8854	2.137	4.160	7.181	17.75
-30	8.834	19.48	52.87	111.3	342.5	872.8	55	0.3967	0.7620	1.826	3.536	5.941	14.64
-25	6.998	15.29	41.21	86.43	253.6	646.3	60	0.3446	0.6587	1.567	3.020	4.943	12.15
-20	5.594	12.11	32.44	67.77	190.0	484.3	65	0.3000	0.5713	1.350	2.588	4.127	10.13
-15	4.501	9.655	25.66	53.41	143.2	364.6	70	0.2622	0.4975	1.168	2.228	3.464	8.482
-10	3.651	7.763	20.48	42.47	109.1	277.5	75	0.2285	0.4343	1.014	1.924	2.916	7.129
-5	2.979	6.277	16.43	33.90	83.75	212.3	80	0.1999	0.3807	0.8835	1.668	2.468	6.022
0	2.449	5.114	13.29	27.28	64.88	164.0	85	0.1751	0.3346	0.7722	1.451	2.096	5.105
5	2.024	4.188	10.80	22.05	50.53	127.5	90	0.1536	0.2949	0.6771	1.266	1.788	4.345
10	1.684	3.454	8.840	17.96	39.71	99.99	95			0.5961	1.108	1.530	3.712
15	1.408	2.862	7.267	14.69	31.36	78.77	100			0.5265	0.9731	1.315	3.185
20	1.184	2.387	6.013	12.09	24.96	62.56	105			0.4654	0.8572	1.134	2.741
25	1.000	2.000	5.000	10.00	20.00	50.00	110			0.4128	0.7576	0.9807	2.369
30	0.8486	1.684	4.179	8.313	16.12	40.20							

Unit(kΩ)

## Voltage - Current Characteristics

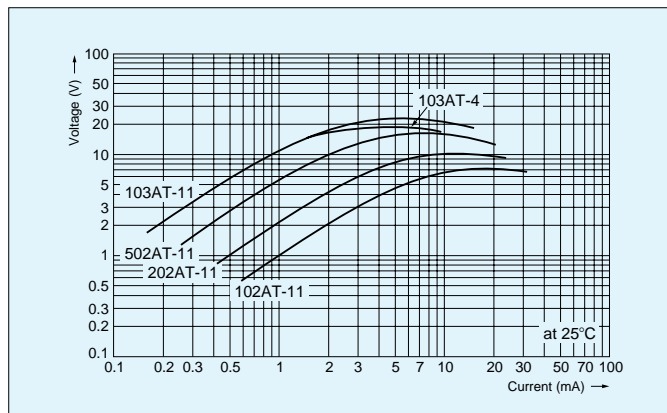
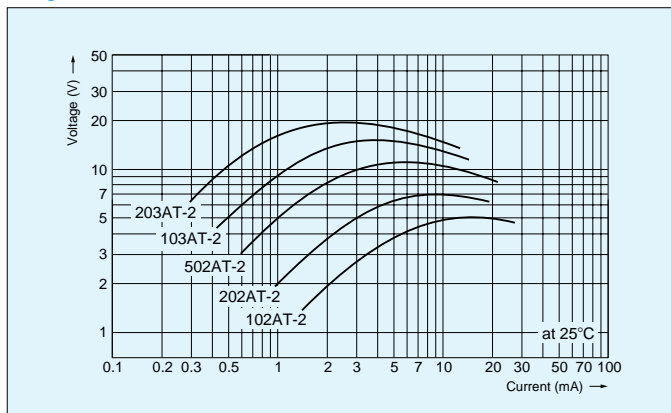

## Notes

- To bend the lead wires, secure the lead wires at least 3mm away from the base of the epoxy coat by a cutting pliers and etc. and then bend the lead wire side, but not the epoxy coat side.
- Eliminate any event and/or circumstance where more than 2N pressure is applied to the lead wires in the direction shown by the arrow or where the lead is spread wide more than  $\pm 0.3\text{mm}$  from the original position.

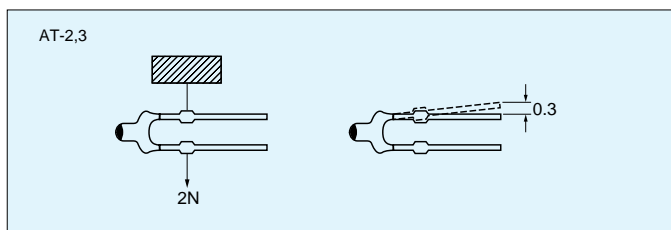

- The soldering time (the duration of the time) should be less than 7 seconds when a soldering iron with 50W power at 340°C is applied to the portion of the lead wire at least 5mm away from the thermistor body. (at the bottom of the epoxy resin)