

Transfer or duplication of this document as well as the utilisation or communication of its content are not permitted unless express consent is granted. Violations give rise to claims for damages. All rights reserved in case of patent, utility model or design patent registrations.

Weitergabe sowie Vervielfältigung dieses Dokuments, Verwertung und Mitteilung seines Inhalts sind verboten, soweit nicht ausdrücklich gestattet. Zuwiderhandlungen verpflichten zu Schadenersatz. Alle Rechte für den Fall der Patent-, Gebrauchsmuster- oder Designeintragung vorbehalten.

position 1

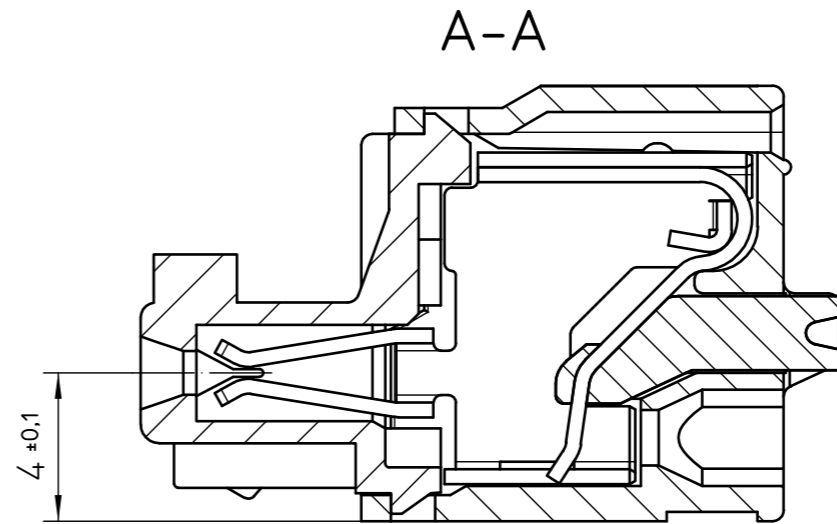
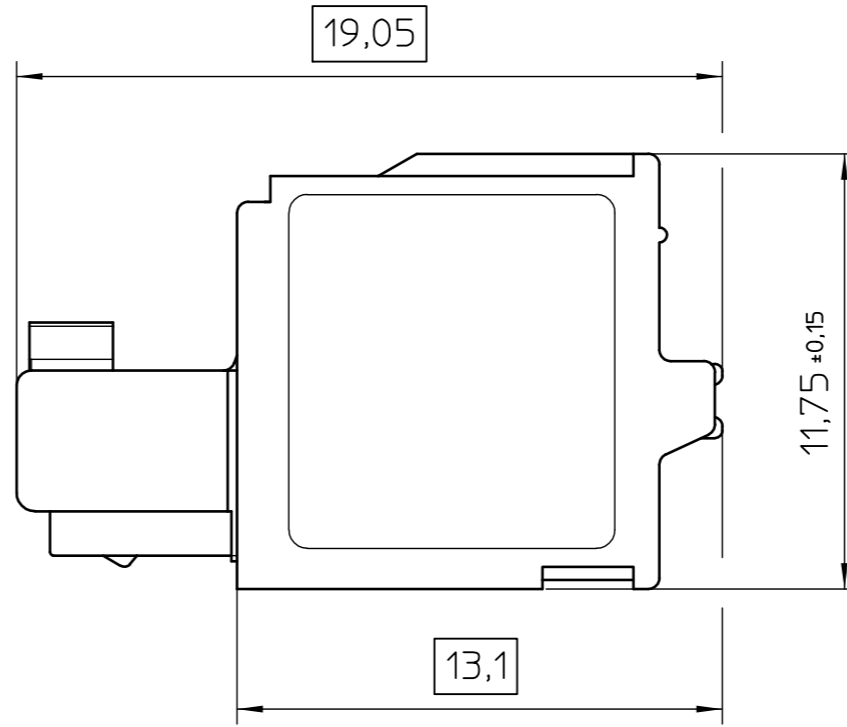
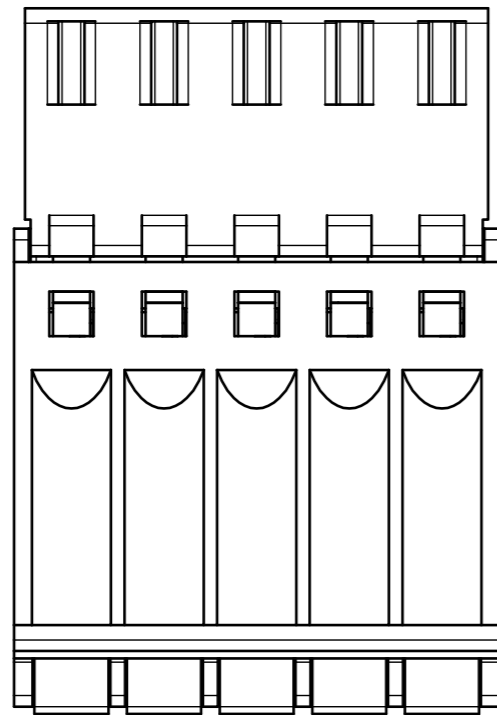
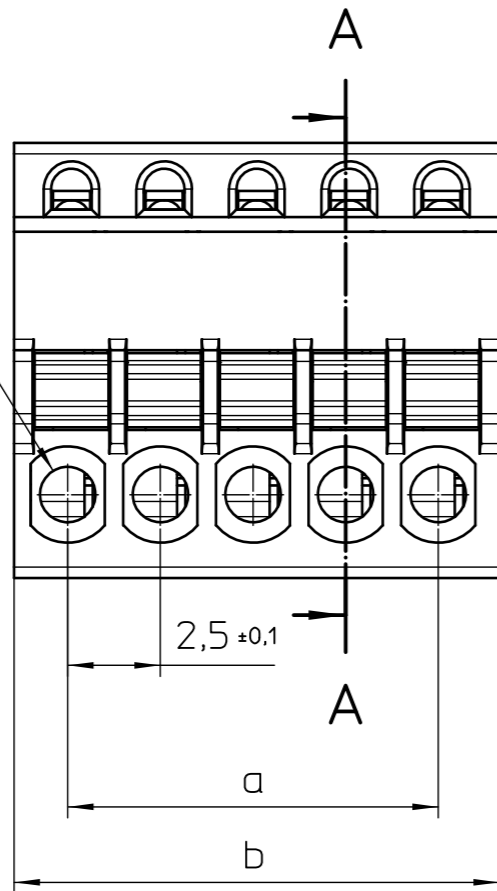

pos.	dim. a	dim. b
2	2,50 ± 0,10	5,60 ± 0,10
3	5,00 ± 0,10	8,10 ± 0,15
4	7,50 ± 0,15	10,60 ± 0,15
5	10,00 ± 0,15	13,10 ± 0,15
6	12,50 ± 0,15	15,60 ± 0,15
7	15,00 ± 0,15	18,10 ± 0,20
8	17,50 ± 0,15	20,60 ± 0,20
9	20,00 ± 0,20	23,10 ± 0,20
10	22,50 ± 0,20	25,60 ± 0,20
11	25,00 ± 0,20	28,10 ± 0,20
12	27,50 ± 0,20	30,60 ± 0,20

	document-No. / RI	date	scale
	00848030 / 01	03.06.2015	5:1
	ident.-No.	document-type	
	1881354	TECDC 2D-PRODUCTFAMILY	
page 1 of 1	description		
FK-MC 0,5/ 5-ST-2,5			