



### Main

Range of product	Harmony K
Product or component type	Complete cam switch
Component name	K2
[Ith] conventional free air thermal current	20 A
Product mounting	Front mounting
Fixing mode	Multifixing
Cam switch head type	With front plate 45 x 45 mm
Type of operator	Black handle, length = 35 mm
Rotary handle padlocking	Without
Presentation of legend	With metallic legend, 2 - 0 - 1 black marking
Cam switch function	Changeover switch
Return	Without
Off position	With Off position
Poles description	4P
Switching positions	Left: 0° - 315° Right: 0° - 45°
IP degree of protection	IP40 conforming to IEC 529 IP40 conforming to NF C 20-010





### Complementary

Switching angle	45 °
[Ui] rated insulation voltage	690 V (pollution degree 3) conforming to IEC 60947-1
[Ithe] conventional enclosed thermal current	16 A
Electrical durability	200000 Cycles AC-23 200000 Cycles AC-3 600000 Cycles AC-15 600000 cycles AC-21
Maximum operating rate	2.5 Cyc/Mn AC-21 2.5 Cyc/Mn AC-23 2.5 Cyc/Mn AC-3 8.333 cyc/mn AC-15
Short-circuit current	10000 A
Short-circuit protection	20 A cartridge fuse, type gG
[Uimp] rated impulse withstand voltage	4 kV in isolating function 6 kV conforming to IEC 947-1
Contact operation	Slow-break
Positive opening	With
Electrical connection	Captive screw clamp terminals flexible, clamping capacity: 2 x 1.5 mm <sup>2</sup> Captive screw clamp terminals solid, clamping capacity: 1 x 2.5 mm <sup>2</sup>
Mechanical durability	1000000 cycles
CAD overall width	45 mm
CAD overall height	45 mm
CAD overall depth	107 mm
Net weight	0.195 kg

## Environment

Standards	EN 60947-3 for power circuit EN 60947-5-1 for control circuit IEC 60947-3 for power circuit IEC 60947-5-1 for control circuit CENELEC EN 50013
Product certifications	CSA 240 V 3 hp 3 phases 2 pole(s) UL 240 V 0.33 hp 1 phase 2 pole(s) CSA 240 V 1 hp 1 phase UL 240 V 1 hp 3 phases
Protective treatment	TC
Ambient air temperature for operation	-25...55 °C
Ambient air temperature for storage	-40...70 °C
Shock resistance	30 gn conforming to IEC 68-2-27
Vibration resistance	5 gn conforming to IEC 68-2-6 (f = 10...150 Hz)
Electrical shock protection class	Class II conforming to IEC 536 Class II conforming to NF C 20-030

## Offer Sustainability

Sustainable offer status	Green Premium product
REACH Regulation	 <a href="#">REACH Declaration</a>
REACH free of SVHC	Yes
EU RoHS Directive	Pro-active compliance (Product out of EU RoHS legal scope)  <a href="#">EU RoHS Declaration</a>
Toxic heavy metal free	Yes
Mercury free	Yes
RoHS exemption information	 <a href="#">Yes</a>
China RoHS Regulation	 <a href="#">China RoHS Declaration</a>
Environmental Disclosure	 <a href="#">Product Environmental Profile</a>
WEEE	The product must be disposed on European Union markets following specific waste collection and never end up in rubbish bins

## Contractual warranty

Warranty	18 months
----------	-----------

---

Operating Head and Body

---

Front Mounting "Multi-Fixing"

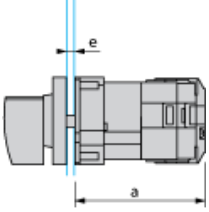

- a 83 mm/3.27 in.
- e support panel thickness 1 mm to 6 mm./0.039 in. to 0.24 in.

Link Positions (Factory Mounted)

Diagram for 1 to 4-pole Switches

Select the number of poles according to the product characteristics.

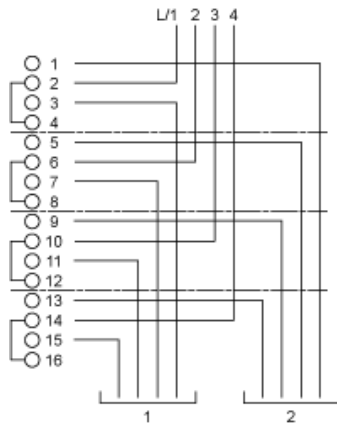

Marking

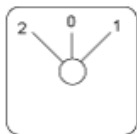

Angular Position of Switch

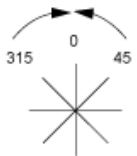

Switching Program

Diagram for 1 to 4-pole Switches

Select the number of poles according to the product characteristics.

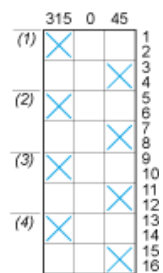



- (1) 1-pole
- (2) 2-pole
- (3) 3-pole
- (4) 4-pole

## Convention Used for Switching Program Representation

---

 Contact closed

 Contact closed in 2 positions and maintained between the 2 positions

 Sealed assembly for auto-maintain control

 Overlapping contacts

 Spring return position: for a switching angle of 90°, spring return is over 30° after the last position (for a maximum of 3 simultaneous contacts).

Example:

