

RevNo	Revision note	Date	Signature	Checked
-------	---------------	------	-----------	---------

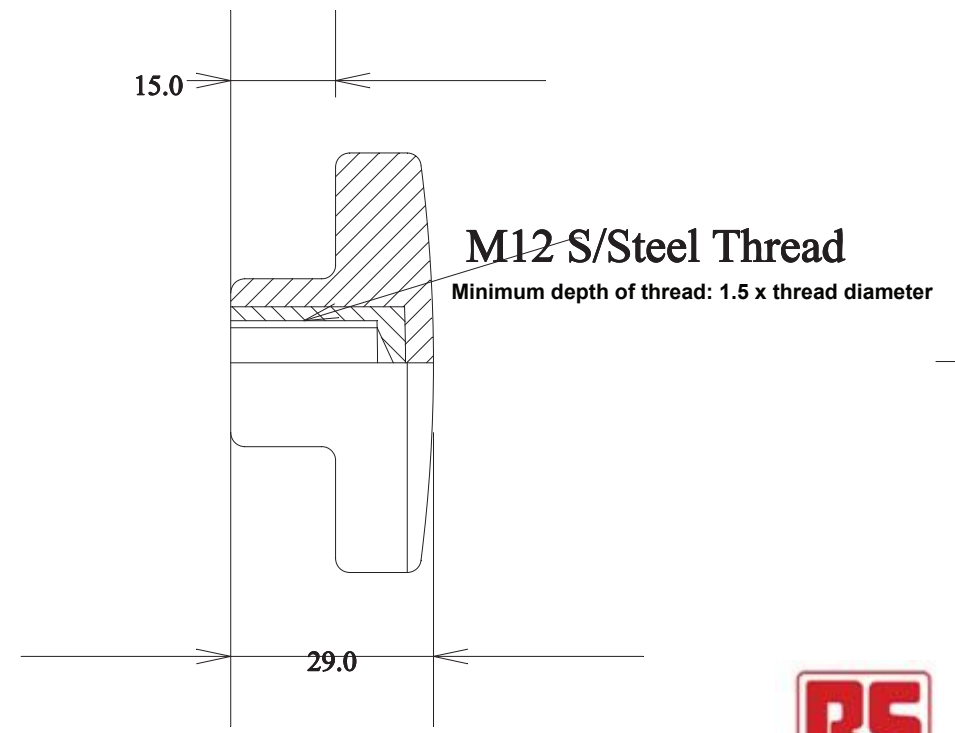
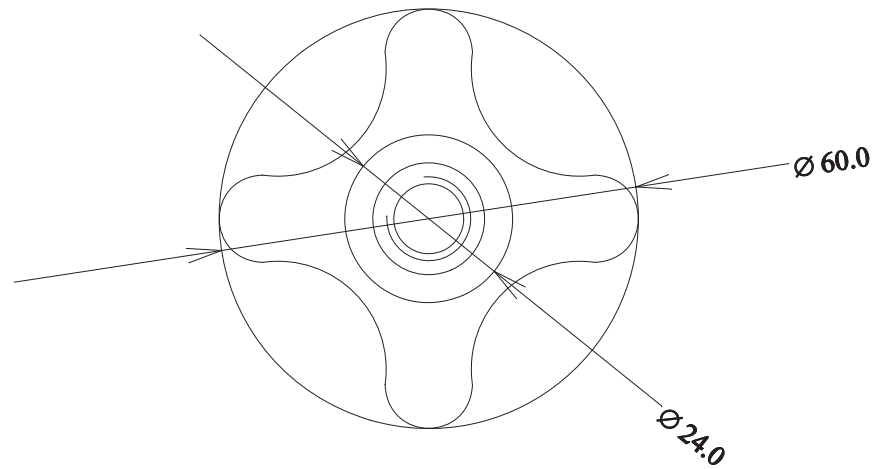

Itemref	Quantity	Title Star Knob - Polypropylene REV.2	Article No./Reference		
Designed by	Checked by	Approved by - date	Filename	Date 06 / 04 / 2010	Scale
			RS 7027752		
			Edition 1	Sheet 1/1	