

HENGSTLER

Timing tasks ...
get everything from one source
NEW: LED timer „tico 742“



Electronic
Timer family
„tico“

tico 740 – 742

Multi-function timer family



tico 740



tico 741



tico 742: **NEW!**

General information

With its new multi-function timer family "tico", HENGSTLER offers a wide and versatile product range that leaves nothing to be desired. It is suitable for all applications from basic analog to high-performance units with special features - a most convincing solution regarding functionality, design, quality and price-performance ratio.

Variety of applications

Timing tasks are found in almost every industry and in the medical and food sector. Listed below are just a few of the numerous applications in which tico can be

Packaging
Electronics
Plastics processing
Food + beverages
Medicine
Chemical industry
Other industries

Dwell time, gas evacuation and tunnel time, seal sequencing
Solder time, UV curing, Ultrasonic welding
Mold time
Cook time, Cure time/pasteurization time, filling processes
Radiation time, stimulation-current therapy
Mixing processes
Screen printing, tire balancing, car washes, textile, printing presses, sewage plants, grain dryers, irrigation systems, photographic development, welding equipment, chemical laundries, paint spray booths, pump control systems.

Common features

- DIN housing 48 x 48 mm, DIN-rail or panel mountable
- Inputs for Start and Reset
- Low weight of only 100 grams
- Universal power supply 24-240 VAC 50/60 Hz and 24 VDC
tico 742: 85-264 VAC, 50-60 Hz and 24 VAC/DC
- Standard socket connector 11-pin
- IP 65, CE, UL/CSA
- Accessories: 11-pin socket for DIN-rail mounting

Technical data – General

Current supply	Universal power supply 24-240 VAC 50/60 Hz and 24 VDC, tico 742: 85-264 VAC, 50-60 Hz or 24 VAC/DC power consumption < 10 VA
Inputs	Start input Contact or NPN; Contact requirements < 1 kΩ Reset input NPN requirements: VCEO = 20 V (min.), VCE(S) = 1 V (max.), IC = 50 mA (min.), ICBO = 0.5 μA (max.) Inhibit input
Outputs	Timed contact Changeover contact 5 A, 120/240 VAC or 30 VDC; Instantaneous contact Operate time approx. 15 ms 100 000 cycles at max. load, 10 million cycles at min. load
Mechanical	Mounting Front panel or DIN-rail with socket Front panel mounting Cutout 45 (+0.3) mm x 45 (+0.3) mm
Environmental	Protection Front panel IP 65 Temperature Operating temperature: 0-50 °C; storage temperature - 40 to + 90 °C
General	DIN EN 61010 VDE 0411 Part 1; protection according to class II, contamination level 2; overvoltage category II

tico 740, tico 741, tico 742

tico 740, tico 741, tico 742 Basic modes of operation

The following gives an overview of all possible operating modes.

(A) On-delay

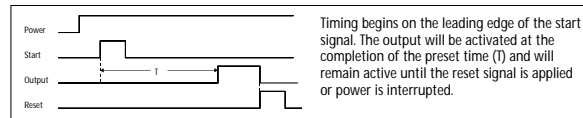

(B) Off-delay

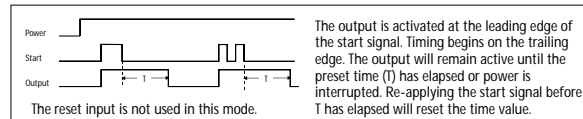

(C) Interval

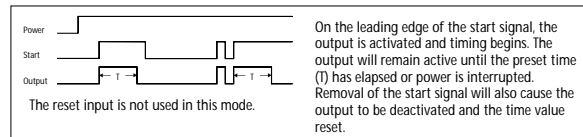

(D) Repeat cycle On or OFF starting

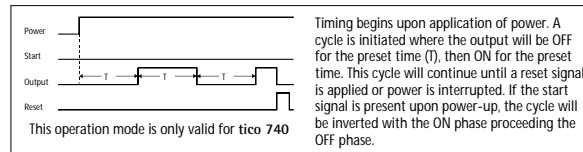

(E) On-delay/interval

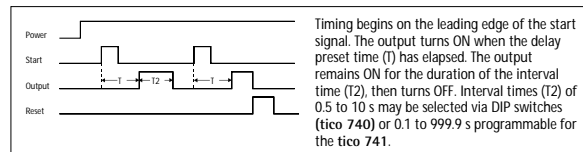

(F) Repeat Cycle with start signal

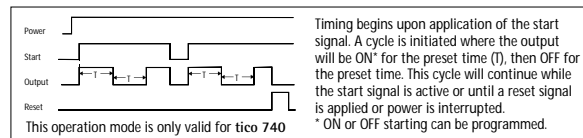

(G) Einzel-Wischimpuls/ Interval 2 (= One-shot)

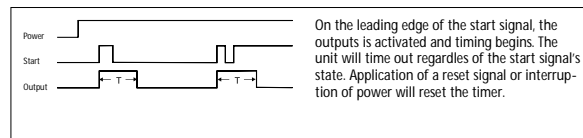

tico 740

Analog-Timer



tico 740

- Dial for fast and convenient setting of values
- Programming via DIP switches and range switches
- Suitable for front-panel or DIN-rail mounting with socket
- LED signals timing process
- Inputs for Start and Reset
- Universal voltage supply 24-240 VAC 50/60 Hz and 24 VDC
- Standard socket 11-pin
- Protection IP 65
- UL, CE and CSA-approved

Connection diagram

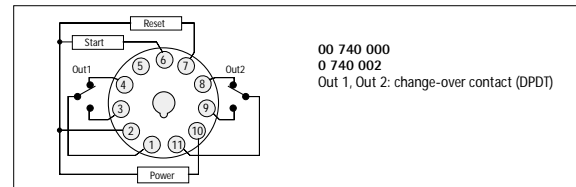

Technical data

Specific
(See page 2 for general technical data)

Dial	Dial with scale from 0 to 10 with 50 graduation marks, left or right limit stopper total locking of the dial by means of the locking ring (accessory)
Time ranges	6 time ranges: 1 s, 10 s, 1 min., 10 min., 1 hour, 10 hours, adjustable by means of a screwdriver at the bottom of the housing (right stop)
Operating modes	Adjustable via DIP switches
Accuracy	Setting accuracy $\pm 5\%$ Reproducibility $\pm 0,5\%$
Dimensions	DIN 48 x 48 mm
Mounting depth	76 mm, or approx. 87 mm with socket

Dimensional drawings

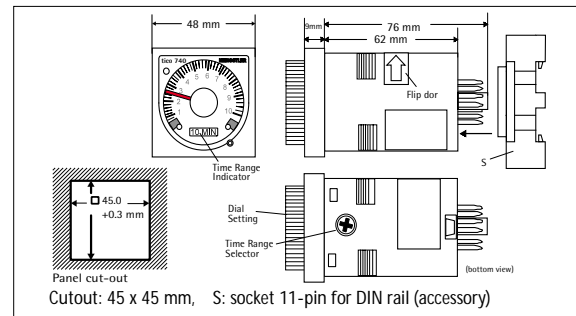

Ordering information

Article-No	Description	Operating modes*
0 740 000	Analog multi-function timer	(A), (B), (C), (D)
0 740 002	Timer On-Delay/Interval	(E)
1 740 100	Accessory: Dial scale + mounting bracket	
1 740 111	Accessory: 11-pin socket	

* see operating modes on page 3 S. 3

Multi-funktion timer, LCD

tico 741



tico 741

- Convenient operation via the keyboard
- High-contrast, 2-line display
- Suitable for front-panel mounting or mounting on DIN-rail (via a socket)
- Resolution up to 0.01 sec.
- Inputs for Start and Reset
- Universal voltage supply 24-240 VAC 50/60 Hz and 24 VDC
- Instantaneous contact version (active with the first start signal)
- Protection IP 65
- UL, CE and CSA-approved

Front Panel Operation

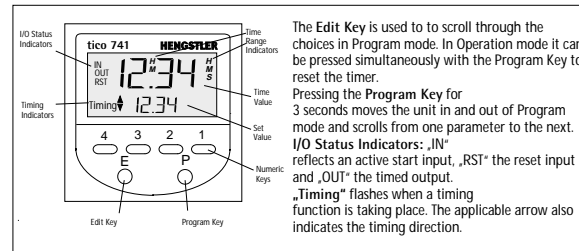

Connection diagram

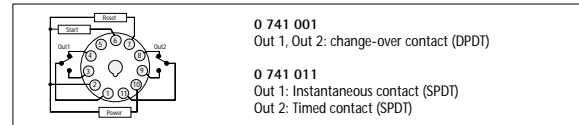

Technical data

Specific
(See page 2 for general technical data)

Display	LCD, 2-line 4 digits per line; indicators for timing, input signal, output status, timing direction, time ranges
Time ranges	5 time ranges: hours, minutes, seconds, hh:mm, mm:ss, up to 9999 hours
Resolution	Programmable from XXXX to XX.XX for hours, minutes, seconds: resolution down to 0.01 s
Accuracy	Reproducibility $\pm 0.03\%$
Dimensions	DIN 48 x 48 mm
Mounting depth	81 mm; with socket: 90 mm
Front panel thickness	max. 10 mm

Dimensional drawing

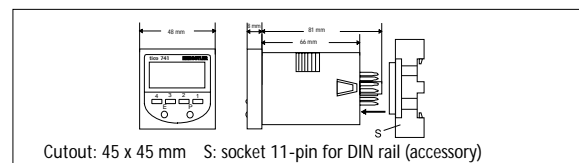

Ordering information

Article No.	Description	Operating modes*
0 741 001	Digital multi-function timer	(A), (B), (C), (E), (F), (G)
0 741 011	Digital timer with instantaneous contact	(A), (B), (C), (E), (F), (G)
1 740 100	Accessory: Locking ring + mounting bracket	
1 740 111	Accessory: 11-pin socket	

* see operating modes on page 3

tico 742 **NEW!**



tico 742 – **NEW!**

Multi-funktion timer (LED)

- Two separate preset modes
- High-contrast, 2-line display (4 digits per line)
- Intuitive programming of all operating modes via the keyboard
- Suitable for front panel mounting or DIN rail mounting (with socket)
- Inputs for Start, Reset and Inhibit
- Resolution 1 ms, 0.01%
- 2 changeover contacts or 2 transistor outputs
- Universal voltage supply 85-264 VAC 50/60 Hz and 24 VAC/DC
- Programmable operating modes and time ranges
- Programmable for up or down counting
- Interference immunity according to IEC 801 Level 3
- Protection IP 65, UL, CE, CSA-approved
- Programmable Power Reset function

This timer family sets new standards in multi-functionality, versatility and price-performance ratio. tico 742 is the only product available on the market which exhibits two separate 4-digit timer preset options, batch counter, %-setting, accumulative counting, edge-triggered line transients, and which can perform the tasks of several instruments simultaneously.

tico 742 is offered in 3 basic versions: high-performance with 17 modes of operation, repeat cycle for separate ON and OFF settings, and standard (LED version of tico 741).

tico 742: High-Performance

- 17 different operating modes can be selected (see overview)
- 2 separate, 4-digit timer preset functions
- Batch counter
- Resolution 1 ms, reproducibility 0.01%
- Inhibit input: interrupts the timing without changing the output status

tico 742: Repeat cycle

- Independent settings of ON/OFF intervals
- Cycle can be entered as a time base and % value
- Programmable for ON or OFF starting
- Batch counter with/without cycle stop
- Inhibit input: interrupts the timing without changing the output status

tico 742: Standard

- Low-cost LED timer
- Functions and programming as described for tico 741

Technical data

Specific

(See page 2 for general technical data)

Display	LED, 2-line, 4 digits per line, indicators for input signals, output status, time ranges
Time ranges	5 ranges: hours, minutes, seconds, hh:mm, mm:ss, up to 9999 hours
Resolution	Programmable from XXXX to X.XXX for hours, minutes, seconds Resolution down to 1 ms
Accuracy	Reproducibility $\pm 0.01\%$
Power supply	85-264 VAC, 50/60 Hz or 24 V AC/DC
Reaction times	4 ms (24 V versions) 21 ms (230 V versions)
Transistor outputs	NPN O.C. 30 V DC, 30 mA max.
Non-volatile memory via	EEPROM
Dimensions	DIN 48 x 48 mm
Mounting depth	81 mm; with socket: 90 mm
Front panel thickness	max. 10 mm

Multi-funktion timer (LED)

tico 742 **NEW!**

Operating

I/O Status Indicators
Illuminates to display when an input or output is active: "IN" for the start input, "O1" and "O2" for the timed outputs.

Preset 2 Indicator
Illuminates to indicate that Preset 2 is being shown on the lower display.

Numeric Keys
Each of the number keys is used to increment the value of the corresponding digit of the preset or parameter value

Edit Key
In Control Mode: With "P" key, resets the display value.
In Program Mode: Scrolls between the applicable choices for the currently displayed parameter.



Primary Display
In Control Mode: Displays the current time value associated with the displayed preset or the batch value (if configured).
In Program Mode: Display the Parameter Description.

Time Range Indicator
Illuminates to show the time base: H for hours, M for minutes, S for seconds. Multiple indicators will be illuminated when the time base is Hours: Minutes or Minutes:Seconds. During timing operation the illuminated LED will flash.

Batch Indicator
Illuminates to indicate that the Batch Count Value and Batch Preset are being displayed.

Set Value
In Control Mode: Displays the settable value used to trigger the timed output(s) and the batch count (if configured).
In Program Mode: Displays the current selection for the chosen parameter.

Program Key
In Control Mode: Depressing the key will scroll the display among the preset and batch displays. Holding the key down for 3 seconds will shift the unit into Program Mode. With the "E" key, resets the displayed value.
In Program Mode: Depressing the key will scroll the display from one parameter to the next. Holding the key down for 3 seconds will shift the unit to Control Mode.

Connection diagram

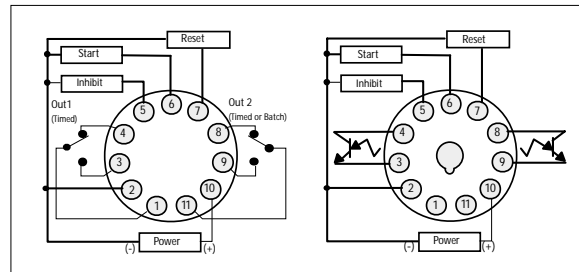

Dimensional drawings

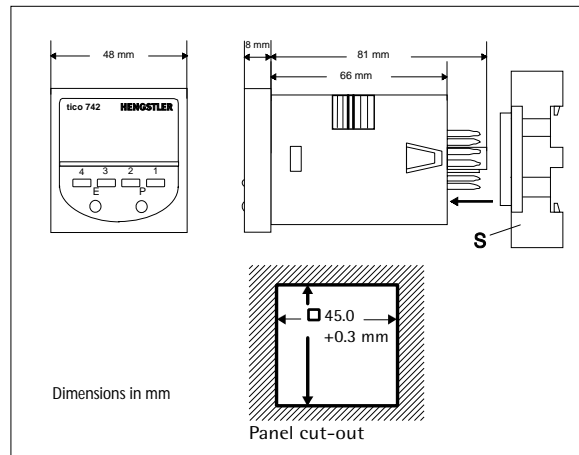

tico 742 **NEW!**

Multi-funktion timer (LED)

A wide range of operating modes for versatile use
(Examples)
See basic modes of operations on page 3

Accumulative - pre-signal

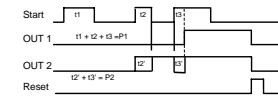

On/Off Delay - Batch

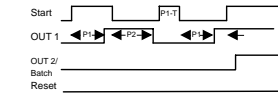

Interval 1 - Sequential

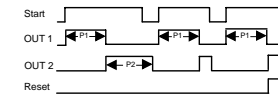

Interval 1 - Batch

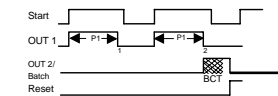

Use of preset 2

Basic mode of operation	Preset 2 (= Out 2)						
	Absolute	Pre-signal	Common Start	Common End	Sequential	Other	Batch
On delay	√	√	√				√
Off delay							√
Interval 1 (*1)			√	√	√		√
Interval 2 (*2)			√	√	√		√
On delay Interval						√	√
Accumulative	√	√	√				√
On/Off delay						√	√

*1 Start signal must be applied

*2 Edge of start signal is sufficient

Ordering information

High Performance

Article No.	Beschreibung
0 742 201	LED Timer, 85-264 VAC, Relay
0 742 202	LED Timer, 24 VAC/DC, Relay
0 742 251	LED Timer, 85-264 VAC, NPN
0 742 252	LED Timer, 24 VAC/DC, NPN

Repeat cycle

0 742 701	LED Timer, 85-264 VAC, Relay
0 742 702	LED Timer, 24 VAC/DC, Relay
0 742 751	LED Timer, 85-264 VAC, NPN
0 742 752	LED Timer, 24 VAC/DC, NPN

Standard

0 742 501	LED Timer, 85-264 VAC, Relay
0 742 502	LED Timer, 24 VAC/DC, Relay

Zubehör

1 740 111	Accessory: 11-pin socket
-----------	--------------------------

All information given in this brochure is solely used to describe technical characteristics, but does not constitute any binding guarantee of such characteristics. Subject to alterations.

HENGSTLER

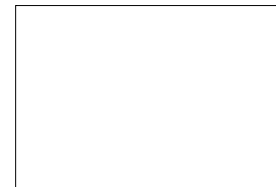

Hengstler GmbH
Postfach 11 51,
D-78550 Aldingen/Germany
House address: Umlandstraße 49
D-78554 Aldingen
Tel. +49-7424-89 0
Fax +49-7424-89 500

Sales:
Tel. +49-7424-89 572 or 89 348
Technical Support:
Tel. +49-7424-89 282
<http://www.hengstler.de>
e-mail: info@hengstler.de



DOC. 1160.00 E

Member of  **DANAHER CORPORATION** U.S.A.

  DQS certified to DIN EN ISO 9001
Reg. No. 1540-01

tico-Timer: 3000 - 1095 - ÖkoDruck - Printed in Germany
Printed on paper of non-pollutative chlorine-free, non-acid production