

FOOT M10 D60 L=82

Article Nr. 21.1882/0

[See the product on the website →](#)

[Download CAD Files →](#)

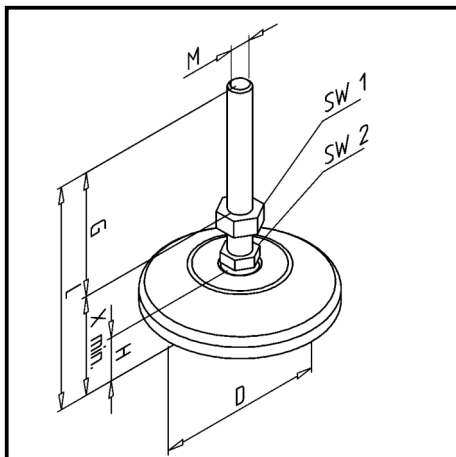
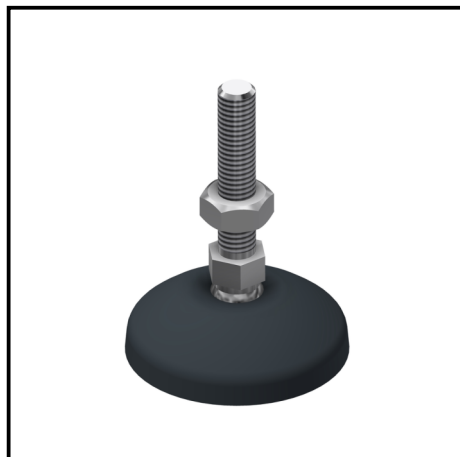

TECHN. DATA / ITEMS SUPPLIED

- Plate PA, grey
- Anti-slip license NBR, black
- Spindle steel, galvanized
- Lock nut steel, galvanized
- Angular compensation up to 15°
- D = 60 mm
- H = 20 mm
- Load capacity max. 1000 kg
- Dimension G = 42 mm
- Dimension X = 40.5 mm
- SW1 = 17 mm
- SW2 = 14 mm
- Dimension L = 82,5 mm
- Weight = 0.088 kg/piece

APPLICATIONS

- Height adjustable constructions of all kinds
- Protective equipment, tables, showcases
- Conveyors, system workstations

ASSEMBLY

- Direct in central drilling of the profiles
- For threads larger than M12, the hinged feet must be mounted in conjunction with the connection plate
- For profiles 45 x 90 und 90 x 90 a base and transport plate is required, if the feet are to be positioned centrally.