

A765, Polymer Aluminum, 220 uF, 20%, 6.3 VDC, -55/+105°C

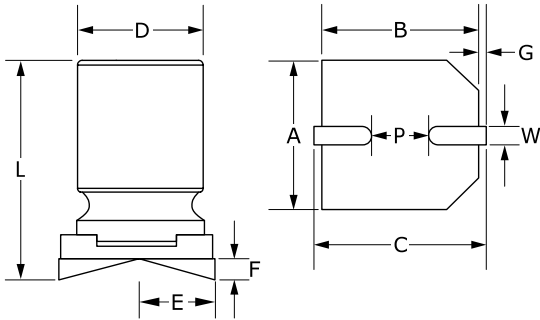

General Information	
Supplier:	KEMET
Series:	A765
Dielectric:	Polymer Aluminum
Style:	SMD Can
Description:	Surface Mount, Polymer Aluminum
RoHS:	Yes
Lead:	V-Chip
AEC-Q200:	No

Dimensions	
D	5mm +/-0.5mm
L	7mm +/-0.3mm
W	0.5 - 0.8mm
F	0.2mm MAX
A	5.3mm +/-0.2mm
B	5.3mm +/-0.2mm
C	6mm +/-0.2mm
E	2.3mm +/-0.2mm
G	0.35mm +/-0.2mm
P	1.4mm +/-0.2mm

Specifications	
Capacitance:	220 uF
Capacitance Tolerance:	20%
Voltage DC:	6.3 VDC, 7.2 VDC (Surge)
Temperature Range:	-55/+105°C
Rated Temperature:	105°C
Life:	2000 Hrs
Resistance:	20 mOhms (100kHz 20C)
Ripple Current:	2700 mAmps (100kHz 105C)
Leakage Current:	300 uA (2min 20°C)
Impedance Ratio at -25C:	1.25
Impedance Ratio at -55C:	1.25
High Temperature Solder:	No

Packaging Specifications	
Packaging:	T&R, 380mm
Packaging Quantity:	1000

Statements of suitability for certain applications are based on our knowledge of typical operating conditions for such applications, but are not intended to constitute - and we specifically disclaim - any warranty concerning suitability for a specific customer application or use. This Information is intended for use only by customers who have the requisite experience and capability to determine the correct products for their application. Any technical advice inferred from this Information or otherwise provided by us with reference to the use of our products is given gratis, and we assume no obligation or liability for the advice given or results obtained.