

## VARIMETER Speed Monitor MK 9055N, MH 9055



### Your Advantage

- Protection of persons, machines and products
- Easy setting
- Universal input, for configuration of different sensors (PNP, NPN, 2-wire, contact, voltage)
- With fast reaction at low speed

### Features

- According to IEC/EN 60 255-1
- Detection of high or low-rpm / stand still (adjustable function)
- Large setting range 1 ... 120.000 IPM or 0.15 ... 20.000 Hz (10 ranges each)
- As option with input for NAMUR-sensors with sensor and wire protection against interruption and short circuit
- Adjustable hysteresis 0.5 ... 50 %
- Adjustable start up time delay 0 ... 50 s, control with external contact
- Adjustable monitoring time for missing input signal at function overfrequency; additional using as standstill level
- Programmable via terminals:
  - Alarm delay of 0 ... 100 s
  - with manual reset or auto reset
- LED-indication for auxiliary voltage, measuring input and output relay; additional LED for indication of wire- / sensor failure at NAMUR-input
- Auxiliary voltages AC 230 V and DC 24 V in one unit
- 2 changeover contacts, closed circuit operation
- Open circuit operation on request
- As option with analogue output, proportionally to speed
- Device available with 2 response values and separately controlled output relays for under- and overfrequency see MK 9055N/5\_ \_
- MH 9055 with wide input range for auxiliary voltage (AC/DC 24 ... 60 V or AC/DC 110 ... 230 V)
- 2 possible compact designs  
MK 9055N: Width 22,5 mm  
MH 9055: Width 45 mm

### Circuit Diagrams

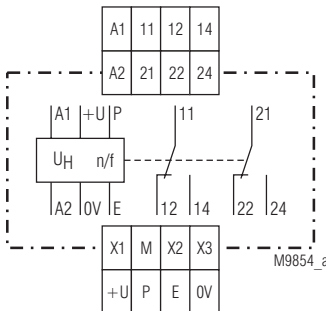

### Connection Terminal

Terminal designation	Signal description
A1+, A1	+ / L
A2	- / N
IN+, IN-, P, E	Measuring input
X1, X2, X3	Programming terminals
M	Ref. point programming terminals
UA	Analogue output voltage
IA	Analogue output current
+U / 0V	Sensor supply and alternative external auxiliary voltage DC 24 V
11, 12, 14; 21, 22, 24	Speed error-Indicator relay (2 changeover contacts)

### Approvals and Markings



### Setting

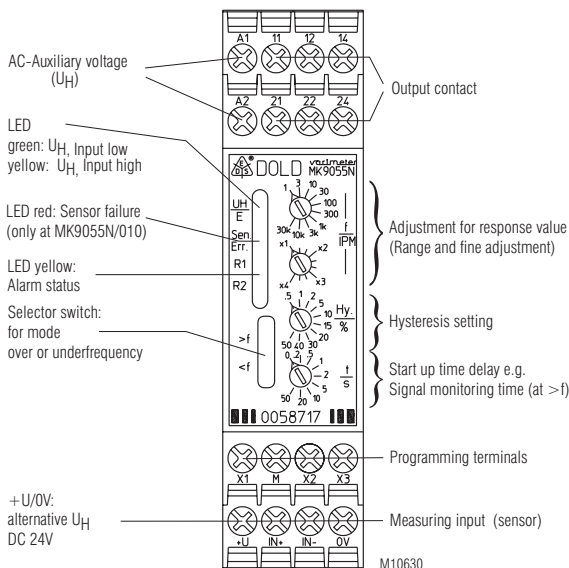

### Applications

- Speed monitoring on rotating machine parts
- Monitoring of cyclic movements
- General monitoring of pulse sequences (transportation, conveyors, production systems),
- Monitoring of pulse frequency (e.g. flow sensors, anemometers)

Function Diagram

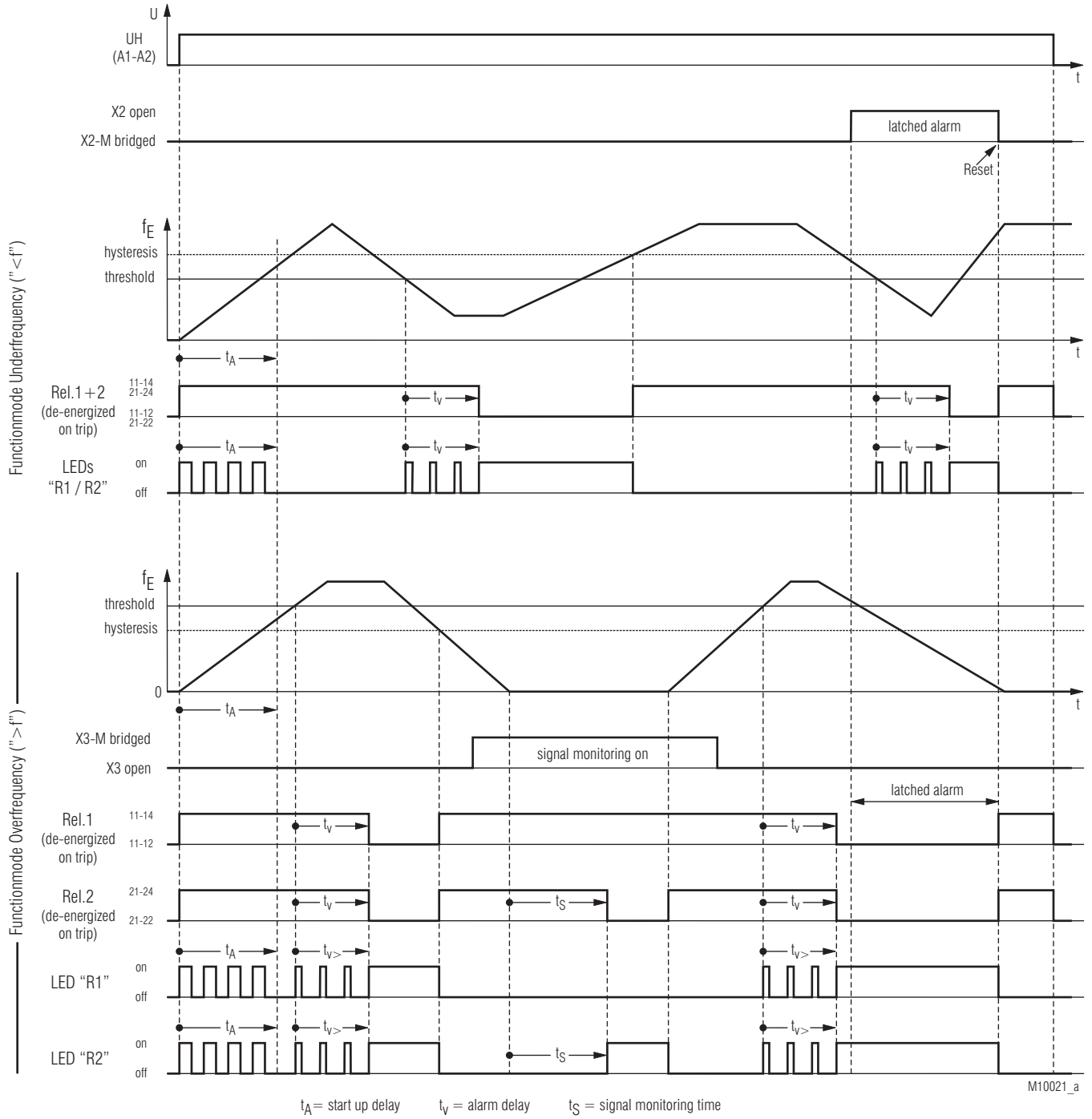

## Function

The auxiliary supply is connected to terminals A1-A2. An operation with alternatively DC 24 V is possible via terminals +U / 0V.

Different sensors can be connected to the measuring input that detects the speed pulses.

The input frequency is compared to the setting value (response value = fine tuning x range).

As the device measures the periods duration the fastest frequency measurement is possible.

In overfrequency mode (switch on front in pos. ">f") the output relays switches to alarm state if the input frequency rises above the response value for a longer time then selected on the terminals. If the measuring frequency drops again under the hysteresis value, the output relay switches back to good state without delay.

In underfrequency mode (switch on front in pos. "<f") the output relays switches to alarm state, if the input frequency drops below the response value for a longer time then selected on the terminals. If the measuring frequency rises again above the hysteresis value, the output relay switches back to good state without delay.

If manual reset is chosen, the output relay stays in tripped position, even if the frequency is back to normal. The reset is made by bridging terminals X2-M or by disconnecting the auxiliary supply.

In alarm state the yellow LEDs „R1“ / „R2“ are continuously on, during time delay they flash with short pulse.

In de-energized on trip mode the output relay is energized in good state (contacts 11-14, 21-24 etc. closed).

In energized on trip mode the output relay is energized in alarm state (contacts 11-14, 21-24 etc. closed).

If start up delay is selected a timer is started after connection of auxiliary supply that disables the measuring circuit for the adjusted time on terminal X3.

During this time the frequency measurement is disabled, the yellow LEDs "R1" and "R2" flash symmetrically and the output relays remain in "good" position.

This start up delay avoids an alarm e.g. when starting a generator or motor.

In overfrequency mode missing input signal can be monitored as option: If the signal is missing longer then the selected monitoring time, relay 2 (contacts 21-22-24) and LED "R2" indicate alarm.

The variant /010 (NAMUR sensor input) includes broken wire and short circuit monitoring of the sensor and connection wire. A red LED indicates this failure and the output relays switch off.

## Indicators

Upper LED "UH/E":	- green:	Auxiliary supply is present, measuring input is Low
	- yellow:	Auxiliary supply is present, measuring input is High
	- intermittent red/green flashing if U <sub>H</sub> and impuls sequence present	
Red LED "Sen.Err": (only at NAMUR input)	- on, when broken wire or interruption at sensor circuit detected	
Lower LED „R1“ (yellow):	- on, when alarm state (under- / overfrequency) flashes (with short pulse) when time delay is active	
Lower LED „R2“ (yellow):	- on, when alarm state (under- / overfrequency) flashes (with short pulse) when time delay is active	
	- additional flashes at signal monitoring alarm	
	LEDs "R1" and "R2" flash together during start up delay	

## Notes

### Universal measuring input

The universal input of the speed monitor (terminals +U, P, E, 0V) can handle a large variety of sensors (inductive or capacitive proximity sensors, ultra sonic, halleffect, optical sensors, light barriers, reed contacts etc.). The input is suitable for all sensors according to IEC / EN 60947-5-2 (VDE 0660 part 208).

Depending on the sensor that is used (3-wire PNP or NPN, 2-wire, contact) the connection to the input terminals could be different (see Connection Examples).

As the speed monitor is suitable for a very high maximum frequency, RC-elements need to be installed to suppress bouncing of contact sensors (see Connection Examples). It is possible to use standard RC-elements suitable for contact protection or RF interference protection.

### NAMUR input

The Variant M\_9055N/010 is optimized for the connection of NAMUR sensors according to IEC / EN 60947-5-6 (VDE 0660 Teil 212; former EN 50227 / DIN 19234). These 2-wire-sensors are connected to terminals IN+ / IN- (see application example).

Namur sensors have a defined current in ON as well as in OFF state. This allows to detect short circuits and broken wire on sensor and connection wires with this variant. Together with the upper green/yellow LED the type of failure is indicated:

Red LED "Sen..Err" ON and upper LED "UH/E" lights up green:

Broken wire at input circuit

Red LED "Sen..Err" ON and upper LED "UH/E" lights up yellow:

Short circuit at input circuit

Instead of a NAMUR sensor also a contact sensor with correspondent resistor circuit can be used (see Connection Examples). The suggested resistors are necessary to avoid broken wire or short circuit detection alarm. If the resistors are connected directly on the sensor side, the wiring still is monitored. Because of contact bouncing of mechanical contacts a capacitor has to be connected on the measuring input terminals.

### Sensor supply, 24V DC auxiliary supply as alternative

The input circuit (+U, P, E, 0V) is galvanic separated to the auxiliary supply A1, A2 (eg. AC 230V). By connecting AC 230V auxiliary voltage on terminals A1-A2 the unit provides a voltage of approx. 24 V max 20mA to supply external sensors. If the auxiliary supply is DC 24V or sensors with higher power consumption are used, the DC 24V auxiliary supply is connected to terminals +U / 0V. The sensors are also supplied from this source. (In this case there is no galvanic separation between auxiliary supply and measuring input).

### Monitoring indicator of sensor input

The upper 2-coloure LED shows the connected supply voltage and the electrical state of the measuring input:

Green: input E ist on LOW level

Yellow: input E ion HIGH level

Depending on the type of sensor (PNP, NPN, 2-wire, NO or NC contact) the actual state (active or inactive) is indicated.

Green / yellow: input pulses from sensor present

### Several speed monitors on one sensor

Parallel operation of several speed monitors on one sensor is possible the universal input e.g. to monitor several speed levels. The corresponding terminals are all connected in parallel.

### Start up delay / monitoring of measuring signal.

The start up time delay ( $t_A$ ) can be adjusted with the lowest potentiometer on the front side of the unit and is activated when connecting the auxiliary supply. If no start-up delay is required the potentiometer is turned fully antic-clockwise ( $t=0$ ).

In underfrequency mode (" $<f$ ") the start up delay can be extended/restarted at any time with a control contact between terminals X3-M. As long as X3-M is bridged the start up delay is continuously on and the frequency is not measured. When the link on X3-M is opened the start up delay time restarts.

In overfrequency mode (" $>f$ ") with a bridge on X3-M, the lowest potentiometer sets the measuring signal monitoring time ( $t_S$ ) (The adjusted time values  $t_A / t_S$  are identically).

When signal monitoring in mode ">f" is selected by bridging X3-M the measuring input is monitored as follows:

If during the adjusted monitoring time interval no measuring signal is detected, measuring signal alarm is indicated. As soon as the measuring signal returns the alarm status is reset (auto reset selected) and the monitoring interval  $t_S$  starts again.

The alarm status is indicated on relay 2 (contacts 21-22-24) and LED "R2" and can be easily differentiated from under/over frequency alarm where

**Notes**

both relays (contacts 11-12-14 and 21-22-24) and LEDs "R1" and "R2" are active.  
 The detection of missing measuring signal can increase the safety in critical applications on overfrequency. It detects if the measuring signal is connected to the input of the device and works correctly: It can be checked if the frequency input still delivers pulses. If a Namur sensor is used with variant /010 higher safety can be achieved by the integrated short circuit and broken wire detection.

**Second speed level / detection of overspeed and standstill**  
 The signal monitoring time setting in the overfrequency mode can also be used as second speed level, e.g. to detect standstill in addition to overspeed. To achieve this, the monitoring time is adjusted on the lower potentiometer to the reverse value of the pulse frequency that indicates standstill.

**Programming terminals (M-X1-X2-X3):**

**Attention!** The terminals M-X1-X2-X3 have no galvanic separation to the measuring circuit (+U / P / E / 0V) e.g. auxiliary voltage DC 24 V

- M: Common connection (Ground) of the programming terminals (identically with 0V)
- X1: A response delay of 0...100 s after connection of auxiliary supply is achieved by connecting a X1 to M with a potentiometer or fixed resistor (0.25 W) see technical data. The delay can be stopped by bridging X1 to M at any time. If no start up delay is required the terminals X1-M must be linked.
- X2: Manual reset with NO contact push button on X2-M, auto reset with terminals X2-M bridged.
- X3: When X3-M is bridged in mode "underfrequency" the start up delay is continuously active or the time is restarted. In mode overfrequency the monitoring of the measuring signal is switched on by bridging X3-M.

**Adjustment aid for start up delay and alarm delay**  
 During the elapse of start up delay and alarm delay the yellow LED „R1“ and „R2“ is flashing with a frequency of 2 Hz. To set a specific time value in seconds the number of flash pulses can be used to check the setting: Number of flash pulses divided by 2 = time delay in seconds.

**Variants with Analogue Output Indicating the Actual Speed / Frequency**

With this variant the programming terminal X3 is replaced by terminal UA or IA, that provides an analogue signal proportional to the speed with reference to terminal 0V. This signal is either 0 ... 10 V or 0 ... 20 mA or 4 ... 20 mA. As the X3 terminal is not available, these variants do not offer indication of missing speed signal in overfrequency mode and the start up delay can only be initiated when the auxiliary supply is switched on.  
 With the variant /017 (NAMUR sensor input with analogue output 4 ... 20 mA) the analogue output also indicates a sensor or wiring failure by switching the output to 0 mA.  
 The analogue output has no galvanic separation to measuring input and the alternative auxiliary supply on terminals +U/0V

**Technical Data**

**Frequency Measuring Input**

**Universal Input (+U / P / E 0V)**

for PNP-, NPN-, 2-wire sensors, contacts and voltages, connection see application examples;  
 suitable for all proximity sensors according to IEC / EN 60947-5-2 (VDE 0660 part 208)  
 built in power supply approx. DC 24 V / max. 20 mA on terminals +U / 0V;  
 Alternatively external auxiliary voltage supply DC 24 V via terminals +U / 0V

- Max. residual current**  
 at 2-wire sensors: 2 mA (OFF state)
- Max. voltage drops**  
 at 2-wire sensors: 8 V (ON state)
- Voltage control**  
 Input resistance: approx. 17 kΩ  
 Low-capability: ≤ 8 V  
 High-capability: ≥ 11 V

**NAMUR Input (Variant /010) IN+ / IN-**

- for NAMUR sensors according to IEC/EN 60947-5-6 (VDE 0660 part 212)
- No-load voltage:** approx. 8.2 V
  - Input resistance:** approx. 1 kΩ
  - Short circuit current:** approx. 8 mA
  - response value**  
 Low: typ. 1.55 mA  
 High: typ. 1.75 mA  
 Broken wire threshold: ≤ 0,15 mA  
 short circuit threshold: ≥ 6 mA

Alternatively external auxiliary voltage supply DC 24 V via terminals +U / 0V

**Common Data for Inputs**

**response value**  
 10 ranges: 1 ... 120.000 IPM

range	1	2	3	4	5	6	7	8	9	10
Imp. / min	1 to 4	3 to 12	10 to 40	30 to 120	100 to 400	300 to 1.200	1.000 to 4.000	3.000 to 12.000	10.000 to 40.000	30.000 to 120.000

or 0.15 ... 20.000 Hz

range	1	2	3	4	5	6	7	8	9	10
Hz	0.15 to 0.6	0,5 to 2	1,5 to 6	5 to 20	15 to 60	50 to 200	150 to 600	500 to 2.000	1.500 to 6.000	5.000 to 20.000

- Fine adjustment: infinite 1:4
- Max. input frequency**  
 (Impuls : Pause = 1 : 1)  
 Range 1 ... 4: 15 kHz  
 Range 5 ... 7: 5 kHz  
 Range 8 ... 10: 25 kHz
- Min. pulse- and breaktime**  
 Range 1 ... 4: 350 µs  
 Range 5 ... 7: 100 µs  
 Range 8 ... 10: 20 µs
- Stability of the setting threshold at variation of auxiliary voltage and temperature:** 2 %
- Hysteresis:** infinitely variable: 0.5 ... 50 % of the setting response value
- Reaction time of Frequency monitoring:**  
 (Alarm delay set to 0)  
 Duration of 1 cycle (inverse value of adjusted frequency) + 10 ms  
 (at over frequency: inverse value of signal frequency + 10 ms)

## Technical Data

**Response delay:** adjustable 0 ... 100 s with resistor/potentiometer across terminals X1-M:

R / kΩ:	0	15	22	33	47	68	100	150	220	470	∞
t <sub>v</sub> / s:	0	0.3	0.7	1.3	2.3	5	9	15	25	50	100

**Time between connection of auxiliary supply and ready to measure:** approx. 0.4 s (with start up delay is 0)

**Start up time delay / signal monitoring time:** continuously variable on logarithmic scale; t<sub>A</sub>: 0 ... 50 s, t<sub>S</sub>: 0,1 ... 50 s

### Auxiliary Voltage (A1-A2; e.g. +U / 0V)

**Auxiliary voltage U<sub>H</sub>:** AC 115, 230, 400 V + DC 24 V each (via terminals +U / 0V) (Terminals +U / 0V has no galvanic separation to measuring input)

AC/DC 24 ... 60, 110 ... 230 V (only for MH-version possible)

### Voltage range

AC: 0.8 ... 1.1 U<sub>H</sub>  
DC: 0.85 ... 1.2 U<sub>H</sub>  
AC/DC: 0.75 ... 1.2 U<sub>H</sub>

### Frequency range

AC: 45 ... 440 Hz

### Nominal consumption:

AC: approx. 4 VA  
DC: approx. 2 W

### Contact Output (11-12-14, 21-22-24)

**Contacts:** 2 changeover contacts  
**Thermal current I<sub>th</sub>:** 4 A

### Switching capacity

to AC 15

NO contacts: 3 A / AC 230 V IEC/EN 60 947-5-1

NC contacts: 1 A / AC 230 V IEC/EN 60 947-5-1

to DC 13

NO contacts: 1 A / DC 24 V IEC/EN 60 947-5-1

NC contacts: 1 A / DC 24 V IEC/EN 60 947-5-1

### Electrical life

to AC 15 at 1 A, AC 230 V: 1,5 x 10<sup>5</sup> switch.cycl. IEC/EN 60 947-5-1

### short circuit strength

**max. fuse rating:** 4 A gG / gL IEC/EN 60 947-5-1

**Mechanical life:** ≥ 30 x 10<sup>6</sup> switching cycles

### Analogue Voltage Output (variant /0\_5, terminal "UA" against "0V")

**Nominal output voltage:** 0 ... 10 V, linear proportional to the speed / frequency, without galvanic separation to measuring input and DC 24 V-supply

**Load:** max. 10 mA

**Scale:** 0 V at 0 IPM / Hz  
5 V at setting end of scale value of speed / frequency  
10 V at input frequency = 2 x end of scale value

**Accuracy:** 3 %

### Analogue Output (variant /0\_6, e.g. 0\_7; terminal "IA" against "0V")

**Output:** 0 ... 20 mA bzw. 4 ... 20 mA, linear proportional to the speed / frequency, without galvanic separation to measuring input and DC 24 V-supply

**Max. burden:** 500 Ω

**Scale:** 0 mA e.g. 4 mA at 0 IPM / Hz  
10 mA e.g. 12 mA at setting end of scale value  
20 mA at input frequency = 2 x end of scale value

### Fault signal at NAMUR input:

at output 4 ... 20 mA (variant /017) on sensor failure current drops to 0

**Accuracy:** 3 %

## Technical Data

### General Data

**Nominal operating mode:** continuous operation

### Temperature range

Operation: - 20 ... + 60 °C

Storage: - 20 ... + 60 °C

**Altitude:** < 2.000 m

### Clearance and creepage distance

rated impulse voltage /

pollution degree:

Contact to measuring input: 4 kV / 2 IEC 60 664-1

Contact to auxiliary circuit: 4 kV / 2 IEC 60 664-1

Contact to Contact: 4 kV / 2 IEC 60 664-1

Auxiliary circuit A1-A2 to measuring input: 4 kV / 2 IEC 60 664-1

Programming terminals

M-X1-X2-X3: without galv. separat. to measuring input

Auxiliary voltage DC 24 V (an +U / 0V): without galv. separat. to measuring input

Analogue output, optional (UA / IA): without galv. separat. to measuring input

### EMC

Electrostatic discharge: 8 kV (air) IEC/EN 61 000-4-2

HF-irradiation

80 MHz ... 1 GHz: 12 V / m IEC/EN 61 000-4-3

1 GHz ... 2.7 GHz: 10 V / m IEC/EN 61 000-4-3

Fast transients: 2 kV IEC/EN 61 000-4-4

Surge voltage

between

wires for power supply: 1 kV IEC/EN 61 000-4-5

HF-wire guided: 10 V IEC/EN 61 000-4-6

Interference suppression: Limit value class B EN 55 011

### Degree of protection:

Housing: IP 40 IEC/EN 60 529

Terminals: IP 20 IEC/EN 60 529

### Housing:

thermoplastic with VO behaviour

acc. to UL subject 94

Amplitude 0.35 mm

frequency 10 ... 55 Hz IEC/EN 60 068-2-6

20 / 060 / 04 IEC/EN 60 068-1

EN 50 005

**Wire connection:** 1 x 4 mm<sup>2</sup> solid or

2 x 2.5 mm<sup>2</sup> solid or

1 x 2.5 mm<sup>2</sup> stranded wire with sleeve

DIN 46 228-1/-2/-3/-4 oder

2 x 1.5 mm<sup>2</sup> stranded wire with sleeve

DIN 46 228-1/-2/-3/

Plus-minus terminal screws M3,5 box

terminals with wire protection

0.8 Nm

**Mounting:** DIN-rail IEC/EN 60 715

**Weight:** approx. 210 g

### Dimensions

#### Width x height x depth:

MK 9055N: 22.5 x 90 x 97 mm

MH 9055: 45 x 90 x 97 mm

### Standard Type

MK 9055N.12 1 ... 120.000 IPM U<sub>H</sub> AC 230 V

Article number: 0058715

- Universal input for PNP-, NPN-, 2-wire-sensors, contacts, voltage
- Selectable function: over- or underfrequency
- Selectable signal monitoring at overfrequency mode
- 10-fold selectable ranges: 1 ... 120.000 IPM
- Response value infinitely adjustable 1:4
- Hysteresis: adjustable from 0.5...50 %
- Start up time delay / signal monitoring time: adjustable from 0 ... 50 s
- Response delay: settable with external resistor to 0...100 s
- Alarm storing or auto-reset selectable
- Auxiliary voltage U<sub>H</sub>: AC 230 V + DC 24 V
- Closed circuit operation
- Output: 2 changeover contacts
- Width: 22.5 mm



## Standard Type

MK 9055N.12 0,15 ... 20.000 Hz  $U_H$  AC 230 V

Article number: 0058716

- Universal input for PNP-, NPN-, 2-wire-sensors, contacts, voltage
- Selectable function: over- or underfrequency
- Selectable signal monitoring at overfrequency mode
- 10-fold selectable ranges: 0,15 ... 20.000 Hz
- Response value uninfinitely adjustable 1:4
- Hysteresis: adjustable from 0.5...50 %
- Start up time delay / signal monitoring time: adjustable from 0 ... 50 s
- Response delay: settable with external resistor to 0...100 s
- Alarm storing or auto-reset selectable
- Auxiliary voltage  $U_H$ : AC 230 V + DC 24 V
- Closed circuit operation
- Output: 2 changeover contacts
- Width: 22.5 mm

## Variants

M\_ 9055\_ .12/0\_

- 0 Standard
- 5 Analogue output 0 ... 10 V (instead of terminal X3)
- 6 Analogue output 0 ... 20 mA (instead of terminal X3)
- 7 Analogue output 4 ... 20 mA (instead of terminal X3)
- 0 Universal input (standard)
- 1 NAMUR input with sensor monitoring

## Ordering example for variants

MK 9055N .12 /010 1 ... 120.000 IPM  $U_H$  AC 230 V

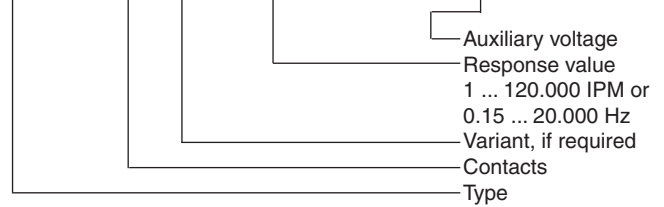

## Application Examples

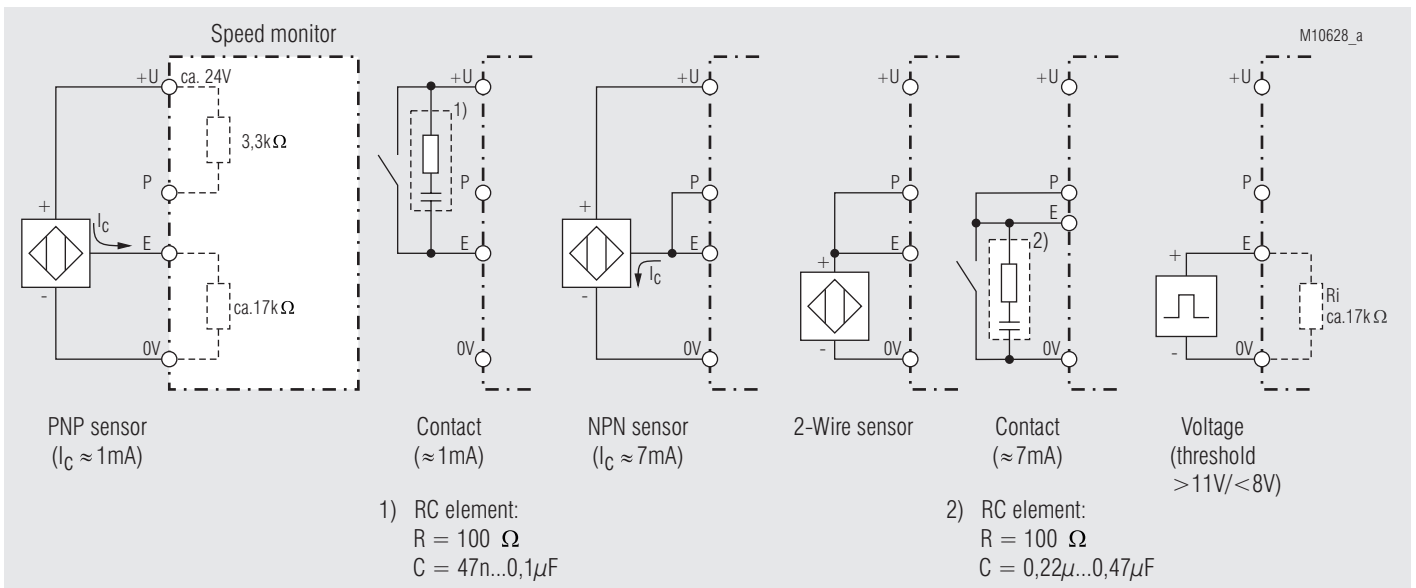

## Universal input

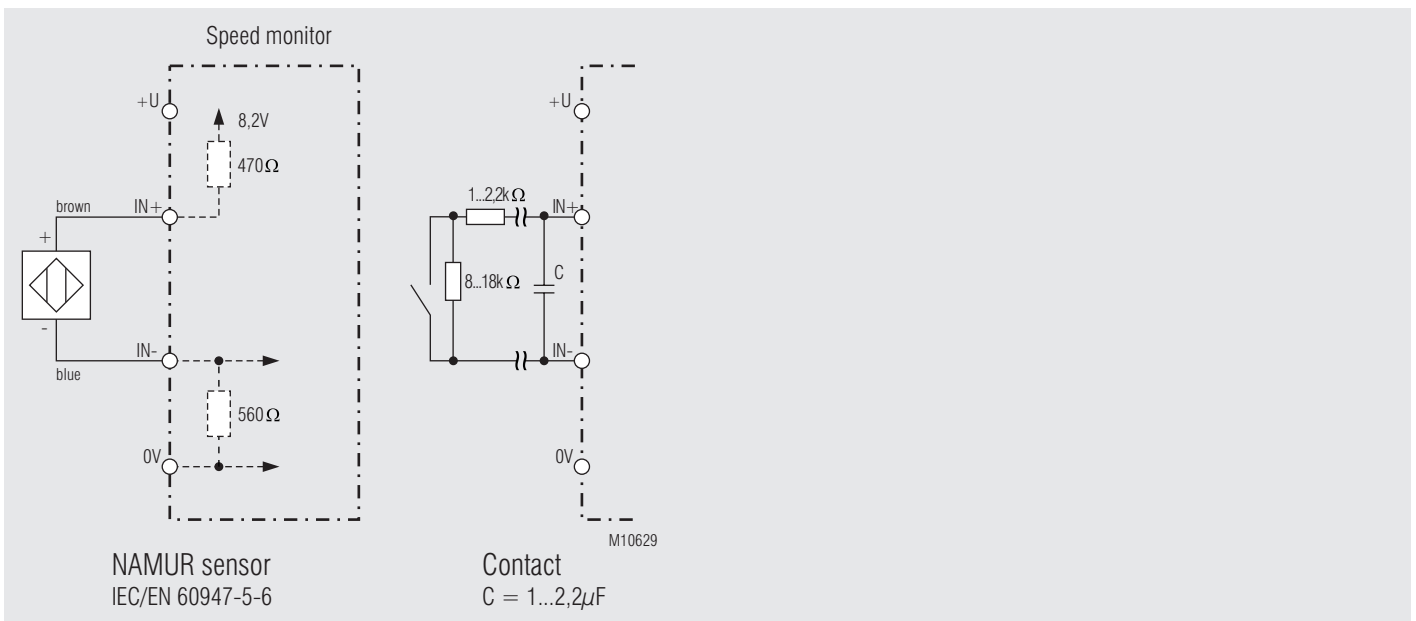

NAMUR input only at M\_ 9055.12/01\_

**Initiators (proximity sensors), inductive**

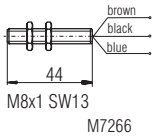
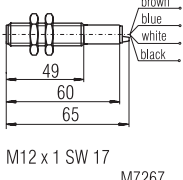
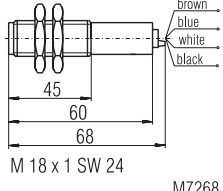
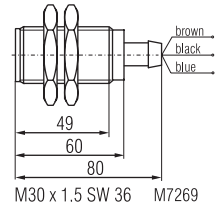
Type	NA 5001.01.10 pnp NA 5001.01.20 npn	NA 5002.01.34 pnp/npn	NA 5005.01.34 pnp/npn	NA 5010.01.10 pnp NA 5010.01.20 npn
Dimensions				
Enclosure	Metal	Metal	Metal	Metal
Switching distance $S_n$	1 mm	2 mm	5 mm	10 mm
Switching frequency	5 000 Hz	1 000 Hz	300 Hz	200 Hz
Hysteresis	2 ... 10 %			
Repeat accuracy	5 %			
Voltage range	10 ... 30 V			
Residual ripple	< 10 %			
Continuous current	≤ 200 mA	≤ 100 mA	≤ 100 mA	≤ 400 mA
Output	.10 pnp NO .20 npn NO	.34 pnp NO + npn NO	.34 pnp NO + npn NO	.10 pnp NO .20 npn NO
Indication of output state	LED			
Ambient temperature	- 25 ... 70°C			
Temperature influence	10 %			
Degree of protection	IP 67			
Connection wire	2 m			
Fixing torque	4 Nm	15 Nm	40 Nm	100 Nm
Weight	45 g	70 g	120 g	270 g

**Connection Table MK 9055N.12/00x, MH 9055.12/00x**

Type	Wire	Terminal on MK 9055N / MH 9055
NA 5001.01.10	brown +	+ U
	blue -	0 V
	black NO	E
NA 5002.01.34 NA 5005.01.34	brown +	+ U
	blanc +	+ U
	blue -	0 V
	black NO	E
NA 5010.01.10	brown +	+ U
	blue -	0 V
	black NO	E

**Connection Table MK 9055N.12/00x, MH 9055.12/00x**

Type	Wire	Terminal on MK 9055N / MH 9055
NA 5001.01.20	brown +	+ U
	blue -	0 V
	black NO	P, E
NA 5002.01.34 NA 5005.01.34	brown +	+ U
	blanc NO	P, E
	blue -	0 V
	black -	0 V
NA 5010.01.20	brown +	+ U
	blue -	0 V
	black NO	P, E

