

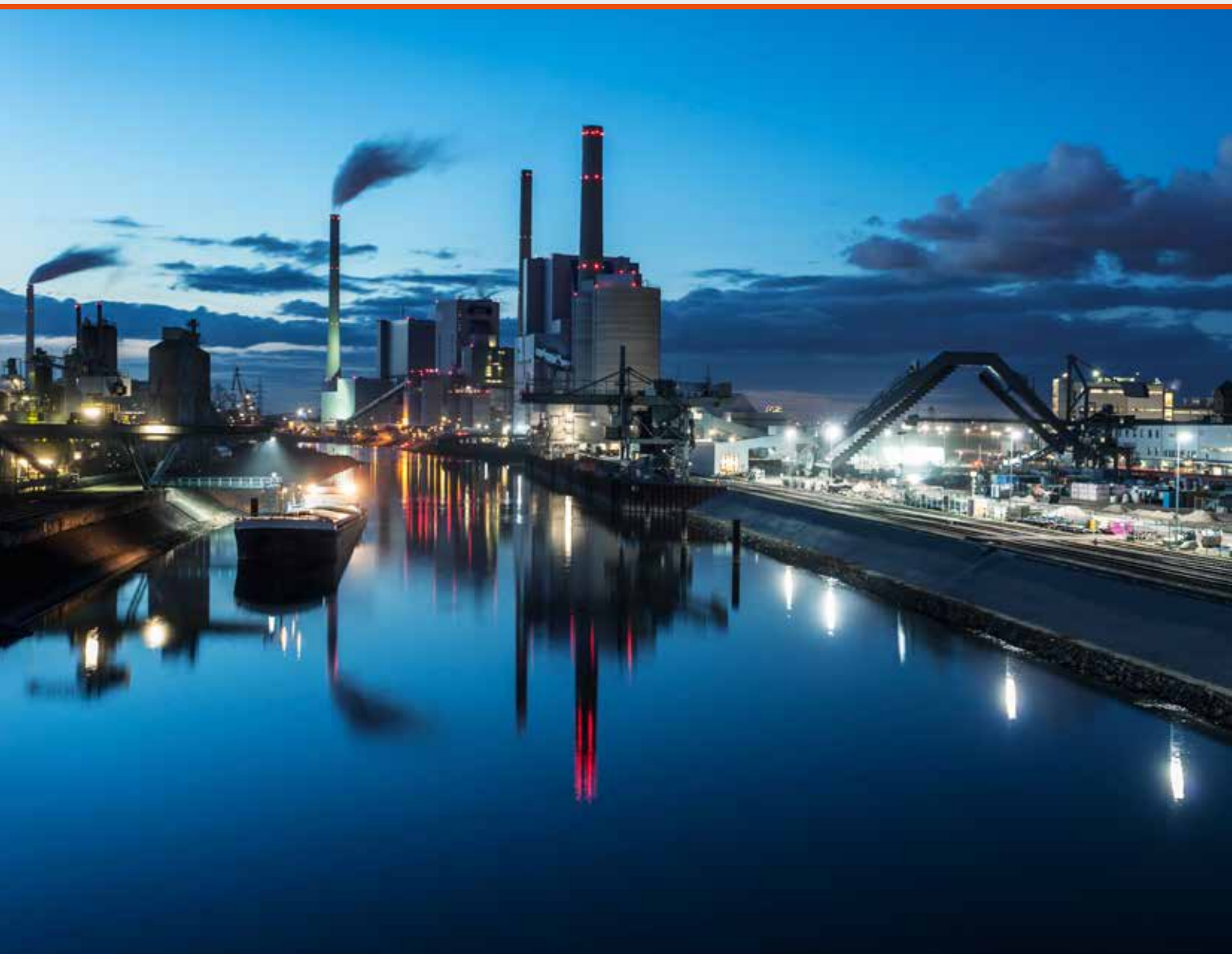

IEC FUSES & FUSEGEAR

BS88 LV
FUSE LINKS
& FUSE HOLDERS

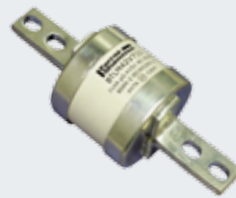

Powerful presence of the world's leader on the circuit protection market, Mersen Electrical Protection Activity, offer innovative solutions to enhance the safety of low voltage installations and equipments.

Above and beyond the supply of products, the company also provides added value in the form of technical support for OEMs, electrical contractors, panel builders, plant maintenance department and utilities.

As a global player, Mersen has established production facilities on every continent to optimise the offering (France, Tunisia, United States, Canada, Mexico, India, Japan and P.R. of China). All these locations are united around a global quality, safety and environment policy.

The world-class organisation of Mersen offers tried, proven and approved solutions ensuring the integrity of the equipment, their devices protected and the safety of people working around them. To guard customer's electrical equipment and installations over the long term, Mersen markets the widest range of safe, reliable electrical and thermal protection solutions.

Mersen solutions are sold all over the world at over 4500 points of sale through professional distributors of electrical components and equipment.

Mersen provides you with high quality products in compliance with ISO 9001 standard. All the circuit protection solutions shown in this catalogue are, ASTA 20 certified and comply with the RoHS European Directive.

Note that any items marked with * are not ASTA 20 certified.



INDEX

Range Mapping	4
Comparison Chart	5
Offset Bolted Tag Fuse Links (A-type)	
Reference Data (415V)	6
Dimensions & Electrical characteristics (415V)	7
Reference Data (550V)	12
Dimensions & Electrical characteristics (550V)	13 & 14
Reference Data (690V)	16
Dimensions & Electrical characteristics (690V)	17
Offset Blade Fuse Links (F-type)	
Reference Data (550V)	12
Dimensions & Electrical characteristics (550V)	13 & 14
Central Bolted Tag Fuse Links (B & C-type)	
Reference Data (415V)	8
Dimensions & Electrical characteristics (415V)	9
Reference Data (690V)	18
Dimensions & Electrical characteristics (690V)	19
Time Vs Current Characteristics (415V) - A, B & C type	10
Time Vs Current Characteristics (415/550V) - A & F type	15
Time Vs Current Characteristics (690V) - A, B & C type	20
Cut-Off Current Characteristics for A, B & C types (415V)	11
Cut-Off Current Characteristics for A, B, C & F Types (550/690V)	21
I² t characteristics & Power Dissipation chart	22
Application Information	23
BS88 Fuse Holders	24
Mersen Fuse Holder Chart	25
Approvals	30
Notes	31

RANGE MAPPING

BS TYPE	DESIGNATION	AC / DC	CATEGORY	CURRENT RATINGS	PAGE NO.
F1	BNS	550/250	gG	2, 4, 6, 10, 16, 20, 25, 32	12
			gM	10M16, 16M20, 20M25, 20M32, 25M32	
		415	gM	20M36, 32M36, 32M40, 32M50, 32M63	
F2	BES	550	gG	2, 4, 6, 10, 16, 20, 25, 32	6
		415	gG	36, 40, 50, 63	
A1	BEIT	415/250	gG	36, 40, 50, 63	6
	BNIT	550/250	gG	2, 4, 6, 10, 16, 20, 25, 32	12
			gM	10M16, 16M20, 20M25, 20M32, 25M32	
A2	BTIA	550/250	gG	2, 4, 6, 10, 16, 20, 25, 32	12
			gM	10M16, 16M20, 20M25, 20M32, 25M32	
		690/460	gG	2, 4, 6, 10, 16, 20, 25, 32, 36, 40, 50, 63	16
			gM	10M16, 16M20, 20M25, 20M32, 25M32, 32M36, 32M40, 32M50, 32M63	
A3	BTSS	415/240	gG	36, 40, 50, 63	6
	BTSDS	415/240	gG	80, 100, 125	
			gM	63M80, 63M100, 80M100, 100M125	
	BTIS	415/240	gG	36, 40, 50, 63, 80, 100, 125, 160	16
		690/460	gG	36, 40, 50, 63	
			gM	100M125, 100M160	
A4	BTSD	415/240	gG	80, 100, 125	6
			gM	63M80, 63M100, 80M100, 100M125	
	BTCP	415/240	gG	125, 160	16
		690/460	gG	36, 40, 50, 63, 80, 100	
			gM	100M125, 100M160, 100M200	
			gM	32M36, 32M40, 32M50, 32M63, 63M80, 63M100, 80M100	
BTFP	415/240	gG	125, 160, 200	6	
		gM	200M250, 200M315		
B1	BTBC	415/240	gG	32, 40, 50, 63	8
	BTSDC	415/240	gG	80, 100, 125	
			gM	63M80, 63M100, 80M100, 100M125	
	BTC	415/240	gG	125, 160	18
		690/460	gG	80, 100	
			gM	100M125, 100M160, 100M200	
B2	BTF	415/240	gG	125, 160, 200	8
			gM	200M250, 200M315	
		690/460	gG	125, 160, 200	18
			gM	125M160, 125M200	
B3	BTKF	415/240	gG	250, 315	8
			gM	315M400	
	BTKF	690/460	gG	250, 315	18
B3x	BTKM	415/240	gG	250, 315	8
B4	BTMF	415/240	gG	355, 400	8
		690/460	gG	250, 315, 355, 400	18
			gM	315M400	
C1	BTM	415/240	gG	355, 400	8
		690/460	gG	250, 315, 355, 400	18
C2	BTM	415/240	gG	450, 500, 560, 630	8
		690	gG	450, 500, 560, 630	18
C3	BTLM	415/240	gG	670, 710, 750, 800	8
		690	gG	670, 710, 750, 800	18

COMPARISON CHART FOR BS88LV FUSE LINKS

COMPETITORS		MERSEN	BS TYPE REF.	RATINGS	PAGES
NS-415V	NSD-550V	BNS55Vxx	F1	2-32A	12
ES-415V	-	BES42Vxx	F2	10-36A	12
-	ESD-550V	BES55Vxx	F2	40-63A	12
EIT-415V	-	BEIT42Vxx	A1	36-63A	6
NIT-415V	NITD-550V	BNIT55Vxx	A1	2-32A	12
TSA-415V	AA0-550V	BTIA55Vxx	A2C	2-32A	12
TIA-660V	H07-690V	BTIA69Vxx	A2	2-32A	16
TIS-660V	BA0-550V	BTIS69Vxx	A3	36-63A	16
TSS-415V	-	BTSS42Vxx	A3C	36-63A	6
TSDS-415V	-	BTSDS42Vxx	A3	80-125A	6
TSD-415V	-	BTSD42Vxx	A4C	80-125A	6
TCP-660V	L14-690V	BTCP69Vxxx	A4/A4C	36-100A	16
TSDC-415V	CD-415V	BTSDC42Vxxx	B1C	80-125A	8
TC-660V	L09-690V	BTC69Vxxx	B1	80-100A	18
TSFP-415V	DE0-415V	BTFP42Vxxx	A4xC	125-200A	6
TSF-415V	DD-415V	BTF42Vxxx	B2/B2C	125-200A	8
TFP-660V	M09-690V	BTF69Vxxx	B2	125-200A	18
TF-660V	M09-690V	BTF69Vxxx	B2	125-200A	18
TSK-415V	N09/P09-690V	BTMF69Vxxx	B4	250-400A	18
TKF-660V	N09/P09-690V	BTMF69Vxxx	B4	250-400A	18
TSMS-415V	P11-690V	BTM69Vxxx	C1	250-400A	18
TSM-415V	P11-690V	BTM69Vxxx	C1	250-400A	18
TM-660V	P11-690V	BTM69Vxxx	C1	250-400A	18
TSTS-415V	FF-550V	BTTM42Vxxx	C2	450-630A	18
TST-415V	FF-550V	BTTM42Vxxx	C2	450-630A	18
TTM-660V	FF-550V	BTTM69Vxxx	C2	450-630A	18
TSLS-415V	GF-550V	BTLM42Vxxx	C3	670-800A	18
TSL-415V	GF-550V	BTLM42Vxxx	C3	670-800A	18
TLM-660V	GF-550V	BTLM69Vxxx	C3	670-800A	18

OFFSET BOLTED TAG FUSE LINKS (A-TYPE)

Reference Data

Rated Voltage: 415 V ac Breaking Capacity: 80 kA
240/250 V dc Breaking Capacity: 40 kA

VOLTAGE (V) BS TYPE REF	RATING (A)	REFERENCE NUMBER	CATALOGUE NUMBER	BS TYPE REF	STD. PACK
415 V AC 250 V DC	36	A1019176J	BEIT42V36	A1	10
	40	B1019177J	BEIT42V40	A1	10
	50	C1019178J	BEIT42V50	A1	10
	63	D1019179J	BEIT42V63	A1	10
415 V AC 240 V DC	36	R1019191J	BTSS42V36	A3C	10
	40	S1019192J	BTSS42V40	A3C	10
	50	T1019193J	BTSS42V50	A3C	10
	63	V1019194J	BTSS42V63	A3C	10
415 V AC 240 V DC	80	E1019180J	BTS42V80	A3	10
	100	F1019181J	BTS42V100	A3	10
	125	G1019182J	BTS42V125	A3	10
	63M80	H1019183J	BTS42V63M80	A3	10
	63M100	J1019184J	BTS42V63M100	A3	10
	80M100	W1054362J	BTS42V80M100*	A3	10
415 V AC 240 V DC	100M125	K1019185J	BTS42V100M125	A3	10
	36	M1045269J	BTIS42V36	A3	10
	40	N1045270J	BTIS42V40	A3	10
	50	P1045271J	BTIS42V50	A3	10
	63	Q1045272J	BTIS42V63	A3	10
	80	R1045273J	BTIS42V80	A3	10
415 V AC 240 V DC	100	S1045274J	BTIS42V100	A3	10
	125	L1019186J	BTIS42V125	A3	10
	160	M1019187J	BTIS42V160	A3	10
	100M125	N1019188J	BTIS42V100M125	A3	10
415 V AC 240 V DC	100M160	Q1019190J	BTIS42V100M160	A3	10
	80	Y1019197J	BTS42V80	A4C	10
	100	Z1019198J	BTS42V100	A4C	10
	125	A1019199J	BTS42V125	A4C	10
415 V AC 240 V DC	63M80	B1019200J	BTS42V63M80	A4C	10
	63M100	C1019201J	BTS42V63M100	A4C	10
	80M100	X1054363J	BTS42V80M100*	A4C	10
	100M125	D1019202J	BTS42V100M125	A4C	10
	36	T1045275J	BTCP42V36	A4C	10
	40	Z1045280J	BTCP42V40	A4C	10
415 V AC 240 V DC	50	S1045297J	BTCP42V50	A4C	10
	63	T1045298J	BTCP42V63	A4C	10
	80	V1045299J	BTCP42V80	A4C	10
	100	X1045301J	BTCP42V100	A4C	10
415 V AC 240 V DC	125	W1019195J	BTCP42V125	A4	10
	160	X1019196J	BTCP42V160	A4	10
	100M125	A226297J	BTCP42V100M125	A4C	10
	100M160	B226298J	BTCP42V100M160	A4C	10
	100M200	C226299E	BTCP42V100M200	A4C	5
415 V AC 240 V DC	125	D226300E	BTFP42V125	A4XC	5
	160	E226301E	BTFP42V160	A4XC	5
	200	F226302E	BTFP42V200	A4XC	5
	200M250	G226303E	BTFP42V200M250	A4X	5
	200M315	H226304E	BTFP42V200M315	A4X	5



Note:

1. A3C, A4C represents compact dimensions with respect to BS88/ IEC60269 standards specified dimensions

2. A4X represents extended rating with respect to BS88 / IEC 60269 specified ratings

2. Note that items marked with an * are not ASTA certified

Dimensions

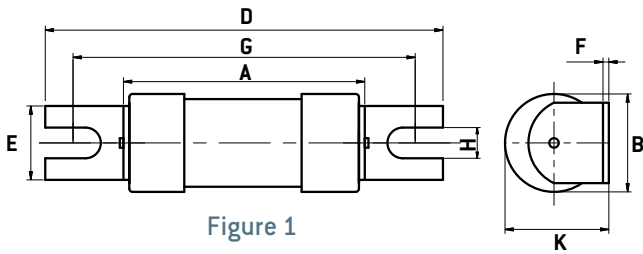

Figure 1

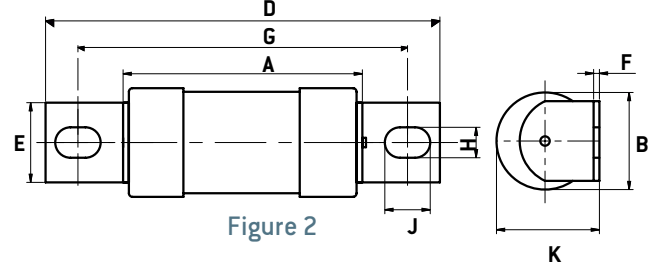

Figure 2

BS REF	FUSE TYPE (FIG. 1)	CURRENT RATING (A)	DIMENSIONS (MM)							
			A MAX	B MAX	D MAX	E MAX	F NOM	G NOM	H NOM	K MAX
A1	BEIT	36, 40, 50, 63	39.5	17.1	65.5	11	1.2	55	5.5	18.2
A3C	BTSS/BTIS	36, 40, 50, 63	38.8	17.1	84	9.2	1.2	73	5.2	18.5
A3	BTIS	125, 160, 100M125, 100M160	57	26.9	88.5	13	1.2	73	5.5	28

BS REF	FUSE TYPE (FIG. 2)	CURRENT RATING (A)	DIMENSIONS (MM)								
			A MAX	B MAX	D MAX	E MAX	F NOM	G NOM	H NOM	J NOM	K MAX
A3	BTSDES/BTIS	80, 100, 125, 63M80, 63M100, 80M100, 100M125	54.5	21	87	12.7	1.2	73	5.5	8	22.5
A4C	BTSD/BTCP	36, 40, 50, 63, 80, 100, 125, 63M80, 63M100, 80M100, 100M125	58.5	21	110	14.3	3.2	94	8.7	11	24.5
A4/ A4C	BTCP	125, 160, 100M125, 100M160	59.5	26.9	111	19.5	2.4	94	8.7	11	28.5
A4XC /A4C	BTFP/BTCP	125, 160, 200, 100M200	47	31	110	19	3.2	94	9	10	32
A4X	BTFP	200M250, 200M315	76	41.9	111	19.5	3.2	94	8.7	11	44

Electrical characteristics

FUSE TYPE	CURVE TYPE	CURRENT RATING (A)	I ² T (AMPERE ² SECONDS)		WATT LOSS
			PRE ARCING	TOTAL	
BEIT/BTSS/BTCP	gG	36	1000	4000	2.8
BEIT/BTSS/BTIS/BTCP	gG	40	1300	4200	3.0
BEIT/BTSS/BTIS/BTCP	gG	50	2600	8750	3.6
BEIT/BTSS/BTIS/BTCP	gG	63	4000	13900	4.7
BTSDES/BTSD/BTIS/BTCP	gG	80	8500	38250	6.5
BTSDES/BTSD	gM	63M80	8500	38250	5.1
BTSDES/BTSD/BTIS/BTCP	gG	100	14000	65000	7.5
BTSDES/BTSD	gM	63M100	14000	65000	4.7
BTSDES/BTSD	gM	80M100	14000	65000	6
BTSDES/BTSD	gG	125	16000	70000	11.5
BTIS/BTCP	gG	125	28000	78400	11.3
BTFP	gG	125	17000	70000	9.2
BTSDES/BTSD	gM	100M125	16000	70000	9.2
BTIS/BTCP	gM	100M125	28000	78400	9
BTIS/BTCP	gG	160	60000	168000	14.0
BTFP	gG	160	57000	150000	10.7
BTIS/BTCP	gM	100M160	60000	168000	8.8
BTFP	gG	200	105000	293000	16.2
BTCP	gM	100M200	105000	293000	8.1
BTFP	gM	200M250	190000	532000	19.2
BTFP	gM	200M315	270000	756000	19.7

CENTRAL BOLTED TAG FUSE LINKS (B & C-TYPE)

Reference Data

Rated Voltage: 415 V ac Breaking Capacity: 80 kA
240 V dc Breaking Capacity: 40 kA

VOLTAGE (V)	RATING (A)	REFERENCE NUMBER	CATALOGUE NUMBER	BS TYPE REF	STD. PACK
415 V AC 240 V DC	32	J226305J	BTBC42V32	B1C	10
	40	K226306J	BTBC42V40	B1C	10
	50	L226307J	BTBC42V50	B1C	10
	63	M226308J	BTBC42V63	B1C	10
415 V AC 240 V DC	80	G1019205J	BTSDC42V80	B1C	10
	100	H1019206J	BTSDC42V100	B1C	10
	125	J1019207J	BTSDC42V125	B1C	10
	63M80	K1019208J	BTSDC42V63M80	B1C	10
	63M100	L1019209J	BTSDC42V63M100	B1C	10
	80M100	Y1054364J	BTSDC42V80M100*	B1C	10
	100M125	M1019210J	BTSDC42V100M125	B1C	10
415 V AC 240 V DC	80	Y1045302J	BTC42V80	B1C	10
	100	Z1045303J	BTC42V100	B1C	10
415 V AC 240 V DC	125	E1019203J	BTC42V125	B1	10
	160	F1019204J	BTC42V160	B1	10
	100M125	Q226311J	BTC42V100M125	B1C	10
	100M160	R226312J	BTC42V100M160	B1C	10
	100M200	S226313E	BTC42V100M200	B1C	5
415 V AC 240 V DC	125	T226314E	BTF42V125	B2C	5
	160	V226315E	BTF42V160	B2C	5
	200	W226316E	BTF42V200	B2C	5
	200M250	X226317A	BTF42V200M250	B2	1
	200M315	Y226318A	BTF42V200M315	B2	1
415 V AC 240 V DC	250	Z226319A	BTKF42V250	B3	1
	315	A226320A	BTKF42V315	B3	1
	315M400	B226321A	BTKF42V315M400	B3	1
415 V AC 240 V DC	250	C226322A	BTKM42V250	B3X	1
	315	D226323A	BTKM42V315	B3X	1
415 V AC 240 V DC	355	E226324A	BTMF42V355	B4	1
	400	F226325A	BTMF42V400	B4	1
415 V AC 240 V DC	355	G226326A	BTM42V355	C1	1
	400	H226327A	BTM42V400	C1	1
415 V AC 240 V DC	450	J226328A	BTTM42V450	C2	1
	500	K226329A	BTTM42V500	C2	1
	560	L226330A	BTTM42V560	C2	1
	630	M226331A	BTTM42V630	C2	1
415 V AC 240 V DC	670	N226332A	BTLM42V670	C3	1
	710	P226333A	BTLM42V710	C3	1
	750	Q226334A	BTLM42V750	C3	1
	800	R226335A	BTLM42V800	C3	1

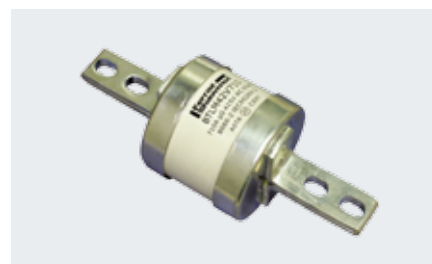

Note:

1. B1C, B2C represents compact dimensions with respect to BS88/ IEC60269 standards specified dimensions

2. B3X represents extended rating with respect to BS88 / IEC 60269 specified ratings

2. Note that items marked with an * are not ASTA Certified

Dimensions

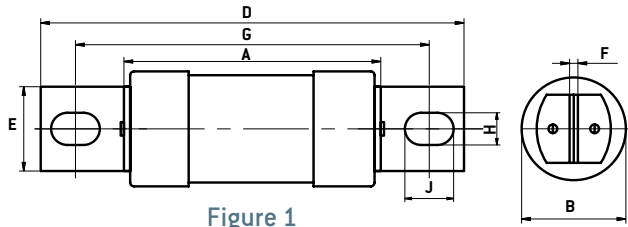

Figure 1

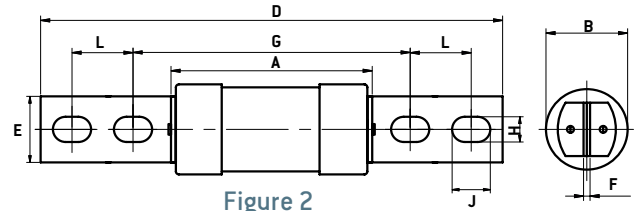

Figure 2

BS REF	FUSE TYPE	CURRENT RATING (A)	DIMENSIONS (MM)									
			A MAX	B MAX	D MAX	E MAX	F NOM	G NOM	H NOM	J NOM	LNOM	
FIG. 1												
B1C	BTBC	32, 40, 50, 63	57	26.9	137	19.5	3.2	111	8.7	14	-	
B1C	BTSDC/BTC	80, 100, 125, 63M80, 63M100, 80M100, 100M125	58.5	21	127	14.3	3.2	111	8.7	11.1	-	
B1/B1C	BTC	125, 160, 100M125, 100M160	57	26.9	137	19.5	3.2	111	8.7	14	-	
B1C/B2C	BTC/BTF	125, 160, 200, 100M200	47	31	136	19	3.2	111	9	12.5	-	
B2/B3	BTF/ BTKF	250, 315, 200M250, 200M315	73	41.9	138	19.5	3.2	111	8.7	14	-	
B3X	BTKM	250, 315	73	41.9	159	26	3.2	133	10.3	14	-	
B3	BTKF	250, 315, 315M400	75	59.1	138	26	4.8	111	8.7	14	-	
B4	BTMF	355, 400	75	59.1	138	26	4.8	111	8.1	14	-	
FIG. 2												
C1	BTM	355, 400	75	59.1	212	26	4.8	133	10.3	16	25.4	
C2	BTTM	450, 500, 560, 630	83	74.4	212	26	6.3	133	10.3	16	25.4	
C3	BTLM	670, 710, 750, 800	86	82.4	212	26	9.5	133	10.3	16	25.4	

Electrical characteristics

FUSE TYPE	CURVE TYPE	CURRENT RATING (A)	I ² T (AMPERE ² SECONDS)		WATT LOSS
			PRE ARCING	TOTAL	
BTBC	gG	32	700	3000	3.6
BTBC	gG	40	1300	5850	4.0
BTBC	gG	50	2600	11700	4.8
BTBC	gG	63	4000	17500	5.9
BTSDC/BTIS	gG	80	8500	38250	6.5
BTSDC	gM	63M80	8500	38250	5.1
BTSDC/BTIS	gG	100	14000	65000	7.5
BTSDC	gM	63M100	14000	65000	4.7
BTSDC	gM	80M100	14000	65000	6
BTSDC	gG	125	16000	70000	11.5
BTC	gG	125	28000	78400	11.3
BTF	gG	125	17000	70000	9.2
BTSDC	gM	100M125	16000	70000	9.2
BTC	gM	100M125	28000	78400	9
BTC	gG	160	60000	168000	14.0
BTF	gG	160	57000	150000	10.7
BTC	gM	100M160	60000	168000	8.8
BTF	gG	200	105000	293000	16.2
BTC	gM	100M200	105000	293000	8.1
BTKF/BTKM	gG	250	190000	532000	24
BTF	gM	200M250	190000	532000	19.2
BTKF/BTKM	gG	315	270000	756000	31
BTF	gM	200M315	270000	756000	19.7
BTKF	gM	315M400	505000	1414000	30
BTMF/BTM	gG	355	395000	1106000	32
BTMF/BTM	gG	400	505000	1414000	38
BTTM	gG	450	650000	1820000	42
BTTM	gG	500	850000	2380000	48
BTTM	gG	560	1200000	3360000	50
BTTM	gG	630	1546000	4437000	54
BTLM	gG	670	1950000	5460000	60
BTLM	gG	710	2400000	6720000	62
BTLM	gG	750	3000000	8400000	65
BTLM	gG	800	3769000	10900000	68

TIME VS. CURRENT CHARACTERISTICS

gG Curves - 32 to 800A - 415 V ac

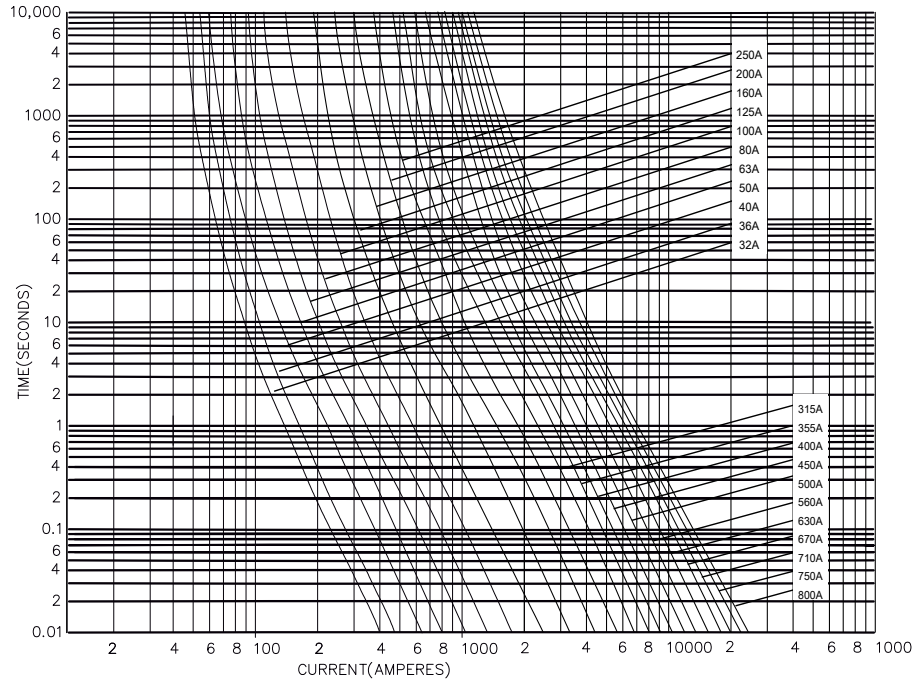

gM Curves - 63M80 to 315M400A - 415V ac

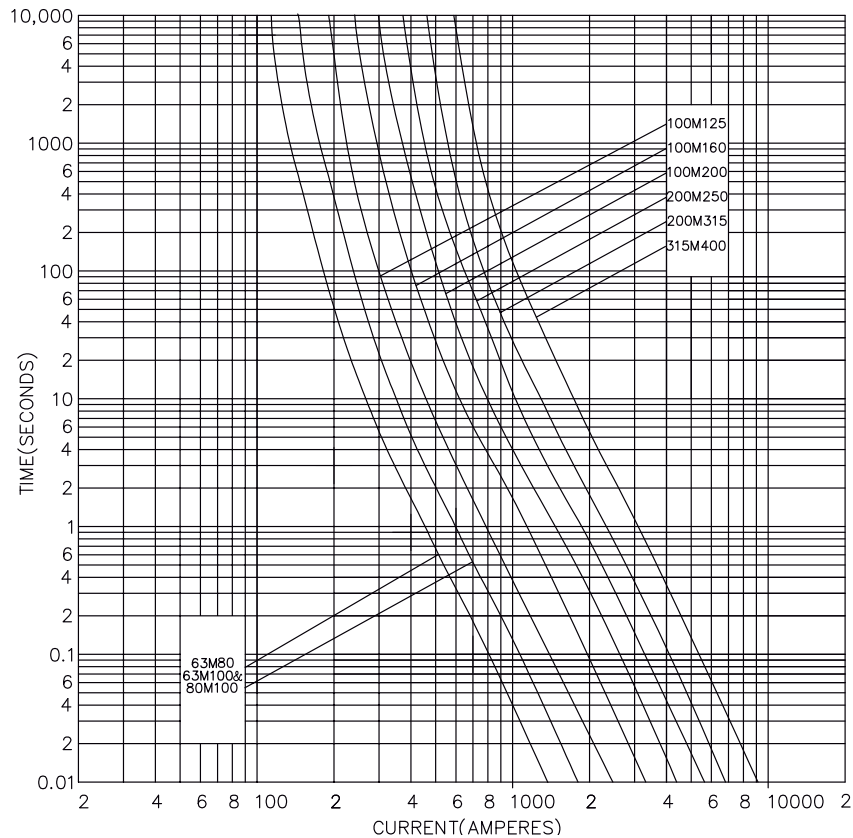

CUT-OFF CURRENT CHARACTERISTICS

A, B & C Type - 415 V ac

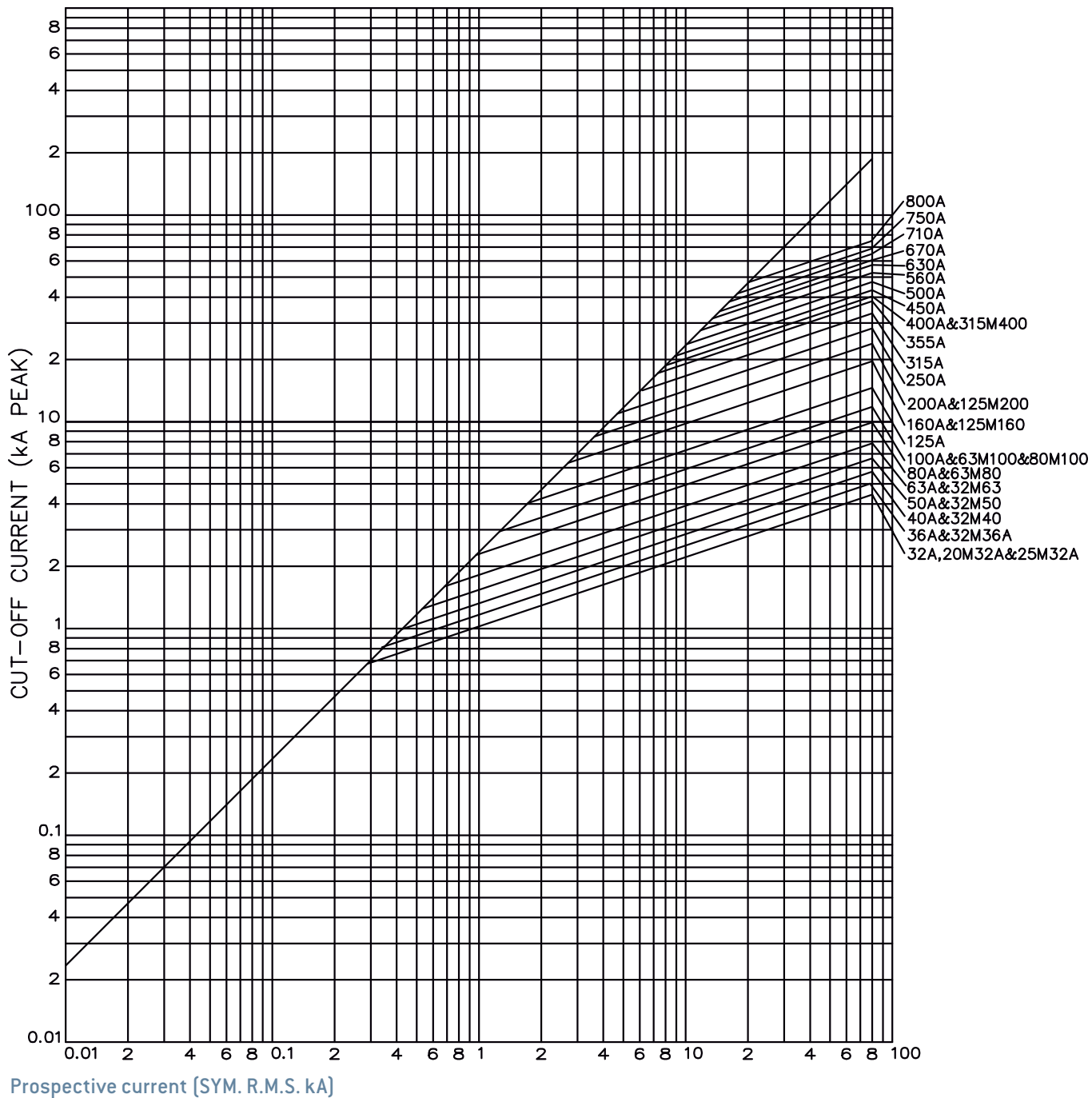

OFFSET BLADE/OFFSET TAG FUSE LINKS (F&A-TYPE)

Reference Data

Rated Voltage: 415/550 V ac Breaking Capacity: 80 kA
250 V dc Breaking Capacity: 40 kA

VOLTAGE (V)	RATING (A)	REFERENCE NO.	CATALOGUE NO.	BS TYPE REF	STD. PACK	
550 V AC 250 V DC	2	C1006643J	BNS55V2	F1	10	
	4	D1006644J	BNS55V4	F1	10	
	6	E1006645J	BNS55V6	F1	10	
	10	N1019211J	BNS55V10	F1	10	
	16	P1019212J	BNS55V16	F1	10	
	20	Q1019213J	BNS55V20	F1	10	
	25	R1019214J	BNS55V25	F1	10	
	32	S1019215J	BNS55V32	F1	10	
	10M16	T1019216J	BS55V10M16	F1	10	
	16M20	V1019217J	BNS55V16M20	F1	10	
	20M25	W1019218J	BNS55V20M25	F1	10	
	20M32	X1019219J	BNS55V20M32	F1	10	
25M32	Z1019221J	BNS55V25M32	F1	10		
415 V AC	20M36	D1036981J	BNS42V20M36*	F1	10	
	32M36	E1036982J	BNS42V32M36*	F1	10	
	32M40	F1036983J	BNS42V32M40*	F1	10	
	32M50	G1036984J	BNS42V32M50*	F1	10	
	32M63	H1036985J	BNS42V32M63*	F1	10	
550 V AC	2	Y1050799J	BES55V2*	F2	10	
	4	Z1050800J	BES55V4*	F2	10	
	6	A1050801J	BES55V6*	F2	10	
	10	F1006646J	BES55V10	F2	10	
	16	G1006647J	BES55V16	F2	10	
	20	H1006648J	BES55V20	F2	10	
	25	J1006649J	BES55V25	F2	10	
	32	K1006650J	BES55V32	F2	10	
415 V AC	36	L1006651J	BES55V36	F2	10	
	40	J226351J	BES42V40	F2	10	
	50	K226352J	BES42V50	F2	10	
415 V AC	63	L226353J	BES42V63	F2	10	
	550 V AC 250 V DC	2	E1006576J	BNIT55V2	A1	10
		4	F1006577J	BNIT55V4	A1	10
6		G1006578J	BNIT55V6	A1	10	
10		B1019223J	BNIT55V10	A1	10	
16		C1019224J	BNIT55V16	A1	10	
20		D1019225J	BNIT55V20	A1	10	
25		E1019226J	BNIT55V25	A1	10	
32		F1019227J	BNIT55V32	A1	10	
10M16		G1019228J	BNIT55V10M16	A1	10	
16M20		H1019229J	BNIT55V16M20	A1	10	
20M25		J1019230J	BNIT55V20M25	A1	10	
20M32		K1019231J	BNIT55V20M32	A1	10	
25M32	R1019237J	BNIT55V25M32	A1	10		
550 V AC 250 V DC	2	S1019238J	BTIA55V2	A2C	10	
	4	T1019239J	BTIA55V4	A2C	10	
	6	V1019240J	BTIA55V6	A2C	10	
	10	W1019241J	BTIA55V10	A2C	10	
	16	X1019242J	BTIA55V16	A2C	10	
	20	Y1019243J	BTIA55V20	A2C	10	
	25	Z1019244J	BTIA55V25	A2C	10	
	32	A1019245J	BTIA55V32	A2C	10	
	10M16	B1019246J	BTIA55V10M16	A2C	10	
	16M20	C1019247J	BTIA55V16M20	A2C	10	
	20M25	D1019248J	BTIA55V20M25	A2C	10	
	20M32	E1019249J	BTIA55V20M32	A2C	10	
	25M32	F1019250J	BTIA55V25M32	A2C	10	
	415 V AC 250 V DC	32M40	G226280J	BTIA42V32M40	A2	10
		32M50	H226251J	BTIA42V32M50	A2	10
32M63		K226383J	BTIA42V32M63	A2	10	



Note:

1. A2C, represents compact dimensions with respect to BS88/ IEC60269 standards specified dimensions

2. Note that items marked with an * are not ASTA Certified

Dimensions

Rated Voltage: 415/550 V ac Breaking Capacity: 80 kA

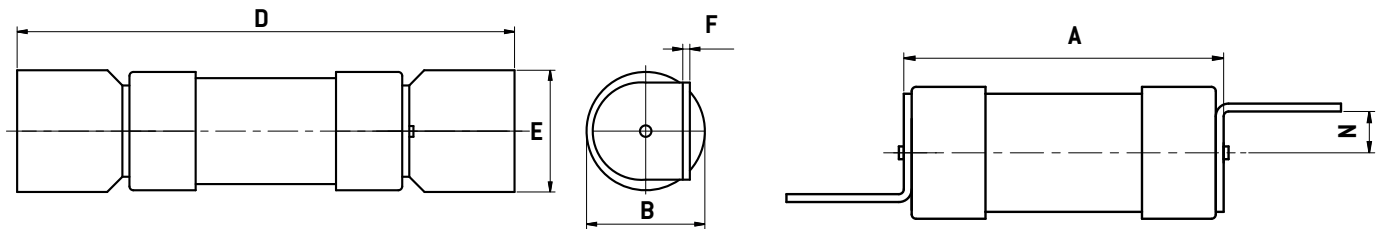

BS REF	FUSE TYPE	CURRENT RATING (A)	DIMENSIONS (MM)					
			A MAX	B MAX	D MAX	E MAX	F NOM	N NOM
F1	BNS	2, 4, 6, 10, 16, 20, 25, 32, 10M16, 16M20, 20M25, 20M32, 25M32	35.5	13.5	61	12.7	0.8	3.5
F1	BNS	20M36, 32M36, 32M40, 32M50, 32M63	35.5	17.1	61	12.7	0.8	3.5
F2	BES	2, 4, 6, 10, 16, 20, 25, 32, 36, 40, 50, 63	39.5	17.1	69	15.2	1.2	3.5

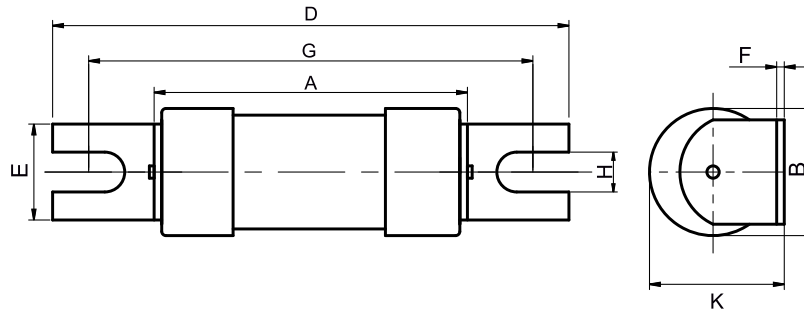

BS REF	FUSE TYPE	CURRENT RATING (A)	DIMENSIONS (MM)							
			A MAX	B MAX	D MAX	E MAX	F NOM	G NOM	H NOM	K MAX
A1	BNIT	2, 4, 6, 10, 16, 20, 25, 32, 10M16, 16M20, 20M25, 20M32, 25M32	35.5	13.5	56	11.2	0.8	44.5	4.8	14.5

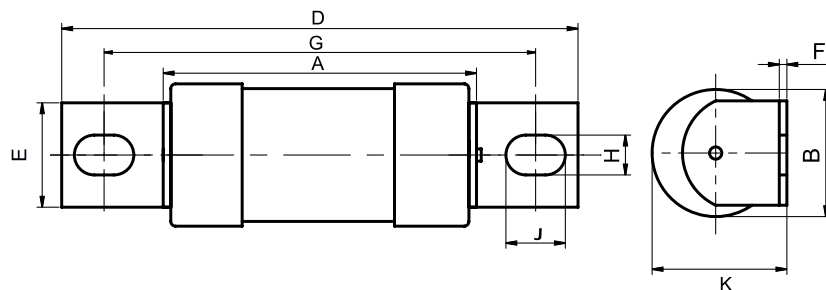

BS REF	FUSE TYPE	CURRENT RATING (A)	DIMENSIONS (MM)								
			A MAX	B MAX	D MAX	E MAX	F NOM	G NOM	H NOM	J MAX	K NOM
A2C	BTIA	2, 4, 6, 10, 16, 20, 25, 32, 10M16, 16M20, 20M25, 20M32, 25M32	35.5	13.5	86	9.2	0.8	73	8	5.5	14.5
A2	BTIA	32M40, 32M50, 32M63	56.5	21.9	86	9.2	1.2	73	8	5.5	23.5

Electrical characteristics

FUSE TYPE	CURVE TYPE	CURRENT RATING (A)	I ² T (AMPERE ² SECONDS)		WATT LOSS
			PRE ARCING	TOTAL	
BNS/BNIT/BTIA	gG	2	1	5	0.9
BNS/BNIT/BTIA	gG	4	7.6	38	1.5
BNS/BNIT/BTIA	gG	6	28	40	1.8
BNS/BNIT/BTIA/BES	gG	10	70	350	1.2
BNS/BNIT/BTIA/BES	gG	16	120	550	1.6
BNS/BNIT/BTIA	gM	10M16	120	550	1
BNS/BNIT/BTIA/BES	gG	20	250	1250	1.7
BNS/BNIT/BTIA	gM	16M20	250	1250	1.36
BNS/BNIT/BTIA/BES	gG	25	420	2100	2
BNS/BNIT/BTIA	gM	20M25	420	2100	1.6
BNS/BNIT/BTIA/BES	gG	32	670	3350	2.9
BNS/BNIT/BTIA	gM	20M32	670	3350	1.8
BNS/BNIT/BTIA	gM	25M32	670	3350	2.3
BNS/BES	gG	36	700	4000	2.8
BNS	gM	20M36	700	4000	1.6
BNS/BES	gG	40	1300	4200	3
BNS	gM	32M40	1300	4200	2.4
BNS/BES	gG	50	2600	8750	3.6
BNS	gM	32M50	2600	8750	2.3
BNS/BES	gG	63	4000	13900	4.7
BNS	gM	32M63	4000	13900	2.4

TIME VS. CURRENT CHARACTERISTICS

gG Curve-2 to 63A - 415/550 V ac

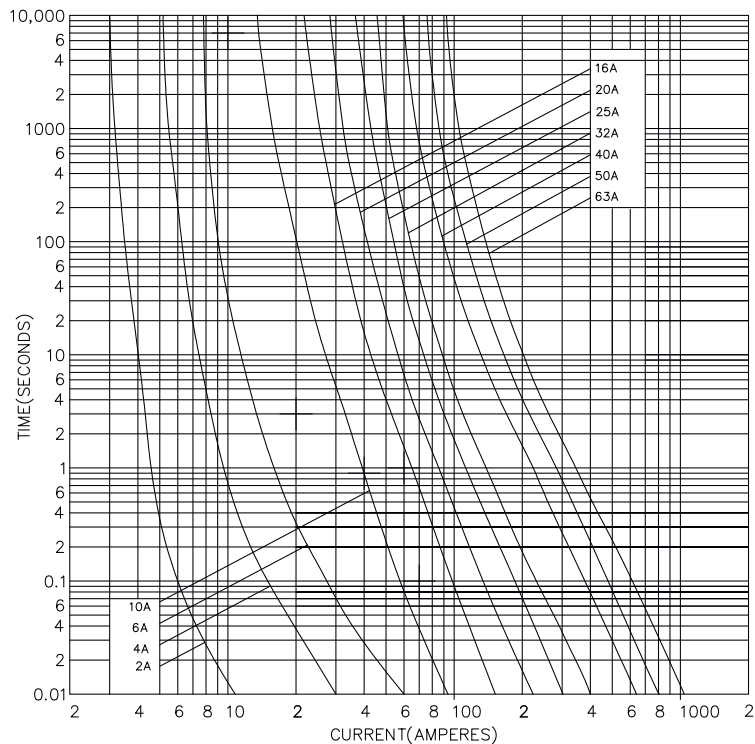

gM Curve-10M16 to 32M63-415/550 V ac

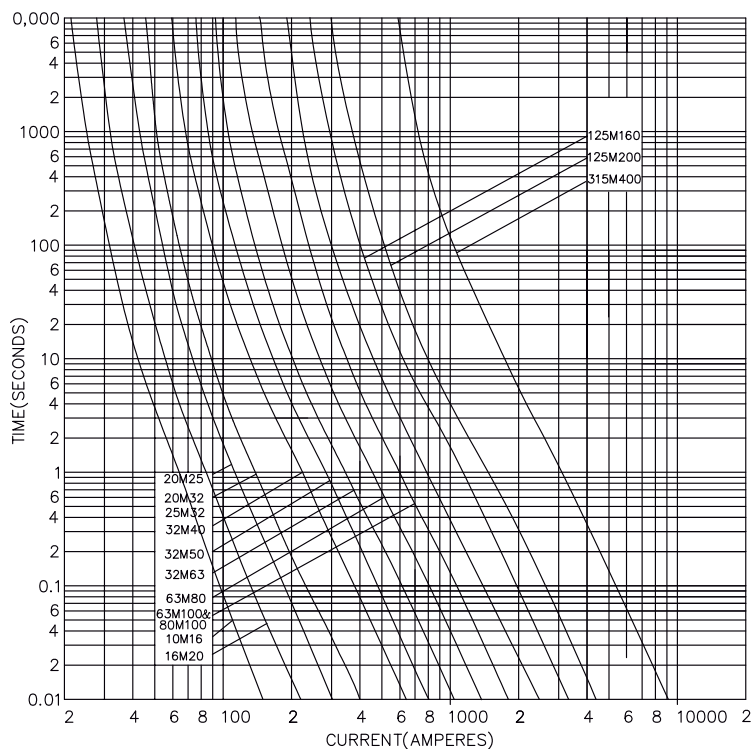

CENTRAL BOLTED TAG FUSE LINKS (B & C-TYPE)

Reference Data

Rated Voltage: 415 V ac Breaking Capacity: 80 kA
240 V dc Breaking Capacity: 40 kA

VOLTAGE (V)	RATING (A)	REFERENCE NUMBER	CATALOGUE NUMBER	BS TYPE REF	STD. PACK
690 V AC 460 V DC	2	G1019251J	BTIA69V2	A2	10
	4	H1019252J	BTIA69V4	A2	10
	6	J1019253J	BTIA69V6	A2	10
	10	K1019254J	BTIA69V10	A2	10
	16	L1019255J	BTIA69V16	A2	10
	20	M1019256J	BTIA69V20	A2	10
	25	N1019257J	BTIA69V25	A2	10
	32	P1019258J	BTIA69V32	A2	10
	10M16	A1019751J	BTIA69V10M16	A2	10
	16M20	B1019752J	BTIA69V16M20	A2	10
	20M25	Q1019259J	BTIA69V20M25	A2	10
	20M32	R1019260J	BTIA69V20M32	A2	10
	25M32	C1019753J	BTIA69V25M32	A2	10
	36	S1019261J	BTIA69V36	A2	10
	40	T1019262J	BTIA69V40	A2	10
	50	V1019263J	BTIA69V50	A2	10
	690 V AC 460 V DC	63	W1019264J	BTIA69V63	A2
32M36		A1019268J	BTIA69V32M36	A2	10
32M40		X1019265J	BTIA69V32M40	A2	10
32M50		Y1019266J	BTIA69V32M50	A2	10
32M63		Z1019267J	BTIA69V32M63	A2	10
36		N1006584J	BTIS69V36	A3	10
40		P1006585J	BTIS69V40	A3	10
50		Q1006586J	BTIS69V50	A3	10
690 V AC 460 V DC	63	R1006587J	BTIS69V63	A3	10
	32M36	C1019270J	BTIS69V32M36	A3	10
	32M40	D1006598J	BTIS69V32M40	A3	10
	32M50	E1006599J	BTIS69V32M50	A3	10
	32M63	F1006600J	BTIS69V32M63	A3	10
	36	H1019275J	BTCP69V36	A4C	10
	40	M1006606J	BTCP69V40	A4C	10
	50	N1006607J	BTCP69V50	A4C	10
	63	J1019276J	BTCP69V63	A4C	10
	32M36	K1019277J	BTCP69V32M36	A4C	10
690 V AC 460 V DC	32M40	L1019278J	BTCP69V32M40	A4C	10
	32M50	M1019279J	BTCP69V32M50	A4C	10
	32M63	N1019280J	BTCP69V32M63	A4C	10
	80	S1006611J	BTCP69V80	A4	10
	100	T1006612J	BTCP69V100	A4	10
	63M80	V1006613J	BTCP69V63M80	A4	10
	63M100	W1006614J	BTCP69V63M100	A4	10
	80M100	Z1054365J	BTCP69V80M100*	A4	10



Note:

1. A4C represents compact dimensions with respect to BS88/ IEC60269 standards specified dimensions

2. Note that items marked with an * are not ASTA Certified

OFFSET BOLTED TAG FUSE LINKS (A-TYPE)

Dimensions

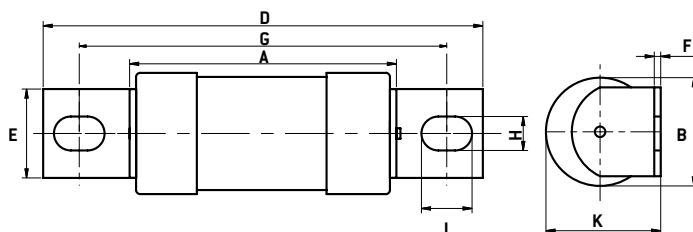

BS REF	FUSE TYPE	CURRENT RATING (A)	DIMENSIONS (MM)								
			A MAX	B MAX	D MAX	E MAX	F NOM	G NOM	H NOM	J NOM	K MAX
A2	BTIA	2, 4, 6, 10, 16, 20, 25, 32, 10M16, 16M20, 20M25, 20M32, 25M32	56.5	21.9	86	9.2	1.2	73	5.5	8	23.5
A2	BTIA	36, 40, 50, 63, 32M36, 32M40, 32M50, 32M63	54.5	21	86	8.7	1.2	73	5.5	8	22.3
A3	BTIS	36, 40, 50, 63, 32M36, 32M40, 32M50, 32M63	54.5	21	87	12.7	1.2	73	5.5	8	22.5
A4C	BTCP	36, 40, 50, 63, 32M36, 32M40, 32M50, 32M63	57.5	21	109	14.3	3.2	94	8.7	11	22.3
A4	BTCP	80, 100, 63M80, 63M100, 80M100	59.5	26.9	111	19.5	2.4	94	8.7	11	28.5

Electrical characteristics

FUSE TYPE	CURVE TYPE	CURRENT RATING (A)	I ² T (AMPERE ² SECONDS)		WATT LOSS
			PRE ARCING	TOTAL	
BTIA	gG	2	1	6.5	0.8
BTIA	gG	4	7.6	50	1.4
BTIA	gG	6	28	180	1.7
BTIA	gG	10	70	380	1.2
BTIA	gG	16	120	580	1.6
BTIA	gM	10M16	120	580	1
BTIA	gG	20	250	1450	1.7
BTIA	gM	16M20	250	1450	1.4
BTIA	gG	25	420	2500	2.0
BTIA	gM	20M25	420	2500	1.6
BTIA	gG	32	670	3900	2.9
BTIA	gM	20M32	670	3900	1.8
BTIA	gM	25M32	670	3900	2.3
BTIA/BTIS/BTCP	gG	36	700	4500	3.8
BTIA/BTIS/BTCP	gM	32M36	700	4500	3.4
BTIA/BTIS/BTCP	gG	40	1300	7400	4.0
BTIA/BTIS/BTCP	gM	32M40	1300	7400	3.2
BTIA/BTIS/BTCP	gG	50	2600	15000	4.8
BTIA/BTIS/BTCP	gM	32M50	2600	15000	3
BTIA/BTIS/BTCP	gG	63	4000	23000	5.9
BTIA/BTIS/BTCP	gM	32M63	4000	23000	3
BTCP	gG	80	8500	48500	6.5
BTCP	gM	63M80	8500	48500	5.1
BTCP	gG	100	14000	80000	7.5
BTCP	gM	63M100	14000	80000	4.7
BTCP	gM	80M100	14000	80000	6

CENTRAL BOLTED TAG FUSE LINKS (B&C-TYPE)

Reference Data

Rated Voltage: 690 V ac Breaking Capacity: 80 kA
460 V dc Breaking Capacity: 40 kA

VOLTAGE (V)	RATING (A)	REFERENCE NUMBER	CATALOGUE NUMBER	BS TYPE REF	STD. PACK
690 V AC 460 V DC	80	B1019775J	BTC69V80	B1	10
	100	A1006618J	BTC69V100	B1	10
	63M80	B1006619J	BTC69V63M80	B1	10
	63M100	C1006620J	BTC69V63M100	B1	10
	80M100	A1054366J	BTC69V80M100*	B1	10
690 V AC 460 V DC	125	D1006621E	BTF69V125	B2	5
	160	E1006622E	BTF69V160	B2	5
	200	F1006623E	BTF69V200	B2	5
	125M160	G1006624E	BTF69V125M160	B2	5
	125M200	H1006625E	BTF69V125M200	B2	5
690 V AC 460 V DC	250	P1036991A	BTKF69V250	B3	1
	315	Q1036992A	BTKF69V315	B3	1
690 V AC 460 V DC	250	J1006626A	BTMF69V250	B4	1
	315	K1006627A	BTMF69V315	B4	1
	355	L1006628A	BTMF69V355	B4	1
	400	M1006629A	BTMF69V400	B4	1
	315M400	N1006630A	BTMF69V315M400	B4	1
690 V AC 460 V DC	250	P1006631A	BTM69V250	C1	1
	315	R1006633A	BTM69V315	C1	1
	355	S1006634A	BTM69V355	C1	1
	400	W1006637A	BTM69V400	C1	1
690 V AC	450	Y1006639A	BTTM69V450	C2	1
	500	Z1006640A	BTTM69V500	C2	1
	560	A1006641A	BTTM69V560	C2	1
	630	B1006642A	BTTM69V630	C2	1
690 V AC	670	D1019271A	BTLM69V670	C3	1
	710	E1019272A	BTLM69V710	C3	1
	750	F1019273A	BTLM69V750	C3	1
	800	G1019274A	BTLM69V800	C3	1



Note:
1. Note that items marked with an * are not ASTA Certified.

Dimensions

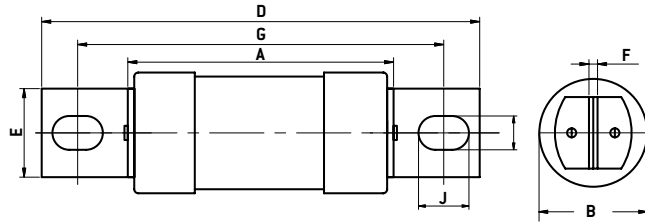

BS REF	FUSE TYPE	CURRENT RATING (A)	DIMENSIONS (MM)							
			A MAX	B MAX	D MAX	E MAX	F NOM	G NOM	H NOM	J NOM
B1	BTC	80, 100, 63M80, 63M100, 80M100	57	26.9	137	19.5	3.2	111	8.7	14
B2	BTF	125, 160, 200, 125M160, 125M200	73	41.9	138	19.5	3.2	111	8.7	14
B3	BTKF	250, 315	73	41.9	138	19.5	3.2	111	8.7	14
B4	BTMF	250, 315, 355, 400, 315M400	75	59.1	138	26	4.8	111	8.7	14

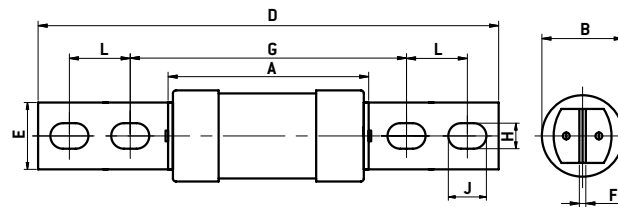

BS REF	FUSE TYPE	CURRENT RATING (A)	DIMENSIONS (MM)								
			A MAX	B MAX	D MAX	E MAX	F NOM	G NOM	H NOM	J NOM	L NOM
C1	BTM	250, 315, 355, 400	75	59.1	212	26	4.8	133	10.3	16	25.4
C2	BTTM	450, 500, 560, 630	83	74.4	212	26	6.3	133	10.3	16	25.4
C3	BTLM	670, 710, 750, 800	86	82.4	212	26	9.5	133	10.3	16	25.4

Electrical characteristics

FUSE TYPE	CURVE TYPE	CURRENT RATING (A)	I ² T (AMPERE ² SECONDS)		WATT LOSS
			PRE ARCING	TOTAL	
BTC	gG	80	8500	48500	6.5
BTC	gM	63M80	8500	48500	5.1
BTC	gG	100	14000	80000	7.5
BTC	gM	63M100	14000	80000	4.7
BTC	gM	80M100	14000	80000	6
BTF	gG	125	28000	140000	11.3
BTF	gG	160	60000	300000	14.5
BTF	gM	125M160	60000	300000	11.3
BTF	gG	200	105000	350000	16.2
BTF	gM	125M200	105000	350000	10.1
BTMF/BTM/BTKF	gG	250	190000	700000	24
BTMF/BTM/BTKF	gG	315	270000	1350000	31
BTMF/BTM	gG	355	395000	1975000	32
BTMF/BTM	gG	400	505000	2525000	38
BTMF	gM	315M400	505000	2525000	30
BTTM	gG	450	650000	3300000	42
BTTM	gG	500	850000	4250000	48
BTTM	gG	560	1200000	5800000	50
BTTM	gG	630	1546000	9800000	54
BTLM	gG	670	1950000	10100000	60
BTLM	gG	710	2400000	12000000	62
BTLM	gG	750	3000000	14200000	65
BTLM	gG	800	3769000	15000000	68

TIME VS. CURRENT CHARACTERISTICS

gG Curves - 2 to 800A - 690 V ac

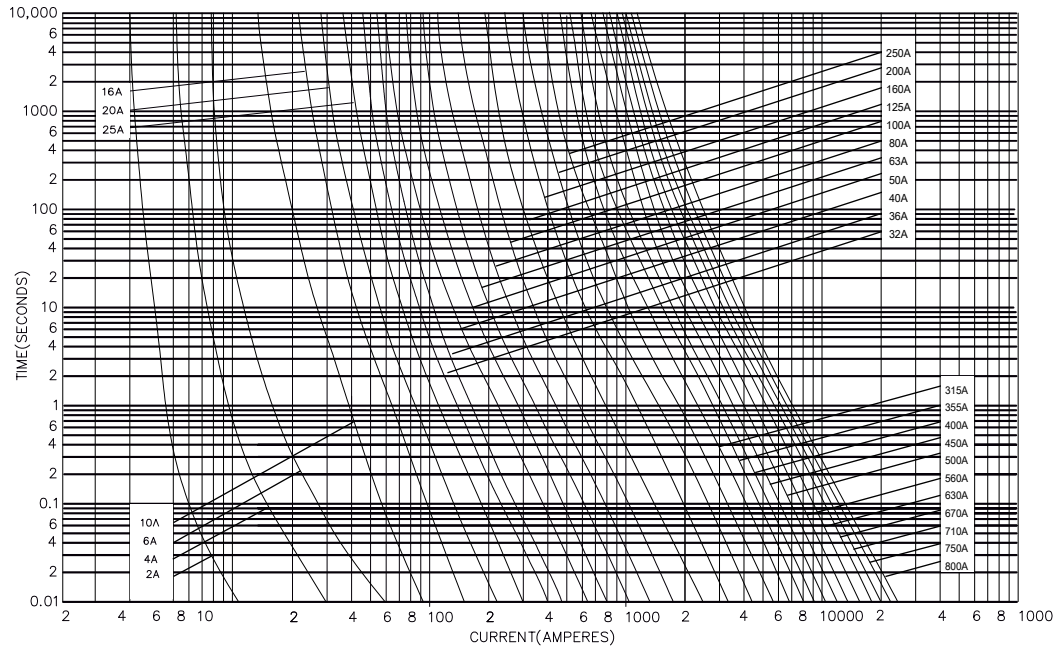

gM Curves - 10M16 to 315M400A - 690 V ac

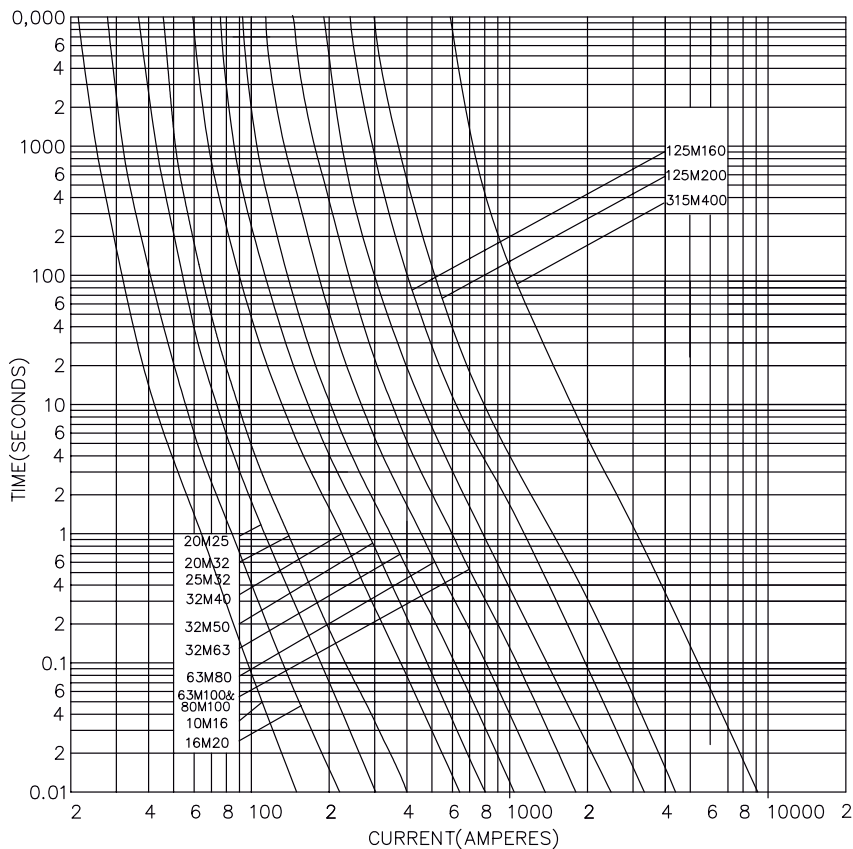

CUT-OFF CURRENT CHARACTERISTICS

A, B, C, & F - Type 550/690 V ac

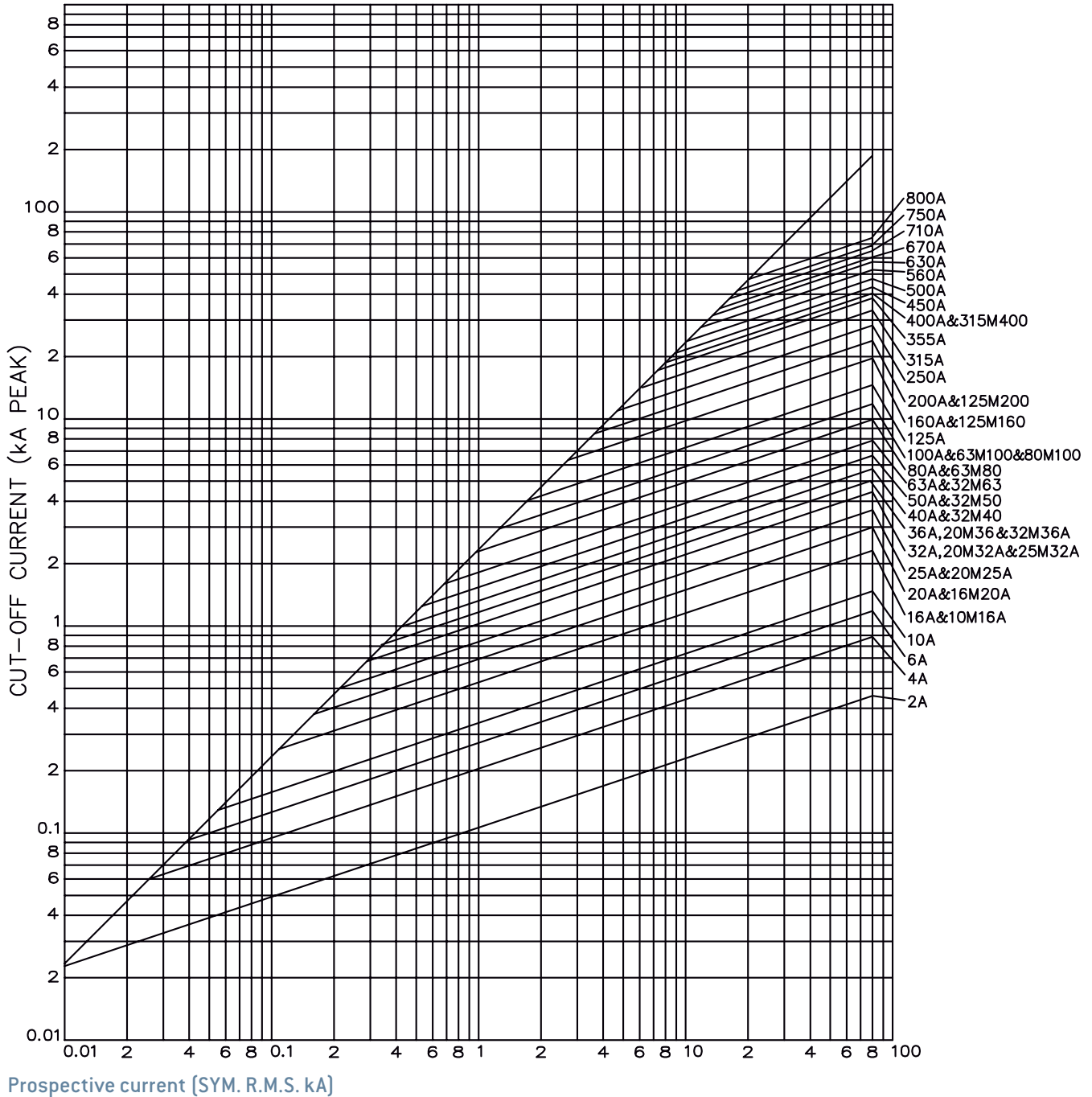

I²T CHARACTERISTICS

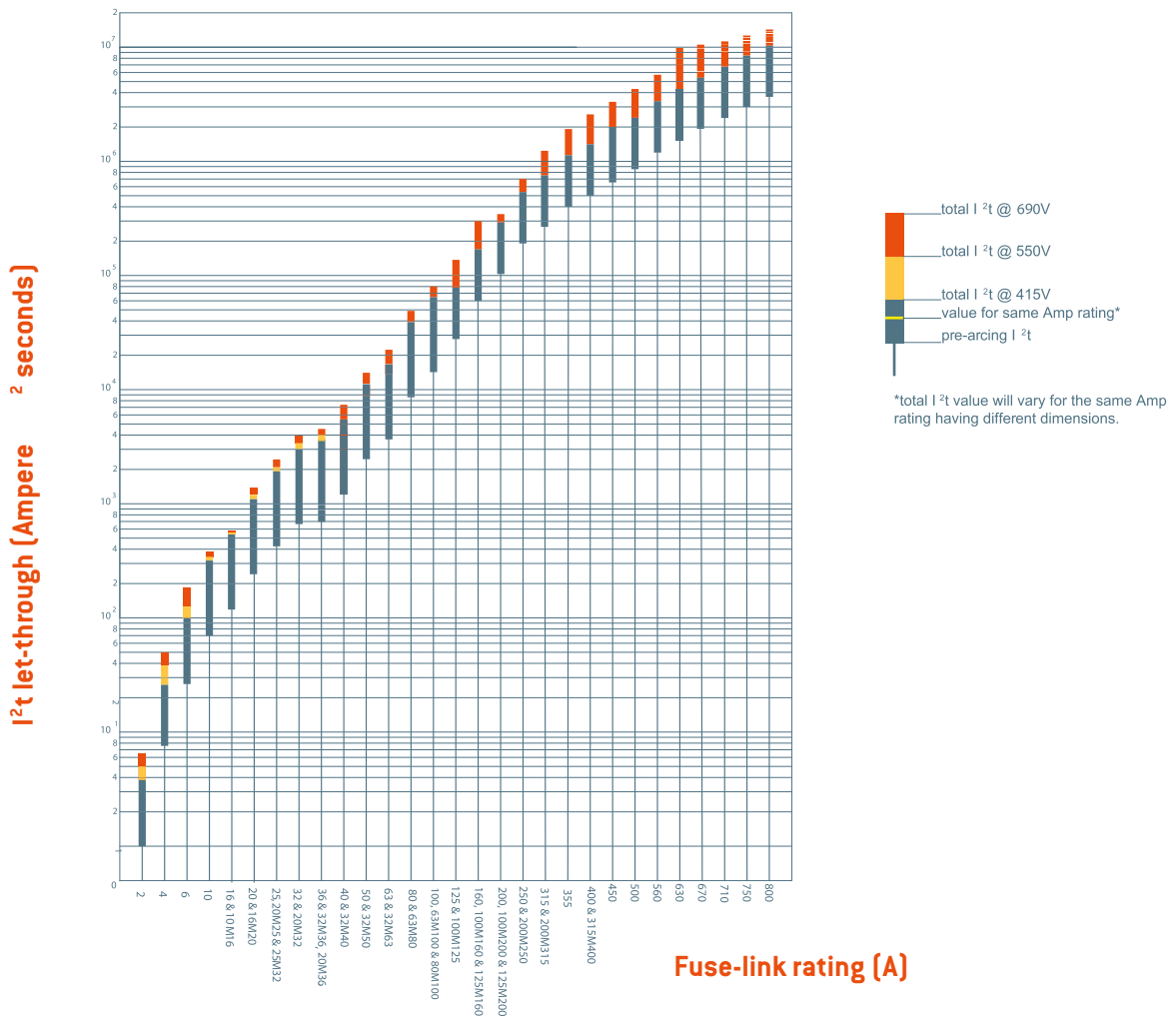

Power dissipation charte

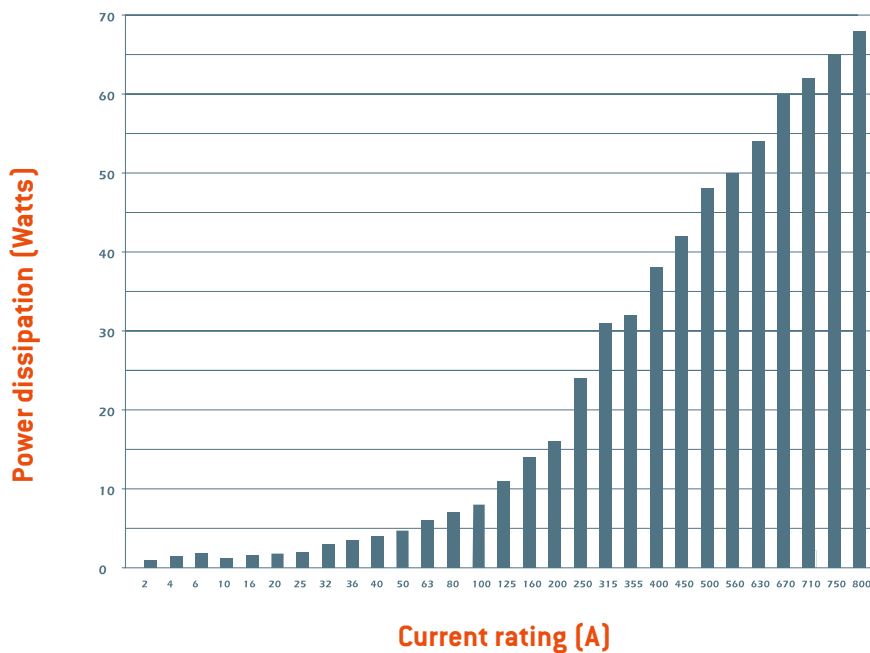

APPLICATION INFORMATION

Voltage rating selection

BS88 fuses comply with IEC 60269 standards. They are tested under a voltage at least 10% higher than the fuse rated voltage.

Ambient temperature

Above an ambient of 40°C a general de-rating of 0.5% of the fuse-link rated current per excess degree centigrade is recommended.

Cable protection

gG fuses protect cables against both overload and short circuit. The cable is protected when the following conditions are fulfilled.

$$I_B \leq I_N \leq I_z$$

$$I_F \leq 1.45I_z$$

I_B : Operating current of the cable

I_z : Maximum current carrying capacity of the cable

I_N : Rated current of the fuse

I_F : Conventional fusing current of the fuse

Capacitor circuit protection

The fuse selection must take into account:

- The inrush current occurring when the capacitor is switched on.
- The harmonic currents during the normal operation of the network.
- Capacitor tolerances.

The fuse link should be chosen with a current rating greater than 1.7 times the rated capacitor current. Correction for ambient temperature higher than 40°C must be added.

Transformer protection

Fuses must be fitted both in the primary and the secondary of the transformer. The fuse selection must take into account the high transient inrush current in the primary of the transformer. Consequently the normal current rating of the fuse links on the primary side of transformers should be at least twice the nominal transformer primary current. The normal I_n value of the fuse links on the secondary side of transformers is at least equal to the nominal transformer secondary current when the temperature does not exceed 40°C.

Motor circuit protection

The motor starter manufacturers generally recommend the fuse link rating to be used in conjunction with the motor starter. Type 2 co-ordination is easily obtained with Mersen fuses in view of having the pre-arcing I^2t values closer to the lower limit of the specified limits of the standard. The gM fuse selection as for an aM fuse requires the melt current at 5 seconds is 7 times the fuse rating.

Protection against electrical shock

The rule is to disconnect within a time specified by local standards. Generally wiring regulations require a disconnecting time not exceeding 5 seconds for a distribution circuit. It will be less than 1 second in many other cases. The maximum value of each fault loop impedance (Z_s) for gG fuse link for BS88: part 2 & 6 are as shown at 240V.

RATING (A)	Z_s (OHMS)
2	40.00
4	20.00
6	15.00
10	8.00
16	4.90
20	3.48
25	2.67
32	2.18
36	1.85
40	1.60
50	1.26
63	0.93
80	0.68
100	0.48
125	0.43
160	0.29
200	0.22
250	0.171
315	0.137
355	0.126
400	0.114
450	0.100
500	0.086
560	0.077
630	0.071
670	0.063
710	0.056
750	0.053
800	0.050

BS88 FUSE HOLDERS

For Offset Blade & Bolted Tag Fuse Links

For Offset Blade & Bolted Tag Fuse Links

Fuse holders from Mersen comply with BS88-1 and BS88-6: 1988. The fuse holders are designed to prevent direct contact with live parts when being inserted or removed, preventing any likelihood of inadvertent contact with live metal. Also, cable terminals within the fuse base are fully shrouded when holder is removed (product is IP2X Classified).

Type Of Connection



BFF Front wire connected
(front-front) 3 connection styles possible: Mounting on board with cable upstream and downstream



BBB Back stud connected
(back-back) Mounting on board with two cables on the back (connection via lug. see table)



BFB Front Back (busbar) stud connected Mounting on board with upstream or downstream cable and back cable



Advantage

1. DIN Rail Mounting for ease of assembly
2. Safety Shrouds
3. Options for colour and terminations
4. RoHs compliance



For Offset Blade & Bolted Tag Fuse Links

TYPE	VOLTAGE RATING (V)	NOMINAL CURRENT (A)	COLOR	CONNECTION	REFERENCE NUMBER	CATALOGUE NUMBER	STANDARD PACK	MERSEN USE/NEUTRAL LINK TYPE
F1	550	32	Black	Front-Front	A230138F	BFF32F1	6	BNS55Vxx
F1	550	32	Black	Back-Back	N239120F	BBB32F1	6	
F1	550	32	Black	Front-Back	B230139F	BFB32F1	6	
F1	550	32	Green	Front-Front	B1012553F	BFF32F1G	6	
F1	550	32	Green	Back-Back	V1012547F	BBB32F1G	6	
F1	550	32	Green	Front-Back	Y1012550F	BFB32F1G	6	
F1	550	32	White	Front-Front	P239121F	BFF32F1W	6	BNEUTRALF1
F1	550	32	White	Back-Back	Q239122F	BBB32F1W	6	
F1	550	32	White	Front-Back	R239123F	BFB32F1W	6	
F1	550	32	-	-	D239134J	BNEUTRALF1	10	-
F2	550	63	Black	Front-Front	S239124F	BFF63F2	6	BES55Vxx BES42Vxx
F2	550	63	Black	Back-Back	T239125F	BBB63F2	6	
F2	550	63	Black	Front-Back	V239126F	BFB63F2	6	
F2	550	63	Green	Front-Front	Z239130F	BFF63F2G	6	
F2	550	63	Green	Back-Back	A239131F	BBB63F2G	6	
F2	550	63	Green	Front-Back	B239132F	BFB63F2G	6	
F2	550	63	White	Front-Front	W239127F	BFF63F2W	6	BNEUTRALF2
F2	550	63	White	Back-Back	X239128F	BBB63F2W	6	
F2	550	63	White	Front-Back	Y239129F	BFB63F2W	6	
F2	550	63	-	-	E239135J	BNEUTRALF2	10	-
A1	550	32	Black	Front-Front	D239088F	BFF32A1	6	BNIT55Vxx
A1	550	32	Black	Back-Back	E239089F	BBB32A1	6	
A1	550	32	Black	Front-Back	F239090F	BFB32A1	6	
A1	550	32	Green	Front-Front	K239094F	BFF32A1G	6	
A1	550	32	Green	Back-Back	L239095F	BBB32A1G	6	
A1	550	32	Green	Front-Back	M239096F	BFB32A1G	6	
A1	550	32	White	Front-Front	G239091F	BFF32A1W	6	BNEUTRALA1
A1	550	32	White	Back-Back	H239092F	BBB32A1W	6	
A1	550	32	White	Front-Back	J239093F	BFB32A1W	6	
A1	550	32	-	-	F239136J	BNEUTRALA1	10	-
A2	690	32	Black	Front-Front	C230140F	BFF32A2	6	BTIA55Vxx BTIA69Vxx
A2	690	32	Black	Back-Back	P1012542F	BBB32A2	6	
A2	690	32	Black	Front-Back	D230141F	BFB32A2	6	
A2	690	32	Green	Front-Front	Z1012551F	BFF32A2G	6	
A2	690	32	Green	Back-Back	S1012545F	BBB32A2G	6	
A2	690	32	Green	Front-Back	W1012548F	BFB32A2G	6	
A2	690	32	White	Front-Front	A1012552F	BFF32A2W	6	BNEUTRALA2
A2	690	32	White	Back-Back	T1012546F	BBB32A2W	6	
A2	690	32	White	Front-Back	X1012549F	BFB32A2W	6	
A2	690	32	-	-	G239137J	BNEUTRALA2	10	-
A3	690	63	Black	Front-Front	F230143F	BFF63A3	6	BTSS42Vxx BTSDS42Vxx BTSDS42Vxxx BTIS69Vxx
A3	690	63	Black	Back-Back	V239103F	BBB63A3	6	
A3	690	63	Black	Front-Back	G230144F	BFB63A3	6	
A3	690	63	Green	Front-Front	Z239107F	BFF63A3G	6	
A3	690	63	Green	Back-Back	A239108F	BBB63A3G	6	
A3	690	63	Green	Front-Back	B239109F	BFB63A3G	6	
A3	690	63	White	Front-Front	W239104F	BFF63A3W	6	BNEUTRALA3
A3	690	63	White	Back-Back	X239105F	BBB63A3W	6	
A3	690	63	White	Front-Back	Y239106F	BFB63A3W	6	
A3	690	63	-	-	H239138J	BNEUTRALA3	10	-
A4	690	125	Black	Front-Front	H230145A	BFF125A4	1	BTSD42Vxxx BTCP42Vxxx BTCP69Vxxx
A4	690	125	Black	Back-Back	C239110A	BBB125A4	1	
A4	690	125	Black	Front-Back	J230146A	BFB125A4	1	
A4	690	125	Green	Front-Front	K239117A	BFF125A4G	1	
A4	690	125	Green	Back-Back	L239118A	BBB125A4G	1	
A4	690	125	Green	Front-Back	M239119A	BFB125A4G	1	
A4	690	125	White	Front-Front	D239111A	BFF125A4W	1	BNEUTRALA4
A4	690	125	White	Back-Back	E239112A	BBB125A4W	1	
A4	690	125	White	Front-Back	F239113A	BFB125A4W	1	
A4	690	125	-	-	J239139J	BNEUTRALA4	10	-

BS88 FUSE HOLDERS

Technical characteristics

SPECIFICATIONS	F1	F2	A1	A2	A3	A4
3 kinds of electrical connections in Black White & Green						
Front connected	BFF32F1	BFF63F2	BFF32A1	BFF32A2	BFF63A3	BFF125A4
Back connected	BBB32F1	BBB63F2	BBB32A1	BBB32A2	BBB63A3	BBB125A4
Front Back connected	BFB32F1	BFB63F2	BFB32A1	BFB32A2	BFB63A3	BFB125A4
Cable cross-section for font connection						
Min: 1 or 2 cables	1 mm ²	1 mm ²	1 mm ²	1 mm ²	1 mm ²	1 mm ²
Max: 1 cable	16 mm ²	25 mm ²	16 mm ²	16 mm ²	50 mm ²	70 mm ²
Max: 2 cables	10 mm ²	16 mm ²	10 mm ²	10 mm ²	25 mm ²	35 mm ²
Type of wire to be used: Copper multi strand or single strand Note: Multistrand cable with maximum 17 strands. For more than 17 strands a circular sleeve at the end of the cable is compulsory						
Lug diameter of the cable for Back & Busbar connection terminal diameter (refer Note)	M6	M8	M6	M6	M8	M8
DIN Rail Mounting	35 mm DIN Rail					
Whether the plastic material complies with RoHS	Thermoplastic Polyamid, RoHS compliant & Fire Retardant					
Diameter of the screw to be used for panel mounting Deep base = 4mm	M5 screw (Pan head/Cheese head)					
Max torque for the mounting screw on the panel	3.5 Nm	4 Nm	3.5 Nm	4 Nm	3.5 Nm	4 Nm
Max torque for the grub screw (back & bus bar connections)	3.5 Nm	4 Nm	3.5 Nm	3.5 Nm	3.5 Nm	4 Nm
Certification	ASTA					
Rated Voltage	550 V AC 250 V DC	550 V AC	550 V AC 250 V DC	690 V AC 460 V DC	690 V AC 460 V DC	690 V AC 460 V DC
Rated Current	32 A	63 A	32 A	32 A	63 A	125 A
Rated peak withstand current @ rated voltage	80 kA					
Tool specification for tightening Electric Screw driver / Manual crew driver - Max Torque setting	3.5 Nm	4 Nm	3.5 Nm	4 Nm	4 Nm	4 Nm
Screwdriver bit	Diameter 6 x 100mm					
with working edge thickness of 1mm and width of 7mm	0.8 x 4.8 mm	1 x 6 mm	0.8 x 4.8 mm	1 x 6 mm	1 x 6 mm	1 x 6 mm
U imp according to IEC 60269-1	8 kA					

Dimensions for F type

Front Front Connection (BFF)

Back Back Connection (BBB)

Front Back (Busbar) Connection (BFB)

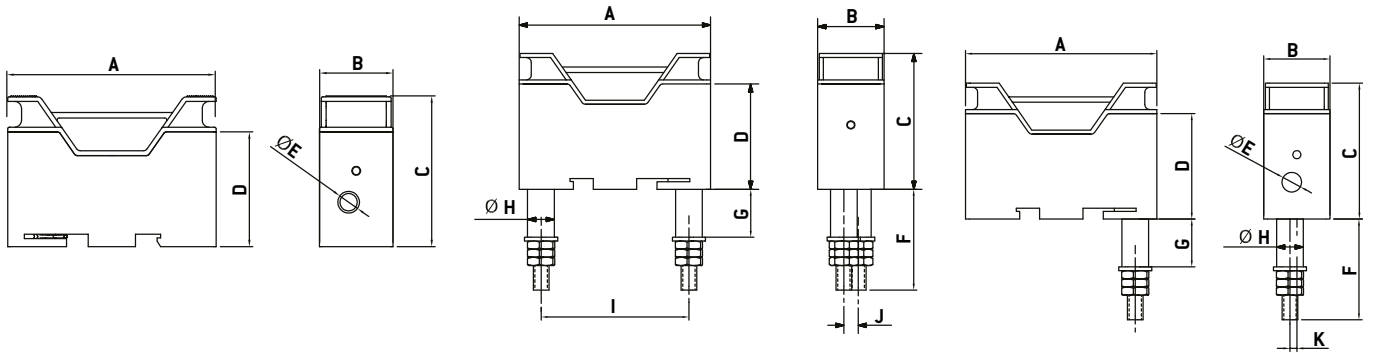

FUSE HOLDER TYPE	A	B	C	D	E	F	G	H	I	J	K
BFF32F1	75.5	26.5	54	41.5	7.8	-	-	-	-	-	-
BBB32F1	75.5	26.5	54	41.5	-	40	17	9.7	58	5.6	-
BFB32F1	75.5	26.5	54	41.5	7.8	40	17	9.7	-	-	2.7
BFF63F2	89	28.5	64	48.6	9	-	-	-	-	-	-
BBB63F2	89	28.5	64	48.6	-	39	18.3	12	67	7	-
BFB63F2	89	28.5	64	48.6	9	39	18.3	12	-	-	3.3

Panel Drilling Dimensions

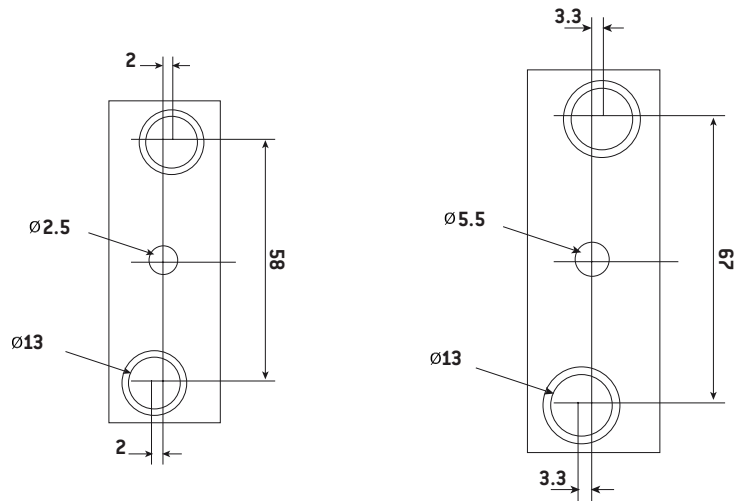

For F1

For F2

BS88 FUSE HOLDERS

Dimensions for A type

Front Front Connection (BFF)

Back Back Connection (BBB)

Front Back (Busbar) Connection (BFB)

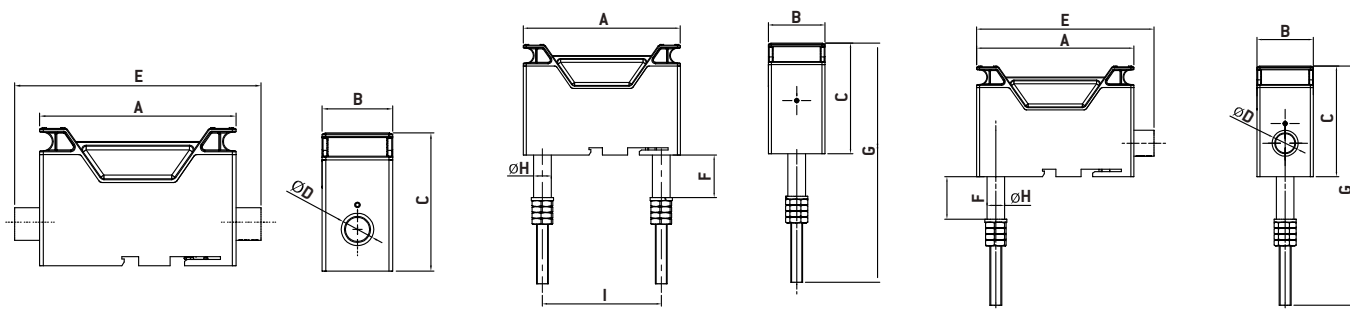

FUSE HOLDER TYPE	A	B	C	D	E	F	G	H	I
BFF32A1	77.2	27.5	57	9	97.2	-	-	-	-
BBB32A1	77.2	27.5	57	-	-	28.6	122	11.9	58
BFB32A1	77.2	27.5	57	9	87.2	28.6	122	11.9	-
BFF32A2	99.8	33	56	9	119.8	-	-	-	-
BBB32A2	99.8	33	56	-	-	28.6	122	11.9	76.1
BFB32A2	99.8	33	56	9	109.8	28.6	122	11.9	-
BFF63A3	105.8	38	74.5	17.5	132.8	-	-	-	-
BBB63A3	105.8	38	74.5	-	-	28.6	161	11.9	80
BFB63A3	105.8	38	74.5	17.5	119.3	28.6	161	11.9	-
BFF125A4	134	48.9	97.8	17.5	165.7	-	-	-	-
BBB125A4	134	48.9	97.8	-	-	28.6	184.4	11.9	94.1
BFB125A4	134	48.9	97.8	17.5	149.9	28.6	184.4	11.9	-

Panel Drilling Dimensions

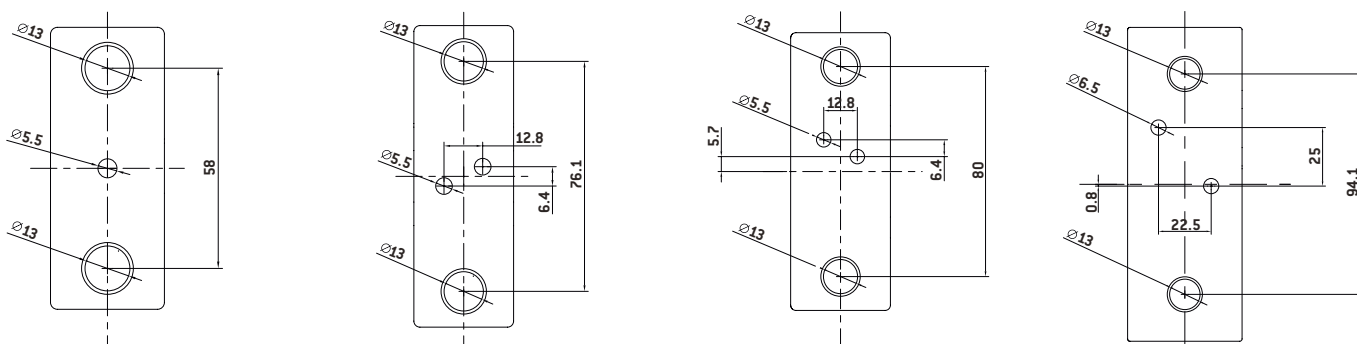

For A1

For A2

For A3

For A4

For Offset Blade - Phenolic Type

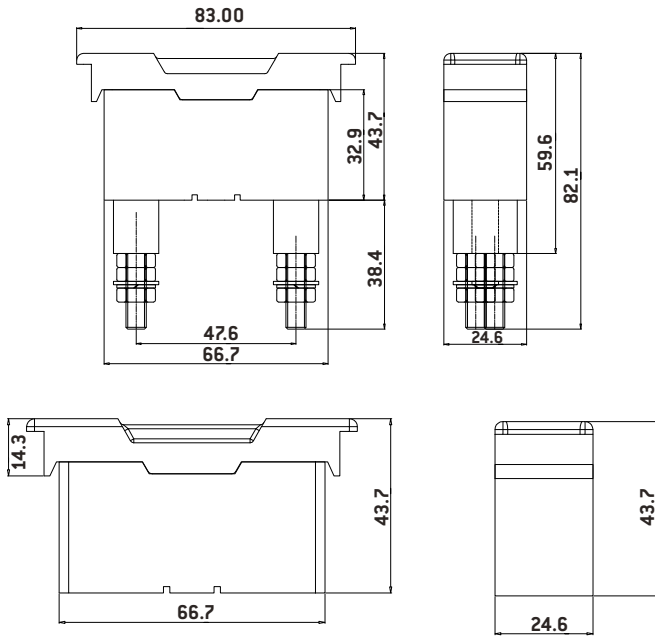

TYPE	VOLTAGE RATING (V)	NOMINAL CURRENT (A)	COLOR	CONNECTION	REFERENCE NUMBER	CATALOGUE NUMBER	STANDARD PACK	MERSEN FUSE TYPE
F1	550	32	Black	Front-Front	T1036995F	BNSH32F1	6	BNS55Vxx
F1	550	32	Black	Back-Back	W1036297F	BNSP32F1	6	

TYPE	VOLTAGE RATING (V)
Front connected	BFF32F1
Back connected	BBB32F1
Cable cross-section for front connection	
Min: 1 or 2 cables	1 mm ²
Max: 1 cable	16 mm ²
Max: 2 cables	10 mm ²
Type of wire to be used: Copper multi strand or single strand Note: Multistrand cable with maximum 17 strands. For more than 17 strands a circular sleeve at the end of the cable is compulsory	
Lug diameter of the cable for Back & Busbar connection terminal diameter (refer Note)	M6
Diameter of the screw to be used for panel mounting Deep base = 4mm	M5 screw (Pan head/Cheese head)
Max torque for the mounting screw on the panel	3.5 Nm
Max torque for the grub screw (back & bus bar connections)	3.5 Nm
Rated Voltage	550 V AC
Rated Current	32 A
Rated peak withstand current @ rated voltage	80 kA
Tool specification for tightening Electric Screw driver / Manual crew driver - Max Torque setting	3.5 Nm
Screwdriver bit	Diameter 6 x 100mm
with working edge thickness of 1mm and width of 7mm	0.8 x 4.8 mm
U imp according to IEC 60269-1	8 kV

ASTA
CERTIFICATE OF SHORT-CIRCUIT RATING
 Laboratory Ref. No. **8200506** Certificate No. **16535**

APPARATUS: Low Voltage 10kV Fuses, which represented the maximum and minimum ratings of a homogeneous series.
 Rated voltage 10kV, Rated current 20 kA, Maximum I_{sc} 20kA

DESIGNATION: 2T1 - 6T1 and 2T1 - 6T1

MANUFACTURER: Carbone Lorraine India Private Limited, Feroz Shereef Division, A-2, E3348 Industrial Estate, G23, Sector 14A, Faridkot, Punjab - 141 005, India

TESTED BY: Central Power Research Institute, Switchgear Testing & Development Station, Shree-402 023, Madhya Pradesh, India.

DATE OF TESTS: 07 & 10th October 2006

The apparatus, constructed in accordance with the description, drawings and photographs incorporated in this certificate has been subjected to the series of proving tests in accordance with:

IEC 60289-1:2005, IEC 60289-2-1:2004, BS EN 60289-1:2005 (incorporating Amendment 1: 2005), BS EN 60289-2:1995 (incorporating Amendment 1), BS 88: Part 1: 1988 (incorporating Amendment No. 1 & 2), BS 88-2-1: 1988 (incorporating Amendment No. 1 & 2) and BS 88-2-2: 1988 (incorporating Amendment No. 1, 2 & 3) Class No. 8.5.

The results are shown in the record of Proving Tests and the certificates attached hereto. The values obtained and the general performance are considered to comply with the above standard(s) and to justify the ratings assigned by the manufacturer as stated below.

Breaking Range and Utilization Category: gG

Rated Breaking Capacity: 80kA at 10kVac.

1. The above data does not represent the maximum and minimum (MCM) ratings of a homogeneous series with a high voltage fuse link having an intended energy (W) value exceeding 200000 J and a rated current (I_n) of 10 kA or above for any of the series.

The record of Proving Tests applies only to the apparatus tested. The responsibility for conformity of any apparatus having the same designations with that tested rests with the manufacturer.

This Certificate comprises: 11 pages, 2 diagrams, 22 photographs, 3 photographs, 3 drawings and no other sheets included on page 3.

Only integral reproduction of this Certificate or reproduction of this page accompanied by any printed or electronic copies of the original rated characteristics of the apparatus tested, are permitted without written permission from ASTA, 80/80 Certification Services, Nilton House, Corporation Street, Rugby, CV21 2JN, England.

 Rajan Menon
ASTA Observer

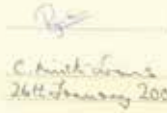
 DIRECTOR
26th January 2007 Date

ASTA
CERTIFICATE OF SHORT-CIRCUIT RATING
 Laboratory Ref. No. **8200502** Certificate No. **16524**

APPARATUS: Low Voltage 10kV Fuses, which represented the maximum and minimum ratings of a homogeneous series.
 Rated voltage 10kV, Rated current 20 kA, Maximum I_{sc} 20kA

DESIGNATION: 10A3 to 10A5, 10MMA3, 10MMA2 & 10MMA1, 10A(C)10A(C)

MANUFACTURER: Carbone Lorraine India Private Limited, Feroz Shereef Division, A-2, E3348 Industrial Estate, G23, Sector 14A, Faridkot, Punjab - 141 005, India

TESTED BY: Central Power Research Institute, Switchgear Testing & Development Station, Shree-402 023, Madhya Pradesh, India.

DATE OF TESTS: 07th, 11th, 12th & 13th October 2006

The apparatus, constructed in accordance with the description, drawings and photographs incorporated in this certificate has been subjected to the series of proving tests in accordance with:

IEC 60289-1:2005, IEC 60289-2-1:2004, BS EN 60289-1:2005 (incorporating Amendment 1: 2005), BS EN 60289-2:1995 (incorporating Amendment 1), BS 88: Part 1: 1988 (incorporating Amendment No. 1 & 2), BS 88-2-1: 1988 (incorporating Amendment No. 1 & 2) and BS 88-2-2: 1988 (incorporating Amendment No. 1, 2 & 3) Class No. 8.5.

The results are shown in the record of Proving Tests and the certificates attached hereto. The values obtained and the general performance are considered to comply with the above standard(s) and to justify the ratings assigned by the manufacturer as stated below.

Breaking Range and Utilization Category: gG & gM

Rated Breaking Capacity: 80kA at 10kVac.

1. The above data does not represent the maximum (MCM) ratings of a homogeneous series with a high voltage fuse link having an intended energy (W) value exceeding 200000 J and a rated current (I_n) of 10 kA or above for any of the series.

The record of Proving Tests applies only to the apparatus tested. The responsibility for conformity of any apparatus having the same designations with that tested rests with the manufacturer.

This Certificate comprises: 12 pages, 2 diagrams, 22 photographs, 3 photographs, 3 drawings and no other sheets included on page 3.

Only integral reproduction of this Certificate or reproduction of this page accompanied by any printed or electronic copies of the original rated characteristics of the apparatus tested, are permitted without written permission from ASTA, 80/80 Certification Services, Nilton House, Corporation Street, Rugby, CV21 2JN, England.

 Rajan Menon
ASTA Observer

 DIRECTOR
26th January 2007 Date

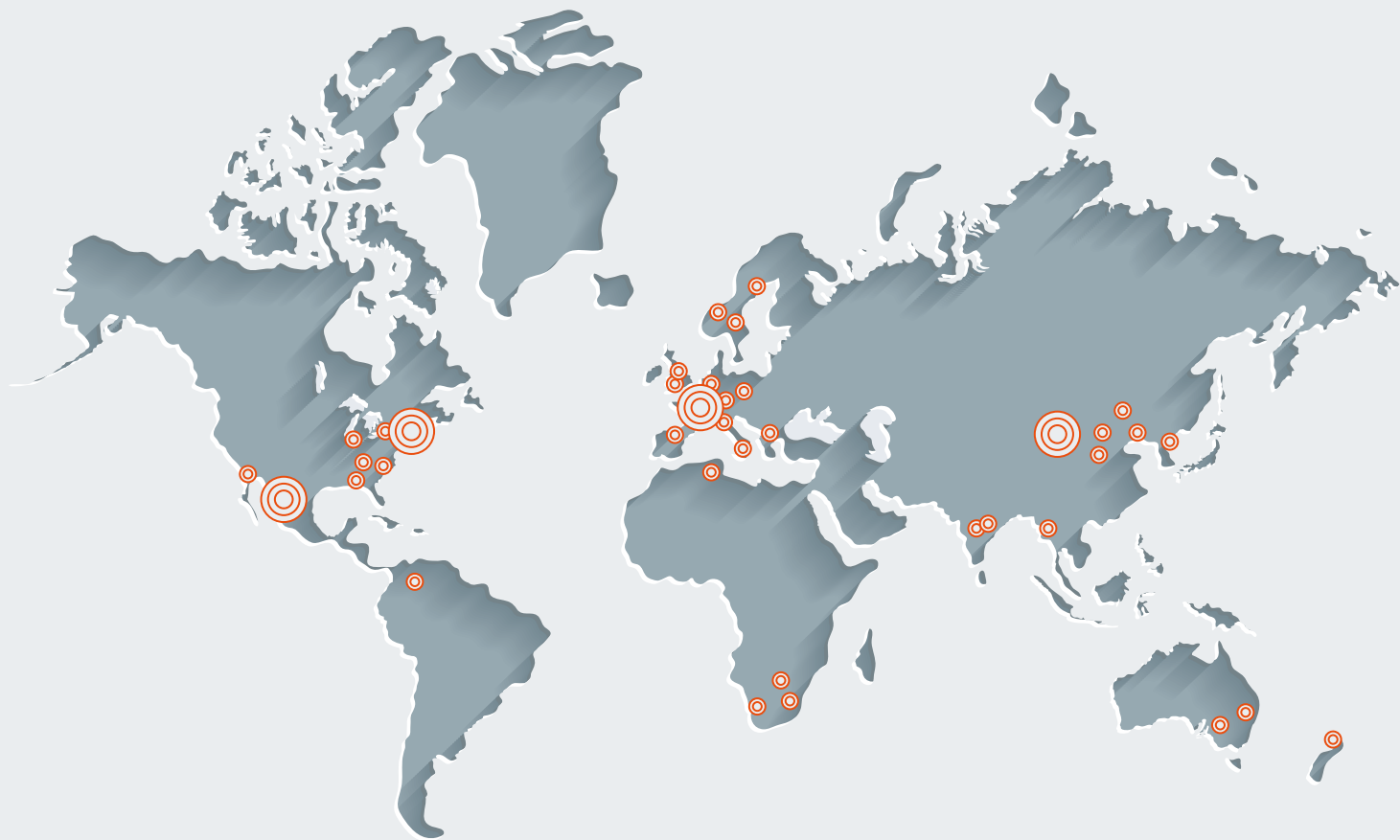

GLOBAL EXPERT
IN ELECTRICAL POWER
AND ADVANCED MATERIALS.

NORTH AMERICA

USA
Mersen USA
Newburyport-MA L.L.C.
374 Merrimac Street
Newburyport, MA 01950
Tel: +1 978-462-6662

EUROPE

FRANCE
Mersen France SB S.A.S.
Rue Jacques de Vaucanson
F-69720 Saint-Bonnet-de-Mure
Tel: + 33 4 72 22 66 11

UNITED KINGDOM
Mersen UK Portslade Ltd.
South Street
Portslade, East Sussex
BN41 2LX
Tel: +44(0) 1273 415701
sales.ep.uk@mersen.com

ASIA

INDIA
Mersen India Pvt. Ltd.
19, 4th Cross,
Bommasandra Industrial Area,
Bangalore - 560099
Tel: +91 80 27834001/5/6
E-mail: sales.ep.india@mersen.com



EP.MERSEN.COM