

Bourdon tube pressure gauges, liquid filled,

Modelcode type: 213.53.0XX

Item number: 82449611

Description

Design according	EN 837-1
Accuracy class	class 1.6
Scale range	0...2.5 MPa
2nd Scale or Special Scale	2nd scale psi

Constructional design

Process connection	1/4 NPT
Connector location	back mount
Pressure element	Copper alloy
Movement	Copper alloy
Case	Crimp ring case (version 53)
Nominal size	063 mm
Case filling fluid	glycerine
Pointer	plastic, black (double division)
Window	plastic, clear
Dial	plastic, white, with stop-pin

Options

Mounting flange/bracket	narrow panel ring, SS,rolled on,with mounting bracket
Thread protection	with thread protection

Operating conditions

Pressure limitation	Steady: 3/4 x full scale value Fluctuating: 2/3 x full scale value Short time: Full scale value
Permissible ambient temperature	-20 ... +60 °C
Permissible medium temperature	+60°C maximum
Temperature effect when the temperature deviates from the reference temperature (+20°C)	Max. +/-0.4 %/10 K of the span
Ingress protection	IP 65

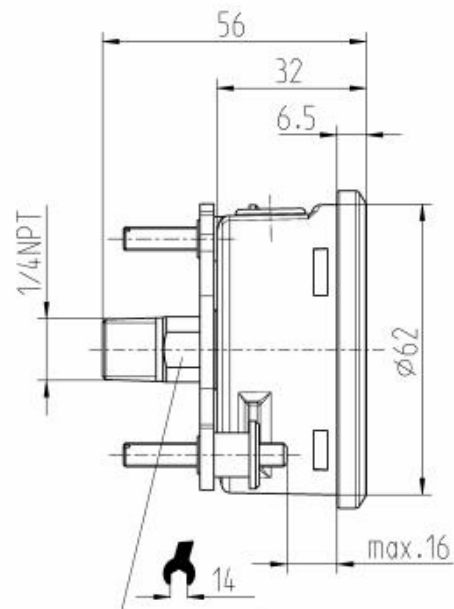
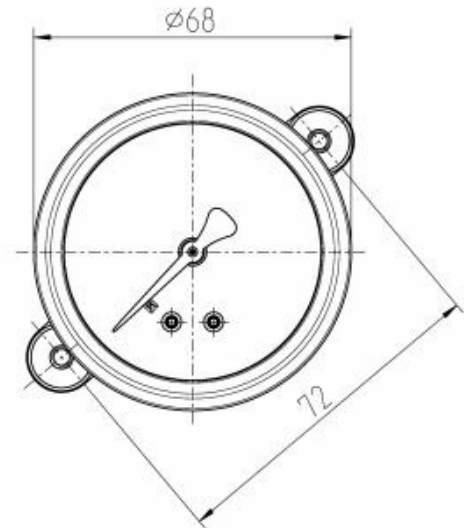

Bourdon tube pressure gauges, liquid filled,

Modelcode type: 213.53.0XX

Item number: 82449611

Dial description:

Pressure Gauge Standard	China
color for 1.scale (outside)	black
color for 2.scale (inside)	red RAL 3020
dial background	White
Manufacturer logo	*WIKA*
stop pin on dial	at zero
norm-mark on dial	*EN 837-1*
safetymark on dial	*S*
accuracy class on dial	*Cl.1.6*

Labelcode

Label	WIKA standard
language of the label	German