

# CHROME

BUSSOLE E ACCESSORI CHROME  
*CHROME sockets and accessories*

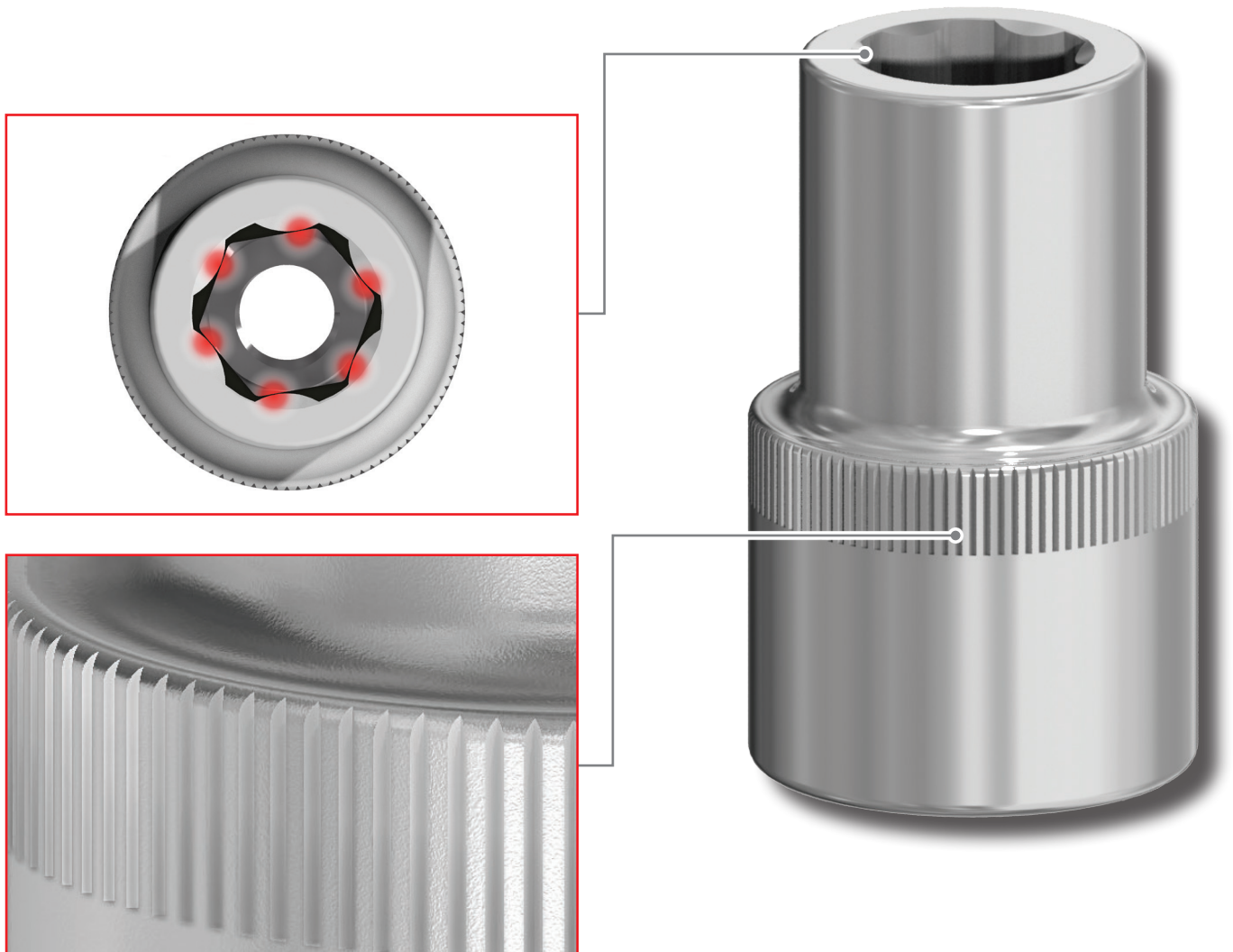

Realizzate in acciaio al Cromo Vanadio di alta qualità. Collare godronato per una miglior presa e resistente rivestimento superficiale di cromatura.

*Made in high quality Chrome-Vanadium steel. Knurled collar for better grip and resistant chrome-plated surface coating.*



Impronta esagonale tipo SUPER- LOCK: il contatto con il dado non avviene sullo spigolo ma sulla faccia dell'esagono, che offre una maggior superficie di appoggio.

*SUPER-LOCK hex tip: the contact with the nut does not take place on the edge, but on the face of the hexagon, which offers a larger support surface.*



Indicate per applicazioni manuali in ambito professionale.

*Suitable for professional manual applications.*

**64230**

# TROLLEY UTENSILI MANUALI CON BUSSOLE E ACCESSORI 1/4" 3/8" 1/2"

**TROLLEY 179 PCS. UTENSILI ASSORTITI PER PROFESSIONISTI**  
**TROLLEY WITH 179 ASSORTED TOOLS FOR PROFESSIONALS**

179  
pcs.

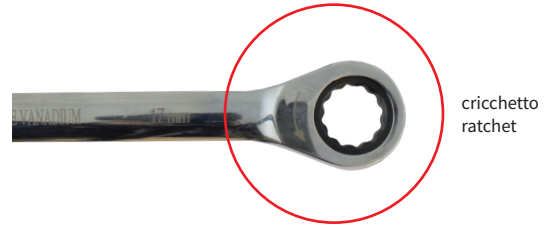

cricchetto  
ratchet



470 X 380 X 210 mm





**FOCUS ON**



Valigetta con quattro vassoi interni completi di tutti gli utensili necessari al lavoro dei professionisti di tutti i settori, in un robusto trolley resistente agli urti.

Case with four internal trays complete with all the tools necessary for the work of professionals in all sectors, in a robust shock-resistant trolley.

COD. **64230304**

	3,0 4,0 5,0 7,0
	PH0 PH1 PH2 PH3
	PZ0 PZ1 PZ2 PZ3
	TX8 TX9 TX10 TX15 TX20 TX25 TX27 TX30 TX40
	1,5 2 2,5 3 4 5 5,5 6 8
	4 4,5 5 5,5 6 7 8
	9 10 11 12 13
	10 11 12 13 14 15 16
	17 18 19 20 21 22 24
	8 10 11 12 13 14 17 19 22
	1,5 2 2,5 3 4 5 6 8 10
	1/4" 1/4" 50 100  1/4" 1/4" 40
	1/2" 1/2" 125 250  1/2" 1/2" 80
	1/4" 16
	1/2" 21
	1/4"  1/2"  3/8"  1/4" C  1/4"

	1/4" C  1/4" E		1/4" C		1/4"
	6x75  6x100  8x150		6		L=38mm  PH2
	LED		TESTER 250V		
	200mm		180mm		
	160mm		10 pcs		
	160mm		180mm		
	160mm		300mm		
	200mm		3 pcs		
	5 pcs		300gr		
	5m		200mm		
	200mm		50 pcs		

# SCHEDE TECNICHE TECHNICAL DATASHEETS

**PHILLIPS®**

A REGISTERED TRADEMARK OF PHILLIPS SCREW COMPANY



IN ACCORDO A NORME INTERNAZIONALI  
IN ACCORDANCE WITH INTERNATIONAL STANDARDS

COPPIA DI TORSIONE SECONDO NORME  
TIGHTENING TORQUE IN ACCORDANCE WITH THE STANDARDS

**DIN 5260  
ISO 8764**

**DIN 5261\*  
ISO 8764\***

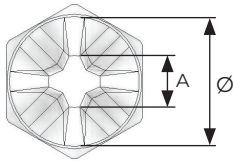
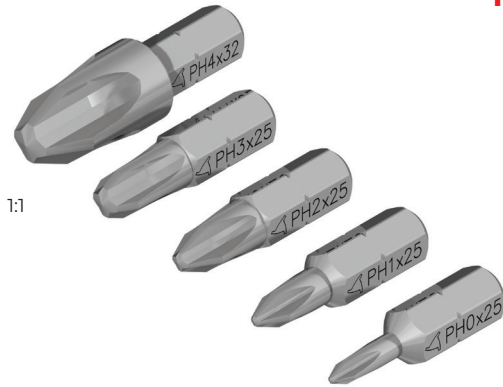

+	A	Ø	Nm	Nm	Autofilettanti per metallo Self-tapping for metal			Autofilettanti per legno Self-tapping for wood			Metriche Metrics			
					ISO 7049 = DIN 7981	ISO 7050 = DIN 7982	ISO 7051 = DIN 7983	DIN 7996	DIN 7997	DIN 7995	ISO 7045 = DIN 7985	ISO 7046 = DIN 965	ISO 7047 = DIN 966	
<b>PH0</b>	0,84	3	1,0	1,0	2,2	2,2	2,2	2,0	2,0	2,0	2,0	2,0	2,0	2,0
<b>PH1</b>	1,30	4,5	3,5	3,8	2,2 2,9	2,2 2,9	2,2 2,9	2,5 3,0	2,5 3,0	2,5 3,0	2,5 3,0	2,5 3,0	2,5 3,0	2,5 3,0
<b>PH2</b>	2,31	6	8,2	10,3	3,5 4,8	3,5 4,8	3,5 4,8	3,5 5,0	3,5 5,0	3,5 5,0	4,0 5,0	4,0 5,0	4,0 5,0	4,0 5,0
<b>PH3</b>	3,84	8	19,5	32,0	5,5 6,3	5,5 6,3	5,5 6,3	5,5 7,0	5,5 7,0	5,5 7,0	6,0	6,0	6,0	6,0
<b>PH4</b>	5,11	10	38,0	88,7	8,0 9,5	8,0 9,5	8,0 9,5	8,0	8,0	8,0	8,0 10,0	8,0 10,0	8,0 10,0	8,0 10,0

\* LE NORME PREVEDONO CHE SOTTO IL VALORE DI COPPIA INDICATA IL PROFILO DELL'UTENSILE NON PRESENTI ALCUNA DEFORMAZIONE

\* THE STANDARDS REQUIRE THAT THE TOOL PROFILE DOES NOT DEFORM UNDER THE INDICATED TORQUE VALUES

# SCHEDE TECNICHE TECHNICAL DATASHEETS

**POZIDRIV®**

A REGISTERED TRADEMARK OF PHILLIPS SCREW COMPANY



IN ACCORDO A NORME INTERNAZIONALI  
IN ACCORDANCE WITH INTERNATIONAL STANDARDS

COPPIA DI TORSIONE SECONDO NORME  
TIGHTENING TORQUE IN ACCORDANCE WITH THE STANDARDS

**DIN 5260  
ISO 8764**

**DIN 5261\*  
ISO 8764\***

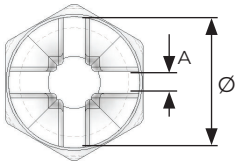
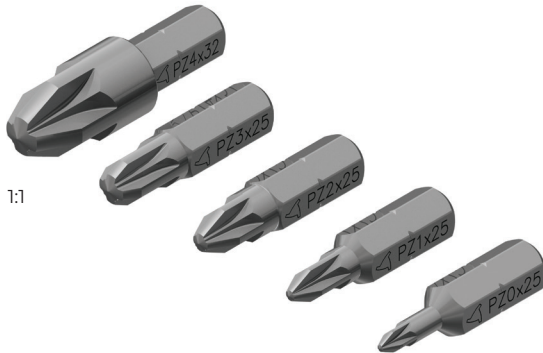

+	A	Ø	Nm	Nm	Autofilettanti per metallo Self-tapping for metal			Autofilettanti per legno Self-tapping for wood			Metriche Metrics		
					ISO 7049 = DIN 7981	ISO 7050 = DIN 7982	ISO 7051 = DIN 7983	DIN 7996	DIN 7997	DIN 7995	ISO 7045 = DIN 7985	ISO 7046 = DIN 965	ISO 7047 = DIN 966
<b>PZ0</b>	0,45	3	1,0	1,0	2,2	2,2	2,2	2,0	2,0	2,0	2,0	2,0	2,0
<b>PZ1</b>	0,71	4,5	3,5	3,8	2,2 2,9	2,2 2,9	2,2 2,9	2,5 3,0	2,5 3,0	2,5 3,0	2,5 3,0	2,5 3,0	2,5 3,0
<b>PZ2</b>	1,00	6	8,2	10,3	3,5 4,8	3,5 4,8	3,5 4,8	3,5 5,0	3,5 5,0	3,5 5,0	4,0 5,0	4,0 5,0	4,0 5,0
<b>PZ3</b>	1,38	8	19,5	32,0	5,5 6,3	5,5 6,3	5,5 6,3	5,5 7,0	5,5 7,0	5,5 7,0	6,0	6,0	6,0
<b>PZ4</b>	2,10	10	38,0	88,7	8,0 9,5	8,0 9,5	8,0 9,5	8,0	8,0	8,0	8,0 10,0	8,0 10,0	8,0 10,0

\* LE NORME PREVEDONO CHE SOTTO IL VALORE DI COPPIA INDICATA IL PROFILO DELL'UTENSILE NON PRESENTI ALCUNA DEFORMAZIONE

\* THE STANDARDS REQUIRE THAT THE TOOL PROFILE DOES NOT DEFORM UNDER THE INDICATED TORQUE VALUES

# SCHEDE TECNICHE TECHNICAL DATASHEETS

**TORX®**

A REGISTERED TRADEMARK OF ACCUMENT GLOBAL TECHNOLOGIES



IN ACCORDO A NORME INTERNAZIONALI  
IN ACCORDANCE WITH INTERNATIONAL STANDARDS

COPPIA DI TORSIONE SECONDO NORME  
TIGHTENING TORQUE IN ACCORDANCE WITH THE STANDARDS

**TMD-702**

**TMD-702\***

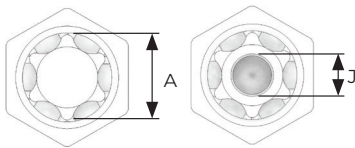

			Autofilettanti per metallo Self-tapping for metal			Autofilettanti per legno Self-tapping for wood			Metriche Metrics							

	A	J	 Nm	 Nm	 Nm	ISO 7049 = DIN 7981	ISO 7050 = DIN 7982	ISO 7051 = DIN 7983	DIN 7996	DIN 7997	DIN 7995	ISO 7045 = DIN 7985	ISO 7046 = DIN 965	ISO 7047 = DIN 966	DIN 912 7984 6912	ISO 4762 = DIN 912	ISO 10642 = DIN 7991
<b>TX03</b>	1,12			0,25								1,2	1,4	1,4	1,2		
<b>TX04</b>	1,30			0,37													
<b>TX05</b>	1,37		0,43	0,51								1,4 1,6	1,8		1,4 1,6		
<b>TX06</b>	1,65		0,75	0,91		2,2	2,2					1,3 2,0	2,0		1,3 2,0		
<b>TX07</b>	1,97		1,4	1,7													
<b>TX08</b>	2,30	0,74	2,2	2,6	2,2	2,9	2,9	2,9				2,5	2,5	2,5		2,5	
<b>TX09</b>	2,48	0,81	2,8	3,4	2,9	2,9											
<b>TX10</b>	2,27	0,94	3,7	4,5	3,8	3,5	3,5	3,5	3,0	3,0		3,0	3,0	3,0	3,0	3,0	3,0
<b>TX15</b>	3,26	1,19	6,4	7,7	6,5	3,9	3,9	3,9	3,5	3,5		3,5	3,5	3,5	3,5		
<b>TX20</b>	3,84	1,57	10,5	12,7	10,8	4,2	4,2	4,2	4,0 4,5	4,0 4,5	4,5	4,0	4,0	4,0	4,0	4,0	4,0
<b>TX25</b>	4,40	1,96	15,9	19,0	16,1	4,8 5,5	4,8 5,5	4,8 5,5	4,5 6,0	4,5 5,0	4,5	5,0	5,0	5,0	4,0 5,0	5,0	5,0
<b>TX27</b>	4,96	2,21	22,5	26,9	22,9										4,3 5,0		
<b>TX30</b>	5,49	2,72	31,1	37,4	31,8	6,3	6,3	6,3	6,0	6,0		6,0	6,0	6,0	6,0	6,0	6,0
<b>TX40</b>	6,60	3,15	54,1	65,1	55,3	8,0				8,0 10,0		8,0	8,0	8,0	8,0		8,0
<b>TX45</b>	7,77	3,40	86,0	104,0	88,0											8,0	
<b>TX50</b>	8,79	3,73	132,0	159,0	135,0	10,0						10,0	10,0	10,0	10,0	10,0	10,0
<b>TX55</b>	11,17	4,75		257,0	218,0	12,0									12,0	12,0	
<b>TX60</b>	13,20	5,56		445,0	379,0										14,0	14,0	
<b>TX70</b>	15,49	6,73		701,0	596,0												

\* PER QUESTO PROFILO I VALORI DI COPPIA INDICATI CORRISPONDONO AL VALORE MINIMO DI ROTTURA  
\* THE TORQUE VALUES INDICATED FOR THIS PROFILE CORRESPOND TO THE MINIMUM BREAKING VALUE

# SCHEDE TECNICHE TECHNICAL DATASHEETS

**TORX-PLUS®**

**TORX-PLUS® TAMPER RESISTANT**

A REGISTERED TRADEMARK OF ACCUMENT GLOBAL TECHNOLOGIES



IN ACCORDO A NORME INTERNAZIONALI  
IN ACCORDANCE WITH INTERNATIONAL STANDARDS

COPPIA DI TORSIONE SECONDO NORME  
TIGHTENING TORQUE IN ACCORDANCE WITH THE STANDARDS

**NMD-702**  
**NMD-602**

**NMD-702\***  
**NMD-602\***

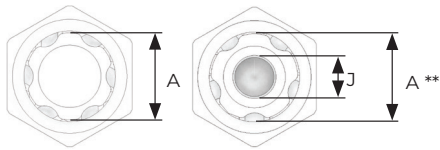

\*\* DIAMETRO CIRCOSCRITTO · \*\* CIRCUMSCRIBED DIAMETER ·

		Autofilettanti per metallo Self-tapping for metal			Metriche Metrics										
	A	Nm		A	J	Nm	ISO 7049 = DIN 7981	ISO 7050 = DIN 7982	ISO 7051 = DIN 7983	ISO 7045 = DIN 7985	ISO 7046 = DIN 965	ISO 7047 = DIN 966	DIN 912 = 7984 = 6912	ISO 4762 = DIN 912	ISO 10642 = DIN 7991
<b>10IP</b>	2,72	5,42	<b>10IPR</b>	2,72	0,91	4,3	3,5	3,5	2,9 3,5	3,0	3,0	3,0	3,0	3,0	5,0
<b>15IP</b>	3,25	9,62	<b>15IPR</b>	3,25	1,17	7,3	3,9	3,9	3,5 3,9	3,5	3,5 4,0	3,5			6,0
<b>20IP</b>	3,84	16,15	<b>20IPR</b>	3,84	1,55	11,9	4,2	4,2	4,2	4,0	4,0 5,0	4,0	4,0	4,0	6,0
<b>25IP</b>	4,39	23,50	<b>25IPR</b>	4,39	1,93	17,4	4,8 5,5	4,8 5,5	4,8 5,5	5,0	5,0 6,0	5,0	5,0	5,0	7,0 8,0
<b>27IP</b>	4,95	34,62	<b>27IPR</b>	4,95	2,18	25,1									8,0
<b>30IP</b>	5,49	47,18	<b>30IPR</b>	5,49	2,57	33,5	6,3	6,3	6,3	6,0	6,0	6,0	8,0	6,0	
<b>40IP</b>	6,60	82,08	<b>40IPR</b>	6,60	2,92	59,4			8,0		8,0	8,0	8,0	8,0	10,0

\* PER QUESTO PROFILO I VALORI DI COPPIA INDICATI CORRISPONDONO AL VALORE MINIMO DI ROTTURA

\* THE TORQUE VALUES INDICATED FOR THIS PROFILE CORRESPOND TO THE MINIMUM BREAKING VALUE

# SCHEDE TECNICHE TECHNICAL DATASHEETS

## ESAGONO



IN ACCORDO A NORME INTERNAZIONALI  
IN ACCORDANCE WITH INTERNATIONAL STANDARDS

COPPIA DI TORSIONE SECONDO NORME  
TIGHTENING TORQUE IN ACCORDANCE WITH THE STANDARDS

**DIN 911**  
**DIN 7426**

**DIN 7426\***  
**ISO 2936\***

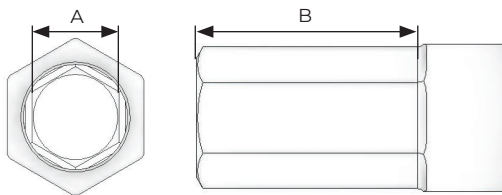

Ø	A	B <sub>MIN</sub>	Nm	Nm	Metriche Metrics				
					DIN 7984	ISO 4762 = DIN 7984	ISO 10642 = DIN 7991	DIN 908	DIN 913 914 DIN 915 916
<b>0,7</b>	0,7	1,6	0,08						1,4 1,8
<b>0,9</b>	0,9	1,8	0,18						2,0
<b>1,3</b>	1,3	2,0	0,53			1,4			2,5
<b>1,5</b>	1,5	2,3	0,82	0,95		1,6 2,0			3,0
<b>2,0</b>	2,0	3,0	1,9	2,3	3,0	2,5	3,0		4,0
<b>2,5</b>	2,5	3,8	3,4	4,4	4,0	3,0	4,0		5,0
<b>3,0</b>	3,0	4,5	6,6	7,6	5,0	4,0	5,0		6,0
<b>4,0</b>	4,0	6,0	16,0	18,0	6,0	5,0	6,0		8,0
<b>5,0</b>	5,0	7,5	30,0	35,0	8,0	6,0	8,0	10,0	10,0
<b>6,0</b>	6,0	9,0	52,0	61,0		8,0	10,0	12,0 14,0	12,0 14,0
<b>7,0</b>	7,0	10,5	78,0	97,0	10,0				
<b>8,0</b>	8,0	12,0	120,0	140,0	12,0	10,0	12,0	16,0 18,0	16,0 18,0
<b>10,0</b>	10,0	16,0	220,0	280,0	14,0	12,0	14,0 16,0	20,0 22,0	20,0 22,0
<b>12,0</b>	12,0	18,0	370,0	480,0	16,0 18,0	14,0	18,0 20,0	24,0 26,0	24,0 26,0
<b>14,0</b>	14,0	25,0	590,0		20,0 22,0	16,0 18,0	22,0 24,0		

\* LE NORME PREVEDONO CHE SOTTO IL VALORE DI COPPIA INDICATA IL PROFILO DELL'UTENSILE NON PRESENTI ALCUNA DEFORMAZIONE

\* THE STANDARDS REQUIRE THAT THE TOOL PROFILE DOES NOT DEFORM UNDER THE INDICATED TORQUE VALUES

# SCHEDE TECNICHE TECHNICAL DATASHEETS

## TAGLIO



IN ACCORDO A NORME INTERNAZIONALI  
IN ACCORDANCE WITH INTERNATIONAL STANDARDS

COPPIA DI TORSIONE SECONDO NORME  
TIGHTENING TORQUE IN ACCORDANCE WITH THE STANDARDS

### DIN-ISO 2380

### DIN-ISO 2380\*

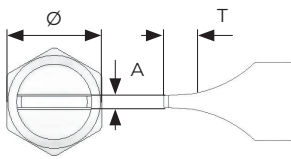

Ø	A	T	Nm	Nm	Autofilettanti per metallo Self-tapping for metal			Autofilettanti per legno Self-tapping for wood			Metriche Metrics						
					ISO 1481 = DIN 7971	ISO 1482 = DIN 7972	ISO 1483 = DIN 7973	DIN 96	DIN 97	DIN 95	ISO 1207 = DIN 84	ISO 1580 = DIN 85	ISO 2009 = DIN 963	ISO 2010 = DIN 964	ISO 4766 7435 = DIN 417-427		
1,5	0,30	0,50		0,15													
1,8	0,37	0,50		0,28							1,2 1,4						
2,0	0,40	0,70	0,3	0,35				1,6	1,6				1,6			2,5 3,0	
2,5	0,40	0,70	0,4	0,45				2,0		1,6	1,6 1,8			1,6		3,5	
3,0	0,50	0,90	0,7	0,8		2,2	2,2		2,0	2,0	2,0		2,0	2,0	2,0	4,0	
3,5	0,60	1,10	1,3	1,4	2,2			2,5	2,5	2,5	2,5		2,5	2,5			
4,0	0,50	0,90		1,1				2,0									
4,0	0,80	1,40	2,6	2,9	2,9	2,9	2,9	3,0 3,5	3,0 3,5	3,0 3,5	3,0	3,0	3,0 3,5	3,0 3,5	5,0 6,0		
4,5	0,60	1,10		1,8	2,2			2,5			2,5						
5,0	0,80	1,40	3,2	3,6													
5,5	0,80	1,40	3,5	3,9				3,5		3,5	3,0	3,5	3,5	3,5			
5,5	1,00	1,80	5,5	6,2	3,5 3,9	3,5 3,9	3,5 3,9	4,0 4,5	4,0 4,5	4,0 4,5	3,5	3,5	4,0	4,0			
6,0	1,00	1,80		6,7													
6,5	1,20	2,20	9,4	10,5		4,2 4,8	4,2	5,0 5,5	5,0	5,0	4,0		5,0	5,0	8,0		
7,0	1,20	2,20	10,0	11,3													
8,0	1,20	2,20	11,5	12,9	4,2		4,8		5,5	5,5	5,0	4,0					
8,0	1,60	2,90	20,5	22,9	4,8	5,5 6,3	5,5	6,0	6,0	6,0		5,0	6,0	6,0	10,0 12,0		
10,0	1,60	2,90	25,6	28,7	5,5 6,3		6,3		7,0 8,0	7,0	6,0				14,0		
13,0	2,00	3,60	52,0	58,0				8,0	10,0		8,0	8,0	8,0	8,0	16,0		

\* LE NORME PREVEDONO CHE SOTTO IL VALORE DI COPPIA INDICATA IL PROFILO DELL'UTENSILE NON PRESENTI ALCUNA DEFORMAZIONE

\* THE STANDARDS REQUIRE THAT THE TOOL PROFILE DOES NOT DEFORM UNDER THE INDICATED TORQUE VALUES

# SCHEDE TECNICHE TECHNICAL DATASHEETS

**TORX®**

A REGISTERED TRADEMARK OF ACCUMENT GLOBAL TECHNOLOGIES



IN ACCORDO A SPECIFICA ACCUMENT GLOBAL TECHNOLOGIES  
IN ACCORDANCE WITH THE SPECIFICATIONS OF ACCUMENT GLOBAL TECHNOLOGIES

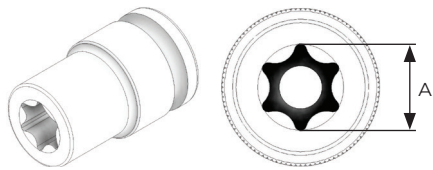

Metriche  
Metrics



	A	Metriche Metrics	
		ISO 4014 - 4017 = DIN 931 - 933	ISO 8100 = DIN 6921
	A		
<b>E5</b>	4,72	4,0	
<b>E6</b>	5,69	5,0	4,0
<b>E7</b>	6,17		
<b>E8</b>	7,47	6,0 7,0	5,0
<b>E10</b>	9,37	8,0	6,0
<b>E11</b>	10,03		
<b>E12</b>	11,12	10,0 11,0	8,0
<b>E14</b>	12,85	12,0	10,0
<b>E16</b>	14,71		
<b>E18</b>	16,64	14,0	12,0
<b>E20</b>	18,41	16,0	14,0
<b>E22</b>	20,24		
<b>E24</b>	22,09	18,0 20,0	

# SCHEDE TECNICHE TECHNICAL DATASHEETS

## ESAGONO



IN ACCORDO A NORME INTERNAZIONALI  
IN ACCORDANCE WITH INTERNATIONAL STANDARDS

COPPIA DI TORSIONE SECONDO NORME  
TIGHTENING TORQUE IN ACCORDANCE WITH THE STANDARDS

### DIN 3129

### DIN-ISO 1711\*



			Autofilettanti per metallo <i>Self-tapping for metal</i>	Autofilettanti per legno <i>Self-tapping for wood</i>	Metriche <i>Metrics</i>		
	 Nm	 Nm	ISO 1479 = DIN 7976	DIN 571	ISO 4014 4016 4017	ISO 4035 4036 = DIN 439	ISO 4032 4033 = DIN 934
<b>4</b>		10,4			2,0	2,0	2,0
<b>4,5</b>		12,6			2,3		
<b>5</b>	11,5	15,1	2,9		2,5	2,5	2,5
<b>5,5</b>	14,4	17,8	3,5		3,0	3,0	3,0
<b>6</b>	17,6	23,2			3,5	3,5	3,5
<b>7</b>	25,2	33,2	3,9 4,2	4,0	4,0	4,0	4,0
<b>8*</b>	34,5	94,1	4,8 5,5	5,0	5,0	5,0	5,0
<b>9*</b>	45,4	119,2					
<b>10*</b>	58,1	147,0	6,3	6,0	6,0	6,0	6,0
<b>11*</b>	72,7	178,0			7,0		7,0
<b>12*</b>	89,1	212,0		7,0			
<b>13*</b>	107,0	249,0	8,0	8,0	8,0	8,0	8,0
<b>14*</b>	128,0	288,0					

\* VALUTARE ANCHE RESISTENZA ATTACCO











































\* ALSO EVALUATE ATTACHMENT RESISTANCE

# SCHEDE TECNICHE

## TECHNICAL DATASHEETS

### ATTACCHI MASCHIO STANDARD, APPLICAZIONI, RESISTENZE









#### STANDARD MALE ATTACHMENTS, APPLICATIONS, RESISTANCES



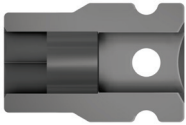



	 A  B		APPLICAZIONE APPLICATION	STANDARDS	Nm
	A=3mm			DIN 3126 Form A3	7,6
	A=4mm - 5/32"			DIN 3126 Form C4	18,0
	A=5,5mm			DIN 3126 Form A5,5	47,0
	B=VARIE			LTI	N.A.
	B=7mm			LTI	N.A.
	A=6,35mm - 1/4"			DIN 3126 Form C6,3	71,0
	A=6,35mm - 1/4"			DIN 3126 Form E6,3	71,0
	A=7,93mm - 5/16"			DIN 3126 Form C8	144,0
	A=7,93mm - 5/16"			FIAM-DESOUTTER	144,0
	A=9,52mm - 3/8"			AUTOMOTIVE	280,0
	A=11,2mm - 7/16"			DIN 3126 Form E11,2	396,0
	B=M4x0,7			ISO 724 - DIN 13.1	7,0
	B=M5x0,8			ISO 724 - DIN 13.1	18,0
	B=M6x1			ISO 724 - DIN 13.1	25,0
	B=10x32 UNF			ISO 724 - DIN 13.1	18,0
	B=BSF 3/16x32 Whitworth			ISO 724 - DIN 13.1	18,0

# SCHEDE TECNICHE TECHNICAL DATASHEETS

## ATTACCHI QUADRO STANDARD, APPLICAZIONI, RESISTENZE

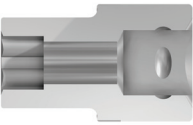
### STANDARD SQUARE ATTACHMENTS, APPLICATIONS, RESISTANCES

			APPLICAZIONE APPLICATION	STANDARDS	Nm
	A=6,35mm - 1/4"			DIN 3121 Form G6,3	68,6
	A=9,52mm - 3/8"			DIN 3121 Form G10	225,0
	A=12,70mm - 1/2"			DIN 3121 Form G12,5	569,0
	A=19,05mm - 3/4"			DIN 3121 Form H20	1569,0
	A=25,40mm - 1"			DIN 3121 Form H25	2795,0
	A=38,10mm - 1-1/2"			DIN 3121 Form H40	

			APPLICAZIONE APPLICATION	STANDARDS	Nm
	A=6,35mm - 1/4"			DIN 3121 Form G6,3	62,0
	A=9,52mm - 3/8"			DIN 3121 Form G10	202,0
	A=12,70mm - 1/2"			DIN 3121 Form G12,5	512,0
	A=19,05mm - 3/4"			DIN 3121 Form D20	1412,0