

IEC Appliance Inlet C8 with Filter, Front Side Mounting

Standard- or Medical-Filter



Snap-in mounting from front side

Screw-on mounting from front side

C8  
  
70° C



**Description**

- Panel Mount:  
Screw-on or snap-in mounting from front side
- 2 Functions:  
Appliance Inlet Protection class II, Line filter in standard and medical version
- Solder terminals or quick connect terminals

**Approvals**

- VDE Certificate Number: 40029278
- UL File Number: E72928

**Characteristics**

- Compact high performance filter
- Designed for standard and medical applications
- Suitable for use in equipment according to IEC/UL 60950
- Suitable for use in medical equipment according to IEC/UL 60601-1

**Other versions on request**

- Standard version without X-capacitor

**References**

Alternative: version without line filter [0721-PS](#); [2578](#)

**Weblinks**

[pdf-datasheet](#), [html-datasheet](#), [General Product Information](#), [RoHS](#), [CHINA-RoHS](#), [REACH](#), [Mating Connectors](#), [e-Shop](#), [SCHURTER-Stock-Check](#), [Distributor-Stock-Check](#), [Accessories](#)

**Technical Data**

Ratings IEC	0.5 - 2.5A @ Ta 40 °C / 250VAC; 50Hz	Appliance-Inlet/-Outlet	C8 acc. to IEC 60320
Ratings UL/CSA	0.5 - 6A @ Ta 40 °C / 250VAC; 60Hz	Line Filter	UL 498, CSA C22.2 no. 42 (for cold conditions) pin-temperature 70 °C, 2.5A, Protection Class II
Dielectric Strength	> 1.7kVDC between L-N > 4kVDC between L/N-PE Test voltage (2 sec)	MTBF	Standard and Medical Version, IEC 60939, UL 1283, CSA C22.2 no. 8 <a href="#">Technical Details</a>
Impulse Withstand Voltage	> 2.5kV between L-N		
Allowable Operation Temp.	-25 °C to 85 °C		
Climatic Category	25/085/21 acc. to IEC 60068-1		
Degree of Protection	from front side IP 40 acc. to IEC 60529		
Protection Class	Suitable for appliances with protection class II acc. to IEC 61140		
Terminal	solder pin or quick connect terminals 6.3 x 0.8 or 4.8 x 0.8 mm		
Panel Thickness s	Screw Mounting screw torque max 0.5Nm Snap-in 1 mm to 3mm		
Material: Housing	Thermoplastic, black, UL 94V-0		

**Dimension**

Screw-on mounting from front side

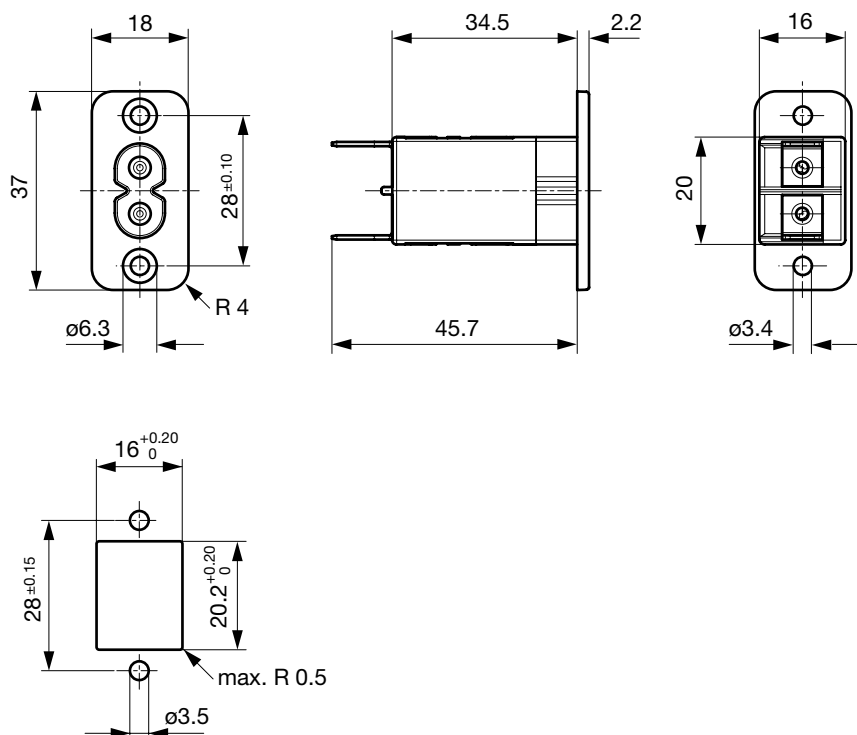

Snap-in mounting from front side

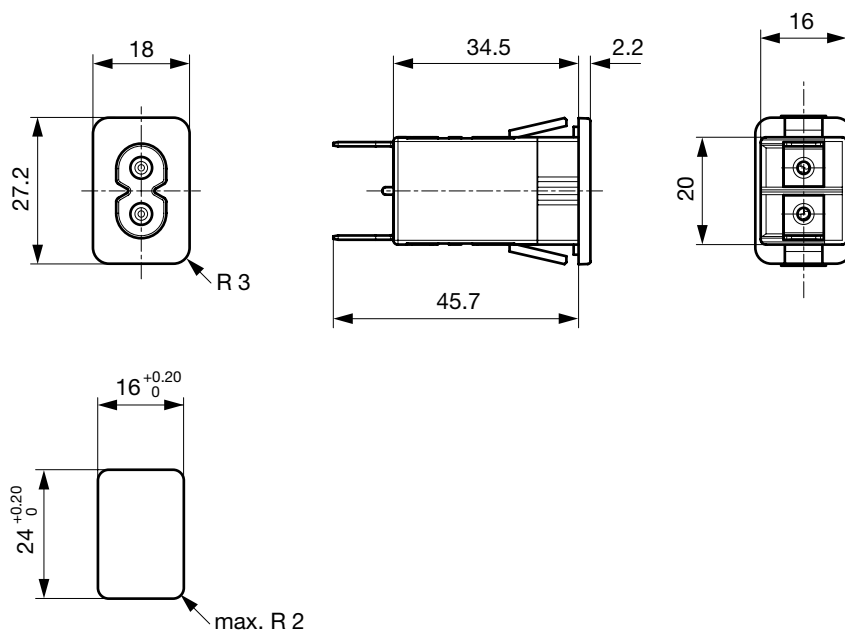

### Technical Data of Filter-Components

Rated Current [A]	Filter-Type	Inductances L [mH]	Capacitance CX [nF]	Capacitance CY [nF]	R [MΩ]
1	Standard Version without Cx	2 x 8	-	-	-
0.5	Standard Version	2 x 18	100	-	-
1	Standard Version	2 x 8	100	-	-
2.5	Standard Version	2 x 1.2	100	-	-
4	Standard Version	2 x 0.8	100	-	-
6	Standard Version	2 x 0.3	100	-	-
0.5	Medical Version (M5)	2 x 18	100	-	1
1	Medical Version (M5)	2 x 8	100	-	1
2.5	Medical Version (M5)	2 x 1.2	100	-	1
4	Medical Version (M5)	2 x 0.8	100	-	1
6	Medical Version (M5)	2 x 0.3	100	-	1

### Diagrams

Standard version

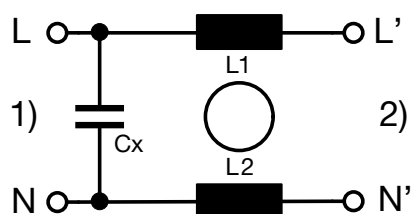

1) Line  
2) Load

Medical version M5

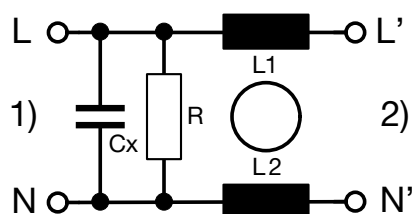

1) Line  
2) Load

### Derating Curves

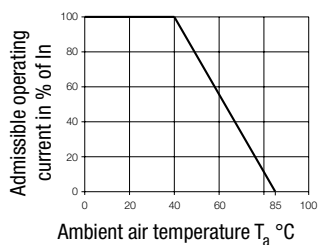

**Attenuation Loss**

Standard version

--- differential mode    \_\_\_\_ common mode

0.5 A

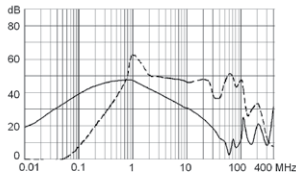

1 A

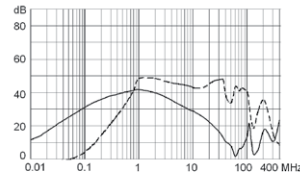

2.5 A

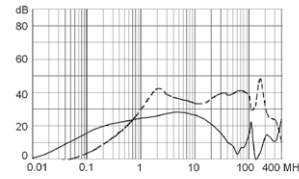

4 A

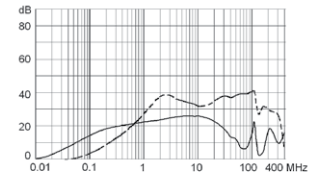

6 A

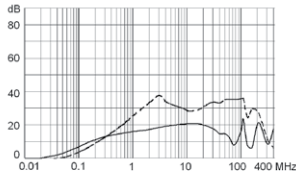

Medical version (M5)

0.5 A

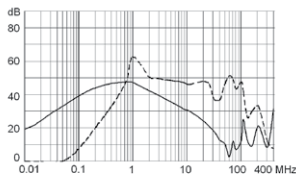

1 A

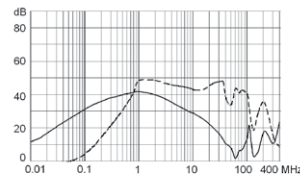

2.5 A

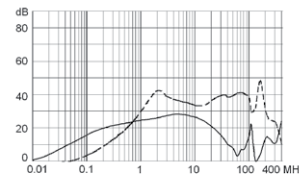

4 A

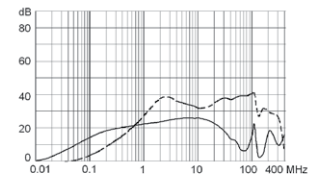

6 A

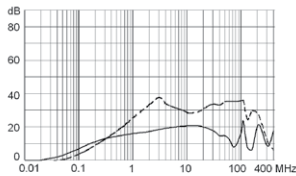

**All Variants**

Rated Current [A]	Filter-Type	Mounting	Terminal	Order Number
1	Standard Version without Cx	Snap-in 1.5	Quick connect terminal 4.8 x 0.8 mm	5008.2211
0.5	Standard Version	Snap-in 1.0	Quick connect terminal 4.8 x 0.8 mm	5008.1010
0.5	Standard Version	Snap-in 1.5	Quick connect terminal 4.8 x 0.8 mm	5008.2010
1	Standard Version	Snap-in 1.5	Solder terminal	5008.2021
1	Standard Version	Snap-in 1.5	Quick connect terminal 6.3 x 0.8 mm	5008.2001
1	Standard Version	Snap-in 2.0	Quick connect terminal 4.8 x 0.8 mm	5008.3011
2.5	Standard Version	Screw	Solder terminal	5008.0022
2.5	Standard Version	Screw	Quick connect terminal 6.3 x 0.8 mm	5008.0002
2.5	Standard Version	Screw	Quick connect terminal 4.8 x 0.8 mm	5008.0012
2.5	Standard Version	Snap-in 1.0	Quick connect terminal 4.8 x 0.8 mm	5008.1012
2.5	Standard Version	Snap-in 1.5	Solder terminal	5008.2022
2.5	Standard Version	Snap-in 1.5	Quick connect terminal 4.8 x 0.8 mm	5008.2012
2.5	Standard Version	Snap-in 2.0	Solder terminal	5008.3022
2.5	Standard Version	Snap-in 2.0	Quick connect terminal 6.3 x 0.8 mm	5008.3002
4	Standard Version	Snap-in 1.5	Quick connect terminal 4.8 x 0.8 mm	5008.2014
6	Standard Version	Screw	Quick connect terminal 6.3 x 0.8 mm	5008.0006

Rated Current [A]	Filter-Type	Mounting	Terminal	Order Number
6	Standard Version	Snap-in 1.0	Quick connect terminal 4.8 x 0.8 mm	<a href="#">5008.1016</a>
6	Standard Version	Snap-in 1.5	Quick connect terminal 4.8 x 0.8 mm	<a href="#">5008.2016</a>
0.5	Medical Version (M5)	Snap-in 1.0	Quick connect terminal 4.8 x 0.8 mm	<a href="#">5008.1110</a>
1	Medical Version (M5)	Screw	Quick connect terminal 4.8 x 0.8 mm	<a href="#">5008.0111</a>
1	Medical Version (M5)	Snap-in 1.0	Quick connect terminal 4.8 x 0.8 mm	<a href="#">5008.1111</a>
1	Medical Version (M5)	Snap-in 2.0	Quick connect terminal 4.8 x 0.8 mm	<a href="#">5008.3111</a>
2.5	Medical Version (M5)	Snap-in 1.0	Quick connect terminal 4.8 x 0.8 mm	<a href="#">5008.1112</a>
2.5	Medical Version (M5)	Snap-in 2.0	Quick connect terminal 6.3 x 0.8 mm	<a href="#">5008.3102</a>
4	Medical Version (M5)	Snap-in 1.0	Quick connect terminal 4.8 x 0.8 mm	<a href="#">5008.1114</a>
4	Medical Version (M5)	Snap-in 1.5	Quick connect terminal 4.8 x 0.8 mm	<a href="#">5008.2114</a>
6	Medical Version (M5)	Snap-in 1.0	Quick connect terminal 4.8 x 0.8 mm	<a href="#">5008.1116</a>
6	Medical Version (M5)	Snap-in 1.5	Quick connect terminal 4.8 x 0.8 mm	<a href="#">5008.2116</a>

Availability for all products can be searched real-time: <http://www.schurter.com/en/Stock-Check/Stock-Check-SCHURTER>

**Packaging unit** 20 Pcs

### Mating Outlets/Connectors

#### Category / Description



[Appliance Outlet Overview complete](#)

IEC Appliance Outlet D, Screw-on Mounting, Front Side, Solder Terminal

[5082](#)

[Appliance Outlet further types to 5008](#)



[Connector Overview complete](#)

IEC Appliance Outlet D, Screw-on Mounting, Front Side, Solder Terminal

[5084](#)

IEC Appliance Outlet D, insert Mounting, Solder Terminal

[5086](#)

[Connector further types to 5008](#)