



Components and Methods for Current Measurement

By Bryan Yarborough

PURPOSE

Current sensing is used to perform two essential circuit functions. First, it is used to measure “how much” current is flowing in a circuit, which may be used for power management in a DC/DC power supply to determine essential peripheral loads to conserve power. The second function is to determine when it is “too much,” or a fault condition. If current exceeds safe limits, then a software or hardware interlock condition is met and provides a signal to turn off the application, as in a motor stall or short circuit condition in a battery. It is essential to choose the appropriate technology with a robust design to properly withstand the extreme conditions that can exist during a fault. The appropriate component performing the measurement function would need to sustain an accurate voltage signal as well as prevent damage to the printed circuit board.

MEASUREMENT METHODS

A signal to indicate the “how much” condition and the “too much” condition is available in a variety of different measurement methods, as listed below:

1. Resistive (direct)
 - a. Current sense resistors
2. Magnetic (indirect)
 - a. Current transformer
 - b. Rogowski coil
 - c. Hall effect device
3. Transistor (direct)
 - a. $R_{DS(ON)}$
 - b. Ratio-metric

Each has advantages that make it an effective or acceptable method for current measurement, but also has tradeoffs that can be critical to the end reliability of the application. They can also be classified into two main categories of measurement methods: direct or indirect. The direct method means that it is connected directly in the circuit being measured and that the measurement components are exposed to the line voltage, whereas the indirect method provides isolation that may be necessary for design safety.

1. Resistive

Current Sense Resistor

The resistor is a direct method of current measurement that has the benefit of simplicity and linearity. The current sense resistor is placed in line with the current being measured and the resultant current flow causes a small amount of power to be converted into heat. This power conversion is what provides the voltage signal. Other than the favorable characteristics of simplicity and linearity, the current sense resistor is a cost-effective solution with a stable temperature coefficient of resistance (TCR) of $< 100 \text{ ppm}/^{\circ}\text{C}$ or $0.01 \text{ } \%/^{\circ}\text{C}$ and does not suffer the potential of avalanche multiplication or thermal runaway. Additionally, low-resistance ($< 1 \text{ m}\Omega$ is available) metal alloy current sense products offer superior surge performance for reliable protection during short circuit and overcurrent events.

Components and Methods for Current Measurement

2. Magnetic

Current Transformer

A current transformer (Fig. 1) provides three key advantages: isolation from line voltage; lossless current measurement; and a large signal voltage that can provide noise immunity. This indirect current measurement method requires a changing current - such as an AC, transient current, or switched DC - to provide a changing magnetic field that is magnetically coupled into the secondary windings. The secondary measurement voltage can be scaled according to the turns ratio between the primary and secondary windings. This measurement method is considered “lossless” because the circuit current passes through the copper windings with very little resistive losses (Fig. 2). However, a small amount of power is lost due to transformer losses from the burden resistor, core losses, and primary and secondary DC resistance.

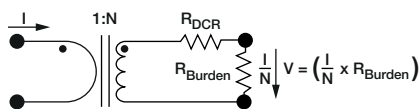

Fig. 1 - Ideal current transformer circuit

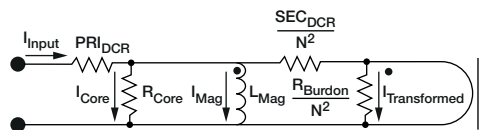

Fig. 2 - Current transformer loss components

Rogowski Coil

The Rogowski coil (Fig. 3) is similar to a current transformer in that a voltage is induced into a secondary coil that is proportional to the current flow through an isolated conductor. The difference is that the Rogowski coil is an air core design as opposed to the current transformer that relies upon a high-permeability core, such as a laminated steel, to magnetically couple to a secondary winding. The air core design has a lower inductance to provide a faster signal response and very linear signal voltage. Because of its design, it is often used as a temporary current measurement method on existing wiring such as a handheld meter. This could be considered a lower-cost alternative to the current transformer.

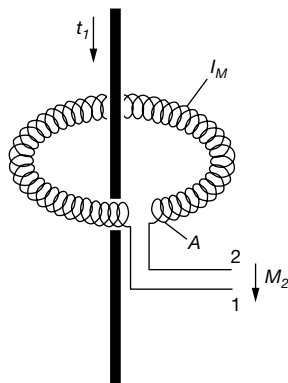
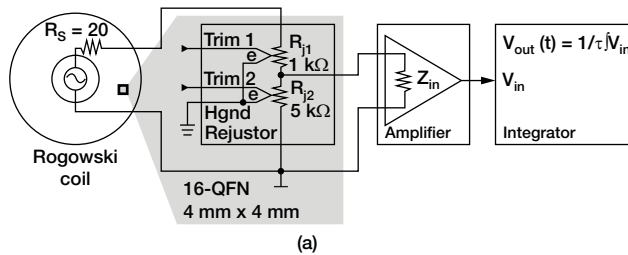
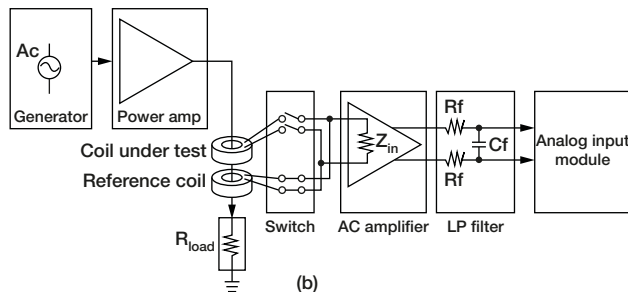

Fig. 3



(a)



(b)

Components and Methods for Current Measurement

Hall Effect

When a current-carrying conductor is placed in a magnetic field (Fig. 4), a difference in potential occurs perpendicular to the magnetic field and the direction of current flow. This potential is proportional to the magnitude of the current flow. When there is no magnetic field and current flow exists, then there is no difference in potential. However, when a magnetic field and current flow exist, the charges interact with the magnetic field causing the current distribution to change, which creates the hall voltage (Fig. 5).

The advantage of hall effect devices is that they are capable of measuring large currents with low power dissipation. However, there are numerous drawbacks that can limit their use, such as non-linear temperature drift requiring compensation, limited bandwidth, low-range current detection requiring a large offset voltage that can lead to error, susceptibility to external magnetic fields, ESD sensitivity, and high cost.

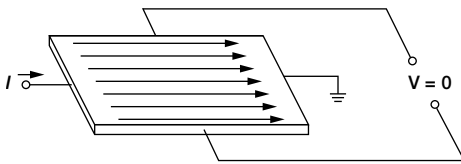

Fig. 4 - Hall effect principle, no magnetic field

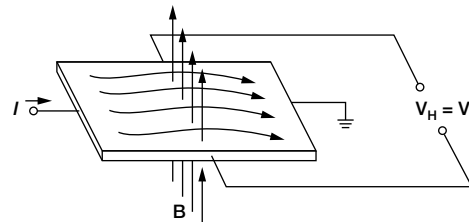

Fig. 5 - Hall effect principle, magnetic field present

3. Transistor

R_{DS(ON)} - Drain-to-Source On-Resistance

Transistors are considered a “lossless” overcurrent detection method since they are standard control components to the circuit design and no further resistance or power dissipating devices are required to provide a control signal. Transistor datasheets provide the on-resistance for the drain-to-source ($R_{DS(ON)}$) with a typical resistance in the $m\Omega$ range for power MOSFETs. This resistance consists of several components that begin with the leads (Fig. 6) connecting to the semiconductor die through the resistance that makes up the numerous channel characteristics. Based on this information, the current passing through the MOSFET can be determined by $I_{Load} = V_{RDS(ON)} / R_{DS(ON)}$.

Each constituent of the $R_{DS(ON)}$ contributes to measurement errors that are due to minor variations in the resistances of the interface regions and TCR effects. The TCR effects can be partially compensated by measuring temperature and correcting the measured voltage with anticipated changes in resistance due to temperature. Often times the TCR for MOSFETs can be as large as 4000 ppm/°C, which is equivalent to a 40 % change in resistance for a 100 °C rise. Generally, this measurement method provides a signal with approximately 10 % to 20 % accuracy. Depending on the accuracy requirements, this may be an acceptable range for providing overcurrent protection.

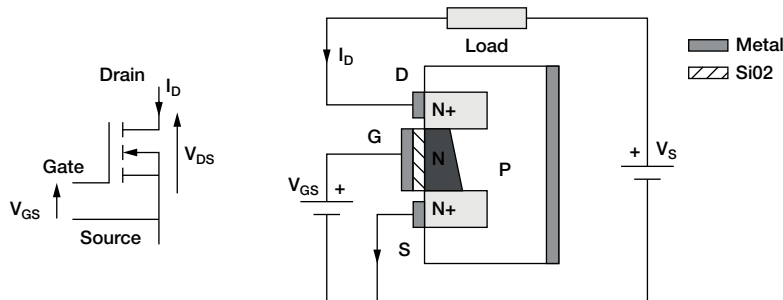

Fig. 6 - Simple model of an n-channel enhancement type MOSFET

Components and Methods for Current Measurement

Ratio Metric - Current Sense MOSFETs

The MOSFET consists of thousands of parallel transistor cells that reduce the on-resistance. The current sensing MOSFET uses a small portion of the parallel cells and connects to the common gate and drain, but a separate source (Fig. 7). This creates a second isolated transistor; a “sense” transistor. When the transistor is turned on, the current through the sense transistor will be a ratio comparable to the main current through the other cells.

Depending on the transistor product, the accuracy tolerance range can vary from as low as 5 % to as wide as 15 % or 20 %. This is generally not suitable for current control applications that typically require 1 % measurement accuracy, but is intended for overcurrent and short circuit protection.

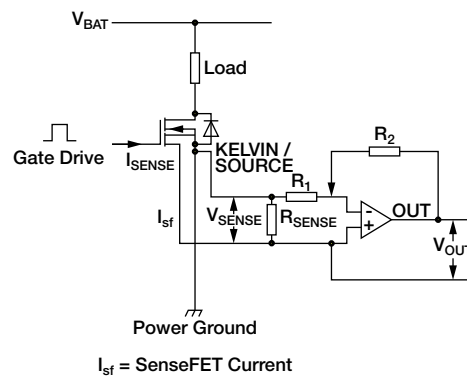

Fig. 7

MEASUREMENT METHOD	ACCURACY	ISOLATION	EMI (TAMPER RESISTANCE)	ROBUST	SIZE	COST
RESISTIVE (DIRECT)						
Sense resistor	High	No	High	High	Small	Low
TRANSISTOR (DIRECT)						
$R_{DS(ON)}$	Low	No	Moderate	Moderate	Small	Low
Ratio metric	Moderate	No	Moderate	Moderate	Small	Moderate
MAGNETIC (INDIRECT)						
Current Transformer	High	Yes	Moderate	High	Large	Moderate
Rogowski coil	High	Yes	Moderate	High	Large	Moderate
Hall effect	High	Yes	High	Moderate	Moderate	High

4. Resistor Technology Options

Resistor Technologies

I will begin the explanation of the impact of resistive technology with the least robust technology for current sense applications and progress through to the most robust technology.

Thin Film: These devices are not typically used for current sense applications, but are included in this discussion to provide breadth to the topic. Generally these resistive products are for precision applications because of their resistive layer ranges from 0.0000012" to 0.000004" thick. They are quite surge-tolerant in the appropriate application, but are not designed for the high currents typically associated with the applications mentioned in this article.

Components and Methods for Current Measurement

Vishay Thick Film Resistor Products: The RCWE and RCWL are typically 0.0005" to 0.002" thick, which is nearly 100 times that of thin film. The increased thickness equates to a greater mass that is better able to carry the relatively high currents and dissipate the heat across the substrate, as well as better able to manage transients. Another advantage of thick film products is their flexibility; standard resistance values are available across a wide resistance range because of laser trimming and film composition. A tradeoff for thick film vs. thin film is that thick film is not capable of the very tight tolerances of thin film products.

Vishay resistor products: RCWE, RCWL

Vishay Power Metal Strip® Resistor Products: The WSLP, WSL3921, WSL5931, WSR, WSHM, WSBS, and WSMS... (bulk alloy) have the greatest surge capability because of their large current-carrying mass. They are available in resistance values as low as 0.000005 Ω with low TCR and are the best choice for high-current power supplies or where fault conditions can result in extreme currents. These products do not have as wide of a resistance offering as thick film resistors because the resistor alloy has limited resistivity and minimum alloy thickness to reach high range values.

Vishay Power Metal Strip resistor products: WSL, WSLT, WSLP, WSR, WSHM2818, WSBS, WSMS...

Power Metal Strip product overview (see "related information" table)

5. Product-Specific Features

Four-Terminal or Kelvin Construction

High-current applications require very low resistance values to minimize power loss, while providing an appropriate voltage signal high enough to exceed the noise floor. The low ohmic values, typically < 25 mΩ, often times benefit from a four-terminal device that reduces measurement errors by separating the current flow from the voltage sense locations. This reduces two types of errors: contact resistance as the part is mounted to the board, and the high temperature coefficient effects from the amount of in-circuit copper (3900 ppm/°C). The WSK, WSK0612, WSL2726, WSLP2726, WSLT2726, WSL4026, WSLP4026, WSLT4026, and WSL3637 all feature four-terminal constructions.

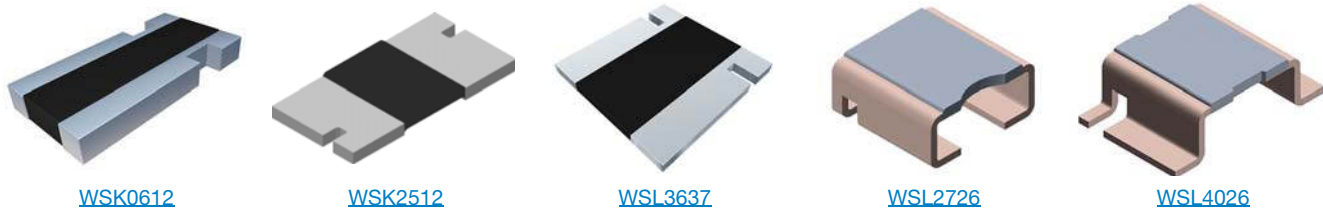

The following illustration from the Power Metal Strip product overview (see "related information" table) shows the pin designations for a proper Kelvin connection.

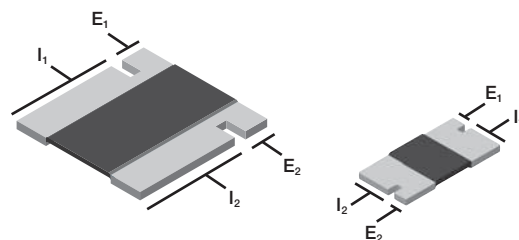

(E₁ & E₂ Voltage Connections, I₁ & I₂ Current Connections)

High Temperature

Hall effect and transistor current sense measurement can be adversely affected by high temperatures that can introduce non-linear measurement errors, as well as compromise the long-term measurement stability. Increased temperature can affect active devices by increasing the availability of charge carriers, whereas a resistor solution is entirely based on the fixed metallurgical properties. Vishay Dale resistors use proprietary manufacturing processes that deliver products that are capable of long-term stable operation at temperatures up to 275 °C. The high-temperature capability also enables a design to function at higher rated power for the same temperature than other resistor manufacturers or comparable products; for a similar design rated temperature.

Components and Methods for Current Measurement

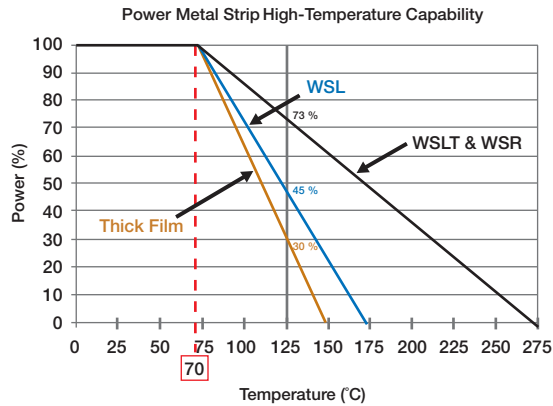

Thermal Performance

There are four key advantages of the resistor construction in thermal design:

1. Degradation of the PCB Material - Standard FR4 PCB material is only rated to 130 °C; a typical power resistor that is against the board could cause damage to the material during power excursions or reduce the upper temperature performance of the circuit. An elevated current sense prevents damage to the circuit material and can permit the solder joint to run cooler, such as with the WSL2726 or WSL4026.

The WSL provides a low profile, but still provides the board clearance that protects the PCB from hot spot exposure as indicated by the following images.

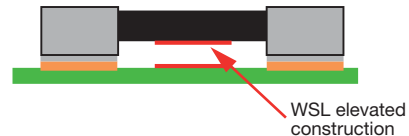

The elevated design of the WSL2726 and WSL4026 is unique among typical current sense resistors because it protects the circuit board from direct exposure to hot spot high temperatures and places the hot spot into the available airstream, which dissipates the maximum amount of heat energy to the air instead of the PCB.

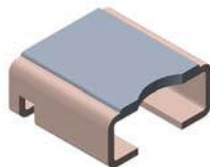

2. Deterioration in Performance of Nearby Power or Semiconductor Components - A portion of heat will be dissipated to the air instead of the PCB, which can positively affect the performance of nearby heat-affected devices. These effects may include lifetime rating, power handling, LED luminous output lifetime, accuracy ... or more simply put, reliability. Additionally, the low thermal EMF ($< 3 \mu\text{V}/^\circ\text{C}$) characteristics of the Power Metal Strip product (see “related information” table) assures that nearby power- / heat-generating components will minimize potential error that can be introduced from thermal gradients across the resistor. Standard thick film resistors have a typical thermal EMF of $40 \mu\text{V}/^\circ\text{C}$ to $50 \mu\text{V}/^\circ\text{C}$, and when multiplied by a 100°C temperature increase can introduce as much as 5 mV of error, which could exceed allowable measurement circuit error limits.

Components and Methods for Current Measurement

3. Coefficient of Thermal Expansion (CTE) Mismatch - The all-metal welded construction of the Power Metal Strip series minimizes solder joint stress that is a result of a CTE mismatch between the resistor and the circuit board. The cyclic stresses that result from the CTE mismatch due to a lifetime of thermal cycling can lead to fatigue stress cracks in the solder joint that can compromise long-term reliability. The mismatch is a result of the FR4 circuit board material having a CTE of approximately 18 ppm/°C, while ceramic has a CTE of 5 ppm/°C, which is more rigid and less able to expand with the circuit board material.

The Power Metal Strip series all-metal welded construction with a CTE of approximately 13 ppm/°C is more compatible with the 18 ppm/°C CTE of the FR4 material, therefore stress due a CTE mismatch is significantly reduced. This leads to long-term reliability, which is the reason why the Power Metal Strip series has been designed into applications used in automotive, military, and industrial markets since 1993.

4. Solder Joint Stress - The elevated construction of the WSL2726 and WSL4026 provides a greater ability to flex, which reduces the stress generated by differences in thermal expansion coefficients between the heat-producing metal and the dissipating circuit board material. Surface-mount ceramic resistors that are flat to the circuit board have a different coefficient of expansion from the PCB material, which applies shear forces to the solder joint that can lead to failure or changes in performance. In high thermal cycling applications, compliant terminations are preferred to other similar all-metal construction parts because of this flexibility feature.



The figures above illustrate how the forces on each part are dissipated as a result of differences in the thermal expansion coefficient between the current sense resistor and the circuit board materials.

RELATED INFORMATION	
Product Overview: Power Metal Strip® Surface-Mount Current Sensing Resistors	www.vishay.com/doc?49581
Video: Power Metal Strip® Resistor Thermal EMF (Product Demo)	www.vishay.com/videos/resistors/power-metal-strip174-resistor-power-coefficient-product-demo
Pulse Handling Capabilities of Vishay Dale Wirewound Resistors	www.vishay.com/doc?49076
Shunts, Current Shunts, and Current-Sensing Resistors	www.vishay.com/doc?49159