

CATALOG

Time relays

CT-C, CT-S, CT-D



- From economic to high end
- A reliable solution for every application
- World wide approvals and support

—
Available in three different ranges to cover every application, CT range time relays are used to provide reliable timing functions worldwide. They have proven their excellent functionality in daily use under the toughest conditions.

Choose ABB as the partner for all your low voltage timing control needs to leverage our wide variety of product options. From economic to high-end solutions – the range offers maximum value.

Time relays

Table of contents

05	Time relays for industrial applications
11	CT-C range
23	CT-S range
41	Time relays for building applications
44	CT-D range
55	Timing functions



Time relays for industrial applications

Table of contents

06	Offer overview
07	Type selection
09	Applications
11	CT-C range
23	CT-S range

Time relays for industrial applications

Offer overview



CT-C: the compact range

The CT-C range combines lower cost with higher value and performance by offering essential functions in a space-saving 17.5 mm housing. The range offers a choice of 11 devices, including single and multifunctional types, with timing functions that range from 0.05 seconds to 100 hours. Equipped with a wide voltage range, the CT-C range is suitable for a huge variety of applications worldwide.

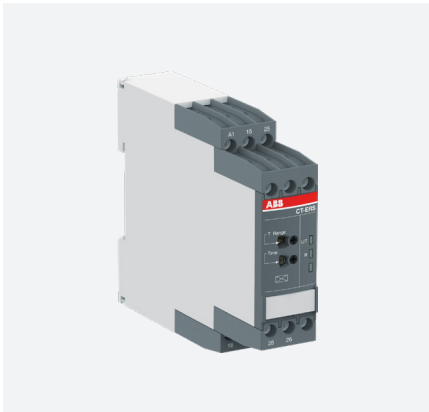









CT-S: the high-performance range

The advanced CT-S range is ABB's universal range of electronic timers. It includes 22 single-function devices and 16 multifunction time relays, offering flexibility in operation with up to 13 functions. The devices feature seven or ten time ranges, adjustable from 0.05 seconds to 300 hours. Additionally, every device is available in two different connection technologies: familiar double-chamber cage connection terminals (screw terminals) and ABB's vibration-resistant Easy Connect technology (push-in terminals).

Time relays for industrial applications

Type selection

	multi-functional	single-functional	multi-functional	single-functional
Timing function	CT-C		CT-S	
 ON-delay	CT-MFC	CT-ERC	CT-MVS, CT-MFS, CT-MBS, CT-WBS	CT-ERS
 OFF-delay	CT-MFC	CT-AHC	CT-MVS, CT-MFS, CT-MBS	CT-APS, CT-AHS, CT-ARS
 ON- and OFF-delay			CT-MVS, CT-MXS, CT-MFS, CT-MBS	
 Impulse-ON	CT-MFC	CT-VWC	CT-MVS, CT-MFS, CT-MBS, CT-WBS	
 Impulse-OFF	CT-MFC		CT-MVS, CT-MFS, CT-MBS	
 Impulse-ON and OFF			CT-MXS	
 Flasher starting with ON	CT-MFC		CT-MFS, CT-MBS, CT-WBS	
 Flasher starting with OFF	CT-MFC		CT-MFS, CT-MBS, CT-WBS	
 Flasher starting with ON or OFF			CT-MVS	
 Pulse generator starting with ON or OFF		CT-TGC	CT-MXS	
 Pulse former	CT-MFC		CT-MVS, CT-MFS, CT-MBS	
 Star-delta change-over		CT-SDC, CT-SAC		CT-SDS
 Star-delta change-over with impulse			CT-MVS.2x, CT-MFS, CT-MBS	
 further functions (depending on device)			CT-MVS, CT-MXS, CT-MFS, CT-MBS, CT-WBS	

A detailed explanation of the different timing functions can be found in the chapter "Timing functions".

Synonyms

Used expression	Alternative expression(s)
1 c/o contact	SPDT
2 c/o contacts	DPDT
voltage-related	wet / non-floating
volt-free	dry / floating

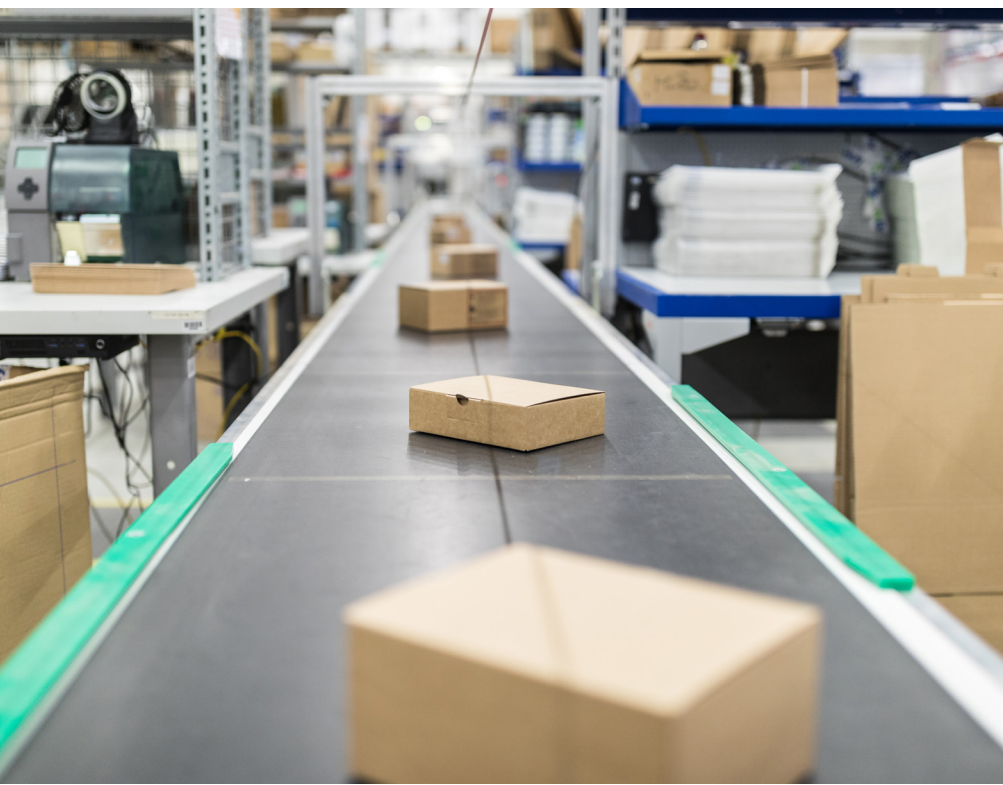

Time relays for industrial applications

Applications

ABB offers a wide selection of time relays – from economic to high-end – to suit every application for businesses worldwide. ABB time relays provide simple, reliable and economical control solutions in all types of panel. They are typically used in industrial applications and OEM equipment, providing time-delayed switching to start a motor, control a load or manage a process.



Remote control of time delays with a remote potentiometer.



Cyclic switching of machinery, for example the weekly startup of a fan to prevent them sticking or the flushing of pipes to keep them clear.



Lighting control, for example the delayed switching of multiple rows of lamps in production facilities or greenhouses.



Time controlled start up or shut down of machinery equipment, for example the delayed switch off of conveyor belts or the successive shut down of a plant.



Alarm triggering in case of fault detection, for example to allow the flashing of a lamp in industrial applications or rolling stock.



Star-delta motor starting to reduce starting current with changeover delay to prevent interphase short-circuits.

Have the perfect timing everywhere with ABB's time relays:

- Control panels
- Pump controls
- Star-delta motor starting
- Movable equipment e.g. cranes
- Machine tools
- Automatic doors
- Car park barriers
- Assembly machines
- HVAC
- Compressor controls
- Transportation
- Industrial refrigeration
- Packaging machines
- Baking ovens
- Water and wastewater
- Wind
- Industrial cleaning processes



CT-C range

Table of contents

12	Benefits and advantages
14	Selection table
15	Ordering details
16	Technical data
19	Technical diagrams

CT-C range

Benefits and advantages



The CT-C range combines lower cost with higher value and performance by offering essential functions in a 17.5 mm housing, freeing up room in any control cabinet. The range includes 11 devices, offering both single and multifunctional types, with a time range from 0.05 seconds to 100 hours. Equipped with wide voltage ranges, CT-C time relays allow for use across a huge variety of applications worldwide.

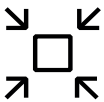

Space savings

With a width of just 17.5 mm, the CT-C range is 22% smaller than standard industrial housings for time relays. Its reduced overall footprint saves space in control cabinets. For more flexibility both 1 c/o and 2 c/o output versions are offered in the compact housing.



Cost effective solution

The CT-C range is an economical range that combines lower cost with higher value and performance. It suits basic applications where a time relay is needed, while offering improved functionality in each device.



Optimized logistics

By combining more functions into each device, the CT-C range makes it possible to reduce stock by up to 75% compared to other ranges. All devices in the CT-C range offer a wide supply voltage range as well as a wide time setting range from 0.05 seconds to 100 hours. This significantly reduces order code variance, making the range more compact with just 11 order codes covering every requirement.

CT-C range

Operating controls



Connection terminals
Wide terminal spacing makes wiring connections easier:
2 x 1.5 mm² (2 x 16 AWG) with wire end ferrules or 2 x 2.5 mm² (2 x 14 AWG) without ferrules.



Preselection of the time range



Direct reading scales
Direct setting of the time delay without any additional calculation provides accurate time delay adjustment.



Selection of the timing function

- ON-delay
- OFF-delay with aux. voltage
- Impulse-ON
- Impulse-OFF with aux. voltage
- Flasher starting with ON
- Flasher starting with OFF
- Pulse former

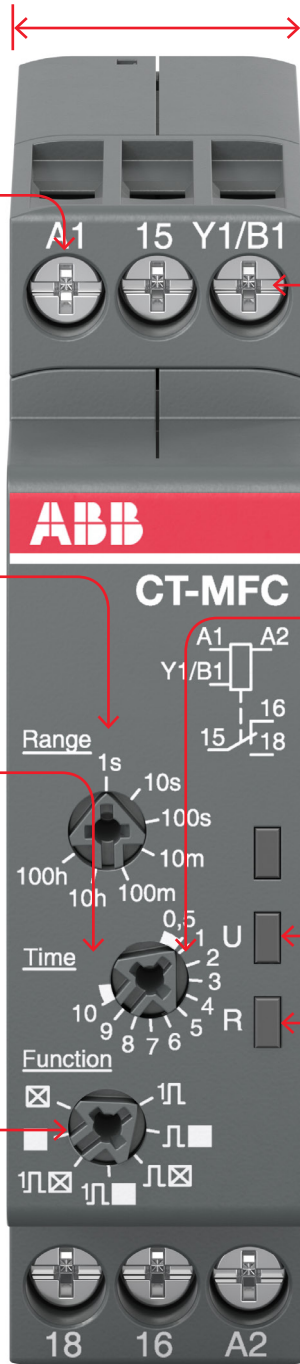

Width 17.5 mm
With a width of just 17.5mm, CT-C time relays are ideal for installations with limited space.

Control input to start timing



Fine adjustment of the time delay



LEDs for status indication
All actual operational states are displayed by front-facing LEDs, simplifying commissioning and troubleshooting.

- U - green LED:
 control supply voltage applied / timing
- R, R1, R2 - yellow LED:
 output relay energized

CT-C range

Ordering details



2CDC251030V0018

CT-MFC.12



2CDC251025V0018

CT-ERC.22

- Control input with voltage-related triggering
- No triggering

Description

The CT-C range combines lower cost with higher value and performance in a slim 17.5 mm-wide housing. All relays have a wide time setting range from 0.05 seconds up to 100 hours. Combined with a wide voltage range they are the perfect choice for applications worldwide.

Ordering details

Timing function	Rated control supply voltage	Time ranges	Control input	Output	Type	Order code	Weight (1 pc) kg (lb)
Multi ¹⁾	24-240 V AC 24-48 V DC	7 (0.05 s - 100 h)	■	1 c/o	CT-MFC.12	1SVR508020R0000	0.060 (0.132)
Multi ¹⁾	12-240 V AC/DC	7 (0.05 s - 100 h)	■	2 c/o	CT-MFC.21	1SVR508020R1100	0.065 (0.143)
ON-delay	24-240 V AC 24-48 V DC	7 (0.05 s - 100 h)	-	1 c/o	CT-ERC.12	1SVR508100R0000	0.060 (0.132)
			-	2 c/o	CT-ERC.22	1SVR508100R0100	0.065 (0.143)
OFF-delay			■	1 c/o	CT-AHC.12	1SVR508110R0000	0.060 (0.132)
			■	2 c/o	CT-AHC.22	1SVR508110R0100	0.065 (0.143)
Impulse-ON			-	1 c/o	CT-VWC.12	1SVR508130R0000	0.060 (0.132)
Pulse generator		2×7 (0.05 s - 100 h)	■		CT-TGC.12 ²⁾	1SVR508160R0000	0.060 (0.132)
			■	2 c/o	CT-TGC.22 ²⁾	1SVR508160R0100	0.065 (0.143)
Star-delta change-over		4 (0.05 s - 10 min)	-	2 n/o	CT-SDC.22 ³⁾	1SVR508211R0100	0.065 (0.143)
			-		CT-SAC.22 ⁴⁾	1SVR508210R0100	

¹⁾ Functions: ON-delay, OFF-delay with auxiliary voltage, Impulse-ON, Impulse-OFF with auxiliary voltage, Flasher starting with ON, Flasher starting with OFF, Pulse former

²⁾ ON and OFF times adjustable independently: 2 x 7 time ranges 0.05 s - 100 h



³⁾ Transition time 50 ms fixed

⁴⁾ Transition time adjustable

CT-C range

Technical data

Data at $T_a = 25\text{ °C}$ and rated values, unless otherwise indicated

	CT-C with 1 c/o contact	CT-C with 2 c/o contacts	CT-MFC.21
Input circuit - Supply circuit			
Rated control supply voltage U_s	24-240 V AC / 24-48 V DC		12-240 V AC/DC
Rated control supply voltage U_s tolerance	-15...+10 %		
Rated frequency	DC or 50/60 Hz		
Frequency range AC	47-63 Hz		
Typical power consumption	max. 3.5 VA		
Power failure buffering time	min. 20 ms		
Release voltage	> 10 % of the minimum rated control supply voltage U_s		
Input circuit - Control circuit			
Control input, control function	A1-Y1/B1	start timing external	
Kind of triggering	voltage-related triggering		
Resistance to reverse polarity	yes		
Parallel load / polarized	yes / yes		
Maximum cable length to the control inputs	50 m - 100 pF/m		
Minimum control pulse length	20 ms		
Control voltage potential	see rated control supply voltage		
Timing circuit			
Time ranges	7 time ranges 0.05 s - 100 h	1.) 0.05-1 s 2.) 0.5-10 s 3.) 5-100 s 4.) 0.5-10 min 5.) 5-100 min 6.) 0.5-10 h 7.) 5-100 h	
	4 time ranges 0.05 s - 10 min (CT-SDC, CT-SAC)	1.) 0.05-1 s 2.) 0.5-10 s 3.) 5-100 s 4.) 0.5-10 min	
Recovery time	< 50 ms		
Accuracy within the rated control supply voltage tolerance	$\Delta t < 0.005\ % / V$		
Accuracy within the temperature range	$\Delta t < 0.06\ % / \text{°C}$		
Repeat accuracy (constant parameters)	$\Delta t < \pm 0.5\ %$		
Setting accuracy of time delay	$\pm 10\%$ of full-scale value		
Star-delta transition time	CT-SDC / CT-SAC	fixed 50 ms / adjustable: 20 ms, 30 ms, 40 ms, 50 ms, 60 ms, 80 ms or 100 ms	
Star-delta transition time tolerance	CT-SDC / CT-SAC	$\pm 3\ ms$	
Indication of operational states			
Control supply voltage / timing	U: green LED	 : control supply voltage applied  : timing	
Relay energized	R, R1, R2: yellow LED	 : output relay energized	
Operating elements and controls			
Adjustment of the time range	front-face rotary switch, direct reading scales		
Fine adjustment of the time value	front-face potentiometer		
Preselection of the timing function at multifunction devices	front-face rotary switch, direct reading scales		
Adjustment of the transition time	CT-SAC	front-face potentiometer	

CT-C range

Technical data

		CT-C with 1 c/o contact	CT-C with 2 c/o contacts	CT-MFC.21
Output circuit				
Kind of output	15-16/18	Relay, 1 c/o contact	-	
	15-16/18; 25-26/28	-	Relay, 2 c/o contacts	
	17-18; 17-28		Relay, 2 n/o contacts (CT-SDC, CT-SAC)	
Contact material		AgNi alloy, Cd free		
Rated operational voltage U_e		250 V		
Minimum switching voltage / minimum switching current		12 V / 100 mA		
Maximum switching voltage / maximum switching current		250 V AC / 6 A	250 V AC / 5 A	
Rated operational current I_e	AC-12 (resistive) at 230 V	4 A	4 A	
	AC-15 (inductive) at 230 V	3 A	3 A	n/o: 3 A n/c: 0.75 A
	DC-12 (resistive) at 24 V	4 A	4 A	
	DC-13 (inductive) at 24 V	2 A	2 A	1 A
AC rating (UL 508)	utilization category (Control Circuit Rating Code)	B 300		n/o: B 300 n/c: C 300
	max. rated operational voltage	300 V AC		
	maximum continuous thermal current at B300	5 A		n/o: 5 A
	maximum continuous thermal current at C300	-		n/c: 2.5 A
	max. making/breaking apparent power at B300	3600 VA / 360 VA		n/o: 3600/360 VA
	max. making/breaking apparent power at C300	-		n/c: 1800/180 VA
Mechanical lifetime		30 x 10 ⁶ switching cycles		
Electrical lifetime		0.1 x 10 ⁶ switching cycles		
Max. fuse rating to achieve short-circuit protection	n/c contact	6 A fast-acting		
	n/o contact	10 A fast-acting		6 A fast-acting
General data				
Mean time between failures (MTBF)		on request		
Duty time		100%		
Dimensions		see 'Dimensional drawings'		
Mounting		DIN rail (IEC/EN 60715), snap-mounting without any tool		
Mounting position		any		
Minimum distance to other units	horizontal / vertical	no / no		
Degree of protection	housing / terminals	IP50 / IP20		
Electrical connection				
Connecting capacity	fine-stranded with(out) wire and ferrule	2 x 0.5-1.5 mm ² (2 x 20-16 AWG)		
		1 x 0.5-2.5 mm ² (1 x 20-14 AWG)		
	rigid	2 x 0.5-1.5 mm ² (2 x 20-16 AWG)		
		1 x 0.5-4 mm ² (1 x 20-12 AWG)		
Stripping length		7 mm (0.28 in)		
Tightening torque		0.5-0.8 Nm (4.43-7.08 lb.in)		
Environmental data				
Ambient temperature range	operation / storage	-20 ... +60 °C / -40 ... +85 °C		
Climatic class	EC/EN 60068-2-30	3K3		
Relative humidity range		25-85%		
Vibration, sinusoidal	IEC/EN 60068-2-6	20 m/s ² ; 10 cycles, 10...150...10 Hz		
Shock (half-sine)	IEC/EN 60068-2-27	150 m/s ² , 11 ms		

CT-C range

Technical data

		CT-C with 1 c/o contact	CT-C with 2 c/o contacts	CT-MFC.21
Isolation data				
Rated insulation voltage U_i	input circuit / output circuit	300 V		
	output circuit 1 / output circuit 2	not available	300 V	300 V
Rated impulse withstand voltage U_{imp}	between all isolated circuits	4 kV; 1.2/50 μ s		
Power-frequency withstand voltage test(test voltage)	between all isolated circuits	2.5 kV; 50 Hz; 60 s		
Basic insulation (IEC/EN 61140)	input circuit / output circuit	300 V		
Protective separation (IEC/EN 61140, EN 50178)	input circuit / output circuit	250 V		
Pollution degree		3		
Overvoltage category		III		
Standards / Directives				
Standards		IEC/EN 61812-1		
Low Voltage Directive		2014/35/EU		
EMC Directive		2014/30/EU		
RoHS Directive		2011/65/EU		
Electromagnetic compatibility				
Interference immunity to		IEC/EN 61000-6-2		
electrostatic discharge	IEC/EN 61000-4-2	Level 3 (6 kV / 8 kV)		
radiated, radio-frequency, electromagnetic field	IEC/EN 61000-4-3	Level 3 (10 V / m)		
electrical fast transient / burst	IEC/EN 61000-4-4	Level 3 (2 kV / 5 kHz)		
surge	IEC/EN 61000-4-5	Level 4 (2 kV L-L)		
conducted disturbances, induced by radio-frequency fields	IEC/EN 61000-4-6	Level 3 (10 V)		
Interference emission		IEC/EN 61000-6-3		
high-frequency radiated	IEC/CISPR 22, EN 55022	Class B		
high-frequency conducted	IEC/CISPR 22, EN 55022	Class B		

CT-C range

Technical diagrams

Example of application - Star-delta changeover

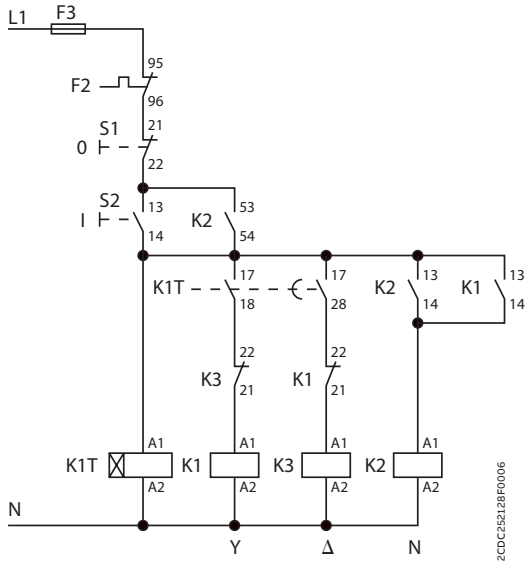

2CDC252128F0006

Control circuit diagram

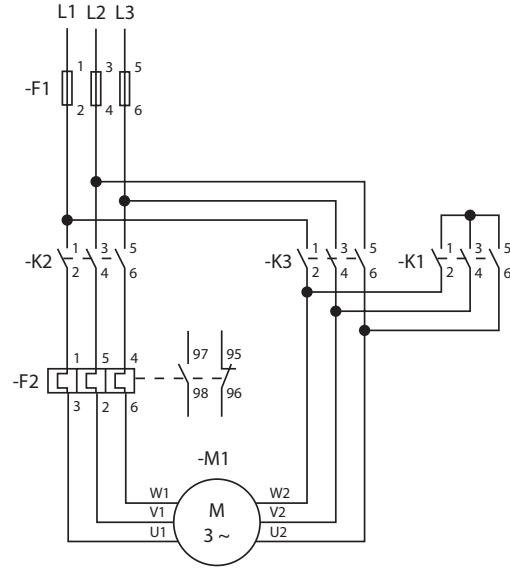

2CDC253009F0012

Power circuit diagram

CT-C range

Technical diagrams

Connection diagrams

CT-MFC.21

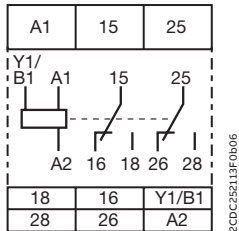

A1-A2	Supply: 12-240 V AC/DC
A1-Y1/B1	Control input
15-16/18	1st c/o contact
25-26/28	2nd c/o contact

CT-MFC.12

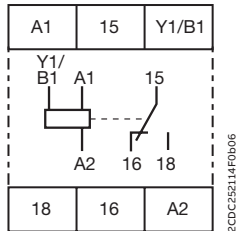

A1-A2	Supply: 24-48 V DC or 24-240 V AC
A1-Y1/B1	Control input
15-16/18	1st c/o contact

CT-ERC.22

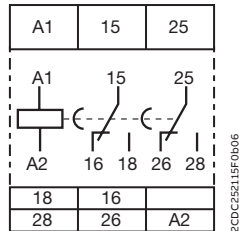

A1-A2	Supply: 24-48 V DC or 24-240 V AC
15-16/18	1st c/o contact
25-26/28	2nd c/o contact

CT-ERC.12

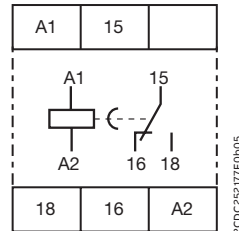

A1-A2	Supply: 24-48 V DC or 24-240 V AC
15-16/18	1st c/o contact

CT-AHC.22

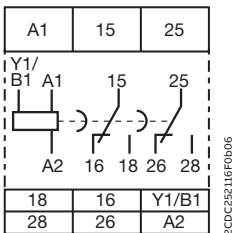

A1-A2	Supply: 24-48 V DC or 24- 240 V AC
A1-Y1/B1	Control input
15-16/18	1st c/o contact
25-26/28	2nd c/o contact

CT-AHC.12

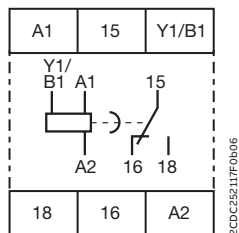

A1-A2	Supply: 24-48 V DC or 24- 240 V AC
A1-Y1/B1	Control input
15-16/18	1st c/o contact

CT-VWC.12

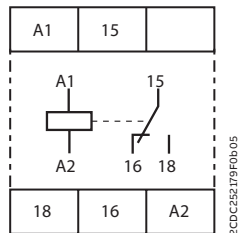

A1-A2	Supply: 24-48 V DC or 24- 240 V AC
15-16/18	1st c/o contact

CT-TGC.22

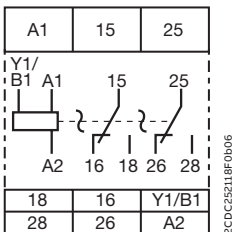

A1-A2	Supply: 24-48 V DC or 24-240 V AC
A1-Y1/B1	Control input
15-16/18	1st c/o contact
25-26/28	2nd c/o contact

CT-TGC.12

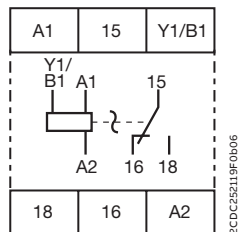

A1-A2	Supply: 24-48 V DC or 24- 240 V AC
A1-Y1/B1	Control input
15-16/18	1st c/o contact

CT-SDC.22

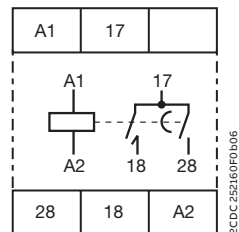

A1-A2	Supply: 24-48 V DC or 24-240 V AC
17-18	1st n/o contact (star contactor)
17-28	2nd n/o contact (delta contactor)

CT-SAC.22

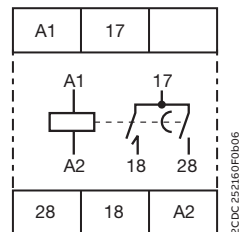

A1-A2	Supply: 24-48 V DC or 24-240 V AC
17-18	1st n/o contact (star contactor)
17-28	2nd n/o contact (delta contactor)

CT-C range

Technical diagrams

Load limit curves

AC load (resistive)

CT-C.1x

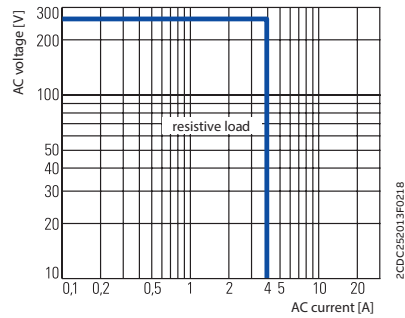

CT-C.2x

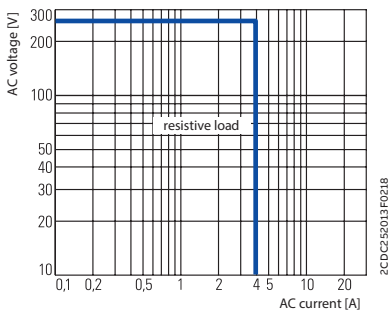

DC load (resistive)

CT-C.1x

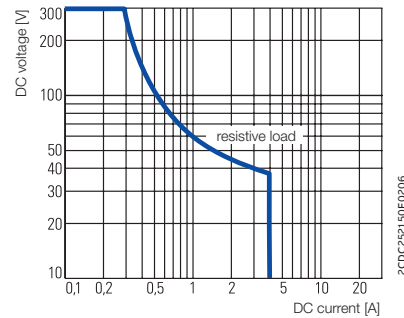

CT-C.2x

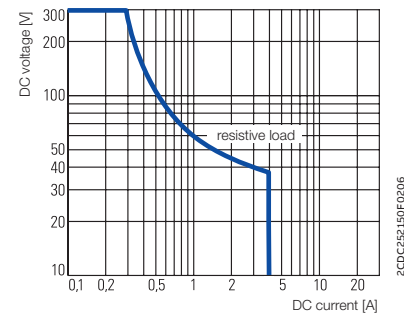

Derating factor F for inductive AC load

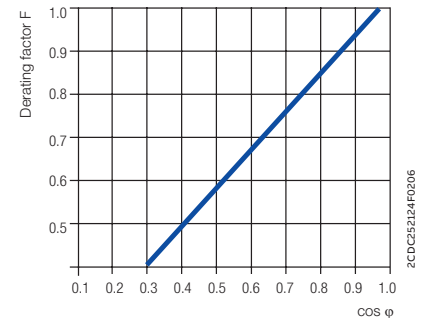

Contact lifetime

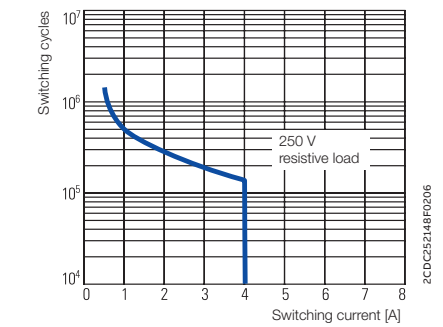

Wiring notes for devices with control input

A parallel load to the control input is possible

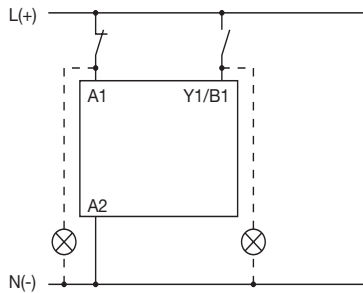

Dimensional drawings

CT-C devices with 1 c/o contact or 2 n/o contacts

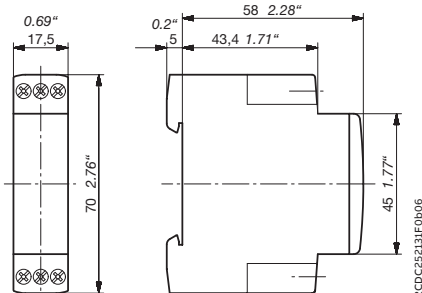

CT-C devices with 2 c/o contacts

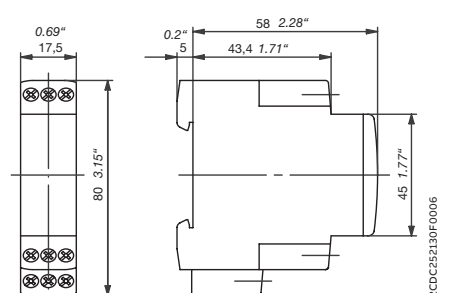

Dimensions in mm, inches



CT-S range

Table of contents

24	Benefits and advantages
28	Selection table
29	Ordering details - multifunctional devices
30	Ordering details - singlefunctional devices
31	Ordering details - Accessories
32	Technical data
35	Technical diagrams

CT-S range

Benefits and advantages



The advanced CT-S range includes 22 single-function devices and 16 multifunction timers with up to 13 functions. The devices feature seven or ten time ranges, which are adjustable from 0.05 seconds to 300 hours. Every device is available in two different connection technologies: double-chamber cage connection terminals or ABB's vibration-resistant Push-in Technology.



Improve installation efficiency

The CT-S range allows simple tool free mounting and demounting on the DIN rail. Thanks to the easy connect and the double-chamber cage connection technology simplified wiring with or without wire end ferrules is no problem. Both allow simple and easy installation, even in case of different cable diameters.



Reliable in harsh conditions

The CT-S range's extended features make it especially suited for harsh environments. The housing material has the highest UL fire protection classification. All functions are available with Push-in terminals, making operations in environments with high vibrations possible without retightening. Additionally, the CT-S range offers devices with an extended temperature range, running operations in temperatures as low as -40 °C effortlessly. Specific types are tested according to the latest rail industry standards, making them a perfect solution for rolling stock and other rail applications.



Global availability

Every device in the CT-S range is designed to provide a wide supply voltage range, making global differences irrelevant. Additionally, the CT-S range meets a broad range of standards and requirements. Together with ABB's global support and sales network, using CT-S gives customers the confidence of worldwide sourcing – no matter where they build, install or operate their equipment.

CT-S range

Operating controls

Control input
Starts and pauses timing.



Preselection of time range
Direct assignment of the pre-selected time range to the fine adjustment potentiometer scale by multicolor scales



Fine adjustment of the time delay



Selection of the timing function

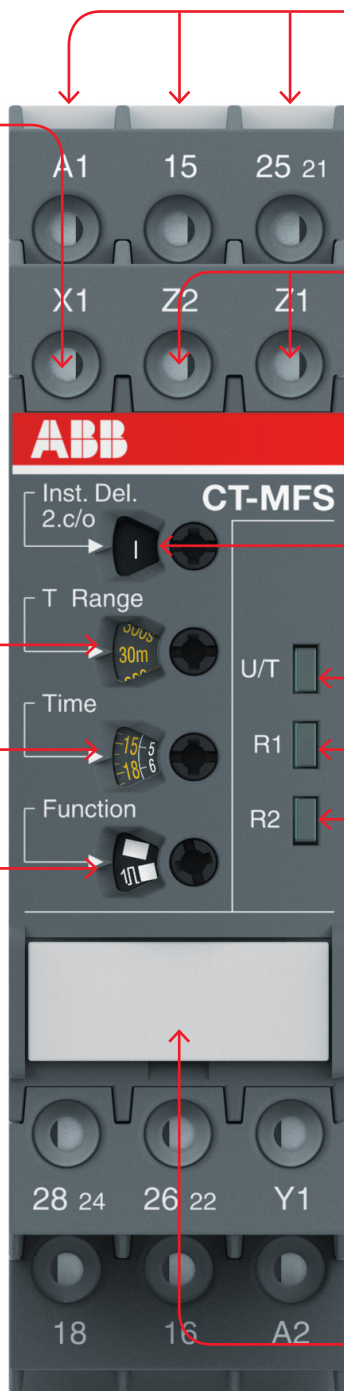



Connection terminals
Screw or push-in connection available.

Remote potentiometer connection possible

2nd contact selectable as an instantaneous contact



LEDs for status indication
All actual operational states are displayed by front-face LEDs, thus simplifying commissioning and troubleshooting.

- U/T - green LED:
 control supply voltage applied /
 timing
- R, R1, R2 - yellow LED:
 Output relay energized



Integrated marker label
Integrated marker labels allow the product to be marked quickly and simply. No additional marker labels are required.

CT-S range

Benefits and advantages

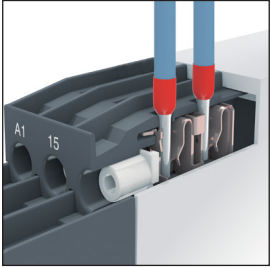

2CDC253026F0011

01 Tool-free mounting of wires

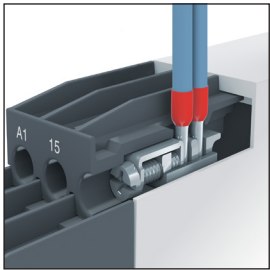

2CDC253026F0011

02 Wiring of double-chamber cage connection terminals with screw driver

Easy Connect Technology

Tool-free wiring and excellent vibration resistance. Easy Connect (Push-in terminals) provide connection of wires up to $2 \times 0.5 - 1.5 \text{ mm}^2$ ($2 \times 20 - 16 \text{ AWG}$), rigid or fine-strand with or without wire end ferrules. The extended type designators for products with push-in terminals are indicated by a **P** following the extended type designator e.g. CT-xxS.xx**P**.

Double-chamber cage connection terminals

According to IEC/EN 60947-1 double-chamber cage connection terminals provide connection of wires up to $2 \times 0.5 - 2.5 \text{ mm}^2$ ($2 \times 20 - 14 \text{ AWG}$) rigid or fine-strand, with or without wire end ferrules. Thanks to the technology, using different cable diameters in one terminal is easy and simple to install. Potential distribution does not require additional terminals. The extended type designators for products with double-chamber cage connection terminals (screw terminals) are indicated by an **S** following the extended type designator, e.g. CT-xxS.xx**S**.



CT-S range

Made for the most extreme conditions

Selected products of the CT-S range comply to the latest rail standards like EN50155. Designed for harsh environments, not only are standard screw type terminals offered – push-in terminals with excellent vibration resistance are also available. Perfect for use in rolling stock.



Conductor car

- In the event of the press switch not switching off the auxiliary release pumps of the breaking system, a delayed switch off is triggered by the time relays
- While switching between hold-on and start-up coil on the main switch, a time relay can prolong the pulse
- The reliable and safe functionality of the compressor is essential for trains

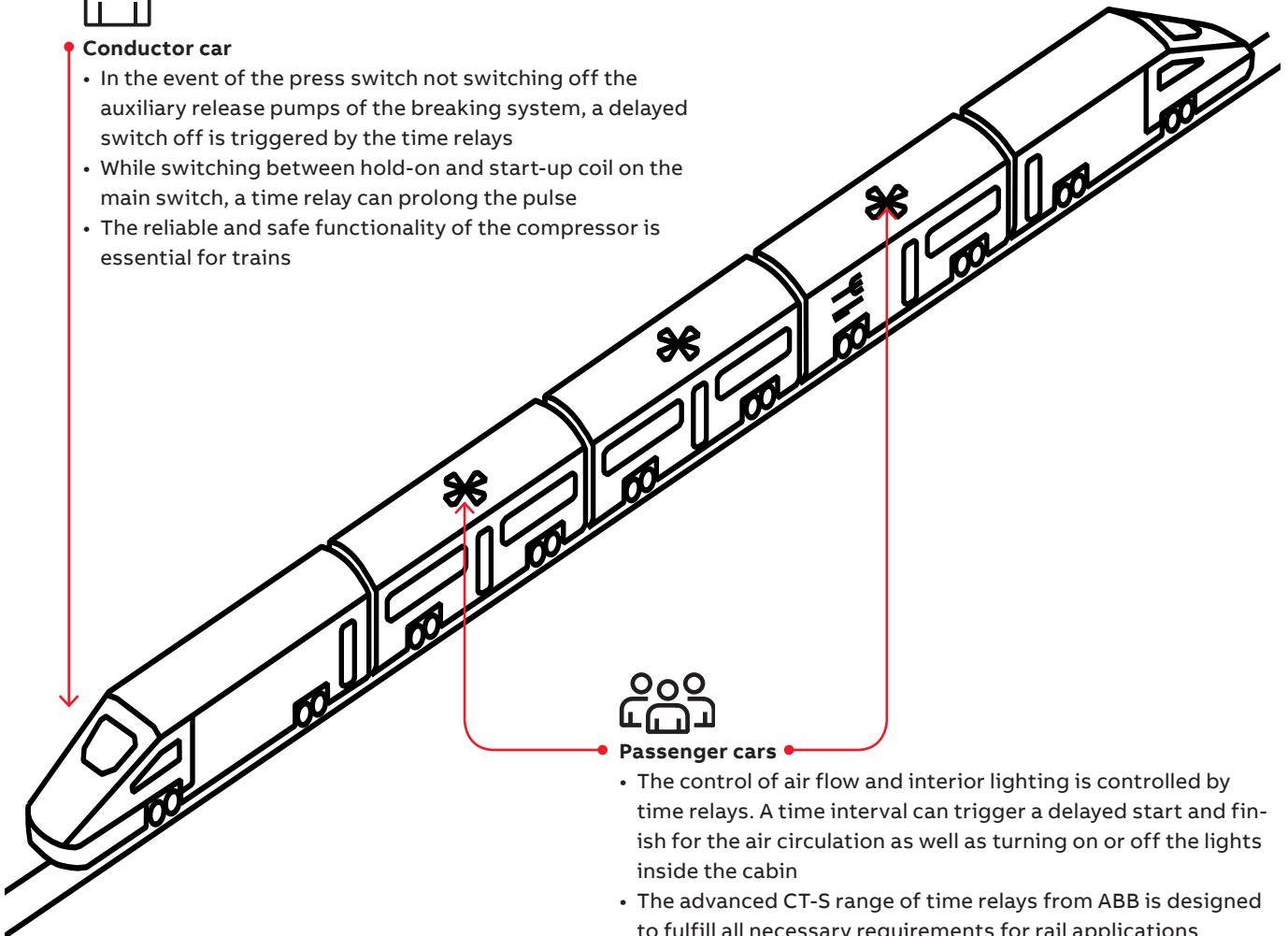

Passenger cars

- The control of air flow and interior lighting is controlled by time relays. A time interval can trigger a delayed start and finish for the air circulation as well as turning on or off the lights inside the cabin
- The advanced CT-S range of time relays from ABB is designed to fulfill all necessary requirements for rail applications

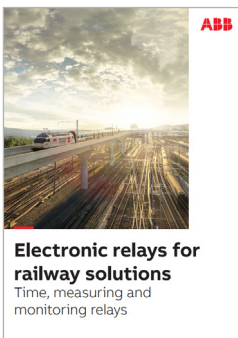

Electronic relays for railway solutions brochure

For more information about time relays in rolling stock applications visit:

new.abb.com/low-voltage/products/electronicrelays

or scan the QR code



CT-S range

Ordering details - multifunctional devices

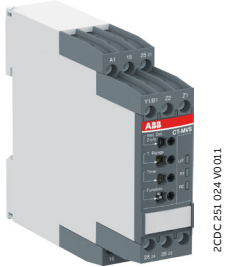

CT-MVS.21P

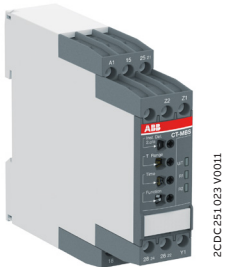

CT-MBS.22P

- Control input with voltage-related triggering
- Control input with volt-free triggering
- / □ Two control input with volt-free triggering
- No triggering

Description

The high-performance CT-S range is ideally suited for universal use and is available with two different connection technologies:

- Double-chamber cage connection terminals (Screw terminals)
- Easy Connect Technology (Push-in terminals)

Ordering details

Timing function ⁵⁾	Rated control supply voltage	Time ranges	Control input	Output	Type	Order code	Weight (1 pc) kg (lb)
Multi	24- 240 V AC/DC	10 (0.05 s - 300 h)	■	2 c/o	CT-MVS.21S ^{1) 2) 3)}	1SVR730020R0200	0.148 (0.326)
					CT-MVS.21P ^{1) 2) 3)}	1SVR740020R0200	0.136 (0.30)
	CT-MVS.22S				1SVR730020R3300	0.142 (0.313)	
	CT-MVS.22P				1SVR740020R3300	0.131 (0.289)	
	CT-MVS.23S				1SVR730021R2300	0.144 (0.317)	
	CT-MVS.23P				1SVR740021R2300	0.133 (0.293)	
Multi	24-48 V DC, 24-240 V AC	10 (0.05 s - 300 h)	■	1 c/o	CT-MVS.12S	1SVR730020R3100	0.107 (0.236)
					CT-MVS.12P	1SVR740020R3100	0.102 (0.225)
Multi	24-48 V DC, 24-240 V AC	2×10 (0.05 s - 300 h)	■	2 c/o	CT-MXS.22S ⁴⁾	1SVR730030R3300	0.142 (0.313)
					CT-MXS.22P ⁴⁾	1SVR740030R3300	0.131 (0.289)
Multi	24- 240 V AC/DC	10 (0.05 s - 300 h)	□ / □	2 c/o	CT-MFS.21S ^{1) 2) 3)}	1SVR730010R0200	0.145 (0.32)
					CT-MFS.21P ^{1) 2) 3)}	1SVR740010R0200	0.133 (0.293)
	24-48 V DC, 24-240 V AC		□	CT-MBS.22S ^{2) 3)}	1SVR730010R3200	0.14 (0.309)	
				CT-MBS.22P ^{2) 3)}	1SVR740010R3200	0.129 (0.284)	
Multi	24-48 V DC, 24-240 V AC	10 (0.05 s - 300 h)	-	2 c/o	CT-WBS.22S	1SVR730040R3300	0.123 (0.271)
					CT-WBS.22P	1SVR740040R3300	0.115 (0.254)

¹⁾ Extended temperature range -40 °C
²⁾ Remote potentiometer connection
³⁾ 2nd c/o contact selectable as instantaneous contact
⁴⁾ 2 remote potentiometer connections
⁵⁾ See selection table on previous page

S: Screw connection
 P: Push-in / easy connect

CT-S range

Ordering details - singlefunctional devices

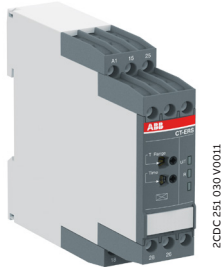

CT-ERS.21P

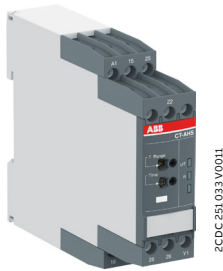

CT-AHS.22P

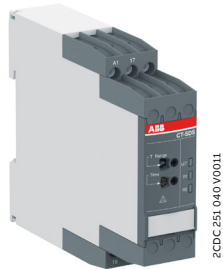

CT-SDS.23P

- Control input with voltage-related triggering
- Control input with volt-free triggering
- /□ Two control input with volt-free triggering
- No triggering

Ordering details

Timing function	Rated control supply voltage	Time ranges	Control input	Output	Type	Order code	Weight (1 pc) kg (lb)	
ON-delay	24-240 V AC/DC	10 (0.05 s - 300 h)	-	2 c/o	CT-ERS.21S ¹⁾	1SVR730100R0300	0.13 (0.287)	
					CT-ERS.21P ¹⁾	1SVR740100R0300	0.121 (0.267)	
	CT-ERS.22S			1SVR730100R3300	0.121 (0.267)			
	CT-ERS.22P			1SVR740100R3300	0.113 (0.249)			
	-		1 c/o	CT-ERS.12S	1SVR730100R3100	0.106 (0.234)		
				CT-ERS.12P	1SVR740100R3100	0.101 (0.222)		
OFF-delay	24-240 V AC/DC	10 (0.05 s - 300 h)	■	2 c/o	CT-APS.21S ¹⁾	1SVR730180R0300	0.146 (0.322)	
					CT-APS.21P ¹⁾	1SVR740180R0300	0.125 (0.276)	
				CT-APS.22S	1SVR730180R3300	0.138 (0.304)		
				CT-APS.22P	1SVR740180R3300	0.127 (0.28)		
	-		1 c/o	CT-APS.12S	1SVR730180R3100	0.109 (0.24)		
				CT-APS.12P	1SVR740180R3100	0.103 (0.227)		
	24-48 V DC, 24-240 V AC		□	2 c/o	-	CT-AHS.22S	1SVR730110R3300	0.136 (0.30)
						CT-AHS.22P	1SVR740110R3300	0.125 (0.276)
-		1 c/o		CT-ARS.11S	1SVR730120R3100	0.106 (0.234)		
				CT-ARS.11P	1SVR740120R3100	0.10 (0.22)		
OFF-delay ²⁾	24-240 V AC/DC	7 (0.05 s - 10 min)	-	2 c/o	CT-ARS.21S	1SVR730120R3300	0.124 (0.273)	
					CT-ARS.21P	1SVR740120R3300	0.115 (0.254)	
				-	2 n/o	CT-SDS.22S	1SVR730210R3300	0.114 (0.251)
						CT-SDS.22P	1SVR740210R3300	0.108 (0.238)
Star-delta change-over ³⁾	24-48 V DC, 24-240 V AC	7 (0.05 s - 10 min)	-	-	CT-SDS.23S	1SVR730211R2300	0.118 (0.26)	
					CT-SDS.23P	1SVR740211R2300	0.112 (0.247)	
	380-440 V AC							

¹⁾ Extended temperature range -40 °C

²⁾ Without auxiliary voltage

³⁾ 50 ms transition time

S: Screw connection
P: Push-in / easy connect

CT-S range

Ordering details - Accessories



MT-x50B

1SFC151139V0001

The CT-S range offers the possibility of using accessories such as a remote potentiometer to adjust the time delay or a sealable, transparent cover to protect against unauthorized changes of time and threshold values.

Remote potentiometer

50 kΩ ±20 % - 0.2 Ω, degree of protection IP66

Material	Diameter in mm	Type	Order code	Pack.- unit pieces	Weight 1 piece g / oz
Plastic, black	22.5	MT-150B	1SFA611410R1506	1	0.040
Plastic, chrome	22.5	MT-250B	1SFA611410R2506	1	0.040
Metal, chrome	22.5	MT-350B	1SFA611410R3506	1	0.048

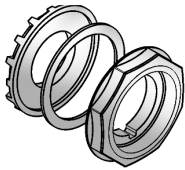

30 mm adapters

2CDC252 042 F0009

30 mm adapter for attaching the potentiometer 22 mm in 30 mm mounting hole

Material	Type	Order code	Pack.- unit pieces	Weight 1 piece g / oz
Plastic, black	KA1-8029	1SFA616920R8029	1	
Metal, chrome	KA1-8030	1SFA616920R8030	1	

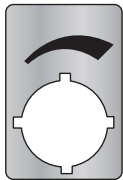

Marker label 29.6 x 44.5 mm

2CDC 252 043 F0209

Marker label

Caption	Type	Order code	Pack.- unit pieces	Weight 1 piece g / oz
Symbol (see illustration)	SK 615 562-87	GJD6155620R0087	1	0.002
Scale 0 - 10	SK 615 562-88	GJD6155620R0088	1	0.002
Scale 0 - 30	MA16-1060	1SFA611940R1060	1	0.002

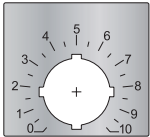

Marker label with scale 0-10
48.5 x 44.5 mm

2CDC 252 044 F0209

Accessories for CT-S

Description	Type	Order code	Pack.- unit pieces	Weight 1 piece g / oz
Adapter for screw mounting	ADP.01	1SVR430029R0100	1	0.018 (0.040)
Sealable transparent cover	COV.11	1SVR730005R0100	1	0.004 (0.009)
Marker label for devices w/o DIP switches	MAR.01	1SVR366017R0100	10	0.001 (0.002)
Marker label for devices with DIP switches	MAR.12	1SVR730006R0000	10	0.001 (0.002)

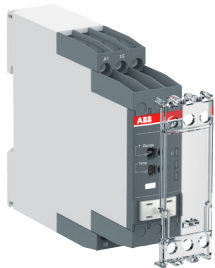

Sealable transparent cover
for CT-S in new housing

2CDC 255 006 S0011

CT-S range

Technical data





Data at $T_a = 25\text{ °C}$ and rated values, unless otherwise indicated

		CT-S
Input circuit - Supply circuit		
Rated control supply voltage U_s	CT-xxx.x1	24-240 V AC/DC
	CT-xxx.x2	24-48 V DC, 24-240 V AC
	CT-xxx.x3	380-440 V AC
Rated control supply voltage U_s tolerance		-15...+10 %
Rated frequency		DC or 50/60 Hz
Frequency range AC		47-63 Hz
Typical power consumption		max. 16 VA
Power failure buffering time	24 V DC	min. 15 ms
	230/400 V AC	min. 20 ms
Release voltage		> 10 % of the minimum rated control supply voltage U_s
Minimum energizing time		100 ms (CT-ARS)
Formatting time ¹⁾		5 min (CT-ARS)
Input circuit - Control circuit		
Kind of triggering	CT-MVS, CT-MXS, CT-APS	voltage-related triggering
Control input, Control function	A1-Y1/B1	start timing external
Parallel load / polarized		yes / no
Maximum cable length to the control input		50 m - 100 pF/m
Minimum control pulse length		20 ms
Control voltage potential		see rated control supply voltage
Current consumption of the control input	24 V DC	1.2 mA
	230 V AC	8 mA
	400 V AC	6 mA
Kind of triggering	CT-MFS, CT-MBS, CT-AHS	volt-free triggering
Control input, Control function	Y1-Z2	start timing external
	X1-Z2	pause timing / accumulative functions (CT-MFS)
Maximum switching current in the control circuit		1 mA
Maximum cable length to the control input		50 m - 100 pF/m
Minimum control pulse length		20 ms
No-load voltage at the control inputs		10-40 V DC
Remote potentiometer		
Remote potentiometer connections, resistance value	Z1-Z2	50 k Ω (CT-MFS, CT-MBS, CT-MVS.21, CT-MXS)
	Z3-Z2	50 k Ω (CT-MXS)
Maximum cable length to remote potentiometer		2 x 25 m, shielded with 100 pF/m
Shield connection		Z2
Timing circuit		
Time ranges	10 time ranges 0.05 s - 300 h	1.) 0.05-1 s 2.) 0.15-3 s 3.) 0.5-10 s 4.) 1.5-30 s 5.) 5-100 s 6.) 15-300 s 7.) 1.5-30 min 8.) 15-300 min 9.) 1.5-30 h 10.) 15-300 h
	7 time ranges 0.05 s - 10 min (CT-SDS, CT-ARS)	1.) 0.05-1 s 2.) 0.15-3 s 3.) 0.5-10 s 4.) 1.5-30 s 5.) 5-100 s 6.) 15-300 s 7.) 0.5-10 min
Recovery time	24-240 V AC/DC	< 50 ms
	24-48 V DC, 24-240 V AC	< 80 ms
	380-440 V AC	< 60 ms
Accuracy within the rated control supply voltage tolerance		$\Delta t < 0.004\%$ / V
Accuracy within the temperature range		$\Delta t < 0.03\%$ / °C
Repeat accuracy (constant parameters)		< $\pm 0.2\%$
Setting accuracy of time delay		$\pm 6\%$ of full-scale value
Star-delta transition time		fixed 50 ms (CT-SDS, CT-MBS, CT-MFS, CT-MVS.2x)
Star-delta transition time tolerance		$\pm 2\text{ ms}$

¹⁾ Prior to first commissioning and after a six-month stop in operation

CT-S range

Technical data

Indication of operational states			
Control supply voltage / timing	U/T: green LED	 : control supply voltage applied /  : timing	
Control supply voltage	U: green LED	 : control supply voltage applied	
Relay state	R, R1, R2: yellow LED	 : output relay energized	
Output circuit			
Kind of output	15-16/18	relay, 1 c/o contact	
	15-16/18; 25-26/28	relay, 2 c/o contacts	
	15-16/18; 25(21)-26(22)/28(24)	relay, 2 c/o contacts, 2nd c/o contact selectable as inst. contact	
	17-18; 17-28	relay, 2 n/o contacts (CT-SDS)	
Contact material		Cd-free, on request	
Rated operational voltage U _e	IEC/EN 60947-1	250 V	
Minimum switching voltage / minimum switching current		12 V / 100 mA	
Maximum switching voltage / maximum switching current		see load limit curves	
Rated operational current I _e	AC-12 (resistive) at 230 V	4 A	
	AC-15 (inductive) at 230 V	3 A	
	DC-12 (resistive) at 24 V	4 A	
	DC-13 (inductive) at 24 V	2 A (CT-ARS; 1.5 A)	
AC rating (UL 508)	utilization category (Control Circuit Rating Code)	B 300	
	max. rated operational voltage	300 V AC	
	maximum continuous thermal current at B300	5 A	
	max. making/breaking apparent power at B300	3600 VA / 360 VA	
Mechanical lifetime		30 x 10 ⁶ switching cycles	
Electrical lifetime	at AC-12, 230 V, 4 A	0.1 x 10 ⁶ switching cycles	
Frequency of operation	with/without load	360/72000 h ⁻¹ CT-ARS: 1200/18000 h ⁻¹	
Max. fuse rating to achieve short-circuit protection	n/c contact	6 A fast-acting	
	n/o contact	10 A fast-acting	
General data			
MTBF		on request	
Duty time		100%	
Dimensions		see 'Dimensional drawings'	
Mounting		DIN rail (IEC/EN 60715), snap-on mounting without any tool	
Mounting position		any	
Minimum distance to other units	vertical / horizontal	not necessary / not necessary	
Material of housing		UL 94 V-0	
Degree of protection	housing / terminals	IP50 / IP20	
Electrical connection			
Connecting capacity	fine-strand with(out) wire end ferrule	Screw connection technology	Easy Connect Technology (Push-in)
		1 x 0.5-2.5 mm ² (1 x 18-14 AWG) 2 x 0.5-1.5 mm ² (2 x 18-16 AWG)	2 x 0.5-1.5 mm ² (2 x 18-16 AWG)
	rigid	1 x 0.5-4 mm ² (1 x 20-12 AWG) 2 x 0.5-2.5 mm ² (2 x 20-14 AWG)	2 x 0.5-1.5 mm ² (2 x 20-16 AWG)
Stripping length		8 mm (0.32 in)	
Tightening torque		0.6-0.8 Nm (7.08 lb.in)	-

CT-S range

Technical data

Environmental data		
Ambient temperature ranges	operation / storage	-25...+60 °C / -40...+85 °C, -40...+60 °C / -40...+85 °C for CT-MVS.21, CT-MFS.21, CT-ERS.21, CT-APS.21
Relative humidity range		25 % to 85 %
Vibration, sinusoidal (IEC/EN 60068-2-6)	functioning	40 m/s ² , 10-58/60-150 Hz
	resistance	60 m/s ² , 10-58/60-150 Hz, 20 cycles
Vibration, seismic (IEC/EN 60068-3-3)	functioning	20 m/s ²
Shock, half-sine (IEC/EN 60068-2-27)	functioning	150 m/s ² , 11 ms, 3 shocks/direction
	resistance	300 m/s ² , 11 ms, 3 shocks/direction
Isolation data		CT-S with 1 c/o
Rated insulation voltage U _i	input circuit / output circuit	500 V
	output circuit 1 / output circuit 2	not available
Rated impulse withstand voltage U _{imp}	between all isolated circuits	4 kV; 1.2/50 μs except devices CT-xxx.23: input / output: 6 kV; 1.2/50 μs output 1 / output 2: 4 kV; 1.2/50 μs
	between all isolated circuits	2.0 kV; 50 Hz; 60 s
Power-frequency withstand voltage (test voltage)	between all isolated circuits	2.0 kV; 50 Hz; 60 s
Basic insulation (IEC/EN 61140)	input circuit / output circuit	500 V
Protective separation (IEC/EN 61140; EN 50178)	input circuit / output circuit	250 V
Pollution degree		3
Overvoltage category		III
Standards / Directives		
Standards		IEC/EN 61812-1
Low Voltage Directive		2014/35/EU
EMC Directive		2014/30/EU
RoHS Directive		2011/65/EU
Electromagnetic compatibility		
Interference immunity to		IEC/EN 61000-6-2
electrostatic discharge	IEC/EN 61000-4-2	Level 3, 6 kV / 8 kV
radiated, radio-frequency electromagnetic field	IEC/EN 61000-4-3	Level 3, 10 V/m (1 GHz) 3 V/m (2 GHz) 1 V/m (2.7 GHz)
electrical fast transient / burst	IEC/EN 61000-4-4	Level 3, 2 kV / 5 kHz
surge	IEC/EN 61000-4-5	Level 4, 2 kV A1-A2
conducted disturbances, induced by radio-frequency fields	IEC/EN 61000-4-6	Level 3, 10 V
harmonics and interharmonics	IEC/EN 61000-4-13	Class 3
Interference emission		IEC/EN 61000-6-3
high-frequency radiated	IEC/CISPR 22, EN 55022	Class B
high-frequency conducted	IEC/CISPR 22, EN 55022	Class B

CT-S range

Technical diagrams

DIP switch configuration CT-MXS.22x

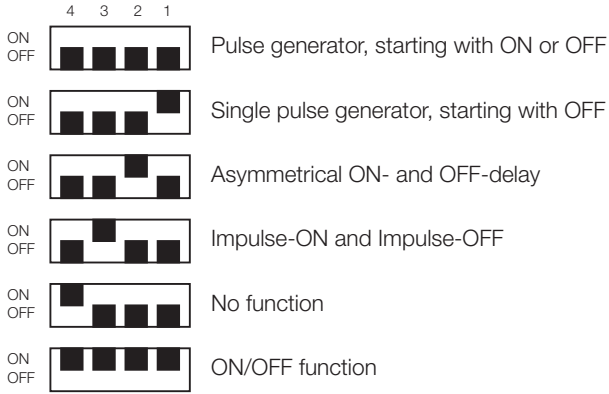

Default setting: all DIP switches in position OFF

Example of application - Star-delta chnangeover

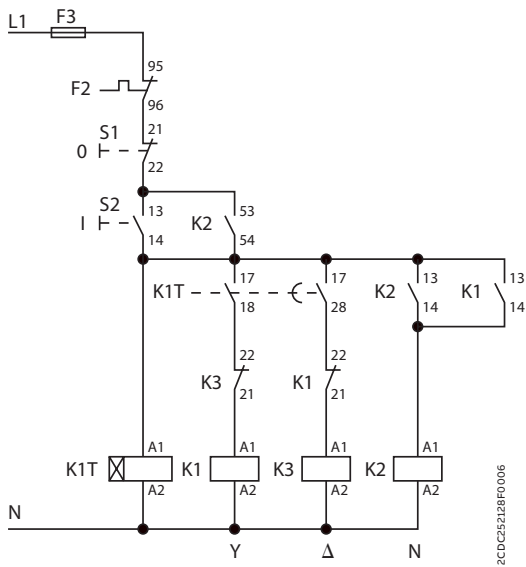

Control circuit diagram

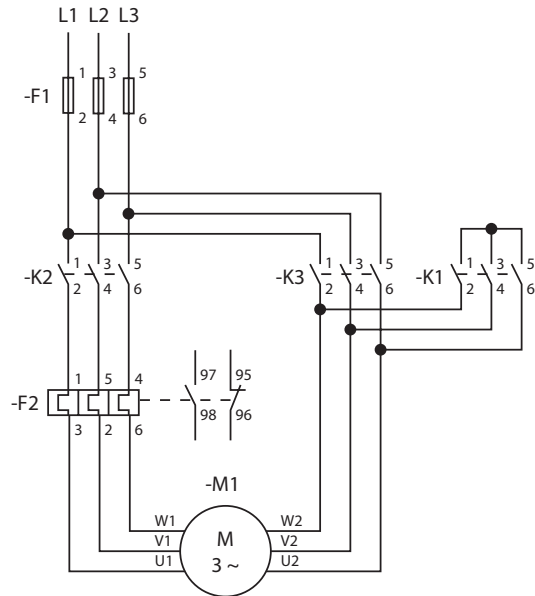

Power circuit diagram

CT-S range

Technical diagrams

Connection diagrams

CT-MVS.21

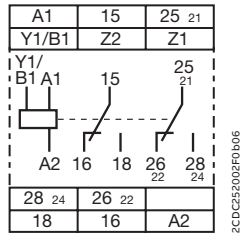

A1-A2 Supply: 24-240 V AC/DC

A1-Y1/B1 Control input

15-16/18 1st c/o contact

25-26/28 2nd c/o contact

21-22/24 2nd c/o contact as instantaneous contact

Z1-Z2 Remote potentiometer connection

CT-MVS.22

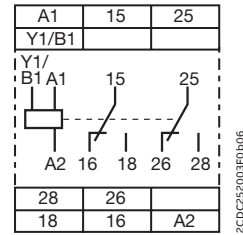

A1-A2 Supply: 224-48 V DC or 24-240 V AC

A1-Y1/B1 Control input

15-16/18 1st c/o contact

25-26/28 2nd c/o contact

CT-MVS.23

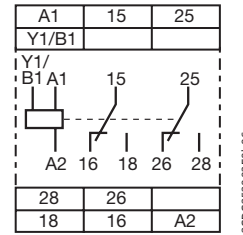

A1-A2 Supply: 380-440V AC

A1-Y1/B1 Control input

15-16/18 1st c/o contact

25-26/28 2nd c/o contact

CT-MVS.12

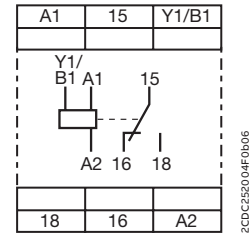

A1-A2 Supply: 24-48 V DC or 24-240 V AC

A1-Y1/B1 Control input

15-16/18 1st c/o contact

CT-MXS.22

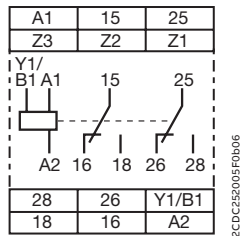

A1-A2 Supply: 24-48 V DC or 24-240 V AC

A1-Y1/B1 Control input

15-16/18 1st c/o contact

25-26/28 2nd c/o contact

Z1-Z2 Remote potentiometer connection

Z3-Z2 Remote potentiometer connection

CT-MFS.21

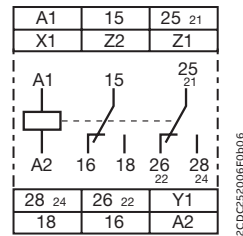

A1-A2 Supply: 24-240 V AC/DC

15-16/18 1st c/o contact

25-26/28 2nd c/o contact

21-22/24 2nd c/o contact as instantaneous contact

Y1-Z2 Control input

X1-Z2 Control input

Z1-Z2 Remote potentiometer connection

CT-MBS.22

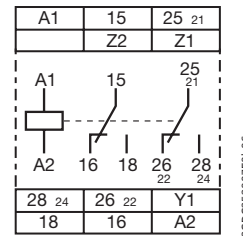

A1-A2 Supply: 24-48 V DC or 24-240 V AC

15-16/18 1st c/o contact

25-26/28 2nd c/o contact

21-22/24 2nd c/o contact as instantaneous contact

Y1-Z2 Control input

Z1-Z2 Remote potentiometer connection

CT-WBS.22

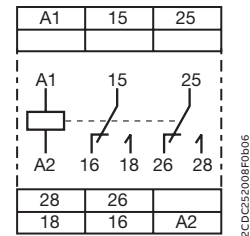

A1-A2 Supply: 24-48 V DC or 24-240 V AC

15-16/18 1st c/o contact

25-26/28 2nd c/o contact

CT-S range

Technical diagrams

Connection diagrams

☒ CT-ERS.21

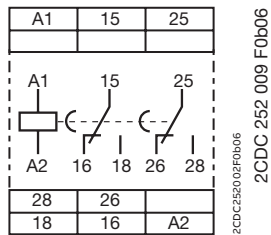

A1-A2 Supply: 24-240 V AC/DC

15-16/18 1st c/o contact
25-26/28 2nd c/o contact

☒ CT-ERS.22

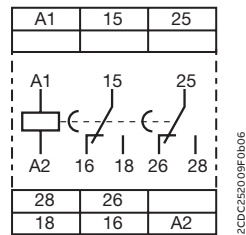

A1-A2 Supply: 24-48 V DC or 24-240 V AC

15-16/18 1st c/o contact
25-26/28 2nd c/o contact

☒ CT-ERS.12

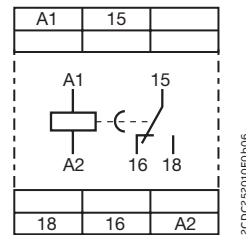

A1-A2 Supply: 24-48 V DC or 24-240 V AC

15-16/18 1st c/o contact

■ CT-APS.21

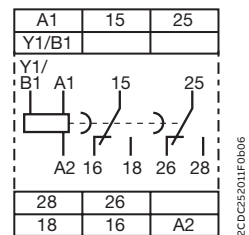

A1-A2 Supply: 24-240 V AC/DC

A1-Y1/B1 Control input
15-16/18 1st c/o contact
25-26/28 2nd c/o contact

■ CT-APS.22

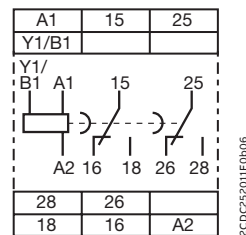

A1-A2 Supply: 24-48 V DC or 24-240 V AC

A1-Y1/B1 Control input
15-16/18 1st c/o contact
25-26/28 2nd c/o contact

■ CT-APS.12

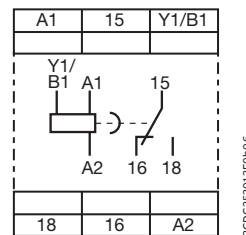

A1-A2 Supply: 24-48 V DC or 24-240 V AC

A1-Y1/B1 Control input
15-16/18 1st c/o contact

■ CT-AHS.22

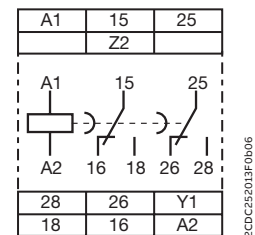

A1-A2 Supply: 24-48 V DC or 24-240 V AC

Y1-Z2 Control input
15-16/18 1st c/o contact
25-26/28 2nd c/o contact

■ CT-ARS.11

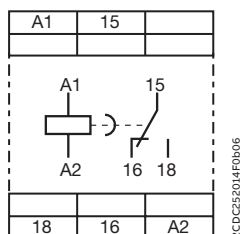

A1-A2 Supply: 24-240 V AC/DC

15-16/18 1st c/o contact

■ CT-ARS.21

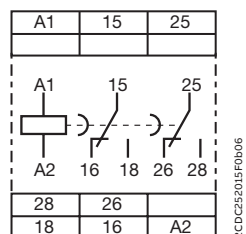

A1-A2 Supply: 24-240 V AC/DC

15-16/18 1st c/o contact
25-26/28 2nd c/o contact

△ CT-SDS.22

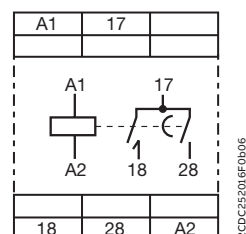

A1-A2 Supply: 24-48 V DC or 24-240 V AC

17-18 1st n/o contact
17-28 2nd n/o contact

△ CT-SDS.23

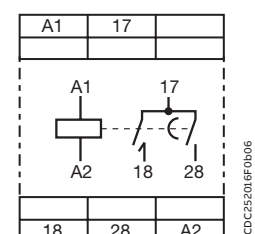

A1-A2 Supply: 380-440 V AC

17-18 1st n/o contact
17-28 2nd n/o contact

CT-S range

Technical diagrams

Load limit curves

AC load (resistive)

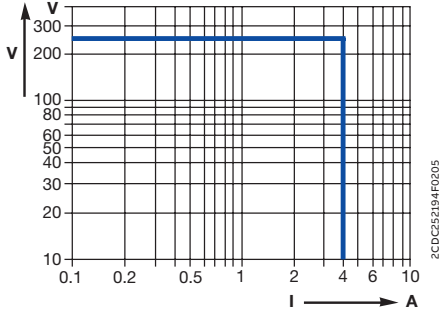

DC load (resistive)

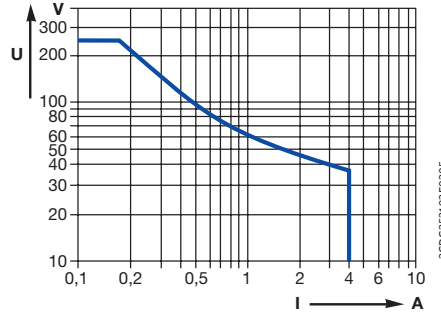

Derating factor F for inductive AC load

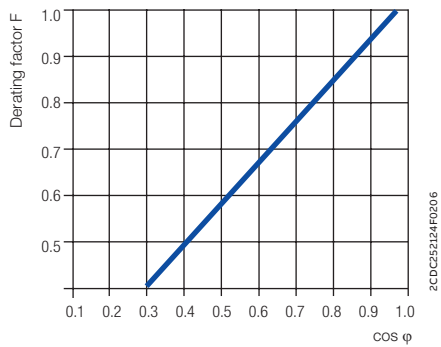

Contact lifetime

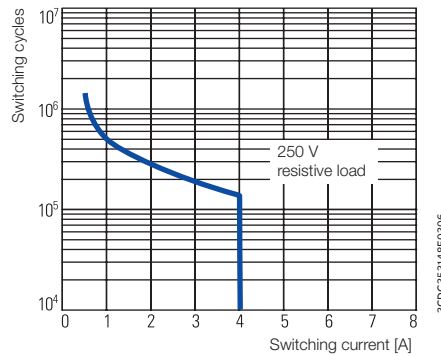

Wiring notes

Control inputs (volt-free triggering)

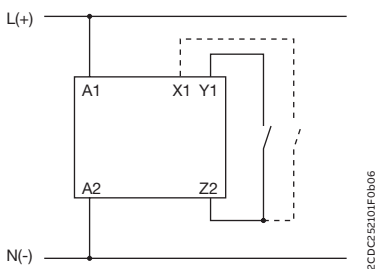

Triggering of the control inputs (volt-free) with a proximity switch (3 wire)

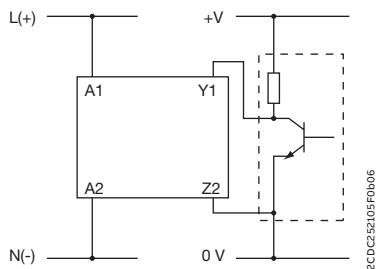

CT-S range

Technical diagrams

Wiring notes

Control inputs (voltage-related triggering)

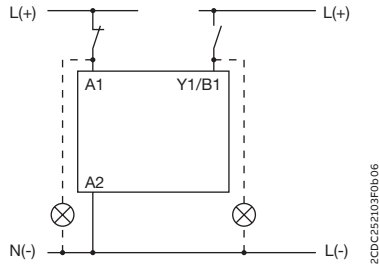
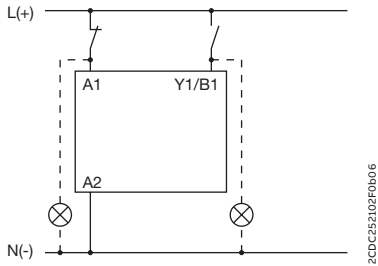

Remote potentiometer

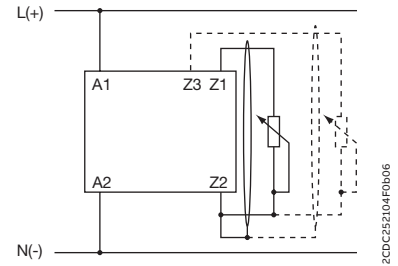

The control input Y1/B1 is triggered with electric potential against A2. It is possible to use the control supply voltage from terminal A1 or any other voltage within the rated control supply voltage range.

Dimensional drawings

Main device

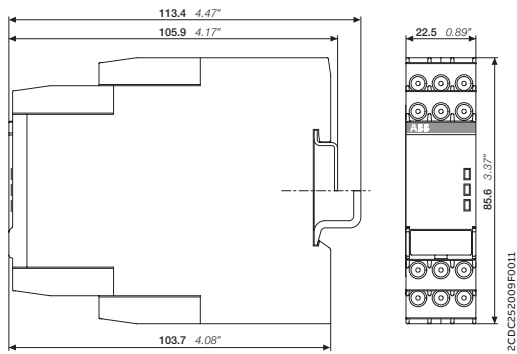

ADP.01 adapter for screw mounting

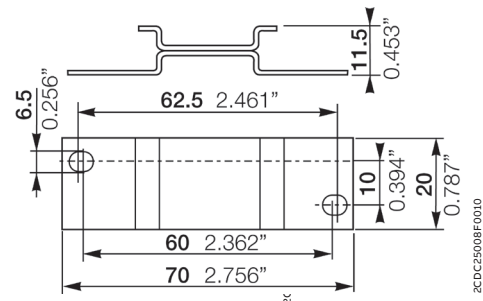

COV.11 sealable transparent cover

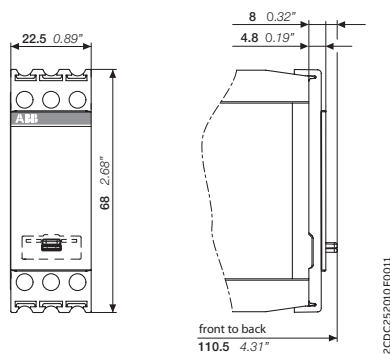

MAR.01 marker label

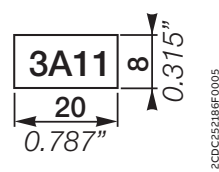

Dimensions in mm, inches



Time relays for building applications

Table of contents

43	Applications
44	Benefits and advantages
46	Selection table
47	Ordering details
48	Technical data
51	Technical diagrams

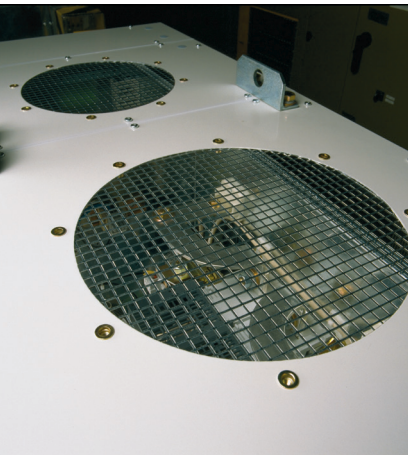

Time relays for building applications

Applications

The CT-D range is designed in a modular housing, making it well suited for building and residential applications. In just 12 order codes the CT-D range covers all the main timing functions needed for building automation, safely and reliably.



A typical application for timers is delayed switching. Switching several rows of lamps on and off in corridors, stairwells, staircases, etc, is a widespread application in which the excellent functionality of the CT-D timers is undisputed.



Air conditioning systems, heaters and fans can be found everywhere in buildings - just like the CT-D timers long used to switch them. On-delay, off-delay and a range of other functions cover all requirements.



Elevators, escalators, gates, compressors and doors - here too ABB timers ensure optimum and time-delayed opening as required. ABB's CT-D timers cover most functions with just 12 order codes.

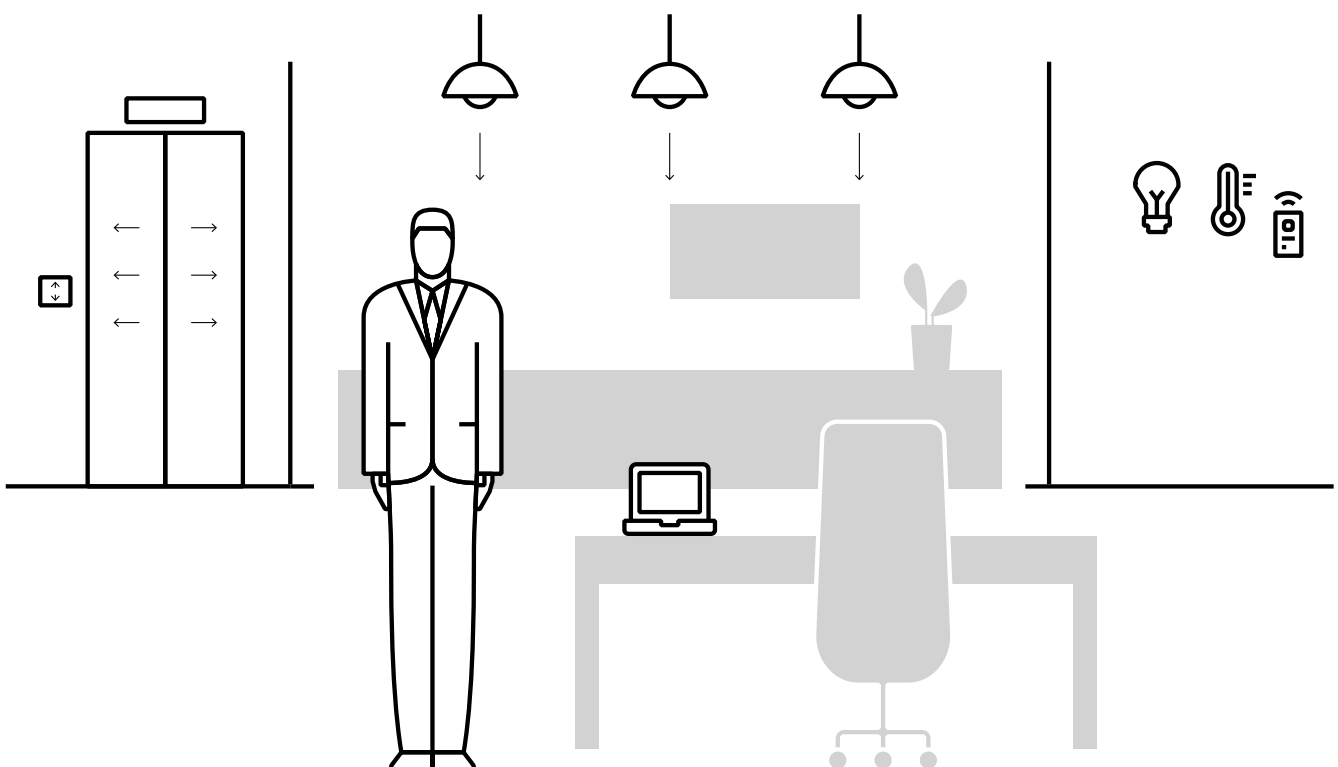

CT-D range

Benefits and advantages



The CT-D range is ideal for building applications and installation panels, due to its compact modular housing. For maximum flexibility in operation, nine single-function as well as two multifunction devices with seven timing functions are available. The devices offer four or seven time ranges from 0.05 seconds up to 100 hours. Their wide supply voltage range allows their use in applications worldwide.

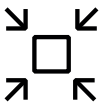

Space savings

The CT-D range is ideal for installation panels thanks to its compact modular housing. The housing's design helps make the status and configuration more clearly visible. The CT-D range also offers a higher output current than standard industrial types. As well as the 1 c/o contacts, ABB offers devices with 2 c/o contacts for maximum flexibility.



Easy to install

Direct reading scales help make time setting quick and easy. A pre-selection for the time range together with an additional scale for fine adjustments help improve installation efficiency. For more flexibility, the delay time can even be changed when processes are running, making optimization to fit the application even simpler. All devices can be mounted and demounted tool-free.



Global availability

The CT-D range fulfills various global standards and approvals, supporting business worldwide. Additionally, all devices from the CT-D range have a wide supply voltage from 24-48 V DC and 24-240 V AC, making it ideal for the use in installation panels around the world.

CT-D range

Operating controls



Connection terminals

Wide terminal spacing makes connection of wires simpler: 2 x 1.5 mm² (2 x 16 AWG) with wire end ferrules or 2 x 2.5 mm² (2 x 14 AWG) without ferrules.



Preselection of the time range



Direct reading scales

Direct setting of the time delay without any additional calculation provides accurate time delay adjustment.



Selection of the timing function

- ON-delay
- OFF-delay with aux. voltage
- Impulse-ON
- Impulse-OFF with aux. voltage
- Flasher starting with ON
- Flasher starting with OFF
- Pulse former

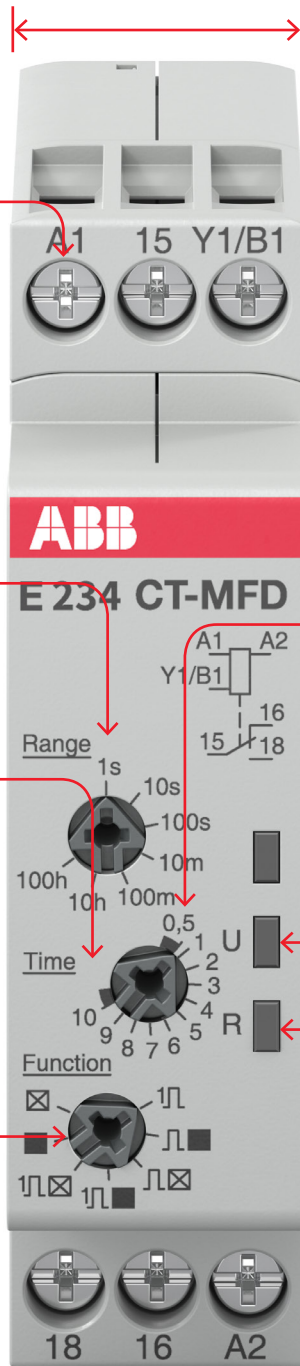

Width 17.5 mm

With a width of just 17.5 mm, the CT-D range timers are ideally suited for installation in distribution panels.



Fine adjustment of the time delay



LEDs for status indication

All actual operational states are displayed by front-facing LEDs, thus simplifying commissioning and troubleshooting.

- U - green LED:
 - control supply voltage applied /
 - timing
- R, R1, R2 - yellow LED:
 - output relay energized

CT-D range

Ordering details



2CDC251002V0018

CT-MFD.12



2CDC251002V0018

CT-ERD.22

- Control input with voltage-related triggering
- No triggering

Description

The CT-D range with its modular design is a perfect solution for installation panels. For maximum flexibility in operation, 10 single-function as well as two multifunction devices with seven timing functions are available. The devices offer four or seven time ranges from 0.05 seconds up to 100 hours. Their wide input range allows their use in applications worldwide.

Ordering details

Timing function	Rated control supply voltage	Time ranges	Control input	Output	Type	Order code	Weight (1 pc)
							kg (lb)
Multi ¹⁾	24-240 V AC 24-48 V DC	7 (0.05 s - 100 h)	■	1 c/o	CT-MFD.12	1SVR500020R0000	0.060 (0.132)
Multi ¹⁾	12-240 V AC/DC	7 (0.05 s - 100 h)	■	2 c/o	CT-MFD.21	1SVR500020R1100	0.065 (0.143)
ON-delay	24-240 V AC 24-48 V DC	7 (0.05 s - 100 h)	-	1 c/o	CT-ERD.12	1SVR500100R0000	0.060 (0.132)
			-	2 c/o	CT-ERD.22	1SVR500100R0100	0.065 (0.143)
OFF-delay			■	1 c/o	CT-AHD.12	1SVR500110R0000	0.060 (0.132)
			■	2 c/o	CT-AHD.22	1SVR500110R0100	0.065 (0.143)
Impulse-ON			-	1 c/o	CT-VWD.12	1SVR500130R0000	0.060 (0.132)
Flasher starting with ON					CT-EBD.12	1SVR500150R0000	
Pulse generator		2×7 (0.05 s - 100 h)	■		CT-TGD.12 ²⁾	1SVR500160R0000	0.060 (0.132)
			■	2 c/o	CT-TGD.22 ²⁾	1SVR500160R0100	0.065 (0.143)
Star-delta change-over		4 (0.05 s - 10 min)	-	2 n/o	CT-SDD.22 ³⁾	1SVR500211R0100	0.065 (0.143)
			-		CT-SAD.22 ⁴⁾	1SVR500210R0100	

¹⁾ Functions: ON-delay, OFF-delay with auxiliary voltage, Impulse-ON, Impulse-OFF with auxiliary voltage, Flasher starting with ON, Flasher starting with OFF, Pulse former

²⁾ ON and OFF times adjustable independently: 2 x 7 time ranges 0.05 s - 100 h



³⁾ Transition time 50 ms fixed

⁴⁾ Transition time adjustable

CT-D range

Technical data

Data at $T_a = 25\text{ °C}$ and rated values, unless otherwise indicated

	CT-D with 1 c/o contact	CT-D with 2 c/o contacts	CT-MFD.21
Input circuit - Supply circuit			
Rated control supply voltage U_s	24-240 V AC / 24-48 V DC		12-240 V AC/DC
Rated control supply voltage U_s tolerance	-15...+10 %		
Rated frequency	DC or 50/60 Hz		
Frequency range AC	47-63 Hz		
Typical power consumption	max. 3.5 VA		
Power failure buffering time	min. 20 ms		
Release voltage	> 10 % of the minimum rated control supply voltage U_s		
Input circuit - Control circuit			
Control input, control function	A1-Y1/B1	start timing external	
Kind of triggering	voltage-related triggering		
Resistance to reverse polarity	yes		
Parallel load / polarized	yes / yes		
Maximum cable length to the control inputs	50 m - 100 pF/m		
Minimum control pulse length	20 ms		
Control voltage potential	see rated control supply voltage		
Current consumption of the control input	see data sheet		
Timing circuit			
Time ranges	7 time ranges 0.05 s - 100 h	1.) 0.05-1 s 2.) 0.5-10 s 3.) 5-100 s 4.) 0.5-10 min 5.) 5-100 min 6.) 0.5-10 h 7.) 5-100 h	
	4 time ranges 0.05 s - 10 min (CT-SDD, CT-SAD)	1.) 0.05-1 s 2.) 0.5-10 s 3.) 5-100 s 4.) 0.5-10 min	
Recovery time	< 50 ms		
Accuracy within the rated control supply voltage tolerance	$\Delta t < 0.005\% / V$		
Accuracy within the temperature range	$\Delta t < 0.06\% / \text{°C}$		
Repeat accuracy (constant parameters)	$\Delta t < \pm 0.5\%$		
Setting accuracy of time delay	$\pm 10\%$ of full-scale value		
Star-delta transition time	CT-SDD/ CT-SAD	fixed 50 ms / adjustable: 20 ms, 30 ms, 40 ms, 50 ms, 60 ms, 80 ms or 100 ms	
Star-delta transition time tolerance	CT-SDD / CT-SAD	$\pm 3\text{ ms}$	
Indication of operational states			
Control supply voltage / timing	U: green LED	 : control supply voltage applied  : timing	
Relay energized	R, R1, R2: yellow LED	 : output relay energized	
Operating elements and controls			
Adjustment of the time range	front-face rotary switch, direct reading scales		
Fine adjustment of the time value	front-face potentiometer		
Preselection of the timing function at multifunction devices	front-face rotary switch, direct reading scales		
Adjustment of the transition time	CT-SAC	front-face potentiometer	

CT-D range

Technical data

		CT-D with 1 c/o contact	CT-D with 2 c/o contacts	CT-MFD.21
Output circuit				
Kind of output	15-16/18	Relay, 1 c/o contact	-	
	15-16/18; 25-26/28	-	Relay, 2 c/o contacts	
	17-18; 17-28		Relay, 2 n/o contacts (CT-SDC, CT-SAC)	
Contact material		AgNi alloy, Cd free		
Rated operational voltage U_e		250 V		
Minimum switching voltage / minimum switching current		12 V / 100 mA		
Maximum switching voltage / maximum switching current		250 V AC / 6 A	250 V AC / 5 A	
Rated operational current I_e	AC-12 (resistive) at 230 V	6 A	5 A	
	AC-15 (inductive) at 230 V	3 A	3 A	n/o: 3 A n/c: 0.75 A
	DC-12 (resistive) at 24 V	6 A	5 A	
	DC-13 (inductive) at 24 V	2 A	2 A	1 A
AC rating (UL 508)	utilization category (Control Circuit Rating Code)	B 300		n/o: B 300 n/c: C 300
	max. rated operational voltage	300 V AC		
	maximum continuous thermal current at B300	5 A		n/o: 5 A
	maximum continuous thermal current at C300	-		n/c: 2.5 A
	max. making/breaking apparent power at B300	3600 VA / 360 VA		n/o: 3600/360 VA
	max. making/breaking apparent power at C300	-		n/c: 1800/180 VA
Mechanical lifetime		30 x 10 ⁶ switching cycles		
Electrical lifetime		0.1 x 10 ⁶ switching cycles		
Max. fuse rating to achieve short-circuit protection	n/c contact	6 A fast-acting		
	n/o contact	10 A fast-acting		6 A fast-acting
General data				
Mean time between failures (MTBF)		on request		
Duty time		100%		
Dimensions		see 'Dimensional drawings'		
Mounting		DIN rail (IEC/EN 60715), snap-mounting without any tool		
Mounting position		any		
Minimum distance to other units	horizontal / vertical	no / no		
Degree of protection	housing / terminals	IP50 / IP20		
Electrical connection				
Connecting capacity	fine-stranded with(out) wire and ferrule	2 x 0.5-1.5 mm ² (2 x 20-16 AWG) 1 x 0.5-2.5 mm ² (1 x 20-14 AWG)		
	rigid	2 x 0.5-1.5 mm ² (2 x 20-16 AWG) 1 x 0.5-4 mm ² (1 x 20-12 AWG)		
Stripping length		7 mm (0.28 in)		
Tightening torque		0.5-0.8 Nm (4.43-7.08 lb.in)		
Environmental data				
Ambient temperature range	operation / storage	-20 ... +60 °C / -40 ... +85 °C		
Climatic class	EC/EN 60068-2-30	3K3		
Relative humidity range		25-85%		
Vibration, sinusoidal	IEC/EN 60068-2-6	20 m/s ² ; 10 cycles, 10...150...10 Hz		
Shock (half-sine)	IEC/EN 60068-2-27	150 m/s ² , 11 ms		

CT-D range

Technical data

		CT-D with 1 c/o contact	CT-D with 2 c/o contacts	CT-MFC.21
Isolation data				
Rated insulation voltage U_i	input circuit / output circuit	300 V		
	output circuit 1 / output circuit 2	not available	300 V	300 V
Rated impulse withstand voltage U_{imp}	between all isolated circuits	4 kV; 1.2/50 μ s		
Power-frequency withstand voltage test(test voltage)	between all isolated circuits	2.5 kV; 50 Hz; 60 s		
Basic insulation (IEC/EN 61140)	input circuit / output circuit	300 V		
Protective separation (IEC/EN 61140, EN 50178)	input circuit / output circuit	250 V		
Pollution degree		3		
Overvoltage category		III		
Standards / Directives				
Standards		IEC/EN 61812-1		
Low Voltage Directive		2014/35/EU		
EMC Directive		2014/30/EU		
RoHS Directive		2011/65/EU		
Electromagnetic compatibility				
Interference immunity to		IEC/EN 61000-6-2		
electrostatic discharge	IEC/EN 61000-4-2	Level 3 (6 kV / 8 kV)		
radiated, radio-frequency, electromagnetic field	IEC/EN 61000-4-3	Level 3 (10 V / m)		
electrical fast transient / burst	IEC/EN 61000-4-4	Level 3 (2 kV / 5 kHz)		
surge	IEC/EN 61000-4-5	Level 4 (2 kV L-L)		
conducted disturbances, induced by radio-frequency fields	IEC/EN 61000-4-6	Level 3 (10 V)		
Interference emission		IEC/EN 61000-6-3		
high-frequency radiated	IEC/CISPR 22, EN 55022	Class B		
high-frequency conducted	IEC/CISPR 22, EN 55022	Class B		

CT-D range

Technical diagrams

Example of application - Star-delta changeover

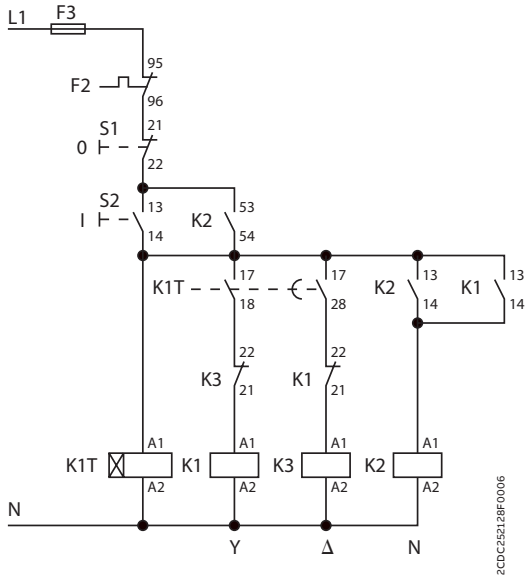

2CDC252128F0006

Control circuit diagram

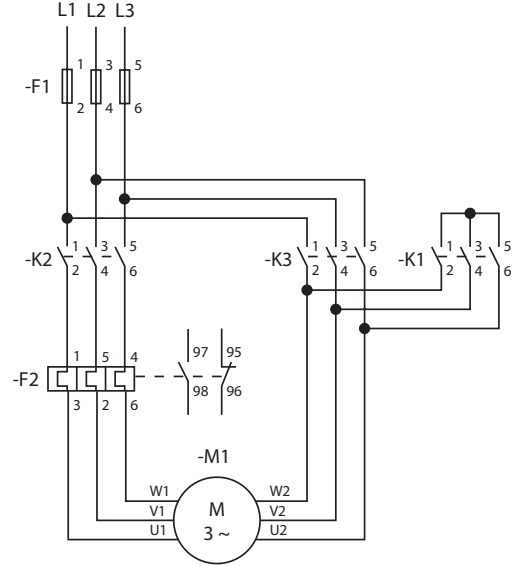

2CDC253009F0012

Power circuit diagram

CT-D range

Technical diagrams

Connection diagrams

CT-MFD.21

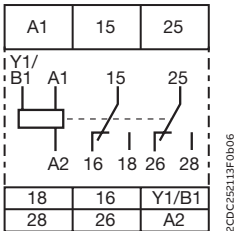

A1-A2	Supply: 12-240 V AC/DC
A1-Y1/B1	Control input
15-16/18	1st c/o contact
25-26/28	2nd c/o contact

CT-MFD.12

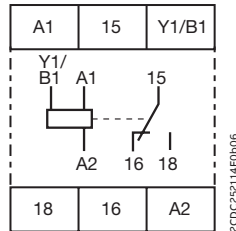

A1-A2	Supply: 24-48 V DC or 24-240 V AC
A1-Y1/B1	Control input
15-16/18	1st c/o contact

CT-ERD.22

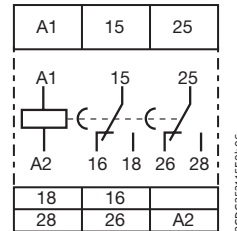

A1-A2	Supply: 24-48 V DC or 24-240 V AC
15-16/18	1st c/o contact
25-26/28	2nd c/o contact

CT-ERD.12

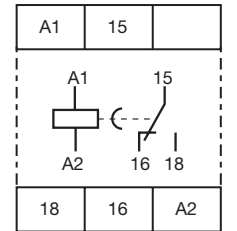

A1-A2	Supply: 24-48 V DC or 24-240 V AC
15-16/18	1st c/o contact

CT-AHD.22

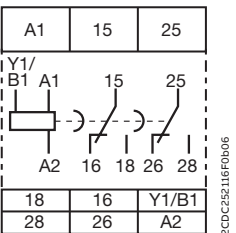

A1-A2	Supply: 24-48 V DC or 24- 240 V AC
A1-Y1/B1	Control input
15-16/18	1st c/o contact
25-26/28	2nd c/o contact

CT-AHD.12

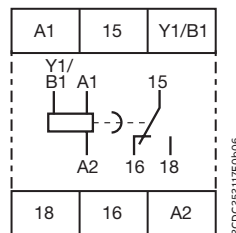

A1-A2	Supply: 24-48 V DC or 24- 240 V AC
A1-Y1/B1	Control input
15-16/18	1st c/o contact

CT-VWD.12

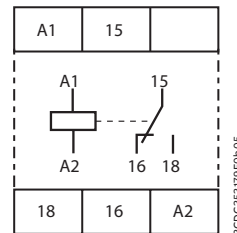

A1-A2	Supply: 24-48 V DC or 24- 240 V AC
15-16/18	1st c/o contact

CT-TGD.22

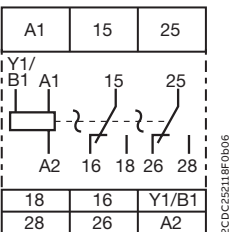

A1-A2	Supply: 24-48 V DC or 24-240 V AC
A1-Y1/B1	Control input
15-16/18	1st c/o contact
25-26/28	2nd c/o contact

CT-TGD.12

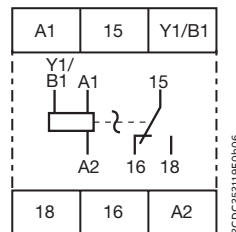

A1-A2	Supply: 24-48 V DC or 24- 240 V AC
A1-Y1/B1	Control input
15-16/18	1st c/o contact

CT-SDD.22

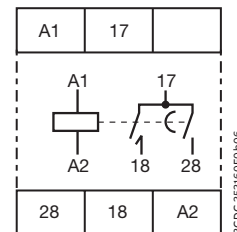

A1-A2	Supply: 24-48 V DC or 24-240 V AC
17-18	1st n/o contact (star contactor)
17-28	2nd n/o contact (delta contactor)

CT-SAD.22

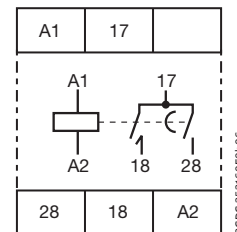

A1-A2	Supply: 24-48 V DC or 24-240 V AC
17-18	1st n/o contact (star contactor)
17-28	2nd n/o contact (delta contactor)

CT-D range

Technical diagrams

Load limit curves

AC load (resistive)

CT-D.1x

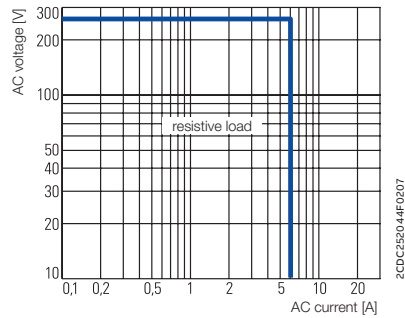

DC load (resistive)

CT-D.1x

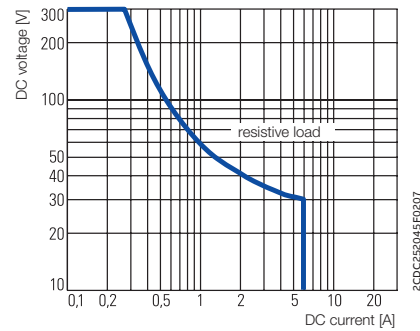

Derating factor F for inductive AC load

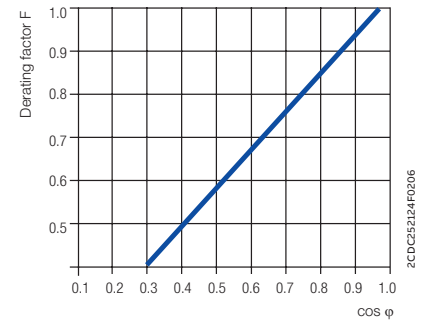

CT-D.2x

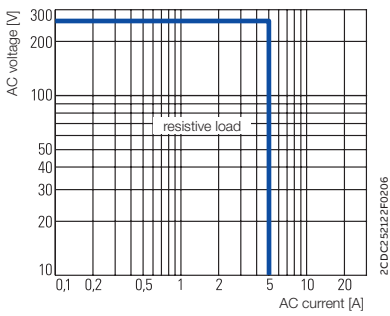

CT-D.2x

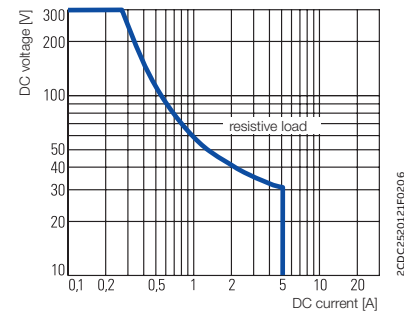

Contact lifetime

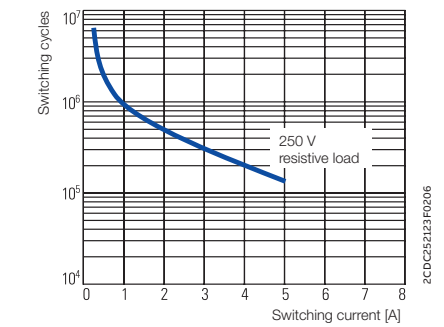

Wiring notes for devices with control input

A parallel load to the control input is possible

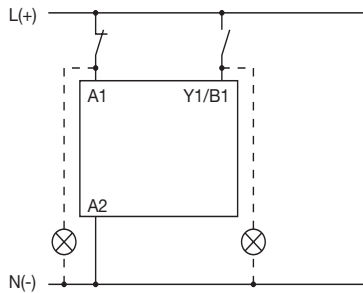

Dimensional drawings

CT-D devices with 1 c/o contact or 2 n/o contacts

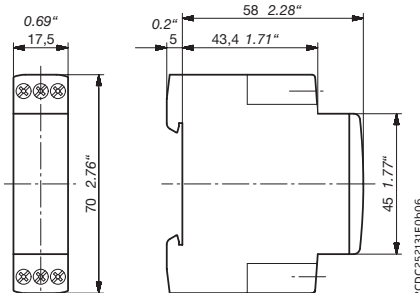

CT-D devices with 2 c/o contacts

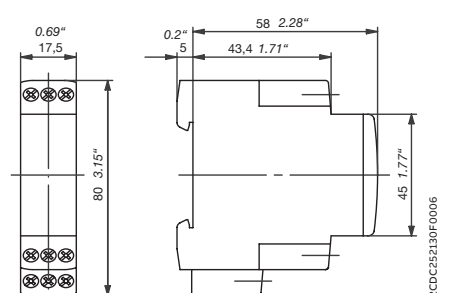

Dimensions in mm, inches





Timing functions

Timing functions

CT-C, CT-S, CT-D

On delay functions (Delay on make) ☒

On-delay



This function requires a continuous control supply voltage for timing. Timing begins when a control supply voltage is applied. When the selected time delay is complete, the output relay energizes. If the control supply voltage is interrupted, the output relay de-energizes and the time delay is reset.

ON-delay accumulative



This function requires a continuous control supply voltage for timing. Timing begins when a control supply voltage is applied. When the selected time delay is complete, the output relay energizes. Timing can be paused by closing the control input.

The elapsed time t_1 is stored and continues from this time value when the control input is re-opened. If the control supply voltage is interrupted, the output relay de-energizes and the time delay is reset.

OFF delay functions (Delay on break) ■

OFF-delay with auxiliary voltage

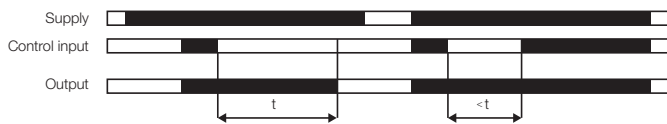

This function requires a continuous control supply voltage for timing. If the control input is closed, the output relay energizes immediately. If the control input is opened, the time delay starts. When the selected time delay is complete, the output relay de-energizes.

If control input re-closes before the time delay is complete, the time delay is reset and the output relay does not change state. Timing starts again when the control input re-opens. If the control supply voltage is interrupted, the output relay de-energizes and the time delay is reset.

OFF-delay without auxiliary voltage



The OFF-delay function without auxiliary voltage does not require a continuous control supply voltage for timing. Applying a control supply voltage energizes the output relay. If the control supply voltage is interrupted, the OFF-delay starts. When timing is complete, the output relay de-energizes.

If a control supply voltage is re-applied before the time delay is complete, the time delay is reset and the output relay remains energized. A control supply voltage must be applied for the minimum energizing time (200 ms), for correct operation.

Timing functions

CT-C, CT-S, CT-D

OFF-delay with auxiliary voltage (Delay on break), accumulative

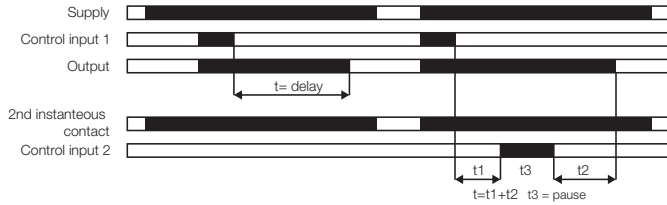

This function requires a continuous control supply voltage for timing. If the control input is closed, the output relay energizes immediately. If the control input is opened, the time delay starts. When the selected time delay is complete, the output relay de-energizes. If the control input closes before the time delay is complete, the time delay is reset and the output relay does not change state. Timing starts again when the control input reopens.

Pause timing / Accumulative OFF-delay: Timing can be paused by closing control 1. The elapsed time t_1 is stored and continues from this time value when control input 1 is re-opened. This can be repeated as often as required. If the control supply voltage is interrupted, the output relay de-energizes and the time delay is reset.

Impulse-ON functions $1 \square \square \square$

Impulse-ON (interval)



This function requires a continuous control supply voltage for timing. The output relay energizes immediately when the control supply voltage is applied and de-energizes after the set pulse time is complete. If the control supply voltage is interrupted, the output relay de-energizes and the time delay is reset.

Impulse-ON, accumulative



This function requires a continuous control supply voltage for timing. The output relay energizes immediately when the control supply voltage is applied and de-energizes after the set pulse time is complete. If control input 1 is open, timing begins when a control supply voltage is applied. Or, if control a supply voltage is already applied, opening control input 1 starts timing. When the selected pulse time is complete, the output relay de-energizes. Closing control input 1, before the pulse time is complete, de-energizes the output relay and resets the pulse time.

Pause timing / Accumulative impulse-ON: Timing can be paused by closing control input 2. The elapsed time t_1 is stored and continues from this time value when control input 2 is re-opened. This can be repeated as often as required. If the control supply voltage is interrupted, the output relay de-energizes and the time delay is reset.

Timing functions

CT-C, CT-S, CT-D

Impulse-OFF functions 1

Impulse-OFF with auxiliary voltage

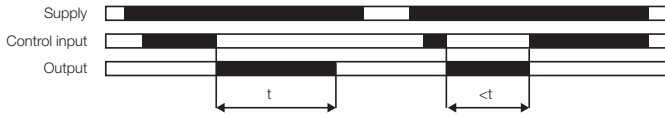

This function requires a continuous control supply voltage for timing. The output relay energizes immediately when the control input is de-energized and the output de-energizes after the set pulse time is complete. If the control supply voltage is interrupted, the output relay de-energizes and the time delay is reset.

Impulse-OFF without auxiliary voltage

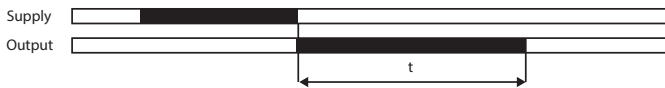

This function does not require a continuous control supply voltage for timing. If the control supply voltage is interrupted, the output relay energizes and the OFF time starts. When timing is complete, the output relay de-energizes. If a control supply voltage is re-applied before the time delay is complete, the time delay is reset and the output relay de-energizes. A control supply voltage must be applied for the minimum energizing time (200 ms), for proper operation.

Impulse-OFF with auxiliary voltage (Trailing edge interval)

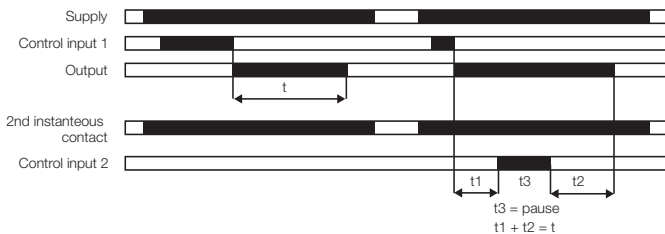

This function requires a continuous control supply voltage for timing. If a control supply voltage is applied, opening control input 1 energizes the output relay immediately and starts timing. When the selected pulse time is complete, the output relay de-energizes. Closing control input 1, before the pulse time is complete, de-energizes the output relay and resets the pulse time. Pause timing / Accumulative impulse-OFF: Timing can be paused by closing control input 2. The elapsed time t1 is stored and continues from this time value when control input 2 is re-opened. This can be repeated as often as required. If the control supply voltage is interrupted, the output relay de-energizes and the time delay is reset.

Impulse-ON and Impulse-OFF functions 1

Impulse-ON and impulse-OFF

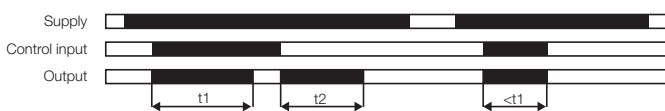

This function requires a continuous control supply voltage for timing. If a control supply voltage is applied, closing the control input energizes the output relay immediately and starts the pulse time t1. When t1 is complete, the output relay de-energizes. Re-opening the control input energizes the output relay immediately and starts the pulse time t2. When t2 is complete, the output relay de-energizes. t1 and t2 are independently adjustable. If the control input changes state before the pulse time is complete, the output relay de-energizes and the pulse time is reset. If the control input changes state again, the interrupted pulse time restarts. If the control supply voltage is interrupted, the output relay de-energizes and the time delay is reset.

Timing functions

CT-C, CT-S, CT-D

Flasher starting with ON functions

Flasher starting with ON



Applying a control supply voltage starts timing with symmetrical ON & OFF times. The cycle starts with an ON time first. If the control supply voltage is interrupted, the output relay de-energizes and the time delay is reset.

Flasher with reset starting with ON

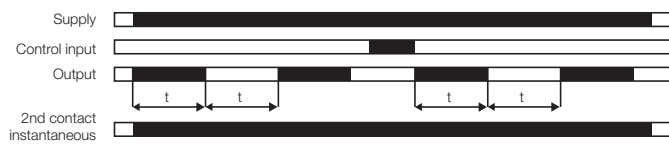

Applying a control supply voltage starts timing with symmetrical ON & OFF times. The cycle starts with an ON time first. The time delay can be reset by closing the control input. Opening the control input starts the timer pulsing again with symmetrical ON & OFF times. If the control supply voltage is interrupted, the output relay de-energizes and the time delay is reset.

Flasher starting with OFF functions

Flasher starting with OFF



Applying a control supply voltage starts timing with symmetrical ON & OFF times. The cycle starts with an OFF time first. If the control supply voltage is interrupted, the output relay de-energizes and the time delay is reset.

Flasher with reset starting with OFF

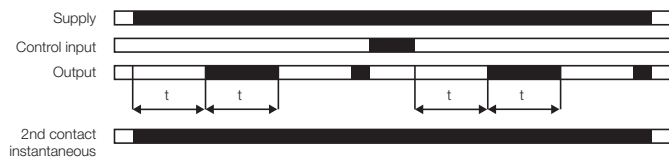

Applying a control supply voltage starts timing with symmetrical ON & OFF times. The cycle starts with an OFF time first. The time delay can be reset by closing the control input. Opening the control input starts the timer pulsing again with symmetrical ON & OFF times. If the control supply voltage is interrupted, the output relay de-energizes and the time delay is reset.

Flasher starting with ON or OFF functions

Flasher starting with ON or OFF

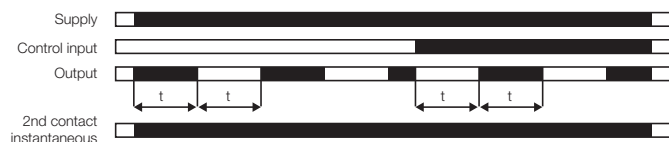

Applying a control supply voltage starts timing with symmetrical ON / OFF times. If the control input is open while supply voltage is connected the cycle starts with an ON time first. If the control input is closed while supply voltage is connected the cycle starts with an OFF time first.

Timing functions

CT-C, CT-S, CT-D

Pulse former

Puls former (single shot)



This function requires a continuous control supply voltage for timing. Closing the control input energizes the output relay immediately and starts timing. Operating the control input during the time delay has no effect. When the selected ON time is complete, the output relay de-energizes. After the ON time is complete, it can be restarted by closing the control input. If control supply voltage is interrupted, the output relay de-energizes and the time delay is reset.

Single-pulse former

Single-pulse generator, starting with OFF



This function requires a continuous control supply voltage for timing. Applying a control supply voltage while the control input is open energizes the output relay after the OFF time t_1 is complete. When the following ON time t_2 is complete, the output relay de-energizes. Alternatively, when a control supply voltage is already applied, the timing process can be started by opening control input. Closing the control input with a control supply voltage applied, de-energizes the output relay and re-sets the time delay. The ON & OFF times are independently adjustable.

Pulse generator

Starting with the ON or OFF time
(Recycling unequal times, ON or OFF first)

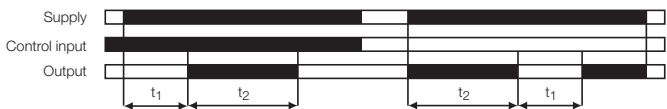

This function requires a continuous control supply voltage for timing. Applying a control supply voltage, with closed control input, starts timing with an OFF time first. Applying a control supply voltage, with open control input, starts timing with an ON time first. If the control supply voltage is interrupted, the output relay de-energizes and the time delay is reset.

Impulse with delay

Fixed impulse with adjustable time delay



This function requires a continuous control supply voltage for timing. The time delay t_1 starts when a control supply voltage is applied. When t_1 is complete, the output relay energizes for the fixed impulse time t_2 of 500 ms. If the control supply voltage is interrupted, the time delay is re-set. The output relay does not change state.

Adjustable impulse with fixed time delay



This function requires a continuous control supply voltage for timing. As soon as the control supply voltage is applied the output relay will close after 500 ms. When t_2 is complete, the output relay energizes and the selected pulse time t_1 starts. When t_1 is complete, the output relay de-energizes. If the control supply voltage is interrupted, the pulse time is reset and the output relay de-energizes.

Timing functions

CT-C, CT-S, CT-D

ON- and OFF-delay

Symmetrical ON- and OFF-delay ¹⁾

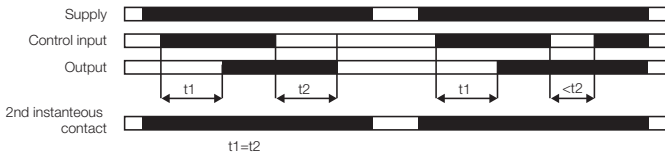

This function requires a continuous control supply voltage for timing. Closing the control input starts the ON-delay time t_1 . When timing is complete, the output relay energizes. Opening the control input starts the OFF-delay time t_2 . When the OFF-delay t_2 is complete, the output relay de-energizes. If the control input opens before the ON-delay ($<t_1$) is complete, the time delay is reset and the output relay remains de-energized. If control input closes before the OFF-delay time ($<t_2$) is complete, the time delay is reset and the output relay remains energized.

1) Variant with 2nd control input for pause timing is available too.

Asymmetrical ON- and OFF-delay

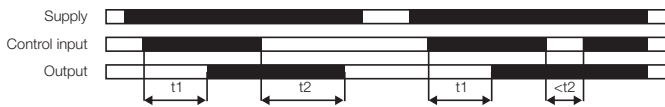

This function requires a continuous control supply voltage for timing. Closing the control input starts the ON-delay t_1 . When timing is complete, the output relay energizes. Opening the control input starts the OFF-delay t_2 . When the OFF-delay is complete, the output relay de-energizes. The ON-delay and OFF-delay are independently adjustable. If the control input opens before the ON-delay is complete ($<t_1$), the time delay is reset and the output relay remains de-energized. If the control input closes before the OFF-delay is complete ($<t_2$), the time delay is reset and the output relay remains energized. If the control supply voltage is interrupted, the output relay de-energizes and the time delay is reset.

Star-Delta Changeover

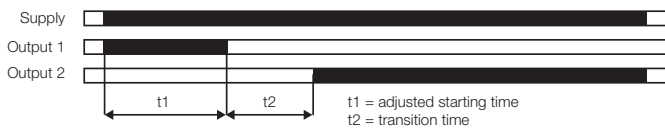

This function requires a continuous control supply voltage for timing. Applying a control supply voltage, energizes the star contactor and begins the set starting time t_1 . When the starting time is complete, the first output contact de-energizes the star contactor. When the transition time t_2 is complete, the second output contact energizes the delta contactor. The delta contactor remains energized as long as the control supply voltage is applied. t_2 is fixed to 50 ms or in some variants adjustable.

Further functions

ON/OFF function



This function is used for test purposes during commissioning and troubleshooting. If the selected maximum value of the time range is smaller than 300 hours (front-face potentiometer "Time sector" \neq 300 h), applying a control supply voltage energizes the output relay immediately. Interrupting the control supply voltage, de-energizes the output relay. If the selected maximum value of the time range is 300 hours (front-face potentiometer "Time sector" = 300 h) and a control supply voltage is applied the output relay does not energize.

ABB STOTZ-KONTAKT GmbH

Eppelheimer Strasse 82
69123 Heidelberg
Germany

**You can find the address of your local
sales organization on the ABB homepage**



abb.com/lowvoltage

We reserve the right to make technical changes or modify the contents of this document without prior notice. With regard to purchase orders, the agreed particulars shall prevail. ABB AG does not accept any responsibility whatsoever for potential errors or possible lack of information in this document.

We reserve all rights in this document and in the subject matter and illustrations contained therein. Any reproduction, disclosure to third parties or utilization of its contents – in whole or in parts – is forbidden without prior written consent of ABB AG Copyright© 2019 ABB AG All rights reserved