

540862 HGDT-35-A Three-point gripper - Series: All

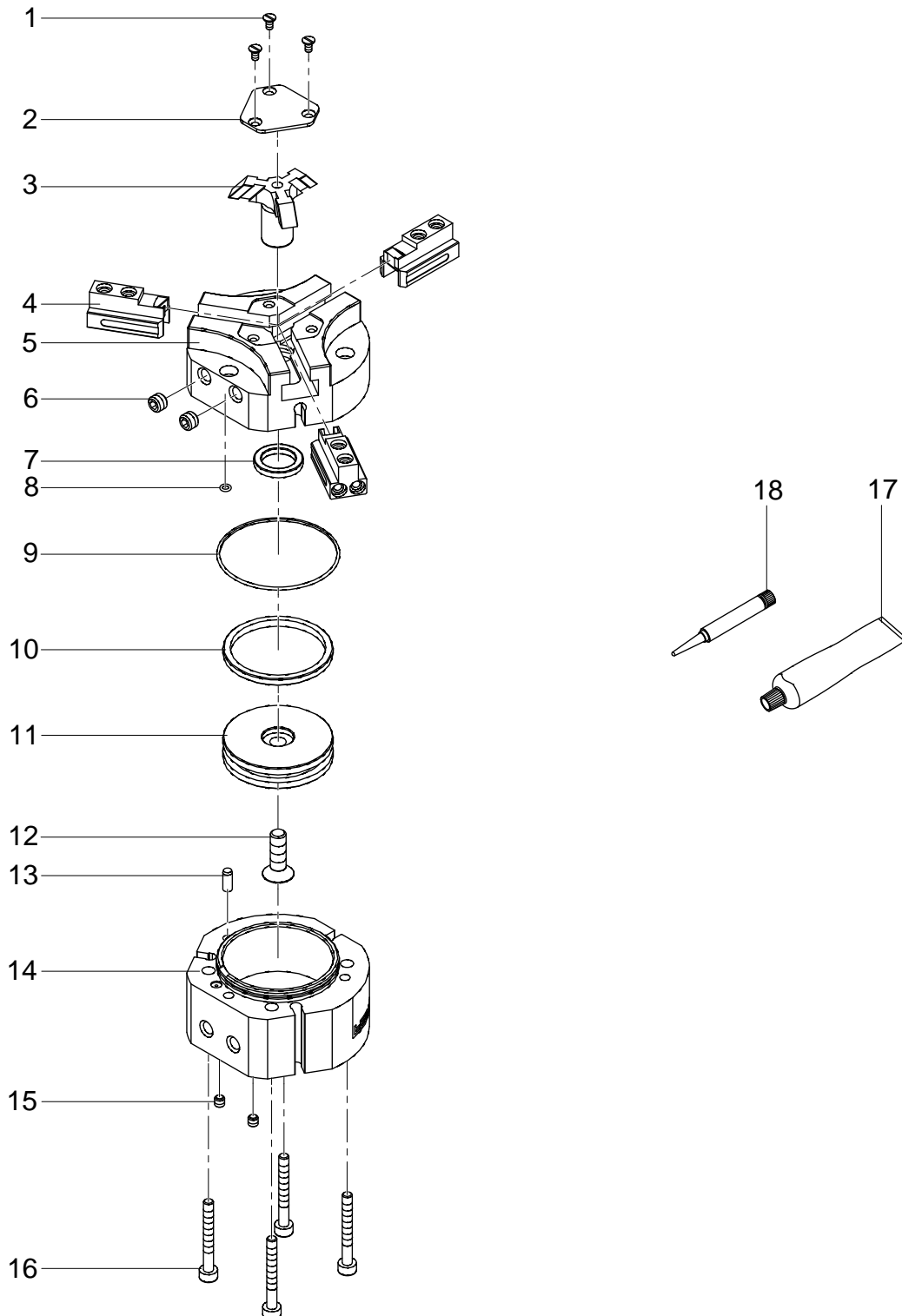

540862 HGDT-35-A Three-point gripper - Series: All

Pos.	Part no.	Type	Note	Qty.	Unit
A	704773	HGDT-35 Set of wearing parts	Spare parts: 7, 8, 9, 10, 12, 17, 18	1	PC
1			Not available	3	PC
2			Not available	1	PC
3			Not available	1	PC
4			Not available	3	PC
5			Not available	1	PC
6			Not available Lubricate with Molykote BR2 during assembly	2	PC
7			Not available separately, see position A Grease using during assembly. See position 17	1	PC
8			Not available separately, see position A Grease using during assembly. See position 17	1	PC
9			Not available separately, see position A Grease using during assembly. See position 17	1	PC
10			Not available separately, see position A Grease using during assembly. See position 17	1	PC
11	706819	HGDT-35-A Piston module	Attention, please order position 999 as well	1	PC
12			Not available separately, see position A Use locking compound. See position 18	1	PC
13			Not available	1	PC
14			Not available	1	PC
15			Not available	2	PC
16			Not available	4	PC
17	665354	LUB-KB1-SILIKONFREI-20ML Lubricating grease	Only for piston chamber!	1	PC
18	8181256	CYBERBOND TM44 TB1ML Adhesive bonding agent		1	PC