



FEATURES

- Linear resistance vs temperature
- Accurate and Interchangeable
- Excellent stability
- Small for fast response
- Wide temperature range
- 3-packaging options

HEL-700 Thin Film Platinum RTDs (Resistance Temperature Detectors) provide excellent linearity, accuracy, stability and interchangeability. Resistance changes linearly with temperature. Laser trimming provides $\pm 0.3^\circ\text{C}$ interchangeability at 25°C .

TYPICAL APPLICATIONS

- HVAC - room, duct and refrigerant equipment
- Electronic assemblies - thermal management, temperature compensation
- Process control - temperature regulation

1000 Ω , 375 alpha provides 10X greater sensitivity and signal-to-noise. Both 1000 Ω and 100 Ω provide interchangeabilities of $\pm 0.6^\circ\text{C}$ or better from -100°C to 100°C , and $\pm 3.0^\circ\text{C}$ at 500°C .

MOUNTING DIMENSIONS (for reference only)

HEL-700 Ribbon Lead

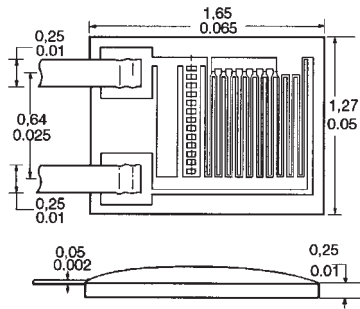

HEL-700 Radial Chip

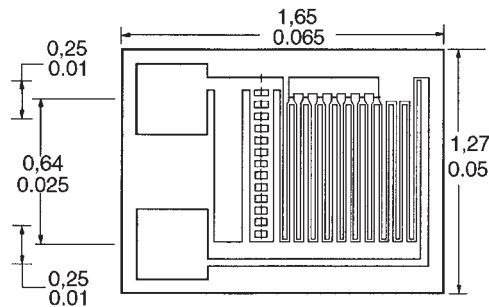

HEL-700 SMT (Axial) Flip Chip

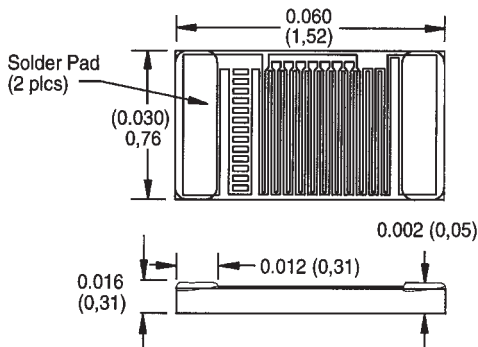

ORDER GUIDE

HEL-700	Thin Film Platinum RTD
-U	1000 Ω , 0.00375 $\Omega/\Omega/^\circ\text{C}$
-T	100 Ω , 0.00385 $\Omega/\Omega/^\circ\text{C}$ DIN Standard
-0	$\pm 0.2\%$ Resistance Trim (Standard)
-1	$\pm 0.1\%$ Resistance Trim (Optional)
-A	Radial Ribbon Lead
-B	Radial Chip
-C	SMT Axial Flip Chip (1000 Ω ONLY)

Fig. 1: Linear Output Voltage

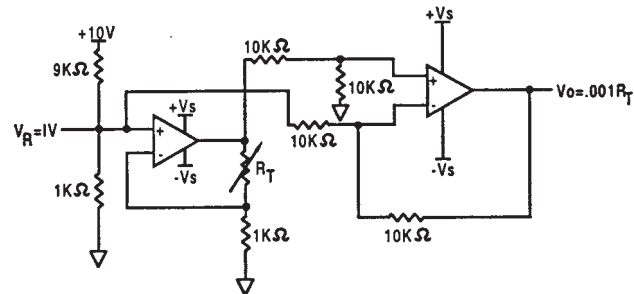
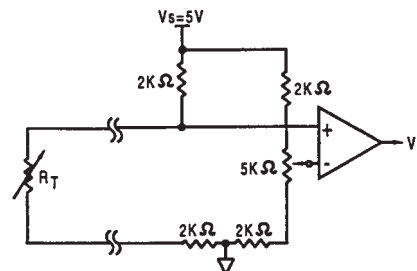

Fig. 2: Adjustable Point (Comparator) Interface



Temperature

Temperature Sensors

Platinum RTDs

HEL-700

FUNCTIONAL BEHAVIOR

$$R_T = R_0(1 + AT + BT^2 - 100CT^3 + CT^4)$$

R_T = Resistance (Ω) at temperature T ($^{\circ}\text{C}$)

R_0 = Resistance (Ω) at 0°C

T = Temperature in $^{\circ}\text{C}$

$$A = \alpha + \frac{\alpha \delta}{100} \quad B = \frac{-\alpha \delta}{100^2} \quad C_{T < 0} = \frac{-\alpha \beta}{100^4}$$

CONSTANTS

Alpha, α ($^{\circ}\text{C}^{-1}$)	0.00375 ± 0.000029	0.003850 ± 0.000010
Delta, δ ($^{\circ}\text{C}$)	1.605 ± 0.009	1.4999 ± 0.007
Beta, β ($^{\circ}\text{C}$)	0.16	0.10863
A ($^{\circ}\text{C}^{-1}$)	3.81×10^{-3}	3.908×10^{-3}
B ($^{\circ}\text{C}^{-2}$)	-6.02×10^{-7}	-5.775×10^{-7}
C ($^{\circ}\text{C}^{-4}$)	-6.0×10^{-12}	-4.183×10^{-12}

Both $\beta = 0$ and $C = 0$ for $T > 0^{\circ}\text{C}$

RESISTANCE VS TEMPERATURE CURVE

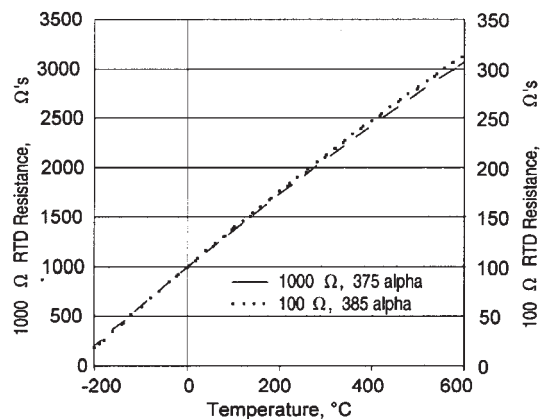

ACCURACY VS TEMPERATURE

HEL-700 platinum RTDs are available in two base resistance trim tolerances: $\pm 0.2\%$ or $\pm 0.1\%$. The corresponding resistance interchangeability and temperature accuracy for these tolerances are:

Tolerance	Standard $\pm 0.2\%$		Optional $\pm 0.1\%$	
Temperature ($^{\circ}\text{C}$)	$\pm \Delta R^*$ (Ω)	$\pm \Delta T$ ($^{\circ}\text{C}$)	$\pm \Delta R^*$ (Ω)	$\pm \Delta T$ ($^{\circ}\text{C}$)
-200	6.8	1.6	5.1	1.2
-100	2.9	0.8	2.4	0.6
0	2.0	0.5	1.0	0.3
100	2.9	0.8	2.2	0.6
200	5.6	1.6	4.3	1.2
300	8.2	2.4	6.2	1.8
400	11.0	3.2	8.3	2.5
500	12.5	4.0	9.6	3.0
600	15.1	4.8	10.4	3.3

*1000 Ω RTD. Divide ΔR by 10 for 100 Ω RTD.

CAUTION

PRODUCT DAMAGE

The inherent design of this component causes it to be sensitive to electrostatic discharge (ESD). To prevent ESD-induced damage and/or degradation, take normal ESD precautions when handling this product.

SPECIFICATIONS

Sensor Type	Thin film platinum RTD; $R_0 = 1000 \Omega @ 0^{\circ}\text{C}$; $\alpha = 0.00375 \Omega/\Omega/^{\circ}\text{C}$ $R_0 = 100 \Omega @ 0^{\circ}\text{C}$; $\alpha = 0.00385 \Omega/\Omega/^{\circ}\text{C}$
Temperature Range	-200 to $+540^{\circ}\text{C}$ (-300 to $+1000^{\circ}\text{F}$)
Temperature Accuracy	$\pm 0.5^{\circ}\text{C}$ or 0.8% of temperature, $^{\circ}\text{C}$ ($R_0 \pm 0.2\%$ trim), whichever is greater $\pm 0.3^{\circ}\text{C}$ or 0.6% of temperature, $^{\circ}\text{C}$ ($R_0 \pm 0.1\%$ trim), whichever is greater (optional)
Base Resistance and Interchangeability, $R_0 \pm \Delta R_0$	$1000 \pm 2 \Omega$ ($\pm 0.2\%$) @ 0°C $1000 \pm 1 \Omega$ ($\pm 0.1\%$) @ 0°C (optional)
Linearity	$\pm 0.1\%$ of full scale for temperatures spanning -40° to $+125^{\circ}\text{C}$ $\pm 2.0\%$ of full scale for temperatures spanning -200° to $+540^{\circ}\text{C}$
Time Constant	< 0.15 seconds in water @ 3 ft./sec. < 1 second on metal surfaces: < 4 seconds in air @ 10 ft./sec.
Operating Current	2 mA max. For self-heating errors of 1°C 1 mA recommended
Stability	Better than $0.25^{\circ}\text{C}/\text{year}$: $0.05^{\circ}\text{C}/5$ years for occupied environments
Self-Heating	0.3 mW/ $^{\circ}\text{C}$
Insulation Resistance	$> 50 \text{ M}\Omega @ 50 \text{ VDC @ } 25^{\circ}\text{C}$
Case Material	99% alumina support, vapor deposited alumina passivated resistance portion, refractory glass passivated overall
Lead Material – Ribbon	Platinum ribbon, $0.002 \times 0.010 \times 0.16$ in. long nominal
Lead Pull Strength – Ribbon	200 grams nominal pulling up from surface



FEATURES

- Linear resistance vs temperature
- Accurate and interchangeable
- Excellent stability
- Teflon or fiberglass lead wires
- Wide temperature range
- Ceramic case material

TYPICAL APPLICATIONS

- HVAC – room, duct and refrigerant equipment
- Instrument and probe assemblies – temperature compensation
- Process control – temperature regulation

HEL-700 Series elements are fully assembled, ready to use directly or in probe assemblies without the need for fragile splices to extension leads.

The 1000Ω, 375 alpha version, provides 10X greater sensitivity and signal-to-noise. Optional NIST calibrations improve accuracy to ±0.03°C at 0°C.

ORDER GUIDE

HEL-705	28 ga. TFE Teflon, 2-wire only
HEL-707	28 ga. Fiberglass, 2-wire only
HEL-711	28 ga. TFE Teflon (2-wire 1000Ω, 3-wire 100Ω)
HEL-712	28 ga. Fiberglass (2-wire 1000Ω, 3-wire 100Ω)
HEL-716	24 ga. TFE Teflon (2-wire 1000Ω, 3-wire 100Ω)
HEL-717	24 ga. Fiberglass (2-wire 1000Ω, 3-wire 100Ω)
-U	1000Ω, 0.00375 Ω/Ω/°C
-T	100Ω, 0.00385 Ω/Ω/°C DIN Standard
-0	±0.2% Resistance Trim (Standard)
-1	±0.1% Resistance Trim (Optional)
-12	Lead wire length, 12 inches
-00	No NIST calibration
-C1	NIST @ 0°C
-C2	NIST @ 0 & 100°C
-C3	NIST @ 0, 100 & 260°C

MOUNTING DIMENSIONS (for reference only)

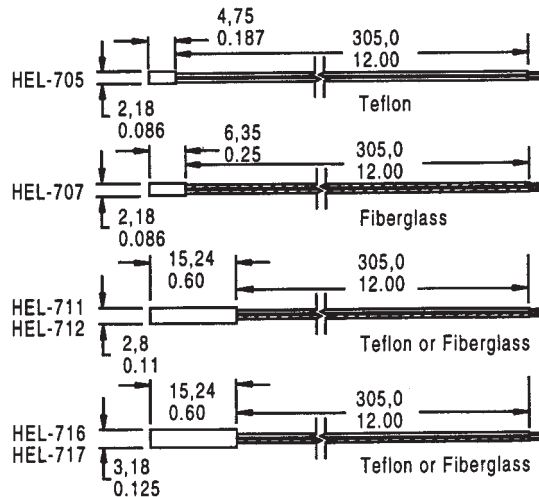

Fig. 1: Wheatstone Bridge 2-Wire Interface

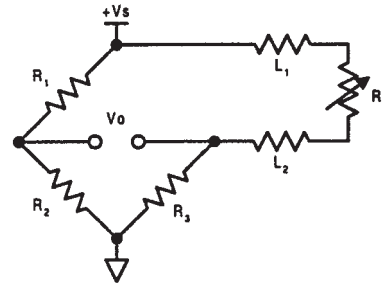

Fig. 2: Linear Output Voltage

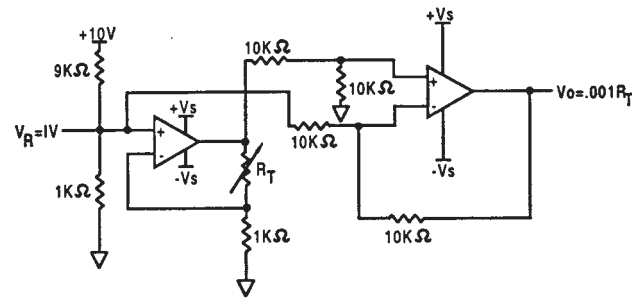
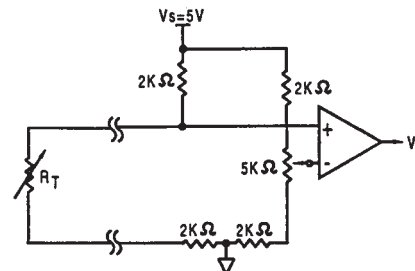

Fig. 3: Adjustable Point (Comparator) Interface



CAUTION PRODUCT DAMAGE

The inherent design of this component causes it to be sensitive to electrostatic discharge (ESD). To prevent ESD-induced damage and/or degradation, take normal ESD precautions when handling this product.

Temperature

Temperature Sensors

Platinum RTDs

HEL-700 Series

FUNCTIONAL BEHAVIOR

$$R_T = R_0(1 + AT + BT^2 - 100CT^3 + CT^4)$$

R_T = Resistance (Ω) at temperature T ($^{\circ}\text{C}$)

R_0 = Resistance (Ω) at 0°C

T = Temperature in $^{\circ}\text{C}$

$$A = \alpha + \frac{\alpha \delta}{100} \quad B = \frac{-\alpha \delta}{100^2} \quad C_{T < 0} = \frac{-\alpha \beta}{100^4}$$

CONSTANTS

Alpha, α ($^{\circ}\text{C}^{-1}$)	0.00375 ± 0.000029	0.003850 ± 0.000010
Delta, δ ($^{\circ}\text{C}$)	1.605 ± 0.009	1.4999 ± 0.007
Beta, β ($^{\circ}\text{C}$)	0.16	0.10863
A ($^{\circ}\text{C}^{-1}$)	3.81×10^{-3}	3.908×10^{-3}
B ($^{\circ}\text{C}^{-2}$)	-6.02×10^{-7}	-5.775×10^{-7}
C ($^{\circ}\text{C}^{-4}$)	-6.0×10^{-12}	-4.183×10^{-12}

Both $\beta = 0$ and $C = 0$ for $T > 0^{\circ}\text{C}$

RESISTANCE VS TEMPERATURE CURVE

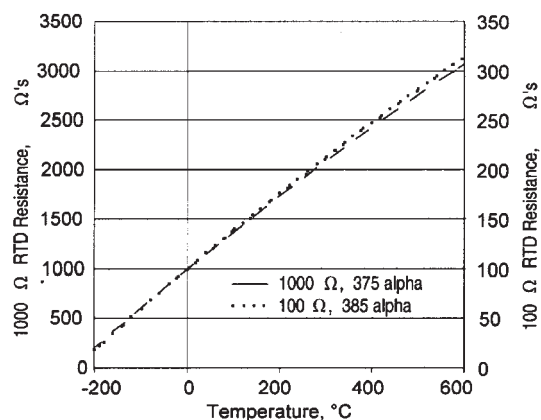

ACCURACY VS TEMPERATURE

Temperature ($^{\circ}\text{C}$)	Standard $\pm 0.2\%$		Optional $\pm 0.1\%$	
	$\pm \Delta R^*$ (Ω)	$\pm \Delta T$ ($^{\circ}\text{C}$)	$\pm \Delta R^*$ (Ω)	$\pm \Delta T$ ($^{\circ}\text{C}$)
-200	6.8	1.6	5.1	1.2
-100	2.9	0.8	2.4	0.6
0	2.0	0.5	1.0	0.3
100	2.9	0.8	2.2	0.6
200	5.6	1.6	4.3	1.2
300	8.2	2.4	6.2	1.8
400	11.0	3.2	8.3	2.5
500	12.5	4.0	9.6	3.0
600	15.1	4.8	10.4	3.3

*1000 Ω RTD. Divide Δ by 10 for 100 Ω RTD.

NIST CALIBRATION

NIST traceable calibration provides resistance readings at 1, 2 or 3 standard temperature points to yield a resistance versus temperature curve with 10x better accuracy.

Calibration	1 Point	2 Point	3 Point
T ($^{\circ}\text{C}$)	$\pm \Delta T$ ($^{\circ}\text{C}$)	$\pm \Delta T$ ($^{\circ}\text{C}$)	$\pm \Delta T$ ($^{\circ}\text{C}$)
-200	0.9	—	—
-100	0.5	0.27	0.15
0	0.03	0.03	0.03
100	0.4	0.11	0.07
200	0.8	0.2	0.08
300	1.2	0.33	6.2
400	1.6	0.5	8.3
500	2.0	0.8	9.6
600	2.6	1.2	10.4

SPECIFICATIONS

Sensor Type	Thin film platinum RTD; $R_0 = 1000 \Omega @ 0^{\circ}\text{C}$; $\alpha = 0.00375 \Omega/\Omega/^{\circ}\text{C}$ $R_0 = 100 \Omega @ 0^{\circ}\text{C}$; $\alpha = 0.00385 \Omega/\Omega/^{\circ}\text{C}$
Temperature Range	TFE Teflon: -200° to $+260^{\circ}\text{C}$ (-320° to $+500^{\circ}\text{F}$) Fiberglass: -75° to $+540^{\circ}\text{C}$ (-100° to $+1000^{\circ}\text{F}$)
Temperature Accuracy	$\pm 0.5^{\circ}\text{C}$ or 0.8% of temperature, $^{\circ}\text{C}$ ($R_0 \pm 0.2\%$ trim), whichever is greater $\pm 0.3^{\circ}\text{C}$ or 0.6% of temperature, $^{\circ}\text{C}$ ($R_0 \pm 0.1\%$ trim), whichever is greater (optional)
Base Resistance and Interchangeability, $R_0 \pm \Delta R_0$	$1000 \pm 2 \Omega$ ($\pm 0.2\%$) @ 0°C $1000 \pm 1 \Omega$ ($\pm 0.1\%$) @ 0°C (optional)
Linearity	$\pm 0.1\%$ of full scale for temperatures spanning -40° to $+125^{\circ}\text{C}$ $\pm 2.0\%$ of full scale for temperatures spanning -75° to $+540^{\circ}\text{C}$
Time Constant	< 0.5 sec. 0.85 inch O.D. in water at 3 ft/sec; < 1.0 sec, 0.85 inch O.D. in still water
Operating Current	2 mA maximum for self heating errors of $< 1^{\circ}\text{C}$; 1 mA recommended
Stability	$< 0.25^{\circ}\text{C}/\text{year}$; 0.05°C per 5 years in occupied environments
Self Heating	< 15 mW/ $^{\circ}\text{C}$ for 0.85 O.D. typical
Insulation Resistance	> 50 M Ω at 50 VDC at 25°C
Construction	Alumina case; Epoxy potting (Teflon leads); Ceramic potting (fiberglass leads)
Lead Material	Nickel coated stranded copper, Teflon or Fiberglass insulated