

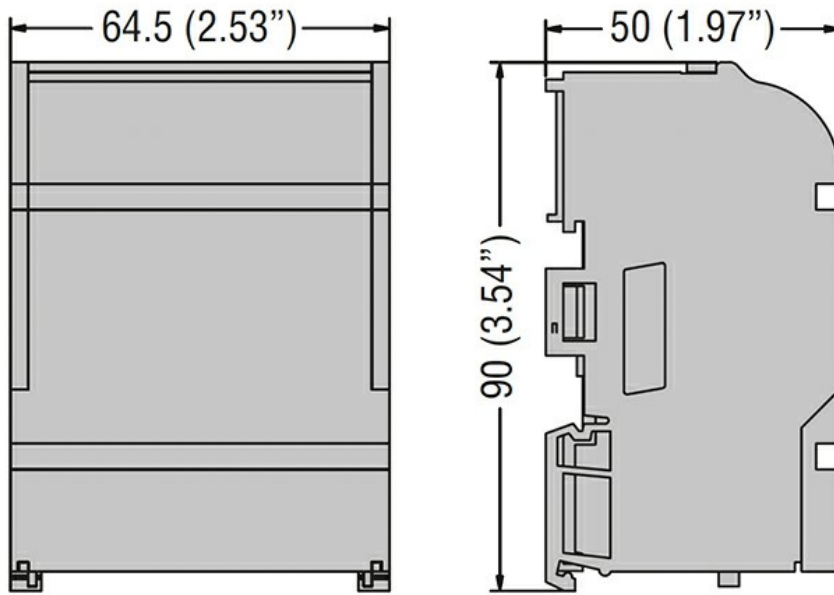

Product designation	Power distribution block	
Electrical features		
Number of poles	4	
Rated insulation voltage U_i	V	500
IEC Conventional free air thermal current $I_{th} \leq 40^\circ\text{C}$	A	100
Rated peak withstand current I_{pk}	kA	20
Rated short time current $I_{cw} 1s$	kA	4.5
Connections		
Terminal hole diameter_Option 1	mm	1x8.5mm
Conductor section connectable_Option 1	mm ²	10...25
Tightening torque Max_Option 1	Nm	2
	lbin	18
Terminal hole diameter_Option 2	mm	3x5.5mm
Conductor section connectable_Option 2	mm ²	2.5...6
Tightening torque Max_Option 2	Nm	2
	lbin	18
Terminal hole diameter_Option 3	mm	3x4.5mm
Conductor section connectable_Option 3	mm ²	1.5...4
Tightening torque Max_Option 3	Nm	1.2
	lbin	11
Mechanical features		
Operating position	normal allowable	Vertical plane
		Any
Fixing	Screw / DIN rail 35mm	
Phillips	2	
Weight	g	238
Resistance & Protection		
Terminals IP degree	IP20 front	
Dimensions		



Certifications and compliance

Certifications

IEC/EN/BS 60947-7-1

Compliance

TÜV

ETIM classification

EC000066 - Power contactor, AC switching